



target | T2S services

Target2-Securities

User Handbook

V5.2

5 June 2020

Disclaimer

All rights reserved. Reproduction for educational and non-commercial purposes is permitted provided that the source is acknowledged.

Table of Contents

	Disclaimer	2
	Terms and Abbreviations.....	39
1	Introduction	40
1.1	Overview of the User Handbook	40
1.1.1	UHB Methodology	Error! Bookmark not defined.
1.1.2	UHB Structure	Error! Bookmark not defined.
1.2	Overview of the Graphical User Interface.....	Error! Bookmark not defined.
1.2.1	Setup and Login Procedures.....	Error! Bookmark not defined.
1.2.2	GUI Structure.....	Error! Bookmark not defined.
1.2.2.1	Menu Structure	Error! Bookmark not defined.
1.2.2.2	Screen Structure.....	Error! Bookmark not defined.
1.2.2.3	Screen Types	Error! Bookmark not defined.
1.2.2.4	Field Types and Properties	Error! Bookmark not defined.
1.2.2.5	Common Buttons and Icons.....	Error! Bookmark not defined.
1.2.3	Validation	Error! Bookmark not defined.
1.2.4	Communication Network and Services	Error! Bookmark not defined.
1.2.5	User Administration	Error! Bookmark not defined.
1.2.6	Security and Certification Service	Error! Bookmark not defined.
1.2.7	Online Help	Error! Bookmark not defined.
2	Open Reference Part	41
2.1	General	41
2.2	Securities.....	41
2.2.1	Securities Account.....	41
2.2.1.1	Securities Positions - Search/List Screen	Error! Bookmark not defined.
2.2.1.2	Securities Position - Details Screen..	Error! Bookmark not defined.
2.2.1.3	Securities Postings - Search/List Screen	Error! Bookmark not defined.
2.2.1.4	Securities Restriction Details - Search/List Screen	Error! Bookmark not defined.
2.2.2	Settlement	Error! Bookmark not defined.
2.2.2.1	Allegement Instructions - Search/List Screen..	Error! Bookmark not defined.
2.2.2.2	Allegement Instruction - Details Screen	Error! Bookmark not defined.

	defined.	
2.2.2.3	Amendment Securities Instruction - Details Screen	Error! Bookmark not defined.
2.2.2.4	Amendment Securities Instruction - New Screen ...	Error! Bookmark not defined.
2.2.2.5	Cancellation Securities Instruction - Details Screen	Error! Bookmark not defined.
2.2.2.6	Cancellation Securities Instruction - New Screen...	Error! Bookmark not defined.
2.2.2.7	Data Changes - Search/List Screen..	Error! Bookmark not defined.
2.2.2.8	Data Change - Details Screen	Error! Bookmark not defined.
2.2.2.9	Hold/Release Instruction - Details Screen.....	Error! Bookmark not defined.
2.2.2.10	Hold/Release Instruction - New Screen	Error! Bookmark not defined.
2.2.2.11	Intra-Position Movements - Search/List Screen	Error! Bookmark not defined.
2.2.2.12	Intra-Position Movement - Details Screen.....	Error! Bookmark not defined.
2.2.2.13	Intra-Position Movement - New Screen.....	Error! Bookmark not defined.
2.2.2.14	Maintenance Securities Instructions - Search/List Screen.....	Error! Bookmark not defined.
2.2.2.15	Securities Positions - Search/List Screen	Error! Bookmark not defined.
2.2.2.16	Securities Position - Details Screen ..	Error! Bookmark not defined.
2.2.2.17	Settlement Instructions - Search/List Screen ..	Error! Bookmark not defined.
2.2.2.18	Settlement Instruction - Details Screen.....	Error! Bookmark not defined.
2.2.2.19	Settlement Instruction - New Screen.	Error! Bookmark not defined.
2.2.2.20	Status History - Details Screen	Error! Bookmark not defined.
2.2.2.21	Insolvency procedure Settlement Instructions - Search/List Screen	Error! Bookmark not defined.
2.2.2.22	Links Preventing Settlement - List Screen	Error! Bookmark not defined.
2.2.2.23	Penalty – Search/List Screen.....	Error! Bookmark not defined.
2.2.2.24	Penalty - Details Screen	Error! Bookmark not defined.
2.2.2.25	Monthly Net Penalty Amounts - Search/List Screen.....	Error! Bookmark not defined.
2.2.2.26	Penalty - Removal Screen	Error! Bookmark not defined.
2.2.2.27	Penalty - Re-allocation Screen	Error! Bookmark not defined.

2.2.2.28	Penalty - Switch Screen.....	Error! Bookmark not defined.
2.3	Cash	Error! Bookmark not defined.
2.3.1	Cash Account.....	Error! Bookmark not defined.
2.3.1.1	Cash Forecasts - Search/List Screen	Error! Bookmark not defined.
2.3.1.2	Cash Forecast - Details Screen	Error! Bookmark not defined.
2.3.1.3	Cash Restriction Details - Search/List Screen.	Error! Bookmark not defined.
2.3.1.4	Collateral Values of a Security - Search/List Screen	Error! Bookmark not defined.
2.3.1.5	Collateral Values per T2S Dedicated Cash Account and Security - Search/List Screen	Error! Bookmark not defined.
2.3.1.6	Limits - Search/list Screen	Error! Bookmark not defined.
2.3.1.7	Limit - New/Edit Screen	Error! Bookmark not defined.
2.3.1.8	Limit Utilisation - Search/List Screen	Error! Bookmark not defined.
2.3.1.9	Limit Utilisation Journal - Search/List Screen..	Error! Bookmark not defined.
2.3.1.10	T2S DCA Balances - Search/List Screen.....	Error! Bookmark not defined.
2.3.1.11	T2S DCA Balance - Details Screen ..	Error! Bookmark not defined.
2.3.1.12	T2S DCA Postings - Search/List Screen.....	Error! Bookmark not defined.
2.3.1.13	Total Collateral Values per T2S Dedicated Cash Account - Search/List Screen.....	Error! Bookmark not defined.
2.3.2	Liquidity	Error! Bookmark not defined.
2.3.2.1	Data Changes - Search/List Screen..	Error! Bookmark not defined.
2.3.2.2	Data Change - Details Screen	Error! Bookmark not defined.
2.3.2.3	Immediate Liquidity Transfers - Search/List Screen.....	Error! Bookmark not defined.
2.3.2.4	Immediate Liquidity Transfer - Details Screen.	Error! Bookmark not defined.
2.3.2.5	Immediate Liquidity Transfer - New Screen	Error! Bookmark not defined.
2.3.2.6	Outstanding Auto-Collateralisation Credits - Search/List Screen	Error! Bookmark not defined.
2.3.2.7	Overall Liquidity - Search/List Screen	Error! Bookmark not defined.
2.3.2.8	Standing/Predefined Liquidity Transfer Orders - Search/List Screen	Error! Bookmark not defined.
2.3.2.9	Standing/Predefined Liquidity Transfer Order - Details Screen	Error! Bookmark not defined.
2.3.2.10	Standing/Predefined Liquidity Transfer Order - New/Edit Screen	Error! Bookmark not defined.

2.3.2.11	Standing/Predefined Liquidity Transfer Order Link Sets - Search/List Screen	Error! Bookmark not defined.
2.3.2.12	Standing/Predefined Liquidity Transfer Order Link Set - Details Screen	Error! Bookmark not defined.
2.3.2.13	Standing/Predefined Liquidity Transfer Order Link Set - New/Edit Screen	Error! Bookmark not defined.
2.3.2.14	Total Amount of Standing/Predefined Liquidity Transfer Orders - Search/List Screen.....	Error! Bookmark not defined.
2.3.3	Settlement	Error! Bookmark not defined.
2.3.3.1	Amendment Cash Instruction - Details Screen	Error! Bookmark not defined.
2.3.3.2	Amendment Cash Instruction - New Screen ...	Error! Bookmark not defined.
2.3.3.3	Cancellation Cash Instruction - Details Screen	Error! Bookmark not defined.
2.3.3.4	Cancellation Cash Instruction - New Screen...	Error! Bookmark not defined.
2.3.3.5	Intra-Balance Movements - Search/List Screen.....	Error! Bookmark not defined.
2.3.3.6	Intra-Balance Movement - Details Screen.....	Error! Bookmark not defined.
2.3.3.7	Intra-Balance Movement - New Screen	Error! Bookmark not defined.
2.3.3.8	Maintenance Cash Instructions - Search/List Screen.....	Error! Bookmark not defined.
2.3.3.9	Status History - Details Screen	Error! Bookmark not defined.
2.4	Services	41
2.4.1	Additional Services	41
2.4.1.1	Available Reports - Search/List Screen.....	41
2.4.1.2	Available Report - Details Screen	Error! Bookmark not defined.
2.4.1.3	Available Report - Current Settlement Day Cash Information (Following Settlement Day Cash Forecast) Report - Details Screen	Error! Bookmark not defined.
2.4.1.4	Available Report - Statement of Accounts - Details Screen.....	Error! Bookmark not defined.
2.4.1.5	Available Report - Statement of Executed Amendment Instructions for Intra-Balance Movements - Details Screen	Error! Bookmark not defined.
2.4.1.6	Available Report - Statement of Executed Amendment Instructions for Intra-Position Movements and Settlement Instructions - Details Screen	Error! Bookmark not defined.

2.4.1.7	Available Report - Statement of Executed Cancellation Instructions for Intra-Balance Movements - Details Screen Error! Bookmark not defined.
2.4.1.8	Available Report - Statement of Executed Cancellation Instructions for Intra-Position Movements and Settlement Instructions - Details Screen Error! Bookmark not defined.
2.4.1.9	Available Report - Statement of Holdings - Details Screen Error! Bookmark not defined.
2.4.1.10	Available Report - Statement of Pending Amendment Instructions for Intra-Balance Movements - Details Screen Error! Bookmark not defined.
2.4.1.11	Available Report - Statement of Pending Amendment Instructions for Intra-Position Movements and Settlement Instructions - Details Screen Error! Bookmark not defined.
2.4.1.12	Available Report - Statement of Pending Cancellation Instructions for Intra-Balance Movements - Details Screen Error! Bookmark not defined.
2.4.1.13	Available Report - Statement of Pending Cancellation Instructions for Intra-Position Movements and Settlement Instructions - Details Screen Error! Bookmark not defined.
2.4.1.14	Available Report - Statement of Pending Instructions - Details Screen Error! Bookmark not defined.
2.4.1.15	Available Report - Statement of Pending Intra-Balance Movements - Details Screen Error! Bookmark not defined.
2.4.1.16	Available Report - Statement of Pending Intra-Position Movements - Details Screen Error! Bookmark not defined.
2.4.1.17	Available Report - Statement of Settled Intra-Balance Movements - Details Screen Error! Bookmark not defined.
2.4.1.18	Available Report - Statement of Settled Intra-Position Movements - Details Screen Error! Bookmark not defined.
2.4.1.19	Available Report - Statement of Settlement Allegements - Details Screen Error! Bookmark not defined.
2.4.1.20	Available Report - Statement of Static Data - Details Screen... Error! Bookmark not defined.
2.4.1.21	Available Report - Statement of Transactions - Details Screen Error! Bookmark not defined.
2.4.1.22	Available Report – Daily Penalty List – Details Screen Error! Bookmark not defined.
2.4.1.23	Available Report – List of Modified Penalties - Details Screen. Error! Bookmark not defined.
2.4.1.24	Available Report – Monthly Aggregated Amounts – Details Screen Error! Bookmark not defined.

2.4.1.25	Cumulative Billing Data - Search/List Screen..	Error! Bookmark not defined.	
2.4.1.26	Cumulative Billing Data - Details Screen.....	Error! Bookmark not defined.	
2.4.1.27	Daily Schedules - Search/List Screen.....		43
2.4.1.28	Data Changes - Search/List Screen		47
2.4.1.29	Data Change - Details Screen		47
2.4.1.30	Itemised Billing Data - Search/List Screen		47
2.4.1.31	Itemised Billing Data - Details Screen.....		47
2.4.1.32	Queued Static Data Changes - Search/List Screen		47
2.4.1.33	Queued Static Data Change - Details Screen.....		47
2.4.1.34	T2S Calendar Screen.....		47
2.4.1.35	User Access Rights - Search Screen.....		50
2.4.1.36	User Access Rights - List Screen.....		50
2.4.2	Communication.....		50
2.4.2.1	Broadcasts - Search/List Screen.....		50
2.4.2.2	Broadcast - Details Screen	Error! Bookmark not defined.	
2.4.2.3	Broadcast - New Screen.....	Error! Bookmark not defined.	
2.4.2.4	Inbound Files - Search/List Screen...	Error! Bookmark not defined.	
2.4.2.5	Inbound File - Details Screen.....	Error! Bookmark not defined.	
2.4.2.6	Inbound Messages - Search/List Screen	Error! Bookmark not defined.	
2.4.2.7	Inbound Message - Details Screen...	Error! Bookmark not defined.	
2.4.2.8	Outbound Files - Search/List Screen	Error! Bookmark not defined.	
2.4.2.9	Outbound File - Details Screen.....	Error! Bookmark not defined.	
2.4.2.10	Outbound Messages - Search/List Screen.....	Error! Bookmark not defined.	
2.4.2.11	Outbound Message - Details Screen	Error! Bookmark not defined.	
2.4.2.12	Resend Communication Screen	Error! Bookmark not defined.	
2.5	Static Data.....		50
2.5.1	Parties	50	
2.5.1.1	Eligible Counterpart CSDs - Search/List Screen....	Error! Bookmark not defined.	
2.5.1.2	Eligible Counterpart CSD - Details Screen.....	Error! Bookmark not defined.	
2.5.1.3	Eligible Counterpart CSD - New/Edit Screen ..	Error! Bookmark not defined.	
2.5.1.4	Parties - Search/List Screen	Error! Bookmark not defined.	
2.5.1.5	Party - Details Screen.....	Error! Bookmark not defined.	
2.5.1.6	Party - New/Edit Screen	Error! Bookmark not defined.	
2.5.1.7	Restricted Parties - Search/List Screen	Error! Bookmark not defined.	

	defined.	
2.5.1.8	Technical Addresses Network Services Link - Details Screen .	Error! Bookmark not defined.
2.5.1.9	Technical Addresses Network Services Link - New/Edit Screen	Error! Bookmark not defined.
2.5.2	Securities	Error! Bookmark not defined.
2.5.2.1	Auto-Collateralisation Eligibility Links - Search/List Screen.....	Error! Bookmark not defined.
2.5.2.2	Auto-Collateralisation Eligibility Link - New Screen	Error! Bookmark not defined.
2.5.2.3	Close Links - Search/List Screen.....	Error! Bookmark not defined.
2.5.2.4	Close Link - New Screen	Error! Bookmark not defined.
2.5.2.5	Securities - Search/List Screen.....	Error! Bookmark not defined.
2.5.2.6	Security - Details Screen	Error! Bookmark not defined.
2.5.2.7	Security - New/Edit Screen	Error! Bookmark not defined.
2.5.2.8	Securities Valuations - Search/List Screen	Error! Bookmark not defined.
2.5.2.9	Securities Valuation - New Screen....	Error! Bookmark not defined.
2.5.2.10	Security CSD Links - Search/List Screen.....	Error! Bookmark not defined.
2.5.2.11	Security CSD Link - Details Screen ..	Error! Bookmark not defined.
2.5.2.12	Security CSD Link - New/Edit Screen	Error! Bookmark not defined.
2.5.3	Securities Account.....	Error! Bookmark not defined.
2.5.3.1	CSD Account Links - Search/List Screen.....	Error! Bookmark not defined.
2.5.3.2	CSD Account Link - New/Edit Screen	Error! Bookmark not defined.
2.5.3.3	Securities Accounts - Search/List Screen	Error! Bookmark not defined.
2.5.3.4	Securities Account - Details Screen..	Error! Bookmark not defined.
2.5.3.5	Securities Account - New/Edit Screen	Error! Bookmark not defined.
2.5.3.6	Securities Account Transfer Management - Edit Screen.....	Error! Bookmark not defined.
2.5.3.7	Securities Accounts Links - Search/List Screen	Error! Bookmark not defined.
2.5.3.8	Securities Accounts Link - New/Edit Screen ...	Error! Bookmark not defined.
2.5.4	T2S Dedicated Cash Account.....	Error! Bookmark not defined.
2.5.4.1	CMBs - Search/List Screen.....	Error! Bookmark not defined.
2.5.4.2	CMB - Details Screen	Error! Bookmark not defined.
2.5.4.3	CMB - New/Edit Screen.....	Error! Bookmark not defined.

2.5.4.4	External RTGS Accounts - Search/List Screen	Error! Bookmark not defined.
2.5.4.5	External RTGS Account - Details Screen.....	Error! Bookmark not defined.
2.5.4.6	External RTGS Account - New/Edit Screen	Error! Bookmark not defined.
2.5.4.7	Limits - Search/List Screen	Error! Bookmark not defined.
2.5.4.8	Limit - New/Edit Screen	Error! Bookmark not defined.
2.5.4.9	Standing/Predefined Liquidity Transfer Orders - Search/List Screen	Error! Bookmark not defined.
2.5.4.10	Standing/Predefined Liquidity Transfer Order - Details Screen	Error! Bookmark not defined.
2.5.4.11	Standing/Predefined Liquidity Transfer Order - New/Edit Screen	Error! Bookmark not defined.
2.5.4.12	Standing/Predefined Liquidity Transfer Order Link Sets - Search/List Screen	Error! Bookmark not defined.
2.5.4.13	Standing/Predefined Liquidity Transfer Order Link Set - Details Screen	Error! Bookmark not defined.
2.5.4.14	Standing/Predefined Liquidity Transfer Order Link Set - New/Edit Screen	Error! Bookmark not defined.
2.5.4.15	T2S Dedicated Cash Accounts - Search/List Screen	Error! Bookmark not defined.
2.5.4.16	T2S Dedicated Cash Account - Details Screen	Error! Bookmark not defined.
2.5.4.17	T2S Dedicated Cash Account - New/Edit Screen ..	Error! Bookmark not defined.
2.5.5	Scheduling	Error! Bookmark not defined.
2.5.5.1	Event Types - Search/List Screen.....	Error! Bookmark not defined.
2.5.5.2	Event Type - Details Screen	Error! Bookmark not defined.
2.5.5.3	Working/Closing Days - Search/List Screen ...	Error! Bookmark not defined.
2.5.6	Access Rights	Error! Bookmark not defined.
2.5.6.1	Certificate Distinguished Names - Search/List Screen	Error! Bookmark not defined.
2.5.6.2	Certificate Distinguished Name - New Screen	Error! Bookmark not defined.
2.5.6.3	Grant/Revoke Privileges - Search Screen.....	Error! Bookmark not defined.
2.5.6.4	Grant/Revoke Cross-System Entity Object Privilege - Details Screen	Error! Bookmark not defined.
2.5.6.5	Grant/Revoke Cross-System Entity Object Privilege - New/Edit	

	Screen	Error! Bookmark not defined.
2.5.6.6	Grant/Revoke Object Privilege - Details Screen.....	Error! Bookmark not defined.
2.5.6.7	Grant/Revoke Object Privilege - New/Edit Screen .	Error! Bookmark not defined.
2.5.6.8	Grant/Revoke Roles - Search/List Screen	Error! Bookmark not defined.
2.5.6.9	Grant/Revoke Role - Details Screen .	Error! Bookmark not defined.
2.5.6.10	Grant/Revoke Role - New/Edit Screen.....	Error! Bookmark not defined.
2.5.6.11	Grant/Revoke System Privilege - Details Screen ...	Error! Bookmark not defined.
2.5.6.12	Grant/Revoke System Privilege - New/Edit Screen	Error! Bookmark not defined.
2.5.6.13	Privileges - Search/List Screen.....	Error! Bookmark not defined.
2.5.6.14	Roles - Search/List Screen	Error! Bookmark not defined.
2.5.6.15	Role - New/Edit Screen	Error! Bookmark not defined.
2.5.6.16	Secured Groups - Search/List Screen.....	Error! Bookmark not defined.
2.5.6.17	Secured Group - Details Screen	Error! Bookmark not defined.
2.5.6.18	Secured Group - New/Edit Screen....	Error! Bookmark not defined.
2.5.6.19	Users - Search/List Screen	Error! Bookmark not defined.
2.5.6.20	User - Details Screen.....	Error! Bookmark not defined.
2.5.6.21	User - New/Edit Screen	Error! Bookmark not defined.
2.5.6.22	User Certificate Distinguished Name Links - Search/List Screen	Error! Bookmark not defined.
2.5.6.23	User Certificate Distinguished Name Link - New Screen	Error! Bookmark not defined.
2.5.7	Messages and Reports	Error! Bookmark not defined.
2.5.7.1	Message Subscription Rules - List Screen.....	Error! Bookmark not defined.
2.5.7.2	Message Subscription Rule - New/Edit Screen	Error! Bookmark not defined.
2.5.7.3	Message Subscription Rule Sets - Search/List Screen	Error! Bookmark not defined.
2.5.7.4	Message Subscription Rule Set - Details Screen...	Error! Bookmark not defined.
2.5.7.5	Message Subscription Rule Set - New/Edit Screen	Error! Bookmark not defined.
2.5.7.6	Report Configurations - Search/List Screen....	Error! Bookmark not defined.
2.5.7.7	Report Configuration - Details Screen	Error! Bookmark not defined.

	defined.	
2.5.7.8	Report Configuration - New/Edit Screen	Error! Bookmark not defined.
2.5.8	Network Configuration.....	Error! Bookmark not defined.
2.5.8.1	Network Services - Search/List Screen.....	Error! Bookmark not defined.
2.5.8.2	Routing - Search/List Screen	Error! Bookmark not defined.
2.5.8.3	Routing - New/Edit Screen.....	Error! Bookmark not defined.
2.5.8.4	T2S BIC Directory Items - Search/List Screen	Error! Bookmark not defined.
2.5.9	Market-Specific Configuration	Error! Bookmark not defined.
2.5.9.1	CoSD Rules - Search/List Screen....	Error! Bookmark not defined.
2.5.9.2	CoSD Rule - New/Edit Screen	Error! Bookmark not defined.
2.5.9.3	CoSD Rule Sets - Search/List Screen.....	Error! Bookmark not defined.
2.5.9.4	CoSD Rule Set - New/Edit Screen....	Error! Bookmark not defined.
2.5.9.5	Market-Specific Attributes - Search/List Screen	Error! Bookmark not defined.
2.5.9.6	Market-Specific Attribute - Details Screen.....	Error! Bookmark not defined.
2.5.9.7	Market-Specific Attribute - New/Edit Screen ...	Error! Bookmark not defined.
2.5.9.8	Restriction Types - Search/List Screen	Error! Bookmark not defined.
2.5.9.9	Restriction Type - New/Edit Screen ..	Error! Bookmark not defined.
2.5.9.10	Restriction Type Rule Sets - List Screen.....	Error! Bookmark not defined.
2.5.9.11	Restriction Type Rule - Details Screen	Error! Bookmark not defined.
2.5.9.12	Restriction Type Rule - New/Edit Screen	Error! Bookmark not defined.
2.5.10	General Configuration Parameters	Error! Bookmark not defined.
2.5.10.1	Attribute Domains - Search/List Screen	Error! Bookmark not defined.
2.5.10.2	Attribute Domain - Details Screen.....	Error! Bookmark not defined.
2.5.10.3	Attribute Domain - New/Edit Screen .	Error! Bookmark not defined.
2.5.10.4	Attribute Domain References - List Screen	Error! Bookmark not defined.
2.5.10.5	Attribute Domain Reference - Details Screen..	Error! Bookmark not defined.
2.5.10.6	Attribute Domain Reference - New/Edit Screen	Error! Bookmark not defined.

	not defined.	
2.5.10.7	Countries - Search/List Screen	Error! Bookmark not defined.
2.5.10.8	Currencies - Search/List Screen	Error! Bookmark not defined.
2.5.10.9	Partial Settlement Thresholds - Search/List Screen	Error!
	Bookmark not defined.	
2.5.10.10	Service Items - Search/List Screen...	Error! Bookmark not defined.
2.5.10.11	Service Item - Details Screen	Error! Bookmark not defined.
2.5.10.12	System Entities - Search/List Screen	Error! Bookmark not defined.
2.5.10.13	Tolerance Amounts - Search/List Screen.....	Error! Bookmark not defined.
2.5.11	Revisions	Error! Bookmark not defined.
2.5.11.1	Revisions/Audit Trail - List Screen	Error! Bookmark not defined.
2.5.11.2	Revisions/Audit Trail - Details Screen.....	Error! Bookmark not defined.
2.5.11.3	Static Data Revisions - Search/List Screen.....	Error! Bookmark not defined.
2.5.12	Penalty Reference Data	Error! Bookmark not defined.
2.5.12.1	Securities Subject to Cash Penalties – Search/List Screen.....	Error!
	Bookmark not defined.	
2.5.12.2	Securities subject to Cash Penalties – New/Edit Screen.....	Error!
	Bookmark not defined.	
2.5.12.3	Security Penalty Rate – Search/List Screen ...	Error! Bookmark not defined.
2.5.12.4	Cash Discount Penalty Rate – Search/List Screen	Error! Bookmark not defined.
2.5.12.5	Euro Foreign Exchange Reference Rate – Search/List Screen	Error!
	Bookmark not defined.	
2.5.12.6	Euro Foreign Exchange Reference Rate – New/Edit Screen ...	Error!
	Bookmark not defined.	
2.5.12.7	Daily Price – Search List Screen.....	Error! Bookmark not defined.
2.5.12.8	Daily Price – New/Edit Screen	Error! Bookmark not defined.
2.5.12.9	SME Growth Market – Search/List Screen.....	Error! Bookmark not defined.
	defined.	
2.6	Monitoring	50
2.6.1	Monitoring	50
2.6.1.1	Securities Positions - Search/List Screen	50
2.6.1.2	Securities Position - Details Screen	50
2.6.1.3	T2S Calendar Screen	50
2.6.1.4	T2S DCA Balances - Search/List Screen.....	50
2.6.1.5	T2S DCA Balance - Details Screen	51
2.7	Business Day Management	Error! Bookmark not defined.

2.7.1	Settlement Day	Error! Bookmark not defined.
2.7.1.1	Settlement Day - Search/List Screen	Error! Bookmark not defined.
2.7.2	Calendar	Error! Bookmark not defined.
2.7.1.3	Calendar – Details Screen	Error! Bookmark not defined.
3	r Instructions Part	57
3.1	General	57
3.2	Access Rights	Error! Bookmark not defined.
3.2.1	Configuration of a Role	Error! Bookmark not defined.
3.2.1.1	Create a New Role	Error! Bookmark not defined.
3.2.1.2	Grant System and Object Privileges to a Role	Error! Bookmark not defined.
3.2.1.3	Assign a Role to a Party	Error! Bookmark not defined.
3.2.1.4	Assign a Role to a User	Error! Bookmark not defined.
3.2.2	Configuration of a Privilege (Two-Step Approach)	Error! Bookmark not defined.
3.2.2.1	Grant a Privilege to a Party.....	Error! Bookmark not defined.
3.2.2.2	Grant a Privilege to a User.....	Error! Bookmark not defined.
3.2.2.3	View Privilege Details	Error! Bookmark not defined.
3.2.3	Configuration of a Secured Group	Error! Bookmark not defined.
3.2.3.1	Create a New Secured Group.....	Error! Bookmark not defined.
3.2.3.2	Assign a Secured Object to a Secured Group.	Error! Bookmark not defined.
3.2.4	Configuration of a User	Error! Bookmark not defined.
3.2.4.1	Create a New User	Error! Bookmark not defined.
3.2.4.2	Create a New User Certificate Distinguished Name.....	Error! Bookmark not defined.
3.2.4.3	Create a New User Certificate Distinguished Name Link	Error! Bookmark not defined.
3.2.4.4	Grant a Privilege to a User.....	Error! Bookmark not defined.
3.2.4.5	Assign a Role to a User	Error! Bookmark not defined.
3.2.5	Usage of the 4-Eyes Mode	Error! Bookmark not defined.
3.2.5.1	Initiate an Action in 4-Eyes Mode.....	Error! Bookmark not defined.
3.2.5.2	Approve an Action in 4-Eyes Mode...	Error! Bookmark not defined.
3.3	Communication	Error! Bookmark not defined.
3.3.1	Usage of Broadcasts	Error! Bookmark not defined.
3.3.1.1	Create a New Broadcast.....	Error! Bookmark not defined.
3.3.1.2	View a Broadcast.....	Error! Bookmark not defined.
3.3.2	Monitoring of Communication	Error! Bookmark not defined.

3.3.2.1	Resend Communication	Error! Bookmark not defined.
3.3.2.2	View Inbound Communication	Error! Bookmark not defined.
3.3.2.3	View Outbound Communication.....	Error! Bookmark not defined.
3.4	Rule Sets.....	Error! Bookmark not defined.
3.4.1	Configuration of a New CoSD Rule Set	Error! Bookmark not defined.
3.4.1.1	Create a New CoSD Rule Set.....	Error! Bookmark not defined.
3.4.2	Configuration of a New Message Subscription Rule Set...	Error! Bookmark not defined.
3.4.2.1	Create a New Message Subscription Rule Set	Error! Bookmark not defined.
3.5	Liquidity Transfers	Error! Bookmark not defined.
3.5.1	Creation of a New Immediate Liquidity Transfer Order	Error! Bookmark not defined.
3.5.1.1	Create a New Immediate Liquidity Transfer Order .	Error! Bookmark not defined.
3.5.1.2	Copy an Immediate Liquidity Transfer Order...	Error! Bookmark not defined.
3.5.2	Creation of a New Standing/Predefined Liquidity Transfer Order	Error! Bookmark not defined.
3.5.2.1	Create a New Standing/Predefined Liquidity Transfer Order....	Error! Bookmark not defined.
3.5.2.2	Create a New Liquidity Transfer Order Link Set.....	Error! Bookmark not defined.
3.6	Market-Specific Attributes	Error! Bookmark not defined.
3.6.1	Configuration of a New Market-Specific Attribute	Error! Bookmark not defined.
3.6.1.1	Create a New Market-Specific Attribute	Error! Bookmark not defined.
3.6.1.2	Create a New Attribute Domain	Error! Bookmark not defined.
3.6.2	Assignment of a Market-Specific Attribute Value	Error! Bookmark not defined.
3.6.2.1	Assign a Market-Specific Attribute Value to a Party	Error! Bookmark not defined.
3.6.2.2	Assign a Market-Specific Attribute Value to a Security.....	Error! Bookmark not defined.
3.6.2.3	Assign a Market-Specific Attribute Value to a Securities Account	Error! Bookmark not defined.
3.7	Cash and Settlement Monitoring.....	Error! Bookmark not defined.
3.7.1	Monitoring of Cash, Collateral and Limits Situation....	Error! Bookmark not defined.

	defined.	
3.7.1.1	View Cash Balances Details and Related Postings	Error! Bookmark not defined.
3.7.1.2	View Cash Balances Details and Related Restrictions.....	Error! Bookmark not defined.
3.7.1.3	View Immediate Liquidity Transfer Order Details ...	Error! Bookmark not defined.
3.7.1.4	View Standing/Predefined Liquidity Transfer Order Details.....	Error! Bookmark not defined.
3.7.1.5	View Overall Liquidity	Error! Bookmark not defined.
3.7.1.6	Change the Limit of a Payment Bank	Error! Bookmark not defined.
3.7.1.7	Reimburse an Outstanding Intraday Credit	Error! Bookmark not defined.
3.7.2	Monitoring of Securities Positions	Error! Bookmark not defined.
3.7.2.1	View Current Securities Positions and Related Postings.....	Error! Bookmark not defined.
3.7.2.2	View Current Securities Positions and Related Restrictions.....	Error! Bookmark not defined.
3.7.2.3	View Historic Securities Positions for a Specific Date	Error! Bookmark not defined.
3.7.2.4	View Historic Securities Positions for a Specific Period	Error! Bookmark not defined.
3.8	Party Management	Error! Bookmark not defined.
3.8.1	Administration of Participants	Error! Bookmark not defined.
3.8.1.1	Create a New Participant.....	Error! Bookmark not defined.
3.8.1.2	Edit an Existing Participant	Error! Bookmark not defined.
3.8.1.3	Delete an Existing Participant	Error! Bookmark not defined.
3.9	Reports	Error! Bookmark not defined.
3.9.1	Report Management.....	Error! Bookmark not defined.
3.9.1.1	Create a New Report Configuration..	Error! Bookmark not defined.
3.9.1.2	View Available Reports.....	Error! Bookmark not defined.
3.10	Restriction Types	Error! Bookmark not defined.
3.10.1	Configuration of a New Restriction Type	Error! Bookmark not defined.
3.10.1.1	Create a New Restriction Type	Error! Bookmark not defined.
3.10.1.2	Configure a Restriction Type Rule Set.....	Error! Bookmark not defined.
3.10.2	Assignment of a Restriction Type.....	Error! Bookmark not defined.
3.10.2.1	Assign a Restriction Type to a Party .	Error! Bookmark not defined.
3.10.2.2	Assign a Restriction Type to a Security.....	Error! Bookmark not defined.

3.10.2.3	Assign a Restriction Type to a Securities Account .	Error! Bookmark not defined.
3.10.2.4	Assign a Restriction Type to a T2S Dedicated Cash Account ..	Error! Bookmark not defined.
3.10.2.5	Assign a Restriction Type to an external RTGS Account	Error! Bookmark not defined.
3.11	Revisions	Error! Bookmark not defined.
3.11.1	Monitoring of Revisions	Error! Bookmark not defined.
3.11.1.1	View Revisions	Error! Bookmark not defined.
3.12	Static Data Configuration for the Settlement Process	Error! Bookmark not defined.
3.12.1	Configuration for Intra-CSD Settlement.....	Error! Bookmark not defined.
3.12.1.1	Create a New Participant	Error! Bookmark not defined.
3.12.1.2	Create a New Securities Account	Error! Bookmark not defined.
3.12.1.3	Configure Security CSD Links	Error! Bookmark not defined.
3.12.2	Configuration for Cross-CSD Settlement	Error! Bookmark not defined.
3.12.2.1	Create a New Securities Account	Error! Bookmark not defined.
3.12.2.2	Configure Security CSD Links	Error! Bookmark not defined.
3.12.2.3	Configure CSD Account Links	Error! Bookmark not defined.
3.12.2.4	Configure Eligible Counterpart CSD .	Error! Bookmark not defined.
3.12.3	Configuration for External-CSD Settlement	Error! Bookmark not defined.
3.12.3.1	Configure Security CSD Links	Error! Bookmark not defined.
3.12.3.2	Configure CSD Account Links	Error! Bookmark not defined.
3.13	Account Management	Error! Bookmark not defined.
3.13.1	Administration of Securities Accounts.....	Error! Bookmark not defined.
3.13.1.1	Create a New Securities Account	Error! Bookmark not defined.
3.13.1.2	Edit an Existing Securities Account...	Error! Bookmark not defined.
3.13.1.3	Delete an Existing Securities Account	Error! Bookmark not defined.
3.13.2	Administration of Cash Accounts.....	Error! Bookmark not defined.
3.13.2.1	Create a New External RTGS Account	Error! Bookmark not defined.
3.13.2.2	Create a New T2S Dedicated Cash Account ..	Error! Bookmark not defined.
3.13.2.3	Edit an Existing T2S Dedicated Cash Account	Error! Bookmark not defined.
3.13.2.4	Delete an Existing T2S Dedicated Cash Account ..	Error! Bookmark not defined.
3.13.3	Configuration for a Central Bank	Error! Bookmark not defined.

3.13.3.1	Create a New T2S Dedicated Cash Account ..	Error! Bookmark not defined.
3.13.3.2	Create a New Credit Memorandum Balance...	Error! Bookmark not defined.
3.13.3.3	Set up an Auto-Collateralisation Limit	Error! Bookmark not defined.
3.13.3.4	Create a New Participant.....	Error! Bookmark not defined.
3.13.3.5	Create a New Securities Account	Error! Bookmark not defined.
3.13.3.6	Link a Securities Account to a T2S Dedicated Cash Account for Cash Settlement Purpose.....	Error! Bookmark not defined.
3.13.4	Configuration for Central Bank Collateralisation.....	Error! Bookmark not defined.
3.13.4.1	Create a New Participant.....	Error! Bookmark not defined.
3.13.4.2	Create a New T2S Dedicated Cash Account ..	Error! Bookmark not defined.
3.13.4.3	Create a New Credit Memorandum Balance...	Error! Bookmark not defined.
3.13.4.4	Set up an Auto-Collateralisation Limit	Error! Bookmark not defined.
3.13.4.5	Create a New Securities Account	Error! Bookmark not defined.
3.13.4.6	Link a Securities Account to a T2S Dedicated Cash Account for Cash Settlement Purpose.....	Error! Bookmark not defined.
3.13.5	Configuration for Client Collateralisation.....	Error! Bookmark not defined.
3.13.5.1	Create a New Credit Memorandum Balance...	Error! Bookmark not defined.
3.13.5.2	Set up an Auto-Collateralisation Limit	Error! Bookmark not defined.
3.13.5.3	Create a New Participant.....	Error! Bookmark not defined.
3.13.5.4	Create a New Securities Account	Error! Bookmark not defined.
3.13.5.5	Link a Securities Account to a T2S Dedicated Cash Account for Cash Settlement Purpose.....	Error! Bookmark not defined.
3.14	Securities.....	Error! Bookmark not defined.
3.14.1	Administration of Securities.....	Error! Bookmark not defined.
3.14.1.1	Create a New Security.....	Error! Bookmark not defined.
3.14.1.2	Configure Security CSD Links	Error! Bookmark not defined.
3.14.1.3	Create a New Securities Valuation ...	Error! Bookmark not defined.
3.15	Settlement Instructions.....	Error! Bookmark not defined.
3.15.1	Creation of a New Settlement Instruction.....	Error! Bookmark not defined.
3.15.1.1	Enter a Settlement Instruction.....	Error! Bookmark not defined.
3.15.1.2	Copy a Settlement Instruction.....	Error! Bookmark not defined.
3.15.1.3	Respond to an Allegement Instruction	Error! Bookmark not defined.
3.15.1.4	View Settlement Instruction Details...	Error! Bookmark not defined.

3.15.1.5	View Allegement Settlement Instruction Details	Error! Bookmark not defined.
3.15.2	Creation of a New Amendment Instruction for a Settlement Instruction	Error! Bookmark not defined.
3.15.2.1	Add a Link for a Settlement Instruction	Error! Bookmark not defined.
3.15.2.2	Amend the Partial Settlement Indicator for a Settlement Instruction	Error! Bookmark not defined.
3.15.2.3	Amend the Priority for a Settlement Instruction	Error! Bookmark not defined.
3.15.2.4	Remove a Link for a Settlement Instruction	Error! Bookmark not defined.
3.15.2.5	View Amendment Instruction for a Settlement Instruction Details	Error! Bookmark not defined.
3.15.3	Creation of a New Hold/Release Instruction for a Settlement Instruction	Error! Bookmark not defined.
3.15.3.1	Put a Settlement Instruction on Party Hold	Error! Bookmark not defined.
3.15.3.2	Put a Settlement Instruction on CSD Hold	Error! Bookmark not defined.
3.15.3.3	Release a Settlement Instruction from Party Hold..	Error! Bookmark not defined.
3.15.3.4	Partially Release a Settlement Instruction from Party Hold	Error! Bookmark not defined.
3.15.3.5	Release a Settlement Instruction from CSD Hold ..	Error! Bookmark not defined.
3.15.3.6	Release a Settlement Instruction from CoSD Hold.	Error! Bookmark not defined.
3.15.3.7	Release a Settlement Instruction from CSD Validation Hold	Error! Bookmark not defined.
3.15.3.8	View Hold/Release Instruction Details	Error! Bookmark not defined.
3.15.4	Creation of a New Cancellation Instruction for a Settlement Instruction	Error! Bookmark not defined.
3.15.4.1	Cancel a Settlement Instruction	Error! Bookmark not defined.
3.15.4.2	View Cancellation Instruction for a Settlement Instruction Details	Error! Bookmark not defined.
3.15.4.3	View Alleged Cancellation Instructions	Error! Bookmark not defined.
3.15.5	Monitoring of the Lifecycle of a Settlement Instruction	Error! Bookmark not defined.

3.15.5.1	View Settlement Instruction Status History	Error! Bookmark not defined.
3.15.5.2	View SF1/SF2 timestamps of Settlement Instructions in case of Insolvency situation.....	Error! Bookmark not defined.
3.15.6	View the list of links data preventing settlement of a settlement instruction	Error! Bookmark not defined.
3.15.7	Monitoring of Penalties.....	Error! Bookmark not defined.
3.15.7.1	View the Individual Penalty Details ...	Error! Bookmark not defined.
3.15.7.2	Modification of existing penalties	Error! Bookmark not defined.
3.15.7.3	View List of Penalties.....	Error! Bookmark not defined.
3.15.7.4	View monthly aggregated net amounts of penalties.....	Error! Bookmark not defined.
3.16	Settlement Restrictions	Error! Bookmark not defined.
3.16.1	Creation of a New Settlement Restriction on Securities ...	Error! Bookmark not defined.
3.16.1.1	Enter a Settlement Restriction on Securities...	Error! Bookmark not defined.
3.16.1.2	Copy a Settlement Restriction on Securities ...	Error! Bookmark not defined.
3.16.1.3	View Settlement Restriction on Securities Details..	Error! Bookmark not defined.
3.16.2	Creation of a New Settlement Restriction on Cash.....	Error! Bookmark not defined.
3.16.2.1	Enter a Settlement Restriction on Cash	Error! Bookmark not defined.
3.16.2.2	Copy a Settlement Restriction on Cash	Error! Bookmark not defined.
3.16.2.3	View Settlement Restriction on Cash Details ..	Error! Bookmark not defined.
3.16.3	Creation of a New Amendment Instruction for a Settlement Restriction on Securities	Error! Bookmark not defined.
3.16.3.1	Add a Link for a Settlement Restriction on Securities.....	Error! Bookmark not defined.
3.16.3.2	Amend the Priority for a Settlement Restriction on Securities ..	Error! Bookmark not defined.
3.16.3.3	Remove a Link for a Settlement Restriction on Securities.....	Error! Bookmark not defined.
3.16.3.4	View Amendment Instruction for a Settlement Restriction on Securities Details.....	Error! Bookmark not defined.
3.16.4	Creation of a New Amendment Instruction for a Settlement Restriction on	

	Cash	Error! Bookmark not defined.
3.16.4.1	Add a Link for a Settlement Restriction on Cash....	Error! Bookmark not defined.
3.16.4.2	Amend the Priority for a Settlement Restriction on Cash.....	Error! Bookmark not defined.
3.16.4.3	Remove a Link for a Settlement Restriction on Cash	Error! Bookmark not defined.
3.16.4.4	View Amendment Instruction for a Settlement Restriction on Cash Details	Error! Bookmark not defined.
3.16.5	Creation of a New Cancellation Instruction for a Settlement Restriction on Securities	Error! Bookmark not defined.
3.16.5.1	Cancel a Settlement Restriction on Securities	Error! Bookmark not defined.
3.16.5.2	View Cancellation Instruction for a Settlement Restriction on Securities Details.....	Error! Bookmark not defined.
3.16.6	Creation of a New Cancellation Instruction for a Settlement Restriction on Cash	Error! Bookmark not defined.
3.16.6.1	Cancel a Settlement Restriction on Cash.....	Error! Bookmark not defined.
3.16.6.2	View Cancellation Instruction for a Settlement Restriction on Cash Details	Error! Bookmark not defined.
3.16.7	View the list of links data preventing settlement of a settlement restriction on securities.....	Error! Bookmark not defined.
3.16.8	View the list of links data preventing settlement of a settlement restriction on cash	Error! Bookmark not defined.
3.17	Technical Addresses	Error! Bookmark not defined.
3.17.1	Configuration of a Technical Address	Error! Bookmark not defined.
3.17.1.1	Add a new Technical Address to a Party	Error! Bookmark not defined.
3.17.1.2	Create a New Technical Address Service Link	Error! Bookmark not defined.
3.18	Billing Data	Error! Bookmark not defined.
3.18.1	Monitoring of Billing Data.....	Error! Bookmark not defined.
3.18.1.1	View Billing Data.....	Error! Bookmark not defined.
4	Module Management System Part	57
4.1	General	57
4.2	Screen Reference Part	Error! Bookmark not defined.
4.2.1	Trouble Case – Search/List Screen.....	Error! Bookmark not defined.

4.2.2	Trouble Case - Details Screen.....	Error! Bookmark not defined.
4.2.3	Trouble Case - Export Screen	Error! Bookmark not defined.
4.3	User Instructions Part.....	Error! Bookmark not defined.
4.3.1	Monitoring of a Trouble Case.....	Error! Bookmark not defined.
4.3.1.1	View Trouble Case	Error! Bookmark not defined.
4.3.1.2	Execute a Report.....	Error! Bookmark not defined.
5	Statistical Information Part	57
5.1	General	57
5.2	Screen Reference Part	Error! Bookmark not defined.
5.2.1	Overview	Error! Bookmark not defined.
5.2.2	Cash Management	Error! Bookmark not defined.
5.2.2.1	CPST.00 - T2SDCA: Follow-up by time slot of Cash Postings - Search Screen	Error! Bookmark not defined.
5.2.2.2	CPST.00 - T2SDCA: Follow-up by time slot of Cash Postings – List Screen	Error! Bookmark not defined.
5.2.3	CMB Follow-up.....	Error! Bookmark not defined.
5.2.3.1	CMBR.00 - Journaling of Limit Utilisations of Primary CMB - Search Screen	Error! Bookmark not defined.
5.2.3.2	CMBR.00 - Journaling of Limit Utilisations of Primary CMB – List Screen	Error! Bookmark not defined.
5.2.3.3	CMBR.01 - Journaling of Limit Utilisations of Secondary CMB - Search Screen	Error! Bookmark not defined.
5.2.3.4	CMBR.01 - Journaling of Limit Utilisations of Secondary CMB – List Screen	Error! Bookmark not defined.
5.2.4	Collateralisation Follow-up.....	Error! Bookmark not defined.
5.2.4.1	COLL.00 - T2SDCA: Follow-up by time slot of Settled Collateralisation Instructions - Search Screen	Error! Bookmark not defined.
5.2.4.2	COLL.00 - T2SDCA: Follow-up by time slot of Settled Collateralisation Instructions – List Screen.....	Error! Bookmark not defined.
5.2.4.3	COLL.01 - Securities Accounts: Follow up by time slot of Settled Collateralisation Instructions - Search Screen	Error! Bookmark not defined.
5.2.4.4	COLL.01 - Securities Accounts: Follow-up by time slot of Settled Collateralisation Instructions – List Screen	Error! Bookmark not defined.
5.2.4.5	COLL.02 - T2SDCA: Settled or Cancelled (user, system or manual) Collateralisation Instructions - Search Screen .	Error! Bookmark not defined.
5.2.4.6	COLL.02 - T2SDCA: Settled or Cancelled (user, system or manual)	

	Collateralisation Instructions – List Screen	Error! Bookmark not defined.
5.2.5	Final Business Instructions.....	Error! Bookmark not defined.
5.2.5.1	BSIR.00 - T2SDCA: Finalised Matched Instructions – Search Screen	Error! Bookmark not defined.
5.2.5.2	BSIR.00 - T2SDCA: Finalised Matched Instructions – List Screen	Error! Bookmark not defined.
5.2.5.3	BSIR.01 - Securities Account: Finalised Matched Instructions - Search Screen	Error! Bookmark not defined.
5.2.5.4	BSIR.01 - Securities Account: Finalised Matched Instructions - List Screen	Error! Bookmark not defined.
5.2.5.5	BSIR.02 - T2SDCA: Detailed Finalised Matched Settlement Instructions - Search Screen.....	Error! Bookmark not defined.
5.2.5.6	BSIR.02 - T2SDCA: Detailed Finalised Matched Settlement Instructions – List Screen.....	Error! Bookmark not defined.
5.2.5.7	BSIR.03 - Securities Account: Detailed Finalised Matched Settlement Instructions - Search Screen	Error! Bookmark not defined.
5.2.5.8	BSIR.03 - Securities Account: Detailed Finalised Matched Settlement Instructions – List Screen	Error! Bookmark not defined.
5.2.5.9	BSIR.04 - T2SDCA: Follow-up by time slot of Settlement Activity - Search Screen	Error! Bookmark not defined.
5.2.5.10	BSIR.04 - T2SDCA: Follow-up by time slot of Settlement Activity – List screen.....	Error! Bookmark not defined.
5.2.5.11	BSIR.05 - T2SDCA: Comparison of Settlement activity between two time periods - Search Screen	Error! Bookmark not defined.
5.2.5.12	BSIR.05 - T2SDCA: Comparison of Settlement activity between two time periods – List screen.....	Error! Bookmark not defined.
5.2.6	Instructions Follow-up.....	Error! Bookmark not defined.
5.2.6.1	XREP.00 - T2SDCA: Matched Cancelled Instructions - Search Screen	Error! Bookmark not defined.
5.2.6.2	XREP.00 - T2SDCA: Matched Cancelled Instructions – List Screen	Error! Bookmark not defined.
5.2.6.3	XREP.01 - Securities Account: Matched Cancelled Instructions - Search Screen	Error! Bookmark not defined.
5.2.6.4	XREP.01 - Securities Account: Matched Cancelled Instructions – List Screen	Error! Bookmark not defined.
5.2.6.5	XREP.02 - Finalised Non Matched Cancellations - Search Screen	Error! Bookmark not defined.
5.2.6.6	XREP.02 - Finalised Non Matched Cancellations – List Screen	Error! Bookmark not defined.
5.2.7	Liquidity Transfers	Error! Bookmark not defined.

5.2.7.1	LIQU.00 - Liquidity Transfers - Search Screen	Error! Bookmark not defined.
5.2.7.2	LIQU.00 - Liquidity Transfers – List Screen	Error! Bookmark not defined.
5.2.8	Querying	Error! Bookmark not defined.
5.2.8.1	BSIQ.00 - Individual Settlement detailed Query - Search Screen	Error! Bookmark not defined.
5.2.8.2	BSIQ.00 - Individual Settlement detailed Query - List Screen ..	Error! Bookmark not defined.
5.2.8.3	BSIQ.01 - Multi-criteria search of a set of Settlement Instructions - Search ScreenContext of Usage	Error! Bookmark not defined.
5.2.8.4	BSIQ.01 - Multi-criteria search of a set of Settlement Instructions – List screen.....	Error! Bookmark not defined.
5.2.8.5	BSIQ.02 - Individual Restriction detailed Query - Search Screen	Error! Bookmark not defined.
5.2.8.6	BSIQ.02 - Individual Restriction detailed Query - List Screen ..	Error! Bookmark not defined.
5.2.8.7	BSIQ.03 - Multi-criteria search of a set of Settlement Restrictions - Search Screen	Error! Bookmark not defined.
5.2.8.8	BSIQ.03 - Multi-criteria search of a set of Settlement Restrictions – List Screen	Error! Bookmark not defined.
5.2.8.9	BSIQ.04 - Multi criteria search of a set of Liquidity Transfers - Search Screen	Error! Bookmark not defined.
5.2.8.10	BSIQ.04 - Multi-criteria search of a set of Liquidity Transfers – List Screen	Error! Bookmark not defined.
5.2.8.11	BSIQ.05 - Multi-criteria search of a set of Business Cancellations - Search Screen	Error! Bookmark not defined.
5.2.8.12	BSIQ.05 - Multi-criteria search of a set of Business Cancellations - List Screen	Error! Bookmark not defined.
5.2.8.13	BSIQ.06 - Multi-criteria search of a set of Amendment Instructions - Search Screen	Error! Bookmark not defined.
5.2.8.14	BSIQ.06 - Multi-criteria search of a set of Amendment Instructions - List Screen	Error! Bookmark not defined.
5.2.8.15	BSIQ.07 - Multi-criteria search of a set of Hold and Release Instructions - Search Screen.....	Error! Bookmark not defined.
5.2.8.16	BSIQ.07 - Multi-criteria search of a set of Hold and Release Instructions – List Screen.....	Error! Bookmark not defined.
5.2.9	Realignment Follow-up.....	Error! Bookmark not defined.
5.2.9.1	REAL.00 - Detailed Realignment and Other Technical Instructions - Search Screen	Error! Bookmark not defined.
5.2.9.2	REAL.00 - Detailed Realignment and Other Technical Instructions –	

	List Screen	Error! Bookmark not defined.
5.2.10	Restrictions Management.....	Error! Bookmark not defined.
5.2.10.1	REST.00 - Detailed Cash Restrictions - Search Screen.....	Error! Bookmark not defined.
5.2.10.2	REST.00 - Detailed Cash Restrictions – List Screen.....	Error! Bookmark not defined.
5.2.10.3	REST.01 - Detailed Securities Restrictions - Search Screen ...	Error! Bookmark not defined.
5.2.10.4	REST.01 - Detailed Securities Restrictions – List Screen	Error! Bookmark not defined.
5.2.11	Securities Management	Error! Bookmark not defined.
5.2.11.1	SPST.00 - Securities Account: Follow-up by time schedule of Securities Postings - Search Screen	Error! Bookmark not defined.
5.2.11.2	SPST.00 - Securities Account: Follow-up by time schedule of Securities Postings – List Screen	Error! Bookmark not defined.
ix	58	
6	Index 60	
6.1	Indication of Usage	60
6.1.1	Reader's Guide.....	60
6.1.2	Usage Indication	60
6.2	Itemmap 75	
6.2.1	Reader's Guide.....	75
6.2.2	Securities 80	
6.2.2.1	Securities Account.....	80
6.2.2.2	Settlement 81	
6.2.2.3	Settlement II 82	
6.2.3	Cash 83	
6.2.3.1	Cash Account	83
6.2.3.2	Liquidity 84	
6.2.3.3	Liquidity II 85	
6.2.3.4	Settlement 86	
6.2.4	Services 87	
6.2.4.1	Additional Services	87
6.2.4.2	Additional Services II	88
6.2.4.3	Additional Services III	89
6.2.4.4	Additional Services IV.....	90
6.2.4.5	Additional Services V.....	91
6.2.4.6	Additional Services VI.....	92

6.2.4.7	Communication.....	93
6.2.4.8	Communication II.....	94
6.2.4.9	Communication III.....	95
6.2.5	Static Data	96
6.2.5.1	Parties	96
6.2.5.2	Securities	97
6.2.5.3	Securities Account.....	98
6.2.5.4	T2S Dedicated Cash Account.....	99
6.2.5.5	Scheduling	100
6.2.5.6	Access Rights.....	101
6.2.5.7	Access Rights II.....	102
6.2.5.8	Messages and Reports.....	103
6.2.5.9	Network Configuration	104
6.2.5.10	Market-Specific Configuration.....	105
6.2.5.11	General Configuration Parameters	106
6.2.5.12	General Configuration Parameters II	107
6.2.5.13	Revisions	108
6.2.6	Monitoring	109
6.2.6.1	Monitoring	109
6.3	List of Privileges.....	112
6.3.1	Reader's Guide.....	112
6.3.2	Privilege Classes for GUI Screens.....	112
6.3.3	Privileges for GUI Screens	135
6.3.3.1	Allegation Instruction - Details Screen	135
6.3.3.2	Allegation Instructions - Search/List Screen.....	135
6.3.3.3	Amendment Cash Instruction - Details Screen.....	135
6.3.3.4	Amendment Cash Instruction - New Screen	136
6.3.3.5	Amendment Securities Instruction - Details Screen	136
6.3.3.6	Amendment Securities Instruction - New Screen	136
6.3.3.7	Attribute Domain - Details Screen.....	137
6.3.3.8	Attribute Domain - New/Edit Screen	138
6.3.3.9	Attribute Domain Reference - Details Screen.....	138
6.3.3.10	Attribute Domain Reference - New/Edit Screen	138
6.3.3.11	Attribute Domain References - List Screen	139
6.3.3.12	Attribute Domains - Search/List Screen	139
6.3.3.13	Auto-Collateralisation Eligibility Link - New Screen	140
6.3.3.14	Auto-Collateralisation Eligibility Links - Search/List Screen.....	140
6.3.3.15	Available Report - Current Settlement Day Cash Information (Following Settlement Day Cash Forecast) Report - Details Screen .	140
6.3.3.16	Available Report - Details Screen	141
6.3.3.17	Available Report - Statement of Accounts - Details Screen.....	141

6.3.3.18	Available Report - Statement of Executed Amendment Instructions for Intra-Balance Movements - Details Screen	141
6.3.3.19	Available Report - Statement of Executed Amendment Instructions for Intra-Position Movements and Settlement Instructions - Details Screen	142
6.3.3.20	Available Report - Statement of Executed Cancellation Instructions for Intra-Balance Movements - Details Screen	142
6.3.3.21	Available Report - Statement of Executed Cancellation Instructions for Intra-Position Movements and Settlement Instructions - Details Screen	142
6.3.3.22	Available Report - Statement of Holdings - Details Screen	143
6.3.3.23	Available Report - Statement of Pending Amendment Instructions for Intra-Balance Movements - Details Screen.....	143
6.3.3.24	Available Report - Statement of Pending Amendment Instructions for Intra-Position Movements and Settlement Instructions - Details Screen	143
6.3.3.25	Available Report - Statement of Pending Cancellation Instructions for Intra-Balance Movements - Details Screen.....	144
6.3.3.26	Available Report - Statement of Pending Cancellation Instructions for Intra-Position Movements and Settlement Instructions - Details Screen	144
6.3.3.27	Available Report - Statement of Pending Instructions - Details Screen	144
6.3.3.28	Available Report - Statement of Pending Intra-Balance Movements - Details Screen.....	145
6.3.3.29	Available Report - Statement of Pending Intra-Position Movements - Details Screen.....	145
6.3.3.30	Available Report - Statement of Settled Intra-Balance Movements - Details Screen.....	145
6.3.3.31	Available Report - Statement of Settled Intra-Position Movements - Details Screen.....	146
6.3.3.32	Available Report - Statement of Settlement Allegements - Details Screen	146
6.3.3.33	Available Report - Statement of Static Data - Details Screen.....	146
6.3.3.34	Available Report - Statement of Transactions - Details Screen....	147
6.3.3.35	Available Reports - Search/List Screen.....	147
6.3.3.36	Broadcast - Details Screen	147
6.3.3.37	Broadcast - New Screen	147
6.3.3.38	Broadcasts - Search/List Screen.....	148
6.3.3.39	Cancellation Cash Instruction - Details Screen	148
6.3.3.40	Cancellation Cash Instruction - New Screen.....	148
6.3.3.41	Cancellation Securities Instruction - Details Screen	149

6.3.3.42	Cancellation Securities Instruction - New Screen.....	149
6.3.3.43	Cash Discount Penalty Rate - Search/List Screen	150
6.3.3.44	Cash Forecast - Details Screen	151
6.3.3.45	Cash Forecasts - Search/List Screen	151
6.3.3.46	Cash Restriction Details - Search/List Screen.....	151
6.3.3.47	Certificate Distinguished Name - New Screen	151
6.3.3.48	Certificates Distinguished Names - Search/List Screen	152
6.3.3.49	Close Link – New Screen.....	152
6.3.3.50	Close Links - Search/List Screen.....	152
6.3.3.51	CMB - Details Screen	153
6.3.3.52	CMB - New/Edit Screen.....	153
6.3.3.53	CMBs - Search/List Screen.....	154
6.3.3.54	Collateral Value of a Security - Search/List Screen.....	154
6.3.3.55	Collateral Value per T2S Dedicated Cash Account and Security - Search/List Screen.....	154
6.3.3.56	CoSD Rule - New/Edit Screen	155
6.3.3.57	CoSD Rule Set - New/Edit Screen.....	155
6.3.3.58	CoSD Rule Sets - Search/List Screen.....	156
6.3.3.59	CoSD Rules - List Screen	156
6.3.3.60	Countries - Search/List Screen	156
6.3.3.61	CSD Account Link - New/Edit Screen	157
6.3.3.62	CSD Account Links - Search/List Screen.....	157
6.3.3.63	Cumulative Billing Data - Details Screen.....	157
6.3.3.64	Cumulative Billing Data - Search/List Screen.....	158
6.3.3.65	Currencies - Search/List Screen	158
6.3.3.66	Daily Price - New/Edit Screen.....	158
6.3.3.67	Daily Price - Search/List Screen	159
6.3.3.68	Daily Schedules – Search/List Screen.....	159
6.3.3.69	Data Change - Details Screen	159
6.3.3.70	Data Changes - Search/List Screen.....	160
6.3.3.71	Eligible Counterpart CSD - Details Screen.....	160
6.3.3.72	Eligible Counterpart CSD - New/Edit Screen	161
6.3.3.73	Eligible Counterpart CSDs - Search/List Screen	161
6.3.3.74	Euro Foreign Exchange Reference Rate - New/Edit Screen	162
6.3.3.75	Euro Foreign Exchange Reference Data - Search/List Screen	162
6.3.3.76	Event Type - Details Screen	163
6.3.3.77	Event Types - Search/List Screen.....	163
6.3.3.78	External RTGS Account - Details Screen.....	163
6.3.3.79	External RTGS Account - New/Edit Screen	164
6.3.3.80	External RTGS Accounts - Search/List Screen	164
6.3.3.81	Grant/Revoke Cross-System Entity Object Privilege - Details Screen	

6.3.3.82	Grant/Revoke Cross-System Entity Object Privilege - New/Edit Screen	165
6.3.3.83	Grant/Revoke Object Privilege - Details Screen.....	165
6.3.3.84	Grant/Revoke Object Privilege - New/Edit Screen	166
6.3.3.85	Grant/Revoke Privileges - Search Screen.....	166
6.3.3.86	Grant/Revoke Role - Details Screen	166
6.3.3.87	Grant/Revoke Role - New/Edit Screen.....	166
6.3.3.88	Grant/Revoke System Privilege - Details Screen	167
6.3.3.89	Grant/Revoke System Privilege - New/Edit Screen.....	167
6.3.3.90	Granted Roles - Search/List Screen	167
6.3.3.91	Hold/Release Instruction - Details Screen.....	168
6.3.3.92	Hold/Release Instruction - New Screen	168
6.3.3.93	Immediate Liquidity Transfer Order - New Screen	169
6.3.3.94	Immediate Liquidity Transfer Order- Details Screen.....	170
6.3.3.95	Immediate Liquidity Transfer Orders - Search/List Screen.....	170
6.3.3.96	Inbound File - Details Screen.....	171
6.3.3.97	Inbound Files - Search/List Screen	171
6.3.3.98	Inbound Message - Details Screen	171
6.3.3.99	Inbound Messages - Search/List Screen	172
6.3.3.100	Insolvency procedure Settlement Instructions - Search/List Screen	172
6.3.3.101	Intra-Balance Movement - Details Screen.....	172
6.3.3.102	Intra-Balance Movement - New Screen	172
6.3.3.103	Intra-Balance Movements - Search/List Screen	173
6.3.3.104	Intra-Position Movement - Details Screen.....	173
6.3.3.105	Intra-Position Movement - New Screen.....	174
6.3.3.106	Intra-Position Movements - Search/List Screen	174
6.3.3.107	Itemised Billing Data - Details Screen.....	175
6.3.3.108	Itemised Billing Data - Search/List Screen	175
6.3.3.109	Limit - New/Edit Screen	175
6.3.3.110	Limit Utilisation - Search/List Screen	176
6.3.3.111	Limit Utilisation Journal - Search/List Screen.....	176
6.3.3.112	Limits - Search/List Screen	176
6.3.3.113	Maintenance Cash Instructions – Search/List Screen	177
6.3.3.114	Maintenance Securities Instructions – Search/List Screen.....	178
6.3.3.115	Market-Specific Attribute - Details Screen.....	178
6.3.3.116	Market-Specific Attribute - New/Edit Screen	179
6.3.3.117	Market-Specific Attributes - Search/List Screen	179
6.3.3.118	Message Subscription Rule - New/Edit Screen.....	180
6.3.3.119	Message Subscription Rule Set - Details Screen.....	180
6.3.3.120	Message Subscription Rule Set - New/Edit Screen	181
6.3.3.121	Message Subscription Rule Sets - Search/List Screen	181

6.3.3.122	Message Subscription Rules - List Screen.....	182
6.3.3.123	Network Services - Search/List Screen.....	182
6.3.3.124	Outbound File - Details Screen.....	183
6.3.3.125	Outbound Files - Search/List Screen.....	183
6.3.3.126	Outbound Message - Details Screen.....	184
6.3.3.127	Outbound Messages - Search/List Screen.....	184
6.3.3.128	Outstanding Auto-Collateralisation Credits - Search/List Screen..	185
6.3.3.129	Overall Liquidity - Search/List Screen.....	185
6.3.3.130	Partial Settlement Thresholds - Search/List Screen.....	185
6.3.3.131	Parties - Search/List Screen.....	185
6.3.3.132	Party - Details Screen.....	186
6.3.3.133	Party - New/Edit Screen.....	186
6.3.3.134	Privileges - Search/List Screen.....	187
6.3.3.135	Queued Static Data Change - Details Screen.....	187
6.3.3.136	Queued Static Data Changes - Search/List Screen.....	188
6.3.3.137	Report Configuration - Details Screen.....	188
6.3.3.138	Report Configuration - New/Edit Screen.....	188
6.3.3.139	Report Configurations - Search/List Screen.....	189
6.3.3.140	Resend Communication Screen.....	189
6.3.3.141	Restricted Parties - Search/List Screen.....	190
6.3.3.142	Restriction Type - New/Edit Screen.....	190
6.3.3.143	Restriction Type Rule - Details Screen.....	190
6.3.3.144	Restriction Type Rule - New/Edit Screen.....	191
6.3.3.145	Restriction Type Rule Sets - List Screen.....	191
6.3.3.146	Restriction Types - Search/List Screen.....	192
6.3.3.147	Revisions/Audit Trail - Details Screen.....	192
6.3.3.148	Revisions/Audit Trail - List Screen.....	193
6.3.3.149	Role - New/Edit Screen.....	196
6.3.3.150	Roles - Search/List Screen.....	196
6.3.3.151	Routing - New/Edit Screen.....	196
6.3.3.152	Routings - Search/List Screen.....	197
6.3.3.153	Secured Group - Details Screen.....	197
6.3.3.154	Secured Group - New/Edit Screen.....	197
6.3.3.155	Secured Groups - Search/List Screen.....	198
6.3.3.156	Securities - Search/List Screen.....	198
6.3.3.157	Securities Account - Details Screen.....	198
6.3.3.158	Securities Account - New/Edit Screen.....	199
6.3.3.159	Securities Account Transfer Management - Edit Screen.....	199
6.3.3.160	Securities Accounts - Search/List Screen.....	200
6.3.3.161	Securities Accounts Link - New/Edit Screen.....	200
6.3.3.162	Securities Accounts Links - Search/List Screen.....	200
6.3.3.163	Securities Position - Details Screen.....	201

6.3.3.164	Securities Positions - Search/List Screen	201
6.3.3.165	Securities Postings - Search/List Screen	202
6.3.3.166	Securities Restriction Details - Search/List Screen	202
6.3.3.167	Securities Subject to Cash Penalties - Search/List Screen	202
6.3.3.168	Securities Subject to Cash Penalties - New/Edit Screen	203
6.3.3.169	Securities Valuation - New Screen.....	203
6.3.3.170	Securities Valuations - Search/List Screen	203
6.3.3.171	Security - Details Screen	204
6.3.3.172	Security - New/Edit Screen	204
6.3.3.173	Security CSD Link - Details Screen	204
6.3.3.174	Security CSD Link - New/Edit Screen	205
6.3.3.175	Security CSD Links - Search/List Screen.....	205
6.3.3.176	Security Penalty Rate - Search/List Screen	206
6.3.3.177	Service Item - Details Screen	206
6.3.3.178	Service Items - Search/List Screen.....	206
6.3.3.179	Settlement Instruction - Details Screen	206
6.3.3.180	Settlement Instruction - New Screen.....	207
6.3.3.181	Settlement Instructions – Search/List Screen.....	211
6.3.3.182	SME Growth Market - Search/List Screen	212
6.3.3.183	Standing/Predefined Liquidity Transfer Order - Details Screen	212
6.3.3.184	Standing/Predefined Liquidity Transfer Order - New/Edit Screen.	212
6.3.3.185	Standing/Predefined Liquidity Transfer Order Link Set - Details Screen	213
6.3.3.186	Standing/Predefined Liquidity Transfer Order Link Set - New/Edit Screen	213
6.3.3.187	Standing/Predefined Liquidity Transfer Order Link Sets - Search/List Screen	214
6.3.3.188	Standing/Predefined Liquidity Transfer Orders - Search/List Screen 214	
6.3.3.189	Static Data Revisions - Search/List Screen.....	215
6.3.3.190	Status History - Details Screen	216
6.3.3.191	System Entities - Search/List Screen.....	216
6.3.3.192	T2S BIC Directory Items - Search/List Screen	216
6.3.3.193	T2S Calendar	217
6.3.3.194	T2S DCA Balance - Details Screen	217
6.3.3.195	T2S DCA Balances - Search/List Screen.....	217
6.3.3.196	T2S DCA Postings - Search/List Screen.....	217
6.3.3.197	T2S Dedicated Cash Account - Details Screen.....	218
6.3.3.198	T2S Dedicated Cash Account - New/Edit Screen	218
6.3.3.199	T2S Dedicated Cash Accounts - Search/List Screen	219
6.3.3.200	Technical Addresses Network Services Link - Details Screen	219
6.3.3.201	Technical Addresses Network Services Link - New/Edit Screen ..	220

6.3.3.202	Tolerance Amounts - Search/List Screen.....	220
6.3.3.203	Total Amount of Standing/Predefined Liquidity Transfer Orders - Search/List Screen.....	220
6.3.3.204	Total Collateral Value per T2S Dedicated Cash Account - Search/List Screen	221
6.3.3.205	User - Details Screen.....	221
6.3.3.206	User - New/Edit Screen	221
6.3.3.207	User Access Rights - List Screen.....	222
6.3.3.208	User Access Rights - Search Screen.....	222
6.3.3.209	User Certificate Distinguished Name Link - New Screen	222
6.3.3.210	User Certificate Distinguished Name Links - Search/List Screen .	223
6.3.3.211	Users - Search/List Screen	223
6.3.3.212	Working/Closing Days - Search/List Screen	223
6.3.4	Privilege Classes for LTSI Screens.....	224
6.3.5	Privileges for LTSI Screens	224
6.3.5.1	BSIQ.00 - Individual Settlement detailed Query – List Screen	225
6.3.5.2	BSIQ.00 - Individual Settlement detailed Query – Search Screen	225
6.3.5.3	BSIQ.01 - Multi-criteria search of a set of Settlement Instructions - List Screen	226
6.3.5.4	BSIQ.01 - Multi-criteria search of a set of Settlement Instructions - Search Screen	226
6.3.5.5	BSIQ.02 - Individual Restriction detailed Query – List Screen.....	227
6.3.5.6	BSIQ.02 - Individual Restriction detailed Query – Search Screen	227
6.3.5.7	BSIQ.03 - Multi-criteria search of a set of Settlement Restrictions - List Screen	227
6.3.5.8	BSIQ.03 - Multi-criteria search of a set of Settlement Restrictions - Search Screen	228
6.3.5.9	BSIQ.04 - Multi-criteria search of a set of Liquidity Transfers - List Screen	228
6.3.5.10	BSIQ.04 - Multi-criteria search of a set of Liquidity Transfers - Search Screen	228
6.3.5.11	BSIQ.05 - Multi-criteria search of a set of Business Cancellations - List Screen	229
6.3.5.12	BSIQ.05 - Multi-criteria search of a set of Business Cancellations - Search Screen	229
6.3.5.13	BSIQ.06 - Multi-criteria search of a set of Amendment Instructions – List Screen	230
6.3.5.14	BSIQ.06 - Multi-criteria search of a set of Amendment Instructions - Search Screen	230
6.3.5.15	BSIQ.07 - Multi-criteria search of a set of Hold and Release Instruc- tions - List Screen.....	230
6.3.5.16	BSIQ.07 - Multi-criteria search of a set of Hold and Release Instruc-	

	tions - Search Screen.....	231
6.3.5.17	BSIR.00 - T2SDCA: Finalised matched Instructions – List Screen 231	
6.3.5.18	BSIR.00 - T2SDCA: Finalised matched Instructions – Search Screen 231	
6.3.5.19	BSIR.01 - Securities Account: Finalised matched Instructions - List Screen 232	
6.3.5.20	BSIR.01 - Securities Account: Finalised matched Instructions - Search Screen	232
6.3.5.21	BSIR.02 - T2SDCA: Detailed Finalised matched Settlement Instruc- tions - List Screen.....	232
6.3.5.22	BSIR.02 - T2SDCA: Detailed Finalised matched Settlement Instruc- tions - Search Screen.....	233
6.3.5.23	BSIR.03 - Securities Account: Detailed Finalised matched Settlement Instructions - List Screen.....	233
6.3.5.24	BSIR.03 - Securities Account: Detailed Finalised matched Settlement Instructions - Search Screen	233
6.3.5.25	BSIR.04 - T2SDCA: Follow-up by time slot of Settlement Activity - List Screen	234
6.3.5.26	BSIR.04 - T2SDCA: Follow-up by time slot of Settlement Activity - Search Screen	234
6.3.5.27	BSIR.05 - T2SDCA: Comparison of Settlement activity between two time periods - List Screen.....	234
6.3.5.28	BSIR.05 - T2SDCA: Comparison of Settlement activity between two time periods - Search Screen	235
6.3.5.29	CMBR.00 - Journaling of Limit Utilisations of Primary CMB - Search Screen 235	
6.3.5.30	CMBR.00 - Journaling of Limits Utilisations of Primary CMB - List Screen 235	
6.3.5.31	CMBR.01 - Journaling of Limits Utilisations of Secondary CMB - List Screen 235	
6.3.5.32	CMBR.01 - Journaling of Limits Utilisations of Secondary CMB - Search Screen	236
6.3.5.33	COLL.00 - T2SDCA: Follow-up by time slot of Settled Collateralisa- tion Instructions - List Screen	236
6.3.5.34	COLL.00 - T2SDCA: Follow-up by time slot of Settled Collateralisa- tion Instructions - Search Screen.....	236
6.3.5.35	COLL.01 - Securities Accounts: Follow up by time slot of Settled Col- lateralisation Instructions - Search Screen	236
6.3.5.36	COLL.01 - Securities Accounts: Follow-up by time slot of Settled Col- lateralisation Instructions - List Screen	237
6.3.5.37	COLL.02 - T2SDCA: Settled or Cancelled (automatic or manual) Col-	

	lateralisation Instructions - List Screen	237
6.3.5.38	COLL.02 - T2SDCA: Settled or Cancelled (automatic or manual) Col- lateralisation Instructions - Search Screen	237
6.3.5.39	CPST.00 - T2SDCA: Follow-up by time slot of Cash Postings - List Screen	237
6.3.5.40	CPST.00 - T2SDCA: Follow-up by time slot of Cash Postings - Search Screen	238
6.3.5.41	LIQU.00 - Liquidity Transfers - List Screen	238
6.3.5.42	LIQU.00 - Liquidity Transfers - Search Screen.....	238
6.3.5.43	REAL.00 - Detailed Realignment and Other Technical Instructions - List Screen	238
6.3.5.44	REAL.00 - Detailed Realignment and Other Technical Instructions - Search Screen	239
6.3.5.45	REST.00 - Detailed Cash Restrictions - List Screen	239
6.3.5.46	REST.00 - Detailed Cash Restrictions - Search Screen.....	239
6.3.5.47	REST.01 - Detailed Securities Restrictions - Search Screen	239
6.3.5.48	REST.01 - Detailed Securities Restrictions - List Screen	240
6.3.5.49	SPST.00 - Securities Account: Follow-up by time schedule of Securi- ties Postings - List Screen	240
6.3.5.50	SPST.00 - Securities Account: Follow-up by time schedule of Securi- ties Postings - Search Screen	241
6.3.5.51	XREP.00 - T2SDCA: Matched Cancelled Instructions - List Screen 241	
6.3.5.52	XREP.00 - T2SDCA: Matched Cancelled Instructions - Search Screen	241
6.3.5.53	XREP.01 - Securities Account: Matched Cancelled Instructions - List Screen	241
6.3.5.54	XREP.01 - Securities Account: Matched Cancelled Instructions - Search Screen	242
6.3.5.55	XREP.02 - Finalised Non Matched Cancellations - List Screen ...	242
6.3.5.56	XREP.02 - Finalised Non Matched Cancellations - Search Screen 243	
6.4	List of References for Error Messages	243
6.4.1	Reader's Guide.....	243
6.4.2	References for Error Messages for GUI Screens.....	243
6.4.2.1	Security - New/Edit Screen	243
6.4.2.2	All	244
6.4.2.3	All Screens which allow the initiation of a query.....	244
6.4.2.4	All Screens which allow the initiation of a second user action (4-eyes mode)	244
6.4.2.5	Allegation Instruction - Details Screen	244

6.4.2.6	Allegation Instructions - Search/List Screen.....	244
6.4.2.7	Amendment Cash Instruction - Details Screen.....	244
6.4.2.8	Amendment Cash Instruction - New Screen	244
6.4.2.9	Amendment Securities Instruction - Details Screen	244
6.4.2.10	Amendment Securities Instruction - New Screen	244
6.4.2.11	Attribute Domain - Details Screen.....	244
6.4.2.12	Attribute Domain - New/Edit Screen	245
6.4.2.13	Attribute Domain Reference - Details Screen.....	245
6.4.2.14	Attribute Domain Reference - New/Edit Screen	245
6.4.2.15	Attribute Domain References - List Screen	245
6.4.2.16	Attribute Domains - Search/List Screen	245
6.4.2.17	Auto-Collateralisation Eligibility Link - New Screen	245
6.4.2.18	Auto-Collateralisation Eligibility Links - Search/List Screen.....	245
6.4.2.19	Available Report - Current Settlement Day Cash Information (Following Settlement Day Cash Forecast) Report – Details Screen	245
6.4.2.20	Available Report - Details Screen	245
6.4.2.21	Available Report - Statement of Accounts - Details Screen.....	246
6.4.2.22	Available Report - Statement of Executed Amendment Instructions for Intra-Balance Movements - Details Screen	246
6.4.2.23	Available Report - Statement of Executed Amendment Instructions for Intra-Position Movements and Settlement Instructions - Details Screen	246
6.4.2.24	Available Report - Statement of Executed Cancellation Instructions for Intra-Balance Movements - Details Screen	246
6.4.2.25	Available Report - Statement of Executed Cancellation Instructions for Intra-Position Movements and Settlement Instructions - Details Screen	246
6.4.2.26	Available Report - Statement of Holdings - Details Screen	246
6.4.2.27	Available Report - Statement of Pending Amendment Instructions for Intra-Balance Movements - Details Screen.....	247
6.4.2.28	Available Report - Statement of Pending Amendment Instructions for Intra-Position Movements and Settlement Instructions - Details Screen	247
6.4.2.29	Available Report - Statement of Pending Cancellation Instructions for Intra-Balance Movements - Details Screen.....	247
6.4.2.30	Available Report - Statement of Pending Cancellation Instructions for Intra-Position Movements and Settlement Instructions - Details Screen	247
6.4.2.31	Available Report - Statement of Pending Instructions - Details Screen	247
6.4.2.32	Available Report - Statement of Pending Intra-Balance Movements - Details Screen.....	247

6.4.2.33	Available Report - Statement of Pending Intra-Position Movements - Details Screen.....	248
6.4.2.34	Available Report - Statement of Settled Intra-Balance Movements - Details Screen.....	248
6.4.2.35	Available Report - Statement of Settled Intra-Position Movements - Details Screen.....	248
6.4.2.36	Available Report - Statement of Settlement Allegements - Details Screen	248
6.4.2.37	Available Report - Statement of Static Data - Details Screen.....	248
6.4.2.38	Available Report - Statement of Transactions - Details Screen....	248
6.4.2.39	Available Reports - Search/List Screen.....	248
6.4.2.40	Broadcast - Details Screen	249
6.4.2.41	Broadcast - New Screen	249
6.4.2.42	Broadcasts - Search/List Screen.....	249
6.4.2.43	Cancellation Cash Instruction - Details Screen	249
6.4.2.44	Cancellation Cash Instruction - New Screen.....	249
6.4.2.45	Cancellation Securities Instruction - Details Screen	249
6.4.2.46	Cancellation Securities Instruction - New Screen.....	249
6.4.2.47	Cash Forecast - Details Screen	249
6.4.2.48	Cash Forecasts - Search/List Screen	250
6.4.2.49	Cash Restriction Details - Search/List Screen.....	250
6.4.2.50	Certificate Distinguished Name - New Screen	250
6.4.2.51	Certificates Distinguished Names - Search/List Screen	250
6.4.2.52	Close Link - New Screen	250
6.4.2.53	Close Links - Search/List Screen.....	250
6.4.2.54	CMB - Details Screen	250
6.4.2.55	CMB - New/Edit Screen.....	250
6.4.2.56	CMBs - Search/List Screen.....	250
6.4.2.57	Collateral Value of a Security - Search/List Screen.....	251
6.4.2.58	Collateral Value per T2S Dedicated Cash Account and Security - Search/List Screen.....	251
6.4.2.59	CoSD Rule - New/Edit Screen	251
6.4.2.60	CoSD Rule Set - New/Edit Screen.....	251
6.4.2.61	CoSD Rule Sets - Search/List Screen.....	251
6.4.2.62	CoSD Rules - Search/List Screen.....	251
6.4.2.63	Countries - Search/List Screen	251
6.4.2.64	CSD Account Link - New/Edit Screen	251
6.4.2.65	CSD Account Links - Search/List Screen.....	251
6.4.2.66	Cumulative Billing Data - Details Screen.....	252
6.4.2.67	Cumulative Billing Data - Search/List Screen.....	252
6.4.2.68	Currencies - Search/List Screen	252
6.4.2.69	Daily Price – New/Edit Screen	252

6.4.2.70	Daily Price – Search/List Screen.....	252
6.4.2.71	Daily Schedules – Search/List Screen.....	252
6.4.2.72	Data Change - Details Screen	253
6.4.2.73	Data Changes - Search/List Screen.....	253
6.4.2.74	Eligible Counterpart CSD - Details Screen.....	254
6.4.2.75	Eligible Counterpart CSD - New/Edit Screen	254
6.4.2.76	Eligible Counterpart CSDs - Search/List Screen	254
6.4.2.77	Euro Foreign Exchange Reference Rate - New/Edit Screen	254
6.4.2.78	Euro Foreign Exchange Reference Data - Search/List Screen	254
6.4.2.79	Event Type - Details Screen	254
6.4.2.80	Event Types - Search/List Screen.....	254
6.4.2.81	External RTGS Account - Details Screen.....	254
6.4.2.82	External RTGS Account - New/Edit Screen	254
6.4.2.83	External RTGS Accounts - Search/List Screen	255
6.4.2.84	Grant/Revoke Cross-System Entity Object Privilege - Details Screen 255	
6.4.2.85	Grant/Revoke Cross-System Entity Object Privilege - New/Edit Screen 255	
6.4.2.86	Grant/Revoke Object Privilege - Details Screen.....	255
6.4.2.87	Grant/Revoke Object Privilege - New/Edit Screen	255
6.4.2.88	Grant/Revoke Privileges - Search Screen.....	255
6.4.2.89	Grant/Revoke Role - Details Screen	255
6.4.2.90	Grant/Revoke Role - New/Edit Screen.....	255
6.4.2.91	Grant/Revoke System Privilege - Details Screen	256
6.4.2.92	Grant/Revoke System Privilege - New/Edit Screen.....	256
6.4.2.93	Granted Roles - Search/List Screen	256
6.4.2.94	Hold/Release Instruction - Details Screen.....	256
6.4.2.95	Hold/Release Instruction - New Screen	256
6.4.2.96	Immediate Liquidity Transfer Order - Details Screen.....	256
6.4.2.97	Immediate Liquidity Transfer Order - New Screen	256
6.4.2.98	Immediate Liquidity Transfer Orders - Search/List Screen.....	256
6.4.2.99	Inbound File - Details Screen.....	257
6.4.2.100	Inbound Files - Search/List Screen	257
6.4.2.101	Inbound Message - Details Screen	257
6.4.2.102	Inbound Messages - Search/List Screen	257
6.4.2.103	Insolvency procedure Settlement Instructions - Search/List Screen 257	
6.4.2.104	Intra-Balance Movement - Details Screen.....	257
6.4.2.105	Intra-Balance Movement - New Screen	257
6.4.2.106	Intra-Balance Movements - Search/List Screen	257
6.4.2.107	Intra-Position Movement - Details Screen.....	257
6.4.2.108	Intra-Position Movement - New Screen.....	258

6.4.2.109	Intra-Position Movements - Search/List Screen	258
6.4.2.110	Itemised Billing Data - Details Screen	258
6.4.2.111	Itemised Billing Data - Search/List Screen	258
6.4.2.112	Limit - New/Edit Screen	258
6.4.2.113	Limit Utilisation - Search/List Screen	258
6.4.2.114	Limit Utilisation Journal - Search/List Screen	258
6.4.2.115	Limits - Search/List Screen	258
6.4.2.116	Maintenance Cash Instructions – Search/List Screen	258
6.4.2.117	Maintenance Securities Instructions - Search/List Screen.....	259
6.4.2.118	Market-Specific Attribute - Details Screen.....	259
6.4.2.119	Market-Specific Attribute - New/Edit Screen	259
6.4.2.120	Market-Specific Attributes - Search/List Screen	259
6.4.2.121	Message Subscription Rule - New/Edit Screen.....	259
6.4.2.122	Message Subscription Rule Set - Details Screen.....	259
6.4.2.123	Message Subscription Rule Set - New/Edit Screen	259
6.4.2.124	Message Subscription Rule Sets - Search/List Screen	259
6.4.2.125	Message Subscription Rules - List Screen.....	260
6.4.2.126	Network Services - Search/List Screen.....	260
6.4.2.127	Outbound File - Details Screen	260
6.4.2.128	Outbound Files - Search/List Screen	260
6.4.2.129	Outbound Message - Details Screen	260
6.4.2.130	Outbound Messages - Search/List Screen.....	260
6.4.2.131	Outstanding Auto-Collateralisation Credits - Search/List Screen..	260
6.4.2.132	Overall Liquidity - Search/List Screen	260
6.4.2.133	Partial Settlement Thresholds - Search/List Screen	260
6.4.2.134	Parties - Search/List Screen	261
6.4.2.135	Party - Details Screen.....	261
6.4.2.136	Party - New/Edit Screen	261
6.4.2.137	Penalty - Details Screen	261
6.4.2.138	Penalty - Re-allocation Screen	261
6.4.2.139	Penalty – Removal Screen	261
6.4.2.140	Penalty - Switch Screen.....	261
6.4.2.141	Privileges - Search/List Screen.....	261
6.4.2.142	Queued Static Data Change – Details Screen	261
6.4.2.143	Queued Static Data Changes – Search/List Screen.....	261
6.4.2.144	Report Configuration - Details Screen	262
6.4.2.145	Report Configuration - New/Edit Screen	262
6.4.2.146	Report Configurations - Search/List Screen.....	262
6.4.2.147	Resend Communication Screen	262
6.4.2.148	Restricted Parties - Search/List Screen	262
6.4.2.149	Restriction Type - New/Edit Screen	262
6.4.2.150	Restriction Type Rule - Details Screen	262

6.4.2.151	Restriction Type Rule - New/Edit Screen	262
6.4.2.152	Restriction Type Rule Sets - List Screen.....	262
6.4.2.153	Restriction Types - Search/List Screen.....	262
6.4.2.154	Revisions/Audit Trail - Details Screen.....	263
6.4.2.155	Revisions/Audit Trail - List Screen	263
6.4.2.156	Role - New/Edit Screen	263
6.4.2.157	Roles - Search/List Screen	263
6.4.2.158	Routing - New/Edit Screen	263
6.4.2.159	Routings - Search/List Screen	263
6.4.2.160	Secured Group - Details Screen	263
6.4.2.161	Secured Group - New/Edit Screen.....	263
6.4.2.162	Secured Groups - Search/List Screen.....	263
6.4.2.163	Securities - Search/List Screen.....	263
6.4.2.164	Securities Account - Details Screen.....	264
6.4.2.165	Securities Account - New/Edit Screen	264
6.4.2.166	Securities Account Transfer Management - Edit Screen.....	264
6.4.2.167	Securities Accounts - Search/List Screen	264
6.4.2.168	Securities Accounts Link - New/Edit Screen	264
6.4.2.169	Securities Accounts Links – Search/List Screen	264
6.4.2.170	Securities Position - Details Screen	264
6.4.2.171	Securities Positions - Search/List Screen	264
6.4.2.172	Securities Postings - Search/List Screen	264
6.4.2.173	Securities Restriction Details - Search/List Screen	265
6.4.2.174	Securities Subject to Cash Penalties - New/Edit Screen.....	265
6.4.2.175	Securities Subject to Cash Penalties - Search/List Screen	265
6.4.2.176	Securities Valuation - New Screen.....	265
6.4.2.177	Securities Valuations - Search/List Screen	265
6.4.2.178	Security - Details Screen	265
6.4.2.179	Security CSD Link - Details Screen	265
6.4.2.180	Security CSD Link - New/Edit Screen	265
6.4.2.181	Security CSD Links - Search/List Screen.....	265
6.4.2.182	Service Item - Details Screen	266
6.4.2.183	Service Items - Search/List Screen.....	266
6.4.2.184	Settlement Instruction - Details Screen.....	266
6.4.2.185	Settlement Instruction - New Screen.....	267
6.4.2.186	Settlement Instruction - Search/List Screen	268
6.4.2.187	Standing/Predefined Liquidity Transfer Order - Details Screen....	268
6.4.2.188	Standing/Predefined Liquidity Transfer Order - New/Edit Screen.	268
6.4.2.189	Standing/Predefined Liquidity Transfer Order Link Set - Details Screen	268
6.4.2.190	Standing/Predefined Liquidity Transfer Order Link Set - New/Edit Screen	268

6.4.2.191	Standing/Predefined Liquidity Transfer Order Link Sets - Search/List Screen	268
6.4.2.192	Standing/Predefined Liquidity Transfer Orders - Search/List Screen	268
6.4.2.193	Static Data Revisions - Search/List Screen.....	268
6.4.2.194	Status History - Details Screen	269
6.4.2.195	System Entities - Search/List Screen.....	269
6.4.2.196	T2S BIC Directory Items - Search/List Screen	269
6.4.2.197	T2S Calendar	269
6.4.2.198	T2S DCA Balance - Details Screen	269
6.4.2.199	T2S DCA Balances - Search/List Screen.....	269
6.4.2.200	T2S DCA Postings - Search/List Screen.....	269
6.4.2.201	T2S Dedicated Cash Account - Details Screen.....	269
6.4.2.202	T2S Dedicated Cash Account - New/Edit Screen	269
6.4.2.203	T2S Dedicated Cash Accounts - Search/List Screen	270
6.4.2.204	Technical Addresses Network Services Link - Details Screen	270
6.4.2.205	Technical Addresses Network Services Link - New/Edit Screen ..	270
6.4.2.206	Tolerance Amounts - Search/List Screen.....	270
6.4.2.207	Total Amount of Standing/Predefined Liquidity Transfer Orders - Search/List Screen	270
6.4.2.208	Total Collateral Value per T2S Dedicated Cash Account - Search/List Screen	270
6.4.2.209	User - Details Screen.....	270
6.4.2.210	User - New/Edit Screen	270
6.4.2.211	User Access Rights - List Screen.....	271
6.4.2.212	User Access Rights - Search Screen.....	271
6.4.2.213	User Certificate Distinguished Name Link - New Screen	271
6.4.2.214	User Certificate Distinguished Name Links - Search/List Screen .	271
6.4.2.215	Users - Search/List Screen	271
6.4.2.216	Working/Closing Days - Search/List Screen	271
6.4.2.217	Dedicated Cash Account – New/Edit Screen	271
6.4.3	References for Error Messages for TMS Screens.....	271
6.4.3.1	Trouble Case - Search/List Screen	271
6.4.3.2	Trouble Case - Details Screen.....	271
6.4.3.3	Trouble Case - Export Screen	272
6.4.4	References for Error Messages for LTSI Screens.....	272
6.4.4.1	BSIQ.00 - Individual Settlement detailed Query – List Screen	272
6.4.4.2	BSIQ.00 - Individual Settlement detailed Query – Search Screen	272
6.4.4.3	BSIQ.01 - Multi-criteria search of a set of Settlement Instructions - List Screen	272
6.4.4.4	BSIQ.01 - Multi-criteria search of a set of Settlement Instructions -	

	Search Screen	272
6.4.4.5	BSIQ.02 - Individual Restriction detailed Query – List Screen.....	272
6.4.4.6	BSIQ.02 - Individual Restriction detailed Query – Search Screen	272
6.4.4.7	BSIQ.03 - Multi-criteria search of a set of Settlement Restrictions - List Screen	273
6.4.4.8	BSIQ.03 - Multi-criteria search of a set of Settlement Restrictions - Search Screen	273
6.4.4.9	BSIQ.04 - Multi-criteria search of a set of Liquidity Transfers - List Screen	273
6.4.4.10	BSIQ.04 - Multi-criteria search of a set of Liquidity Transfers - Search Screen	273
6.4.4.11	BSIQ.05 - Multi-criteria search of a set of Business Cancellations - List Screen	273
6.4.4.12	BSIQ.05 - Multi-criteria search of a set of Business Cancellations - Search Screen	273
6.4.4.13	BSIQ.06 - Multi-criteria search of a set of Amendment Instructions - List Screen	273
6.4.4.14	BSIQ.06 - Multi-criteria search of a set of Amendment Instructions - Search Screen	274
6.4.4.15	BSIQ.07 - Multi-criteria search of a set of Hold and Release Instruc- tions - List Screen.....	274
6.4.4.16	BSIQ.07 - Multi-criteria search of a set of Hold and Release Instruc- tions - Search Screen.....	274
6.4.4.17	BSIR.00 - T2SDCA: Finalised Matched Instructions – List Screen	274
6.4.4.18	BSIR.00 - T2SDCA: Finalised Matched Instructions – Search Screen	274
6.4.4.19	BSIR.01 - Securities Account: Finalised Matched Instructions - List Screen	274
6.4.4.20	BSIR.01 - Securities Account: Finalised Matched Instructions - Search Screen	274
6.4.4.21	BSIR.02 - T2SDCA: Detailed Finalised Matched Settlement Instruc- tions - List Screen.....	274
6.4.4.22	BSIR.02 - T2SDCA: Detailed Finalised Matched Settlement Instruc- tions - Search Screen.....	275
6.4.4.23	BSIR.03 - Securities Account: Detailed Finalised Matched Settlement Instructions - List Screen	275
6.4.4.24	BSIR.03 - Securities Account: Detailed Finalised Matched Settlement Instructions - Search Screen	275
6.4.4.25	BSIR.04 - T2SDCA: Follow-up by time slot of Settlement Activity - List Screen	275
6.4.4.26	BSIR.04 - T2SDCA: Follow-up by time slot of Settlement Activity -	

	Search Screen	275
6.4.4.27	BSIR.05 - T2SDCA: Comparison of Settlement activity between two time periods - List Screen.....	275
6.4.4.28	BSIR.05 - T2SDCA: Comparison of Settlement activity between two time periods - Search Screen	275
6.4.4.29	CMBR.00 - Journaling of Limits Utilisations of Primary CMB - List Screen	276
6.4.4.30	CMBR.00 - Journaling of Limits Utilisations of Primary CMB - Search Screen	276
6.4.4.31	CMBR.01 - Journaling of Limits Utilisations of Secondary CMB - List Screen	276
6.4.4.32	CMBR.01 - Journaling of Limits Utilisations of Secondary CMB - Search Screen	276
6.4.4.33	COLL.00 - T2SDCA: Follow-up by time slot of Settled Collateralisation Instructions - List Screen	276
6.4.4.34	COLL.00 - T2SDCA: Follow-up by time slot of Settled Collateralisation Instructions - Search Screen.....	276
6.4.4.35	COLL.01 - Securities Accounts: Follow up by time slot of Settled Collateralisation Instructions - Search Screen	276
6.4.4.36	COLL.01 - Securities Accounts: Follow-up by time slot of Settled Collateralisation Instructions - List Screen	277
6.4.4.37	COLL.02 - T2SDCA: Settled or Cancelled (automatic or manual) Collateralisation Instructions - List Screen	277
6.4.4.38	COLL.02 - T2SDCA: Settled or Cancelled (automatic or manual) Collateralisation Instructions - Search Screen	277
6.4.4.39	CPST.00 - T2SDCA: Follow-up by time slot of Cash Postings - List Screen	277
6.4.4.40	CPST.00 - T2SDCA: Follow-up by time slot of Cash Postings - Search Screen	277
6.4.4.41	LIQU.00 - Liquidity Transfers - List Screen	277
6.4.4.42	LIQU.00 - Liquidity Transfers - Search Screen.....	277
6.4.4.43	REAL.00 - Detailed Realignment and Other Technical Instructions - List Screen	278
6.4.4.44	REAL.00 - Detailed Realignment and Other Technical Instructions - Search Screen	278
6.4.4.45	REST.00 - Detailed Cash Restrictions - List Screen	278
6.4.4.46	REST.00 - Detailed Cash Restrictions - Search Screen.....	278
6.4.4.47	REST.01 - Detailed Securities Restrictions - Search Screen	278
6.4.4.48	REST.01 - Detailed Securities Restrictions - List Screen	278
6.4.4.49	SPST.00 - Securities Account: Follow-up by time schedule of Securities Postings – List Screen	278
6.4.4.50	SPST.00 - Securities Account: Follow-up by time schedule of Securi-	

	ties Postings - Search Screen	279
6.4.4.51	XREP.00 - T2SDCA: Matched Cancelled Instructions - List Screen 279	
6.4.4.52	XREP.00 - T2SDCA: Matched Cancelled Instructions - Search Screen 279	
6.4.4.53	XREP.01 - Securities Account: Matched Cancelled Instructions - List Screen 279	
6.4.4.54	XREP.01 - Securities Account: Matched Cancelled Instructions - Search Screen	279
6.4.4.55	XREP.02 - Finalised Non Matched Cancellations - List Screen ...	279
6.4.4.56	XREP.02 - Finalised Non Matched Cancellations - Search Screen 279	

Terms and Abbreviations

The terms and abbreviations used in the User Handbook, but not included in the T2S glossary are shown in the table below. You find terms with their description and the abbreviations, both in an alphabetical order.

1 Introduction

2 Screen Reference Part

2.1 General

2.2 Securities

2.3 Cash

2.4 Services

2.4.1 Additional Services

2.4.1.1 Available Reports - Search/List Screen

2.4.1.2 Available Reports - Search/List Screen

2.4.1.3 Available Report - Details Screen

2.4.1.4 Available Report - Current Settlement Day Cash Information (Following Settlement Day Cash Forecast) Report - Details Screen

2.4.1.5 Available Report - Statement of Accounts - Details Screen

2.4.1.6 Available Report - Statement of Executed Amendment Instructions for Intra-Balance Movements - Details Screen

2.4.1.7 Available Report - Statement of Executed Amendment Instructions for Intra-Position Movements and Settlement Instructions - Details Screen

2.4.1.8 Available Report - Statement of Executed Cancellation Instructions for Intra-Balance Movements - Details Screen

2.4.1.9 Available Report - Statement of Executed Cancellation Instructions for Intra-Position Movements and Settlement Instructions - Details Screen

2.4.1.10 Available Report - Statement of Holdings - Details Screen

2.4.1.11 Available Report - Statement of Pending Amendment Instructions for Intra-Balance Movements - Details Screen

2.4.1.12 Available Report - Statement of Pending Amendment Instructions for Intra-Position Movements and Settlement Instructions - Details Screen

2.4.1.13 Available Report - Statement of Pending Cancellation Instructions for Intra-Balance Movements - Details Screen

2.4.1.14 Available Report - Statement of Pending Cancellation Instructions for Intra-Position Movements and Settlement Instructions - Details Screen

2.4.1.15 Available Report - Statement of Pending Instructions - Details Screen

2.4.1.16 Available Report - Statement of Pending Intra-Balance Movements - Details Screen

2.4.1.17 Available Report - Statement of Pending Intra-Position Movements - Details Screen

2.4.1.18 Available Report - Statement of Settled Intra-Balance Movements - Details Screen

2.4.1.19 Available Report - Statement of Settled Intra-Position Movements - Details Screen

2.4.1.20 Available Report - Statement of Settlement Allegements - Details Screen

2.4.1.21 Available Report - Statement of Static Data - Details Screen

2.4.1.22 Available Report - Statement of Transactions - Details Screen

2.4.1.23 Available Report – Daily Penalty List – Details Screen

2.4.1.24 Available Report – List of Modified Penalties - Details Screen

2.4.1.25 Available Report – Monthly Aggregated Amounts – Details Screen

2.4.1.26 Cumulative Billing Data - Search/List Screen

2.4.1.27 Cumulative Billing Data - Details Screen

~~2.4.1.28 Daily Schedules - Search/List Screen~~

Context of Usage

~~This screen contains a number of search fields. By inputting the relevant data, you can search for daily schedule data. The search results will be displayed in a list, which is sorted by the values of the 'Default Schedule Time' column in ascending order (default setting). After selecting an entry, you can proceed further by clicking on the buttons below.~~

~~A daily schedule can only be created, edited and forced to complete by the T2S operator.~~

~~There is no usage restriction for this screen.~~

Screen Access Privileges

~~| [Services >> Additional Services >> Settlement Day](#)~~

~~To use this screen, you need the following privileges [[▶ 159](#)]:~~

~~| T2S diary query~~

~~| Current status of the T2S settlement day~~

References

User Instructions Part

~~This screen is not part of a business scenario.~~

Business Functionality Document

~~This screen corresponds to the following business functions:~~

- | ~~Query T2S schedule of settlement day (T2S.GUI.SDSE.SCH.0010)~~
- | ~~Display T2S schedule of settlement day (T2S.GUI.SDSE.SCH.0020)~~

Screenshot

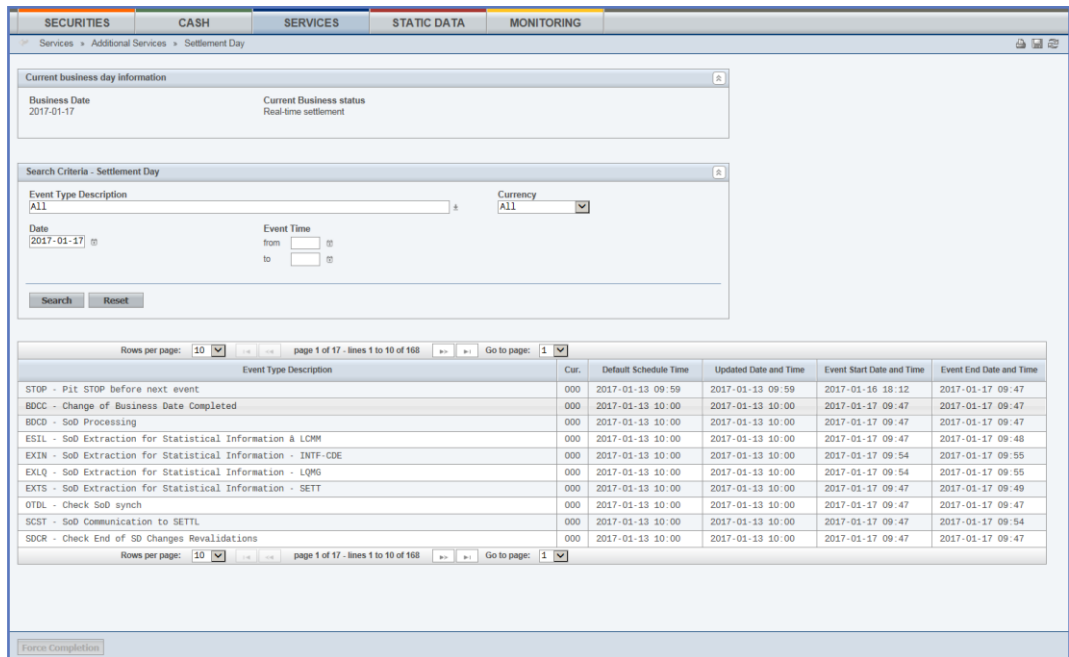

Illustration 1: Daily schedules — search/list screen

Field Description

Current business day information	
Business Date	Shows the date of the business day. Displayed format is: YYYY-MM-DD
Current Business status	Shows the current T2S business status from the possible values: <ul style="list-style-type: none"> SOD period First night-time settlement cycle Last night-time settlement cycle Maintenance window Real-time settlement period Real-time settlement closure period EOD period

Daily Schedule— Search Criteria	
Event Type Description	Select the description of the event type from the drop-down menu. The default value is 'All'. References for error messages [▶-252]: OSAC003 OSAC006
Currency	Select the currency of the event type from the drop-down menu. The default value is 'all'.
Date	Enter the business date of the event or use the calendar icon. The default value is the current business date. Required format is: YYYY-MM-DD Reference for error message [▶-252]: QMPC016
Event Time –from	Enter the lower bound of the search range for the event time. Required format is: hh:mm
Event Time –to	Enter the upper bound of the search range for the event time. Required format is: hh:mm
Daily Schedule— List	
Event Type Description	Shows the description of the event type from the drop-down menu. References for error messages [▶-252]: OSAC003 OSAC006
Currency	Shows the currency of the event type.
Default Schedule Time	Shows the default schedule time. Displayed format is: YYYY-MM-DD hh:mm

Daily Schedule - List	
Update Date and Time	Shows the possible updated schedule time. Displayed format is: YYYY-MM-DD hh:mm
Event Start Date and Time	Shows the start time of the event. Displayed format is: YYYY-MM-DD hh:mm
Event End Date and Time	Shows the end time of the event. Displayed format is: YYYY-MM-DD hh:mm

Buttons

Buttons	
Search	<p>This function enables you to start a search according to the criteria entered. The results are displayed in a list on the same screen.</p> <p>Next screen:</p> <ul style="list-style-type: none"> <i>Daily schedules - search/list screen</i> <p>References for error messages [▶-252]:</p> <ul style="list-style-type: none"> OSAC003 OSAC005 OSAC006 QMPC016
Reset	<p>This function enables you to set default search criteria and blanks out all optional criteria.</p> <p>Next screen:</p> <ul style="list-style-type: none"> <i>Daily schedules - search/list screen</i>

2.4.1.29 Data Changes - Search/List Screen

2.4.1.30 Data Change - Details Screen

2.4.1.31 Itemised Billing Data - Search/List Screen

2.4.1.32 Itemised Billing Data - Details Screen

2.4.1.33 Queued Static Data Changes - Search/List Screen

2.4.1.34 Queued Static Data Change - Details Screen

~~2.4.1.35 T2S Calendar Screen~~

Context of Usage

~~This screen contains a number of search fields. By inputting the relevant data, you can search for the operative calendar entry of the T2S system. The results are displayed in a list on the same screen with days highlighted in different colours depending on whether they are opening or closing days for T2S. There is no usage restriction for this screen.~~

Screen Access

~~| [Services >> Additional Services >> T2S Calendar](#)~~
~~| [Monitoring >> Monitoring >> T2S Calendar](#)~~

Privileges

~~To use this screen, you need the following privilege [▶-217]:~~
~~| [T2S calendar query](#)~~

References

~~**User Instructions Part**~~

~~This screen is not part of a business scenario.~~

~~**Business Functionality Document**~~

~~This screen corresponds to the following business functions:~~

~~| [Query closing day calendar \(T2S.GUI.SDSE.CLD.0010\)](#)~~
~~| [Display closing day calendar \(T2S.GUI.SDSE.CLD.0020\)](#)~~

Screenshot

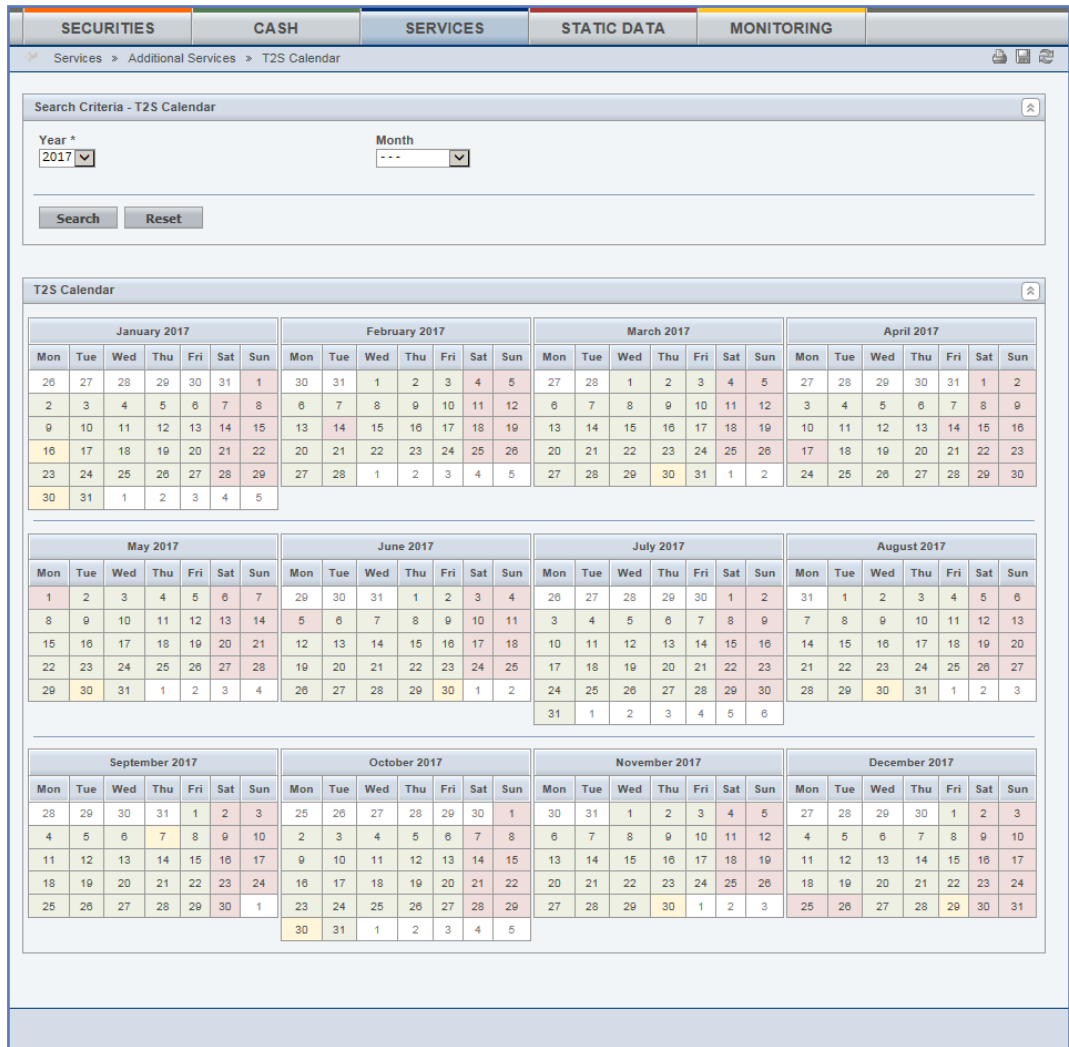

Illustration 2: T2S calendar screen

Field Description

Search Criteria - T2S Calendar	
<u>Year*</u>	Select the year you want to display from the possible values: <ul style="list-style-type: none"> <u>Previous year</u> <u>Current year (default value)</u> <u>Following year</u>
<u>Month</u>	Select the month you want to display from the possible values: <ul style="list-style-type: none"> <u>blank (default value)</u> <u>January</u> <u>February</u> <u>March</u>

<u>Search Criteria – T2S Calendar</u>	
	<ul style="list-style-type: none"> <u>April</u> <u>May</u> <u>June</u> <u>July</u> <u>August</u> <u>September</u> <u>October</u> <u>November</u> <u>December</u>
<u>T2S Calendar</u>	
<u>Month Name</u>	<u>Shows the name of the month.</u>
<u>Day</u>	<u>Shows the days of the month.</u>
<u>Description</u>	<p><u>Shows the opening and closing days or the days with exceptions for specific currencies. The days are marked with colours depending on their content:</u></p> <ul style="list-style-type: none"> <u>Opening days are marked green</u> <u>Closing days are marked red</u> <u>Currency exceptions are marked yellow</u> <p><u>Further information is available via ‘mouse-over’, i.e. the list of currency exceptions for a specific day and the closure reasons.</u></p>
<u>Currency</u>	<u>Shows the currencies which are not available for cash settlement in T2S on the selected day.</u>
<u>Closure Reason</u>	<p><u>Shows the reason why T2S is closed on the selected day from the possible values:</u></p> <ul style="list-style-type: none"> <u>Allowed downtime window</u> <u>Banking holiday</u> <u>Recovery</u> <u>System maintenance</u>

Buttons

<u>Search</u>	<u>This function enables you to start a search according to the criteria entered. The results are displayed in a list on the same screen.</u> <u>Next screen:</u> <u>T2S calendar screen</u>
<u>Reset</u>	<u>This function enables you to set default search criteria and blanks out all optional criteria.</u> <u>Next screen:</u> <u>T2S calendar screen</u>

2.4.1.36 User Access Rights - Search Screen

2.4.1.37 User Access Rights - List Screen

2.4.2 Communication

2.5 Static Data

2.6 Monitoring

2.6.1 Monitoring

2.6.1.1 Securities Positions - Search/List Screen

See *Securities Positions – Search/List Screen* [▶ **Error! Bookmark not defined.**].

2.6.1.2 Securities Position - Details Screen

See *Securities Positions – Details Screen* [▶ **Error! Bookmark not defined.**].

~~2.6.1.3 T2S Calendar Screen~~

~~See *T2S Calendar Screen* [▶ 47].~~

2.6.1.4 T2S DCA Balances - Search/List Screen

See *T2S DCA Balances – Search/List Screen* [**Error! Bookmark not defined.**].

2.6.1.5 T2S DCA Balance - Details Screen

See *T2S DCA Balance – Details Screen* [**Error! Bookmark not defined.**].

2.7 Business Day Management

2.7.1 Settlement Day

2.7.1.1 Settlement Day - Search/List Screen

Context of Usage

This screen enables the user to display a list of Schedule Events of the Current Day Schedule of the specific service matching the entered criteria. The screen allows seeing the Scheduled Events of more than one service at the same time. When returning the list of Scheduled Events, the Service Operator is allowed to see the processes of a selected event, to edit or to force the completion of a selected Scheduled Event or of all Events in the same Chain of the selected Event.

When entering, the screen shows the status of the current business day for each Service.

Screen Access

|*Business Day Management >> Settlement Day >> Settlement Day >> Search*

Privileges

To use this screen, the following Privileges are needed []:

|T2S diary query

|Current status of the T2S settlement day

Screenshot

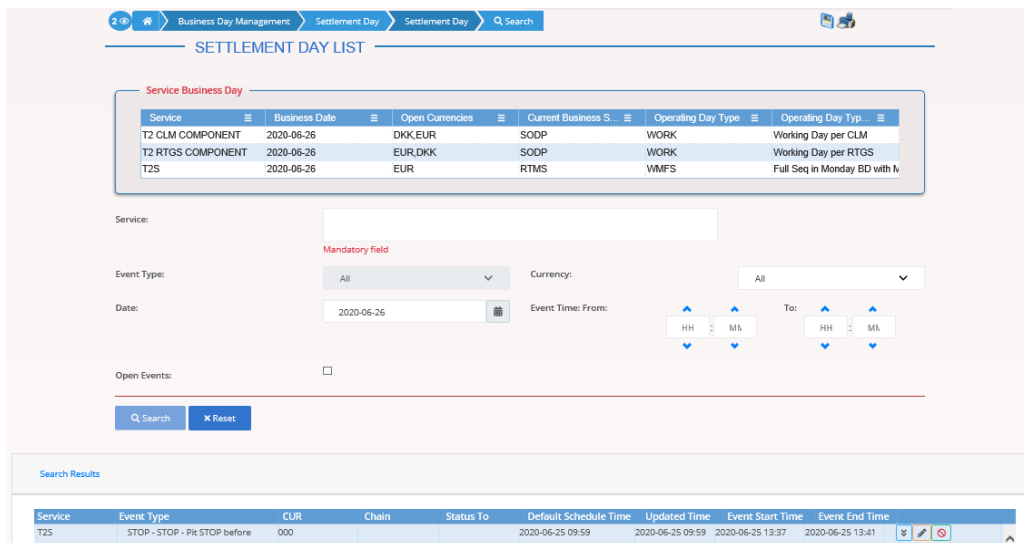

Illustration 12: Settlement Day – search/list screen

Fields Description

Service Business Day	
Service	Shows the description of the Business Day related service.
Business date	Shows the date of the Service business day.
Open currencies	Shows the currencies open for settlement.
Current Business Status	Shows the current Service business status.

Settlement Day – Search Criteria	
Service	Select the list of services the user can see. It must be possible to select one or more Services. This field is mandatory.
Event Type	It contains the list of event descriptions of the selected service(s) defined in the system plus the item “All”. References for error messages [} XXX]: OSAC003 OSAC006
Currency	Select a currency, “All currencies” or “No currencies”.
Date	Enter or select the date of the Events to be searched. Required format is: Date.

Event time: from	Enter the event time as lower bound of the search. Required format is: Time.
Event time: to	Enter the event time as upper bound of the search. Required format is: Time.
Settlement Day – List	
Service	Shows the service of the returned item.
Event Type	Shows the event type description of the returned item.
Currency	Shows the currency code, if any, for which the returned item is configured.
Planning Rule	Shows the planning rule of the related event.
Event Chain	Shows the chain associated to the returned item.
Status to	Shows the new status of the service at the moment the returned item is triggered.
Default Schedule Time	Shows the default schedule time of the returned item.
Updated Time	Shows the possible updated time of the returned item.
Event Start Time	Shows the start time of the returned item.
Event End Time	Shows the end time of the returned item.

Buttons

Buttons	
Search	This function enables the user to start a search according to the filled in criteria. References for error messages [} XXX]: <ul style="list-style-type: none"> OSAC003 OSAC005 OSAC006
Reset	This function enables the user to set default search criteria and blanks out all optional criteria.

2.7.2 Calendar

2.7.2.1 Calendar - Details Screen

Context of Usage

The screen enables the user to consult the operative calendars of Target Services, specifying opening and closing days.

The system shows days, highlighted in a different colour, when the general rule has exception for specific currencies and permits the user to look at these exceptions. Week-ends are always closing days.

Default opening and closing days are defined by the system. Exception to the standard opening and closing days are defined by the Closing Days function.

Screen Access

|Business Day Management >> Calendar >> Calendar

Privileges

To use this screen, the following Privileges are needed []:

|T2S calendar query

Screenshot

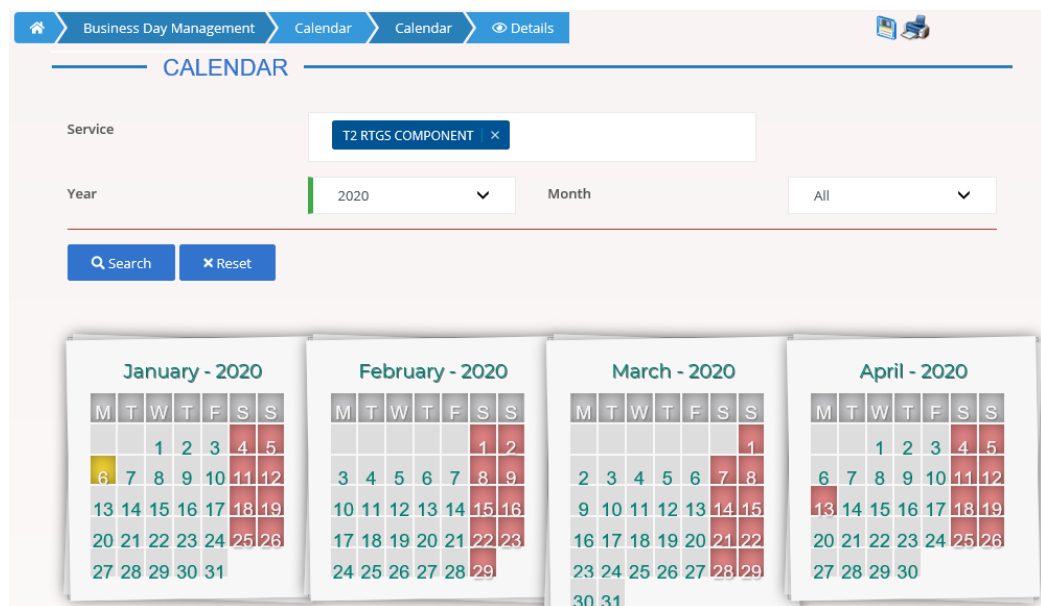

Illustration 13: Calendar – details screen

Fields Description

Calendar – Search Criteria	
Service	Select the Calendar related Service.
Year	Select the year to display from the possible values: <ul style="list-style-type: none"> Previous year Current year (default value) Following year
Month	Select the month to display from the possible values: <ul style="list-style-type: none"> All (default value) January February March April May June July August September October November December

Calendar	
Month Name	Shows the name of the month and the referenced year.
Day	Shows the days of the month.
Description	Shows the opening and closing days or the days with exceptions for specific currencies. The days are marked with colours depending on their content: <ul style="list-style-type: none"> Opening days are marked green Closing days are marked red Currency exceptions are marked yellow Further information is available via 'mouse-over', i.e. the list of currency exceptions for a specific day and the closure reasons.

Currency	Shows the currencies which are not available for cash settlement for the Services on the selected day.
Closure Reason	Shows the reason why a service is closed on the selected day.

Buttons

Search	This function enables the user to start a search according to the filled in criteria.
Reset	This function enables the user to set default search criteria and blanks out all optional criteria.

- 3 User Instructions Part
- 4 Trouble Management System Part
- 5 Statistical Information Part

Index

4

4-eyes mode 67

B

Business object 54

Buttons 60

 Button bar 52

 First 66

 Information panel 51

 Last 66

 Next 66

 Previous 66

 T2S logo 51

C

Characters

 SWIFT-x character set 57

 UTF-8 character set 57

Context of usage 1699

E

Error message 68

F

Field description 1699

Field types

 Check boxes 57

 Input fields 55

 Input-sensitive fields 55

 Radio buttons 56

 Select boxes 55

 Select fields 55

Frame 52, 1700

G

Graphical user interface 42

Graphical User Interface

 Content area 51

 Header 51

 Menu bar 49

 Page layout 42

 Screen layout 50

 Structure 49

I

Icons 60

 Add row 65

 Alert 70

 Auto-complete select box 65

 Back 52, 61

 Calendar 63

 Cancel changes 64

 Collapse 62

 Copy row 63

 Delete row 64

 Export 52, 62

 Magnifier 65

 Pencil 63

 Print 52, 61

 Refresh 52, 62

 Sort 66

 Submit changes 64

Information signs

 Example sign 43

 Notice sign 43

O

Online help 74

P

Privileges 1699

S

Screen reference part 45

Screen types

 Details screen 54

 Enter screen 54

 Search/List screen 53

 Welcome screen 53

Screenshot 44, 1699

Sub-frame 52, 1700

Success message 69

T

T2S system user 48

U

UHB methodology	42
UHB structure	45
User administration	
Registration	73
User instructions part	46

V

Validation	
Back-end validation	67
Confirmation prompt	67
Cross-field validation	67
Field validation	67
Front-end validation	67

W

Wildcard	59
----------	----

6 Annex

6.1 Indication of Usage

6.1.1 Reader's Guide

Reader's Guide

This part of the annex is divided into screens and business scenarios, both in alphabetical order. For each screen description and business scenario, you can find an indication of the primary user (CB / CSD). This indication is not binding.

6.1.2 Usage Indication

Screens

Screen	Usage Indication (CSD/CB)
Allegation Instruction - Details Screen [▶ Error! Bookmark not defined.]	CSD
Allegation Instructions - Search/List Screen [▶ Error! Bookmark not defined.]	CSD
Amendment Cash Instruction - Details Screen [▶ Error! Bookmark not defined.]	CB
Amendment Cash Instruction - New Screen [▶ Error! Bookmark not defined.]	CB
Amendment Securities Instruction - Details Screen [▶ Error! Bookmark not defined.]	CSD
Amendment Securities Instruction - New Screen [▶ Error! Bookmark not defined.]	CSD
Attribute Domain - Details Screen [▶ Error! Bookmark not defined.]	CSD/CB
Attribute Domain - New/Edit Screen [▶ Error! Bookmark not defined.]	CSD/CB
Attribute Domain Reference - Details Screen [▶ Error! Bookmark not defined.]	CSD/CB
Attribute Domain Reference - New/Edit Screen [▶ Error! Bookmark not defined.]	CSD/CB
Attribute Domain References - List Screen [▶ Error! Bookmark not defined.]	CSD/CB

Screen	Usage Indication (CSD/CB)
Attribute Domains - Search/List Screen [▶ Error! Bookmark not defined.]	CSD/CB
Auto-Collateralisation Eligibility Link - New Screen [▶ Error! Bookmark not defined.]	CB
Auto-Collateralisation Eligibility Links - Search/List Screen [▶ Error! Bookmark not defined.]	CB
Available Report - Current Settlement Day Cash Information (Following Settlement Day Cash Forecast) Report - Details Screen [▶ Error! Bookmark not defined.]	CB
Available Report - Details Screen [Error! Bookmark not defined.]	CSD/CB
Available Report - Statement of Accounts - Details Screen [▶ Error! Bookmark not defined.]	CB
Available Report - Statement of Executed Amendment Instructions for Intra-Balance Movements - Details Screen [▶ Error! Bookmark not defined.]	CB
Available Report - Statement of Executed Amendment Instructions for Intra-Position Movements and Settlement Instructions - Details Screen [▶ Error! Bookmark not defined.]	CSD
Available Report - Statement of Executed Cancellation Instructions for Intra-Balance Movements - Details Screen [▶ Error! Bookmark not defined.]	CB
Available Report - Statement of Executed Cancellation Instructions for Intra-Position Movements and Settlement Instructions - Details Screen [▶ Error! Bookmark not defined.]	CSD
Available Report - Statement of Holdings - Details Screen [▶ Error! Bookmark not defined.]	CSD
Available Report - Statement of Pending Amendment Instructions for Intra-Balance Movements - Details Screen [▶ Error! Bookmark not defined.]	CB
Available Report - Statement of Pending Amend-	CSD

Screen	Usage Indication (CSD/CB)
ment Instructions for Intra-Position Movements and Settlement Instructions - Details Screen [▶ Error! Bookmark not defined.]	
Available Report - Statement of Pending Cancellation Instructions for Intra-Balance Movements - Details Screen [▶ Error! Bookmark not defined.]	CB
Available Report - Statement of Pending Cancellation Instructions for Intra-Position Movements and Settlement Instructions - Details Screen [▶ Error! Bookmark not defined.]	CSD
Available Report - Statement of Pending Instructions - Details Screen [▶ Error! Bookmark not defined.]	CSD
Available Report - Statement of Pending Intra-Balance Movements - Details Screen [▶ Error! Bookmark not defined.]	CB
Available Report - Statement of Pending Intra-Position Movements - Details Screen [▶ Error! Bookmark not defined.]	CSD
Available Report - Statement of Settled Intra-Balance Movements - Details Screen [▶ Error! Bookmark not defined.]	CB
Available Report - Statement of Settled Intra-Position Movements - Details Screen [▶ Error! Bookmark not defined.]	CSD
Available Report - Statement of Settlement Allegements - Details Screen [▶ Error! Bookmark not defined.]	CSD
Available Report - Statement of Static Data - Details Screen [▶ Error! Bookmark not defined.]	CSD/CB
Available Report - Statement of Transactions - Details Screen [▶ Error! Bookmark not defined.]	CSD
Available Reports - Search/List Screen [▶ 41]	CSD/CB
Broadcast - Details Screen [▶ Error! Bookmark not	CSD/CB

Screen	Usage Indication (CSD/CB)
defined.]	
Broadcast - New Screen [▶ Error! Bookmark not defined.]	CSD/CB
Broadcasts - Search/List Screen [▶ 50]	CSD/CB
Calendar – Details Screen [▶ XXX]	CSD/CB
Cancellation Cash Instruction - Details Screen [▶ Error! Bookmark not defined.]	CB
Cancellation Cash Instruction - New Screen [▶ Error! Bookmark not defined.]	CB
Cancellation Securities Instruction - Details Screen [▶ Error! Bookmark not defined.]	CSD
Cancellation Securities Instruction - New Screen [▶ Error! Bookmark not defined.]	CSD
Cash Forecast - Details Screen [▶ Error! Bookmark not defined.]	CB
Cash Forecasts - Search/List Screen [▶ Error! Bookmark not defined.]	CB
Cash Restriction Details - Search/List Screen [▶ Error! Bookmark not defined.]	CB
Certificate Distinguished Name - New Screen [▶ Error! Bookmark not defined.]	CSD/CB
Certificate Distinguished Names - Search/List Screen [▶ Error! Bookmark not defined.]	CSD/CB
Close Link - New Screen [▶ Error! Bookmark not defined.]	CB
Close Links - Search/List Screen [▶ Error! Bookmark not defined.]	CSD/CB
Collateral Value of a Security - Search/List Screen [▶ Error! Bookmark not defined.]	CSD/CB
Collateral Value per T2S Dedicated Cash Account and Security - Search/List Screen [▶ Error! Bookmark not defined.]	CSD/CB

Screen	Usage Indication (CSD/CB)
CoSD Rule - New/Edit Screen [▶ Error! Bookmark not defined.]	CSD
CoSD Rule Set – New/Edit Screen [▶ Error! Bookmark not defined.]	CSD
CoSD Rule Sets - Search/List Screen [▶ Error! Bookmark not defined.]	CSD
CoSD Rules – Search/List Screen [▶ Error! Bookmark not defined.]	CSD
Countries - Search/List Screen [▶ Error! Bookmark not defined.]	CSD/CB
CMB - Details Screen [▶ Error! Bookmark not defined.]	CB
CMB - New/Edit Screen [▶ Error! Bookmark not defined.]	CB
CMBs - Search/List Screen [▶ Error! Bookmark not defined.]	CB
CSD Account Link - New/Edit Screen [▶ Error! Bookmark not defined.]	CSD
CSD Account Links - Search/List Screen [▶ Error! Bookmark not defined.]	CSD
Cumulative Billing Data - Details Screen [▶ Error! Bookmark not defined.]	CSD/CB
Cumulative Billing Data - Search/List Screen [▶ Error! Bookmark not defined.]	CSD/CB
Currencies - Search/List Screen [▶ Error! Bookmark not defined.]	CSD/CB
Daily Schedules – Search/List Screen [▶ 43]	CSD/CB
Data Change - Details Screen [▶ 47]	CSD/CB
Data Changes - Search/List Screen [▶ 47]	CSD/CB
Eligible Counterpart CSD - Details Screen [▶ Error! Bookmark not defined.]	CSD

Screen	Usage Indication (CSD/CB)
Eligible Counterpart CSD - New/Edit Screen [▶ Error! Bookmark not defined.]	CSD
Eligible Counterpart CSDs - Search/List Screen [▶ Error! Bookmark not defined.]	CSD
Event Type - Details Screen [▶ Error! Bookmark not defined.]	CSD/CB
Event Types - Search/List Screen [▶ Error! Bookmark not defined.]	CSD/CB
External RTGS Account - Details Screen [▶ Error! Bookmark not defined.]	CB
External RTGS Account - New/Edit Screen [▶ Error! Bookmark not defined.]	CB
External RTGS Accounts - Search/List Screen [▶ Error! Bookmark not defined.]	CB
Grant/Revoke Cross-System Entity Object Privilege – Details Screen [▶ Error! Bookmark not defined.]	CSD/CB
Grant/Revoke Cross-System Entity Object Privilege – New/Edit Screen [▶ Error! Bookmark not defined.]	CSD/CB
Grant/Revoke Object Privilege - Details Screen [▶ Error! Bookmark not defined.]	CSD/CB
Grant/Revoke Object Privilege - New/Edit Screen [▶ Error! Bookmark not defined.]	CSD/CB
Grant/Revoke Privileges - Search Screen [▶ Error! Bookmark not defined.]	CSD/CB
Grant/Revoke Role - Details Screen [▶ Error! Bookmark not defined.]	CSD/CB
Grant/Revoke Role - New/Edit Screen [▶ Error! Bookmark not defined.]	CSD/CB
Grant/Revoke System Privilege - Details Screen [▶ Error! Bookmark not defined.]	CSD/CB
Grant/Revoke System Privilege - New/Edit Screen	CSD/CB

Screen	Usage Indication (CSD/CB)
[▶ Error! Bookmark not defined.]	
Granted Roles - Search/List Screen [▶ Error! Bookmark not defined.]	CSD/CB
Hold/Release Instruction - Details Screen [▶ Error! Bookmark not defined.]	CSD
Hold/Release Instruction - New Screen [▶ Error! Bookmark not defined.]	CSD
Immediate Liquidity Transfer - Details Screen [▶ Error! Bookmark not defined.]	CB
Immediate Liquidity Transfer - New Screen [▶ Error! Bookmark not defined.]	CB
Immediate Liquidity Transfer - Search/List Screen [▶ Error! Bookmark not defined.]	CB
Inbound File - Details Screen [▶ Error! Bookmark not defined.]	CSD/CB
Inbound Files - Search/List Screen [▶ Error! Bookmark not defined.]	CSD/CB
Inbound Message - Details Screen [▶ Error! Bookmark not defined.]	CSD/CB
Inbound Messages - Search/List Screen [▶ Error! Bookmark not defined.]	CSD/CB
Insolvency procedure Settlement Instructions – Search/List Screen [▶ Error! Bookmark not defined.]	CSD
Intra-Balance Movement - Details Screen [▶ Error! Bookmark not defined.]	CB
Intra-Balance Movement - New Screen [▶ Error! Bookmark not defined.]	CB
Intra-Balance Movements - Search/List Screen [▶ Error! Bookmark not defined.]	CB
Intra-Position Movement - Details Screen [▶ Error! Bookmark not defined.]	CSD

Screen	Usage Indication (CSD/CB)
Intra-Position Movement - New Screen [▶ Error! Bookmark not defined.]	CSD
Intra-Position Movements - Search/List Screen [▶ Error! Bookmark not defined.]	CSD
Itemised Billing Data - Details Screen [▶ 47]	CSD/CB
Itemised Billing Data - Search/List Screen [▶ 47]	CSD/CB
Limit - New/Edit Screen [Error! Bookmark not defined.]	CB
Limit Utilisation - Search/List Screen [▶ Error! Bookmark not defined.]	CSD/CB
Limit Utilisation Journal - Search/List Screen [▶ Error! Bookmark not defined.]	CSD/CB
Limits - Search/List Screen [▶ Error! Bookmark not defined.]	CB
Maintenance Cash Instructions - Search/List Screen [▶ Error! Bookmark not defined.]	CB
Maintenance Securities Instructions - Search/List Screen [▶ Error! Bookmark not defined.]	CSD
Market-Specific Attribute - Details Screen [▶ Error! Bookmark not defined.]	CSD/CB
Market-Specific Attribute - New/Edit Screen [▶ Error! Bookmark not defined.]	CSD/CB
Market-Specific Attributes - Search/List Screen [▶ Error! Bookmark not defined.]	CSD/CB
Message Subscription Rule - New/Edit Screen [▶ Error! Bookmark not defined.]	CSD/CB
Message Subscription Rule Set - Details Screen [▶ Error! Bookmark not defined.]	CSD/CB
Message Subscription Rule Set - New/Edit Screen [▶ Error! Bookmark not defined.]	CSD/CB
Message Subscription Rule Sets - Search/List Screen [▶ Error! Bookmark not defined.]	CSD/CB

Screen	Usage Indication (CSD/CB)
Message Subscription Rules - List Screen [▶ Error! Bookmark not defined.]	CSD/CB
Network Services - Search/List Screen [▶ Error! Bookmark not defined.]	CSD/CB
Outbound File - Details Screen [▶ Error! Bookmark not defined.]	CSD/CB
Outbound Files - Search/List Screen [▶ Error! Bookmark not defined.]	CSD/CB
Outbound Message - Details Screen [▶ Error! Bookmark not defined.]	CSD/CB
Outbound Messages - Search/List Screen [▶ Error! Bookmark not defined.]	CSD/CB
Outstanding Auto-Collateralisation Credits - Search/List Screen [▶ Error! Bookmark not defined.]	CSD/CB
Overall Liquidity - Search/List Screen [▶ Error! Bookmark not defined.]	CB
Partial Settlement Thresholds - Search/List Screen [▶ Error! Bookmark not defined.]	CSD/CB
Parties - Search/List Screen [▶ Error! Bookmark not defined.]	CSD/CB
Party - Details Screen [▶ Error! Bookmark not defined.]	CSD/CB
Party - New/Edit Screen [▶ Error! Bookmark not defined.]	CSD/CB
Privileges - Search/List Screen [▶ Error! Bookmark not defined.]	CSD/CB
Queued Static Data Changes – Search/List Screen [▶ 47]	CSD/CD
Queued Static Data Change – Details Screen [▶ 47]	CSD/CD
Report Configuration - Details Screen [▶ Error! Bookmark not defined.]	CSD/CB

Screen	Usage Indication (CSD/CB)
Report Configuration - New/Edit Screen [▶ Error! Bookmark not defined.]	CSD/CB
Report Configurations - Search/List Screen [▶ Error! Bookmark not defined.]	CSD/CB
Resend Communication Screen [▶ Error! Bookmark not defined.]	CSD/CB
Restricted Parties - Search/List Screen [▶ Error! Bookmark not defined.]	CSD/CB
Restriction Type - New/Edit Screen [▶ Error! Bookmark not defined.]	CSD/CB
Restriction Type Rule - Details Screen [▶ Error! Bookmark not defined.]	CSD/CB
Restriction Type Rule - New/Edit Screen [▶ Error! Bookmark not defined.]	CSD/CB
Restriction Type Rule Sets - List Screen [▶ Error! Bookmark not defined.]	CSD/CB
Restriction Types - Search/List Screen [▶ Error! Bookmark not defined.]	CSD/CB
Revisions/Audit Trail - Details Screen [▶ Error! Bookmark not defined.]	CSD/CB
Revisions/Audit Trail - List Screen [▶ Error! Bookmark not defined.]	CSD/CB
Role - New/Edit Screen [▶ Error! Bookmark not defined.]	CSD/CB
Roles - Search/List Screen [▶ Error! Bookmark not defined.]	CSD/CB
Routing - New/Edit Screen [▶ Error! Bookmark not defined.]	CSD/CB
Routings - Search/List Screen [▶ Error! Bookmark not defined.]	CSD/CB
Secured Group - Details Screen [▶ Error! Bookmark not defined.]	CSD/CB

Screen	Usage Indication (CSD/CB)
Secured Group - New/Edit Screen [▶ Error! Bookmark not defined.]	CSD/CB
Secured Groups - Search/List Screen [▶ Error! Bookmark not defined.]	CSD/CB
Securities - Search/List Screen [▶ Error! Bookmark not defined.]	CSD/CB
Securities Account - Details Screen [▶ Error! Bookmark not defined.]	CSD
Securities Account - New/Edit Screen [▶ Error! Bookmark not defined.]	CSD
Securities Account Transfer Management - Edit Screen [▶ Error! Bookmark not defined.]	CSD
Securities Accounts - Search/List Screen [▶ Error! Bookmark not defined.]	CSD
Securities Accounts Link - New/Edit Screen [▶ Error! Bookmark not defined.]	CSD
Securities Accounts Links - Search/List Screen [▶ Error! Bookmark not defined.]	CSD/CB
Securities Position - Details Screen [▶ Error! Bookmark not defined.]	CSD
Securities Positions - Search/List Screen [▶ Error! Bookmark not defined.]	CSD
Securities Postings - Search/List Screen [▶ Error! Bookmark not defined.]	CSD
Securities Restriction Details - Search/List Screen [▶ Error! Bookmark not defined.]	CSD
Securities Valuation - New Screen [▶ Error! Bookmark not defined.]	CB
Securities Valuations - Search/List Screen [▶ Error! Bookmark not defined.]	CB
Security – Details Screen [▶ Error! Bookmark not defined.]	CSD/CB

Screen	Usage Indication (CSD/CB)
Security – New/Edit Screen [▶ Error! Bookmark not defined.]	CSD
Security CSD Link – Details Screen [▶ Error! Bookmark not defined.]	CSD
Security CSD Link – New/Edit Screen [▶ Error! Bookmark not defined.]	CSD
Security CSD Links – Search/List Screen [▶ Error! Bookmark not defined.]	CSD
Service Item – Details Screen [▶ Error! Bookmark not defined.]	CSD/CB
Service Items – Search/List Screen [▶ Error! Bookmark not defined.]	CSD/CB
Settlement Days – Search/List screen [▶ XXX]	CSD/CB
Settlement Instruction – Details Screen [▶ Error! Bookmark not defined.]	CSD
Settlement Instruction – New Screen [▶ Error! Bookmark not defined.]	CSD
Settlement Instructions – Search/List Screen [▶ Error! Bookmark not defined.]	CSD
Standing/Predefined Liquidity Transfer Order – Details Screen [▶ Error! Bookmark not defined.]	CB
Standing/Predefined Liquidity Transfer Order – New/Edit Screen [▶ Error! Bookmark not defined.]	CB
Standing/Predefined Liquidity Transfer Order Link Set – Details Screen [▶ Error! Bookmark not defined.]	CB
Standing/Predefined Liquidity Transfer Order Link Set – New/Edit Screen [▶ Error! Bookmark not defined.]	CB
Standing/Predefined Liquidity Transfer Order Link Sets – Search/List Screen [▶ Error! Bookmark not defined.]	CB

Screen	Usage Indication (CSD/CB)
Standing/Predefined Liquidity Transfer Orders – Search/List Screen [▶ Error! Bookmark not defined.]	CB
Static Data Revisions – Search/List Screen [Error! Bookmark not defined.]	CSD/CB
Status History – Details Screen [▶ Error! Bookmark not defined.]	CSD/CB
System Entities – Search/List Screen [▶ Error! Bookmark not defined.]	CSD/CB
T2S BIC Directory Items - Search/List Screen [▶ Error! Bookmark not defined.]	CSD/CB
T2S Calendar Screen [▶ 47]	CSD/CB
T2S DCA Balance - Details Screen [▶ Error! Bookmark not defined.]	CB
T2S DCA Balances - Search/List Screen [▶ Error! Bookmark not defined.]	CB
T2S DCA Postings - Search/List Screen [▶ Error! Bookmark not defined.]	CB
T2S Dedicated Cash Account - Details Screen [▶ Error! Bookmark not defined.]	CB
T2S Dedicated Cash Account - New/Edit Screen [▶ Error! Bookmark not defined.]	CB
T2S Dedicated Cash Accounts - Search/List Screen [▶ Error! Bookmark not defined.]	CB
Technical Addresses Network Services Link - Details Screen [▶ Error! Bookmark not defined.]	CSD/CB
Technical Addresses Network Services Link - New/Edit Screen [▶ Error! Bookmark not defined.]	CSD/CB
Tolerance Amounts - Search/List Screen [▶ Error! Bookmark not defined.]	CSD/CB
Total Amount of Standing/Predefined Liquidity Transfer Orders - Search/List Screen [▶ Error!	CB

Screen	Usage Indication (CSD/CB)
Bookmark not defined.]	
Total collateral value per T2S dedicated cash account - Search/List Screen [▶ Error! Bookmark not defined.]	CSD/CB
User - Details Screen [▶ Error! Bookmark not defined.]	CSD/CB
User - New/Edit Screen [▶ Error! Bookmark not defined.]	CSD/CB
User Access Rights – List Screen [▶ 50]	CSD/CB
User Access Rights – Search Screen [▶ 50]	CSD/CB
User Certificate Distinguished Name Link - New Screen [▶ Error! Bookmark not defined.]	CSD/CB
User Certificate Distinguished Name Links - Search/List Screen [▶ Error! Bookmark not defined.]	CSD/CB
Users - Search/List Screen [▶ Error! Bookmark not defined.]	CSD/CB
Working/Closing Days - Search/List Screen [▶ Error! Bookmark not defined.]	CSD/CB

Business Scenarios

Business Scenario	Usage Indication (CSD/CB)
Add a Link for a Settlement Instruction [▶ Error! Bookmark not defined.]	CSD
Add a Link for a Settlement Restriction on Cash [▶ Error! Bookmark not defined.]	CB
Add a Link for a Settlement Restriction on Securities [▶ Error! Bookmark not defined.]	CSD
Add a new Technical Address to a Party [▶ Error! Bookmark not defined.]	CSD/CB
Amend the Partial Settlement Indicator for a Settlement Instruction [▶ Error! Bookmark not defined.]	CSD

Business Scenario	Usage Indication (CSD/CB)
Amend the Priority for a Settlement Instruction [▶ Error! Bookmark not defined.]	CSD
Amend the Priority for a Settlement Restriction on Cash [▶ Error! Bookmark not defined.]	CB
Amend the Priority for a Settlement Restriction on Securities [▶ Error! Bookmark not defined.]	CSD
Approve an Action in 4-Eyes Mode [▶ Error! Bookmark not defined.]	CSD/CB
Assign a Market-Specific Attribute Value to a Party [▶ Error! Bookmark not defined.]	CSD/CB
Assign a Market-Specific Attribute Value to a Securities Account [▶ Error! Bookmark not defined.]	CSD
Assign a Market-Specific Attribute Value to a Security [▶ Error! Bookmark not defined.]	CSD
Assign a Restriction Type to a Party [▶ Error! Bookmark not defined.]	CSD/CB
Assign a Restriction Type to a Securities Account [▶ Error! Bookmark not defined.]	CSD
Assign a Restriction Type to a Security [▶ Error! Bookmark not defined.]	CSD
Assign a Restriction Type to a T2S Dedicated Cash Account [▶ Error! Bookmark not defined.]	CB
Assign a Restriction Type to an external RTGS Account [▶ Error! Bookmark not defined.]	CB
Assign a Role to a Party [▶ Error! Bookmark not defined.]	CSD/CB
Assign a Role to a User [▶ Error! Bookmark not defined.]	CSD/CB
Assign a Secured Object to a Secured Group [▶ Error! Bookmark not defined.]	CSD/CB
Cancel a Settlement Instruction [▶ Error! Bookmark not defined.]	CSD

Business Scenario	Usage Indication (CSD/CB)
Cancel a Settlement Restriction on Cash [Error! Bookmark not defined.]	CB
Cancel a Settlement Restriction on Securities [Error! Bookmark not defined.]	CSD
Change the Limit of a Payment Bank [Error! Bookmark not defined.]	CB
Configure a Restriction Type Rule Set [Error! Bookmark not defined.]	CSD/CB
Configure CSD Account Links [Error! Bookmark not defined.]	CSD
Configure Eligible Counterparty CSD [Error! Bookmark not defined.]	CSD
Configure Security CSD Links [Error! Bookmark not defined.]	CSD
Copy a Settlement Instruction [Error! Bookmark not defined.]	CSD
Copy a Settlement Restriction on Cash [Error! Bookmark not defined.]	CB
Copy a Settlement Restriction on Securities [Error! Bookmark not defined.]	CSD
Copy an Immediate Liquidity Transfer [Error! Bookmark not defined.]	CSD/CB
Create a new Attribute Domain [Error! Bookmark not defined.]	CSD/CB
Create a new Broadcast [Error! Bookmark not defined.]	CSD/CB
Create a new CoSD Rule Set [Error! Bookmark not defined.]	CSD
Create a new Credit Memorandum Balance [Error! Bookmark not defined.]	CB
Create a new external RTGS Account [Error! Bookmark not defined.]	CB

Business Scenario	Usage Indication (CSD/CB)
Create a new Immediate Liquidity Transfer [▶ Error! Bookmark not defined.]	CSD/CB
Create a new Liquidity Transfer Order Link Set [▶ Error! Bookmark not defined.]	CB
Create a new Market-Specific Attribute [▶ Error! Bookmark not defined.]	CSD/CB
Create a new Message Subscription Rule Set [▶ Error! Bookmark not defined.]	CSD/CB
Create a new Participant [Error! Bookmark not defined.]	CSD/CB
Create a new Report Configuration [▶ Error! Bookmark not defined.]	CSD/CB
Create a new Restriction Type [▶ Error! Bookmark not defined.]	CSD/CB
Create a new Role [▶ Error! Bookmark not defined.]	CSD/CB
Create a new Secured Group [▶ Error! Bookmark not defined.]	CSD/CB
Create a new Securities Account [▶ Error! Bookmark not defined.]	CSD
Create a new Securities Valuation [▶ Error! Bookmark not defined.]	CB
Create a new Security [▶ Error! Bookmark not defined.]	CSD
Create a new Standing/Predefined Liquidity Transfer Order [▶ Error! Bookmark not defined.]	CB
Create a new T2S Dedicated Cash Account [▶ Error! Bookmark not defined.]	CB
Create a new Technical Address Service Link [▶ Error! Bookmark not defined.]	CSD/CB
Create a new User [▶ Error! Bookmark not defined.]	CSD/CB

Business Scenario	Usage Indication (CSD/CB)
Create a new User Certificate Distinguished Name [▶ Error! Bookmark not defined.]	CSD/CB
Create a new User Certificate Distinguished Name Link [▶ Error! Bookmark not defined.]	CSD/CB
Delete an existing Participant [▶ Error! Bookmark not defined.]	CSD/CB
Delete an existing Securities Account [▶ Error! Bookmark not defined.]	CSD
Delete an existing T2S Dedicated Cash Account [▶ Error! Bookmark not defined.]	CB
Edit an existing Participant	CSD/CB
Edit an existing Securities Account [▶ Error! Bookmark not defined.]	CSD
Edit an existing T2S Dedicated Cash Account [▶ Error! Bookmark not defined.]	CB
Enter a Settlement Instruction [▶ Error! Bookmark not defined.]	CSD
Enter a Settlement Restriction on Cash [▶ Error! Bookmark not defined.]	CB
Enter a Settlement Restriction on Securities [▶ Error! Bookmark not defined.]	CSD
Grant a Privilege to a Party [▶ Error! Bookmark not defined.]	CSD/CB
Grant a Privilege to a User [▶ Error! Bookmark not defined.]	CSD/CB
Grant System and Object Privileges to a Role [▶ Error! Bookmark not defined.]	CSD/CB
Initiate an Action in 4-Eyes Mode [▶ Error! Bookmark not defined.]	CSD/CB
Link a Securities Account to a T2S Dedicated Cash Account for Cash Settlement Purpose [▶ Error! Bookmark not defined.]	CSD

Business Scenario	Usage Indication (CSD/CB)
Put a Settlement Instruction on CSD Hold [▶ Error! Bookmark not defined.]	CSD
Put a Settlement Instruction on Party Hold [▶ Error! Bookmark not defined.]	CSD
Reimburse an Outstanding Intraday Credit [▶ Error! Bookmark not defined.]	CSD
Release a Settlement Instruction from CoSD Hold [▶ Error! Bookmark not defined.]	CSD
Release a Settlement Instruction from CSD Hold [▶ Error! Bookmark not defined.]	CSD
Release a Settlement Instruction from CSD Validation Hold [▶ Error! Bookmark not defined.]	CSD
Release a Settlement Instruction from Party Hold [▶ Error! Bookmark not defined.]	CSD
Remove a Link for a Settlement Instruction [▶ Error! Bookmark not defined.]	CSD
Remove a Link for a Settlement Restriction on Cash [▶ Error! Bookmark not defined.]	CB
Remove a Link for a Settlement Restriction on Securities [▶ Error! Bookmark not defined.]	CSD
Resend Communication [▶ Error! Bookmark not defined.]	CSD/CB
Respond to an Allegement Instruction [▶ Error! Bookmark not defined.]	CSD
Set up an Auto-Collateralisation Limit [▶ Error! Bookmark not defined.]	CB
View a Broadcast [▶ Error! Bookmark not defined.]	CSD/CB
View Alleged Cancellation Instructions [▶ Error! Bookmark not defined.]	CSD
View Allegement Settlement Instruction Details [▶ Error! Bookmark not defined.]	CSD

Business Scenario	Usage Indication (CSD/CB)
View Amendment Instruction for a Settlement Instruction Details [▶ Error! Bookmark not defined.]	CSD
View Amendment Instruction for a Settlement Restriction on Cash Details [▶ Error! Bookmark not defined.]	CB
View Amendment Instruction for a Settlement Restriction on Securities Details [▶ Error! Bookmark not defined.]	CSD
View Available Reports [▶ Error! Bookmark not defined.]	CSD/CB
View Cancellation Instruction for a Settlement Instruction Details [▶ Error! Bookmark not defined.]	CSD
View Cancellation Instruction for a Settlement Restriction on Cash Details [▶ Error! Bookmark not defined.]	CB
View Cancellation Instruction for a Settlement Restriction on Securities Details [▶ Error! Bookmark not defined.]	CSD
View Cash Balances Details and Related Postings [▶ Error! Bookmark not defined.]	CB
View Cash Balances Details and Related Restrictions [▶ Error! Bookmark not defined.]	CB
View Current Securities Positions and Related Postings [▶ Error! Bookmark not defined.]	CSD
View Current Securities Positions and Related Restrictions [▶ Error! Bookmark not defined.]	CSD
View Historic Securities Positions for a Specific Date [▶ Error! Bookmark not defined.]	CSD
View Historic Securities Positions for a Specific Period [▶ Error! Bookmark not defined.]	CSD
View Hold/Release Instruction Details [▶ Error! Bookmark not defined.]	CSD
View Immediate Liquidity Transfer Details [▶ Error!	CSD/CB

Business Scenario	Usage Indication (CSD/CB)
Bookmark not defined.]	
View Inbound Communication [▶ Error! Bookmark not defined.]	CSD/CB
View Outbound Communication [▶ Error! Bookmark not defined.]	CSD/CB
View Overall Liquidity [▶ Error! Bookmark not defined.]	CSD/CB
View Privilege Details [▶ Error! Bookmark not defined.]	CSD/CB
View Revisions [▶ Error! Bookmark not defined.]	CSD/CB
View Settlement Instruction Details [▶ Error! Bookmark not defined.]	CSD
View Settlement Instruction Status History [▶ Error! Bookmark not defined.]	CSD
View Settlement Restriction on Cash Details [▶ Error! Bookmark not defined.]	CB
View Settlement Restriction on Securities Details [▶ Error! Bookmark not defined.]	CSD
View SF1/SF2 timestamps of Settlement Instructions in case of Insolvency situation [▶ Error! Bookmark not defined.]	CB
View Standing/Predefined Liquidity Transfer Order Details [▶ Error! Bookmark not defined.]	CSD/CB

6.2 Sitemap for T2S GUI

6.2.1 Reader's Guide

The sitemap annex is structured along the first and the second GUI menu level. It provides you with a formalised illustration of all screens (pictured as rectangles) and their related buttons (pictured as arrows). The illustration helps you to get an overview of all GUI screens and their interrelation, indicated by the arrows.

General layout of a sitemap In general, each sitemap has the same layout. The header of the sitemap always indicates the GUI menu item pictured by the sitemap. The first 3 lines represent the 3 main menu levels.

Menu Name	
Menu Level 1	
Menu Level 2	
Menu Level 3	

Illustration 3: Sitemap menu levels – GUI path

In lines 4 to 6, the single GUI screens are pictured following their business logic, i.e. starting with *search/list* screens in line 4, *details* or *enter* screens in line 5 and finishing with *revisions/audit trail – list* screens in line 6.

Search / List Screen	
Details / Enter Screen	
Revision / Audit Trail	

Illustration 4: Sitemap menu levels - screens

Within these lines, regular rectangles represent a menu item, rounded rectangles represent a screen.

Menu Securities	
Menu Level 1	M1 Securities
Menu Level 2	M1.1 Securities Account M1.2 Settlement
Menu Level 3	M1.1.1 Securities Positions M1.1.2 Securities Postings M1.1.3 Securities Restriction M1.2.1 Settlement Instructions M1.2.2 Intra-Position Movements M1.2.3 Maintenance Securities Instructions M1.2.4 Settlement Instruction Alignments M1.2.5 Data Changes M1.2.6 Securities Positions

Illustration 5: Menu item and sitemap screen illustration

Interrelation between screens Arrows between the rectangles represent an interrelation, while the button that has to be clicked on to jump from one screen to another is written across the corresponding arrow.

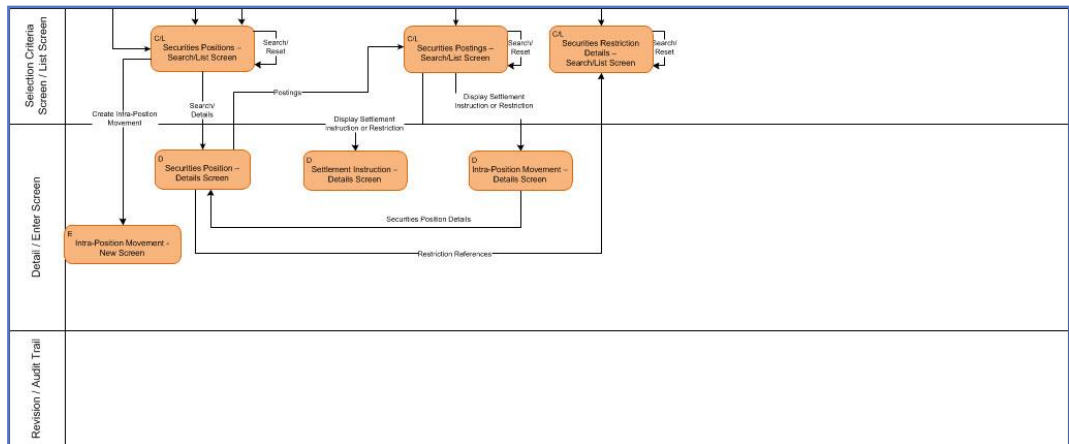

Illustration 6: Screen interrelation

Menu item and screen rectangles

The screen rectangles follow the same colour-coding as the GUI (see menu structure [▶ **Error! Bookmark not defined.**]). The classification found in the top left corner of each rectangle provides the following detailed information:

- ▮ Capital M for menu followed by max. 3 digits indicating the main menu item (1 for securities, 2 for cash, 3 for services, 4 for static data, 5 for monitoring) and following menu levels.
- ▮ Screen classification (C/L for search/list screen, C for search screen, L for list screen, D for details screen, E for enter screen).

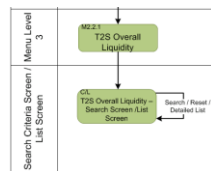

Illustration 7: Sitemap screen with classification and with button

Screens with a different colour

On some sitemaps you will also find screens illustrated in a different colour than it is foreseen for the respective T2S menu. These particular screens represent an alternative navigation to the same respective screen. These specific screens appear on the same menu level than the regular screens.

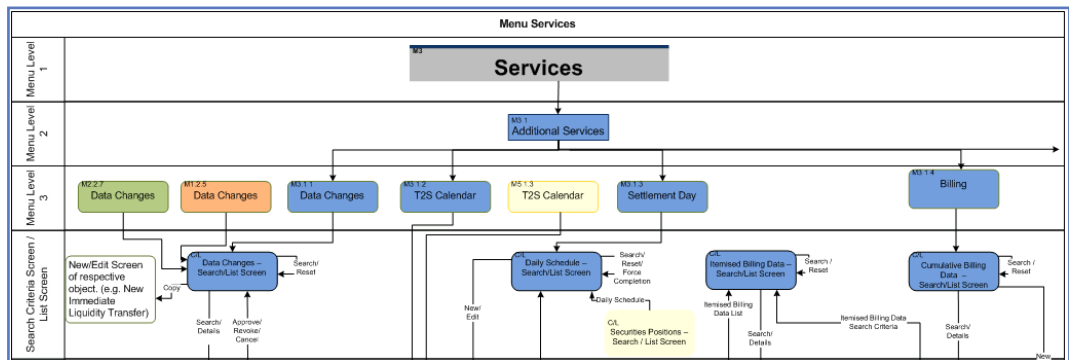

Illustration 8: Screens with a different colour

Interrelation between sitemap parts

Because of the size of the sitemap it has been split into several parts. You can recognise the use of several sitemap parts by an arrow leading to the next sitemap part.

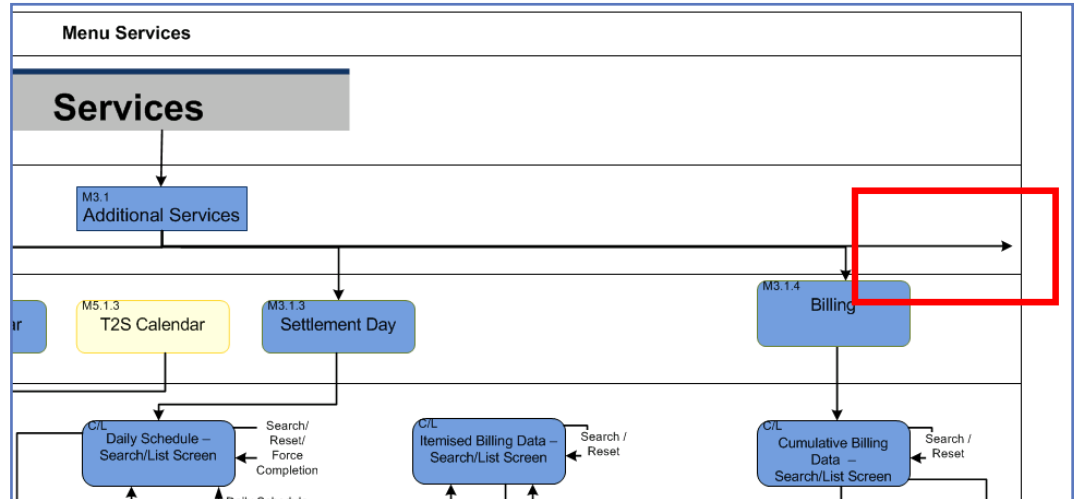

Illustration 9: Sitemap part interrelation

The static data sitemap for example is divided into 14 different sitemaps because of the wealth of information. Therefore it is recommended to read the sitemap from the top to the bottom and then from the left hand-side to the right hand-side.

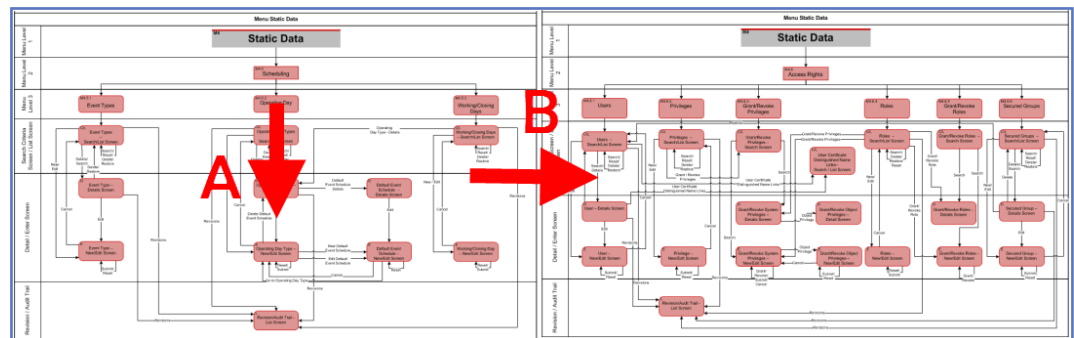

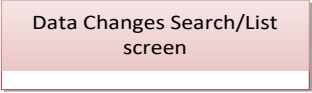

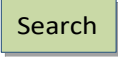

Illustration 10: How to read a sitemap

6.3 Sitemap for CoCo GUI

In the following sub-sections the reader may find the hierarchical, structured illustration of all the BDM screens and their interrelations.

You can find below the legend which explains the meaning of each object, i.e. screen, button, dotted (blue) arrow, solid (red) arrow illustrated in the following diagrams.

Object in the diagram	Description
-----------------------	-------------

	<p>The object represents a screen.</p>
	<p>When a button is displayed on the screen, a dotted blue arrow is shown as a link between the screen and the corresponding button.</p>
	<p>The object represents a button which is shown in the relevant screen.</p>
	<p>After a button is pressed, the result can be displayed either on the same screen or in a different screen (e.g. the details screen).</p>

6.3.1 Securities

6.3.1.1 Securities Account

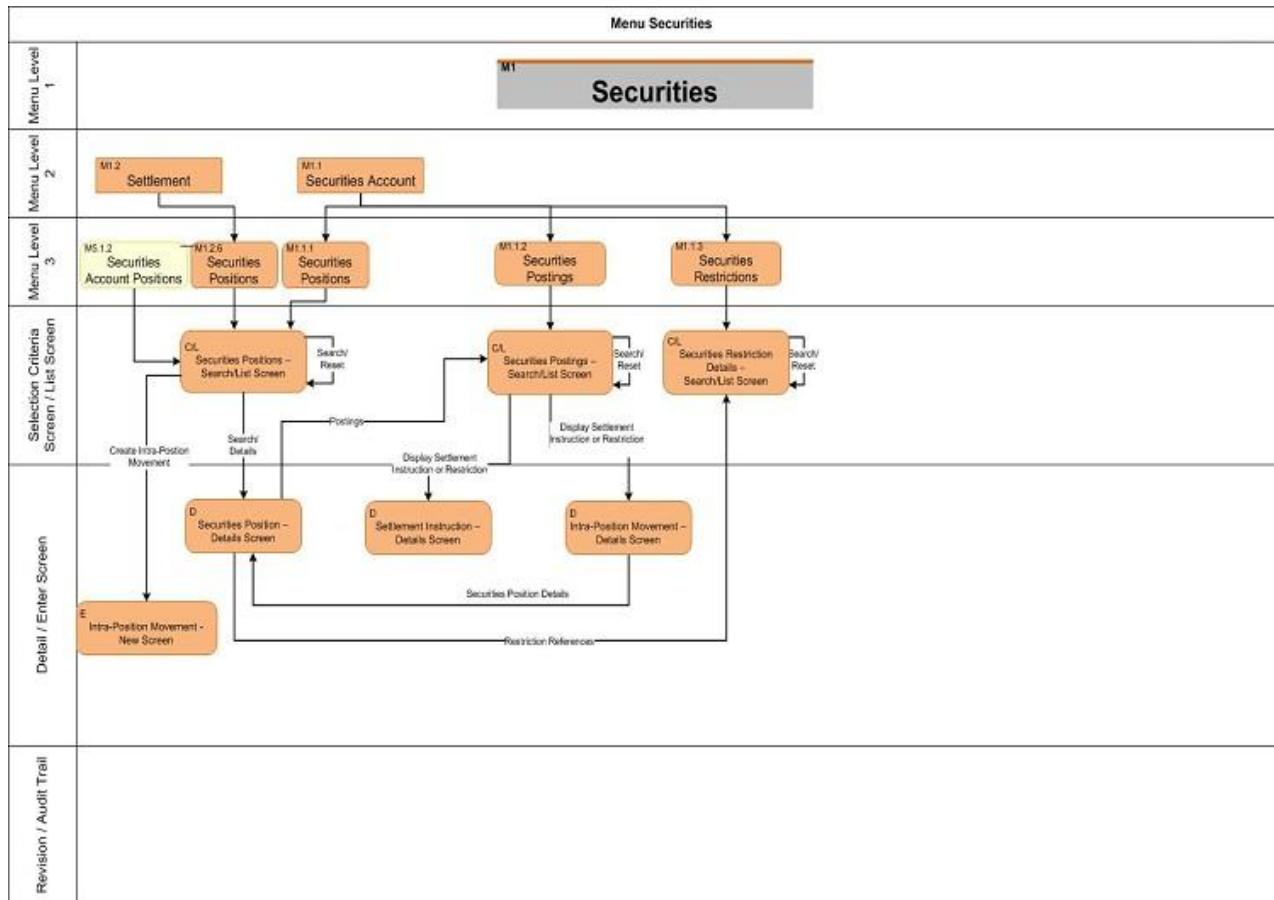

6.3.1.2 Settlement

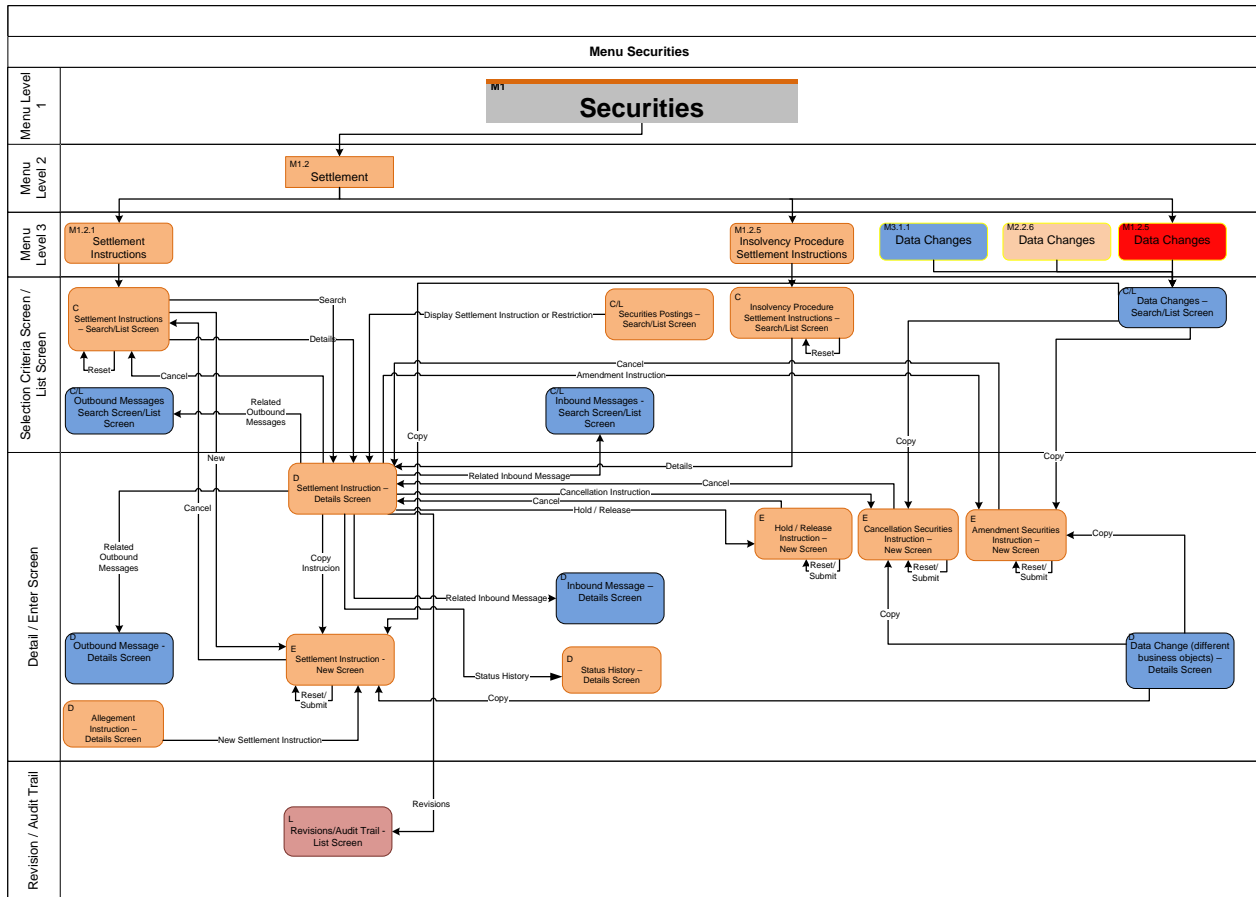

6.3.1.3 Settlement II

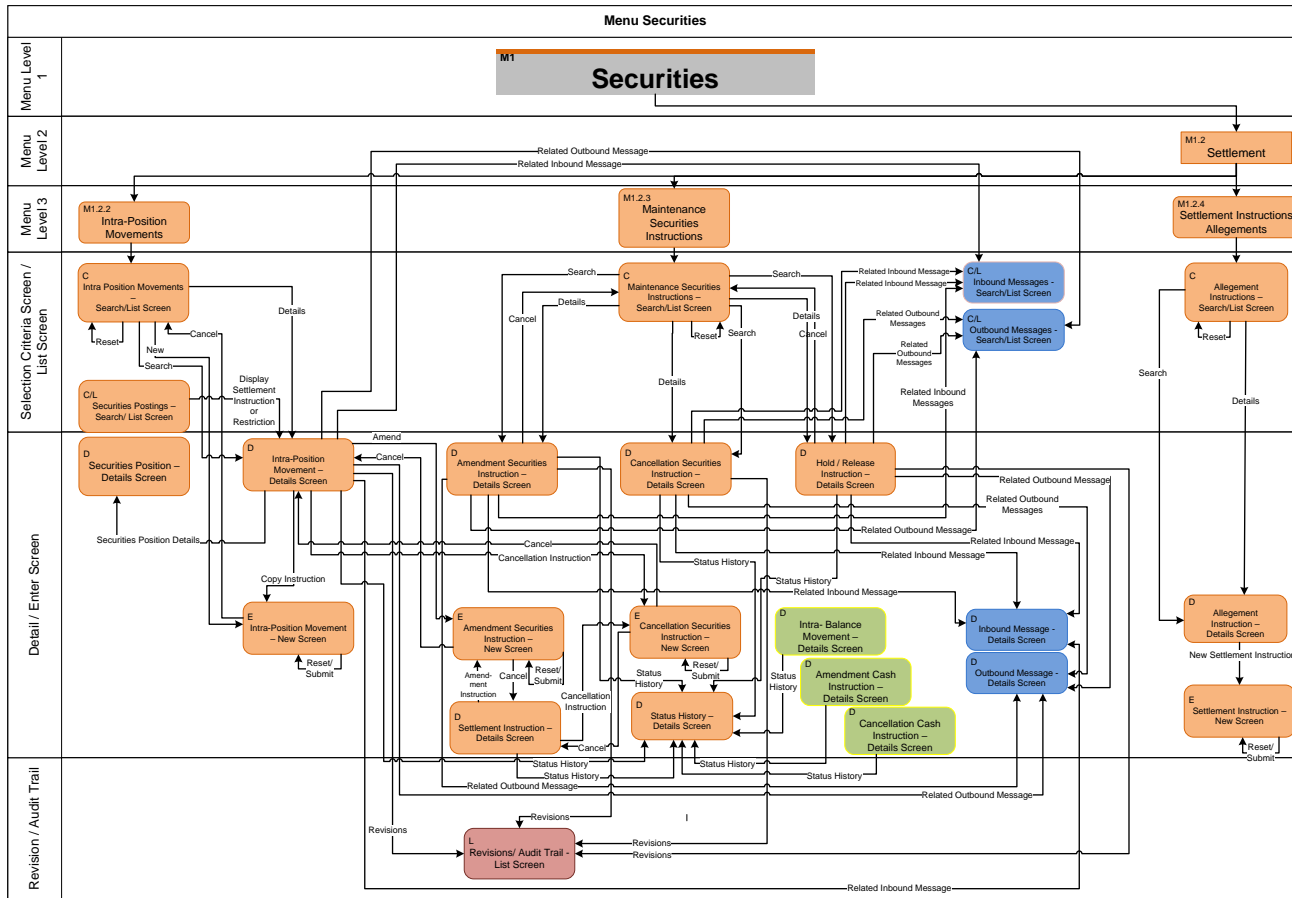

6.3.2 Cash

6.3.2.1 Cash Account

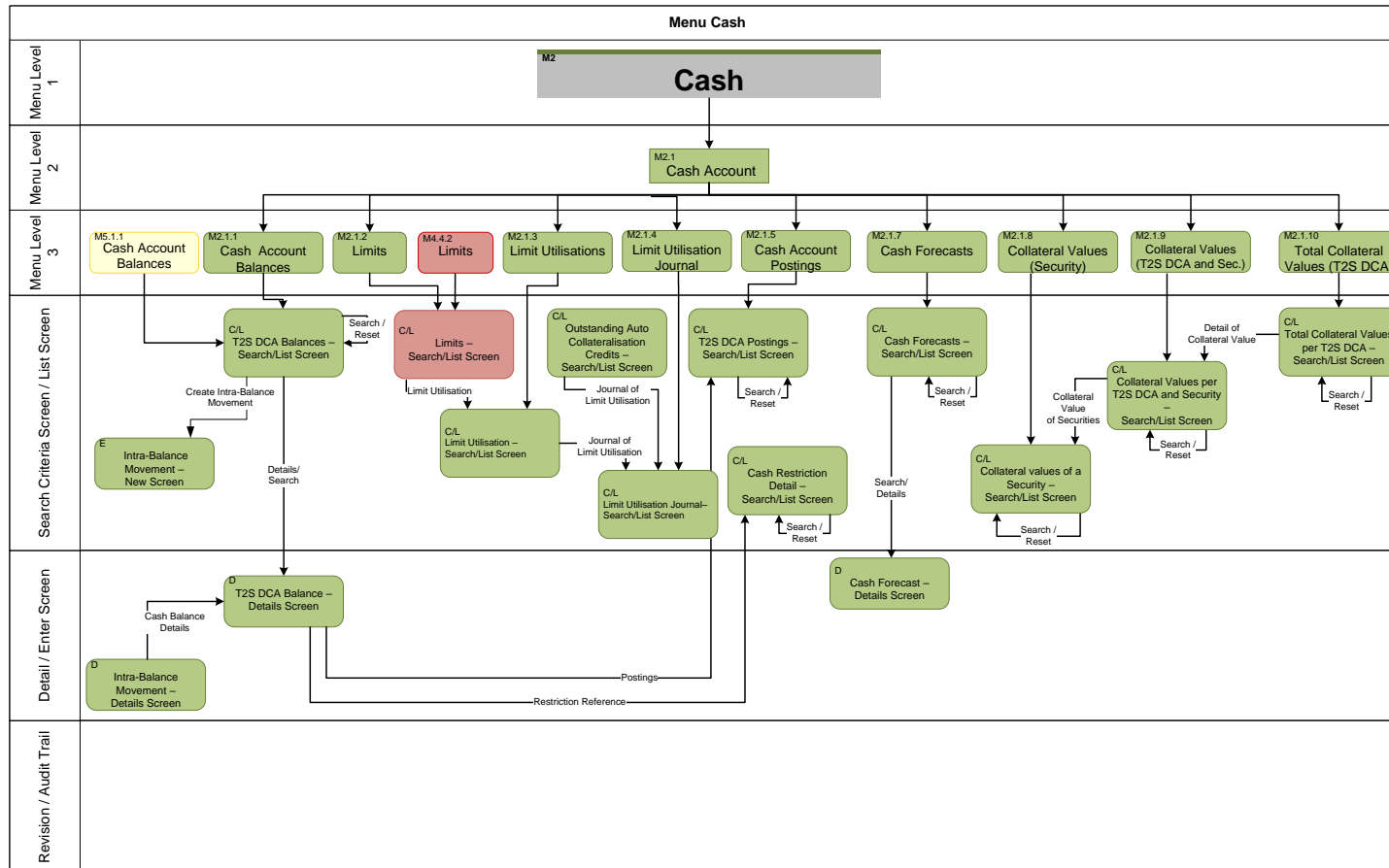

6.3.2.2 Liquidity

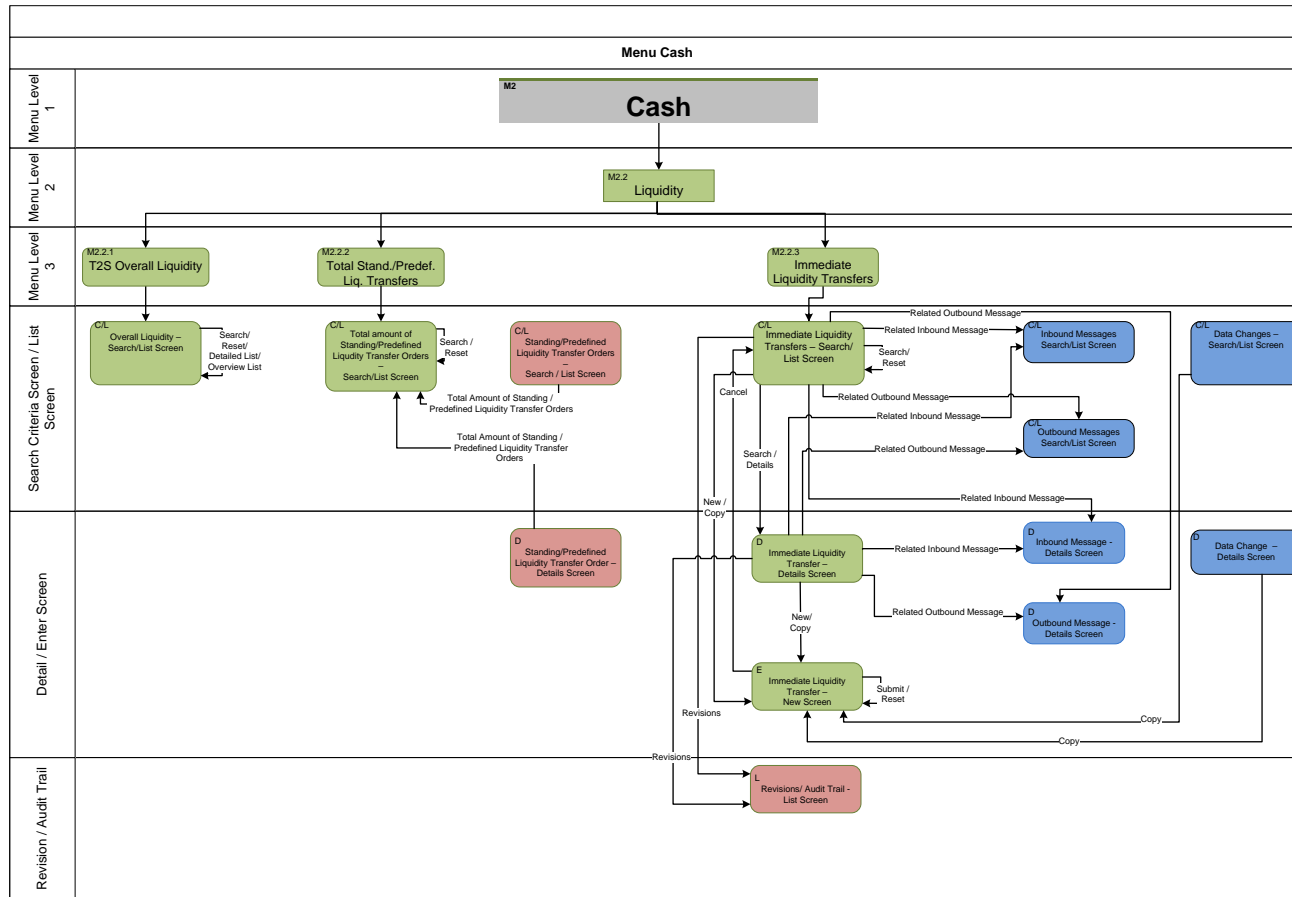

6.3.2.3 Liquidity II

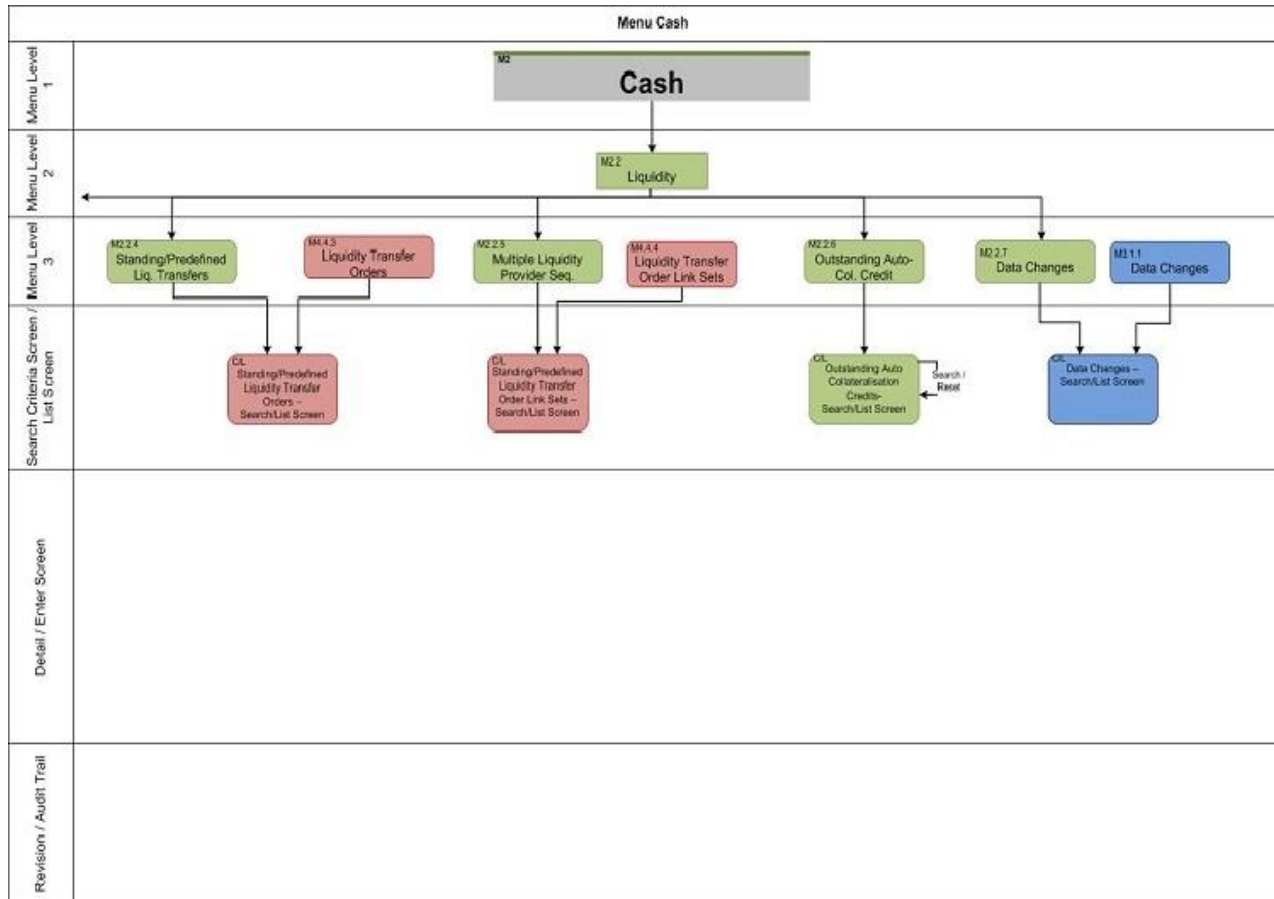

6.3.2.4 Settlement

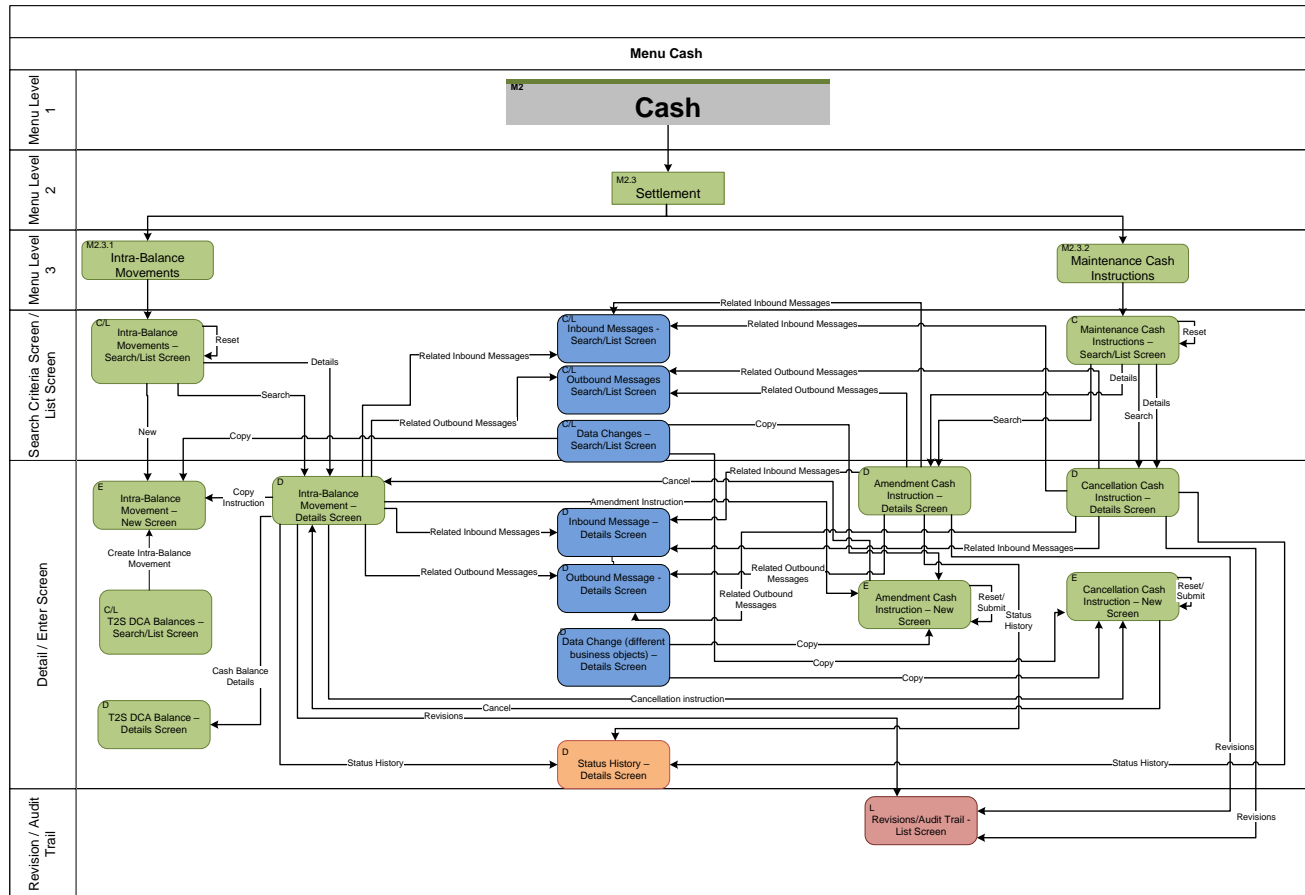

6.3.3 Services

6.3.3.1 Additional Services

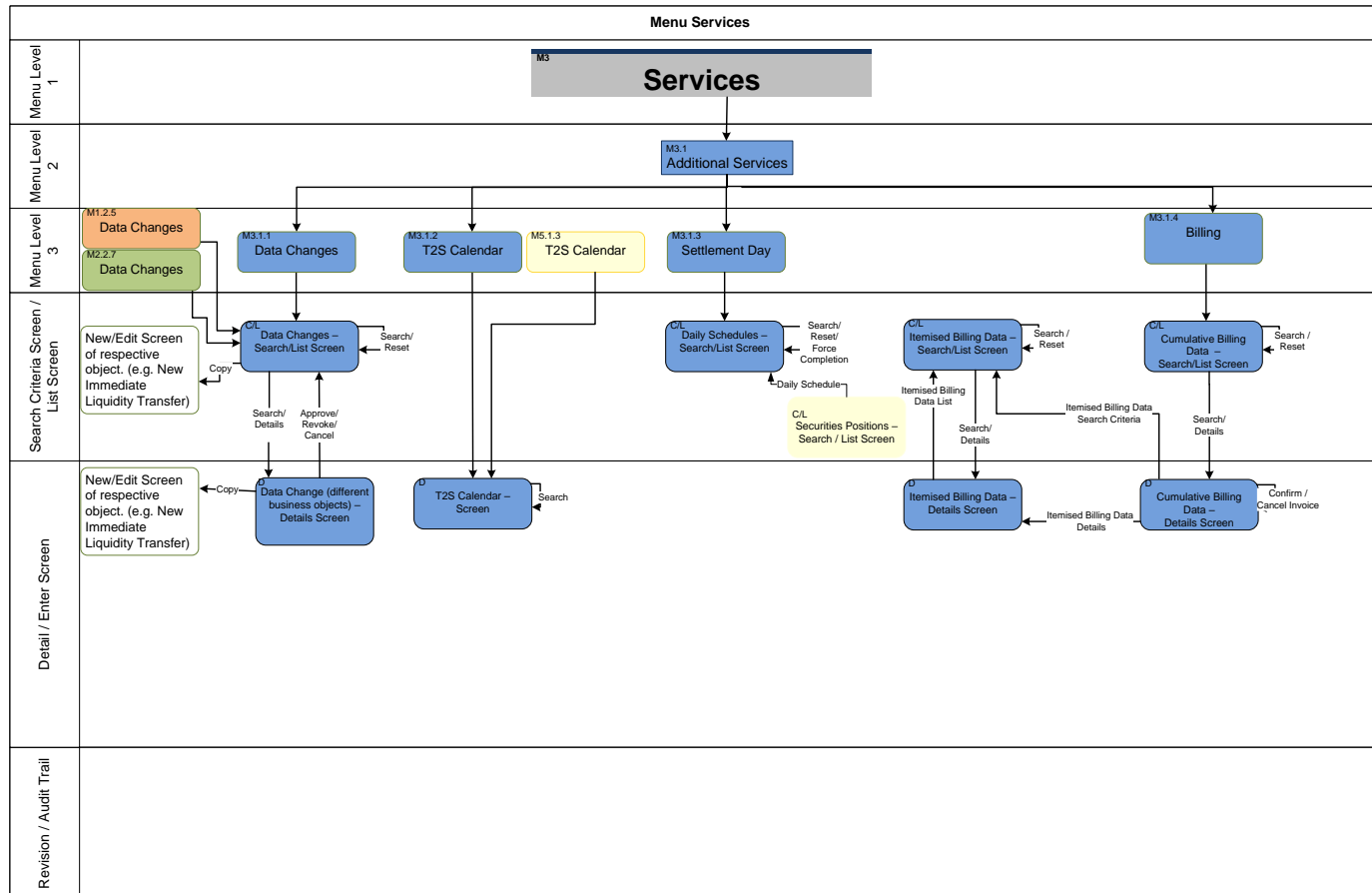

6.3.3.2 Additional Services II

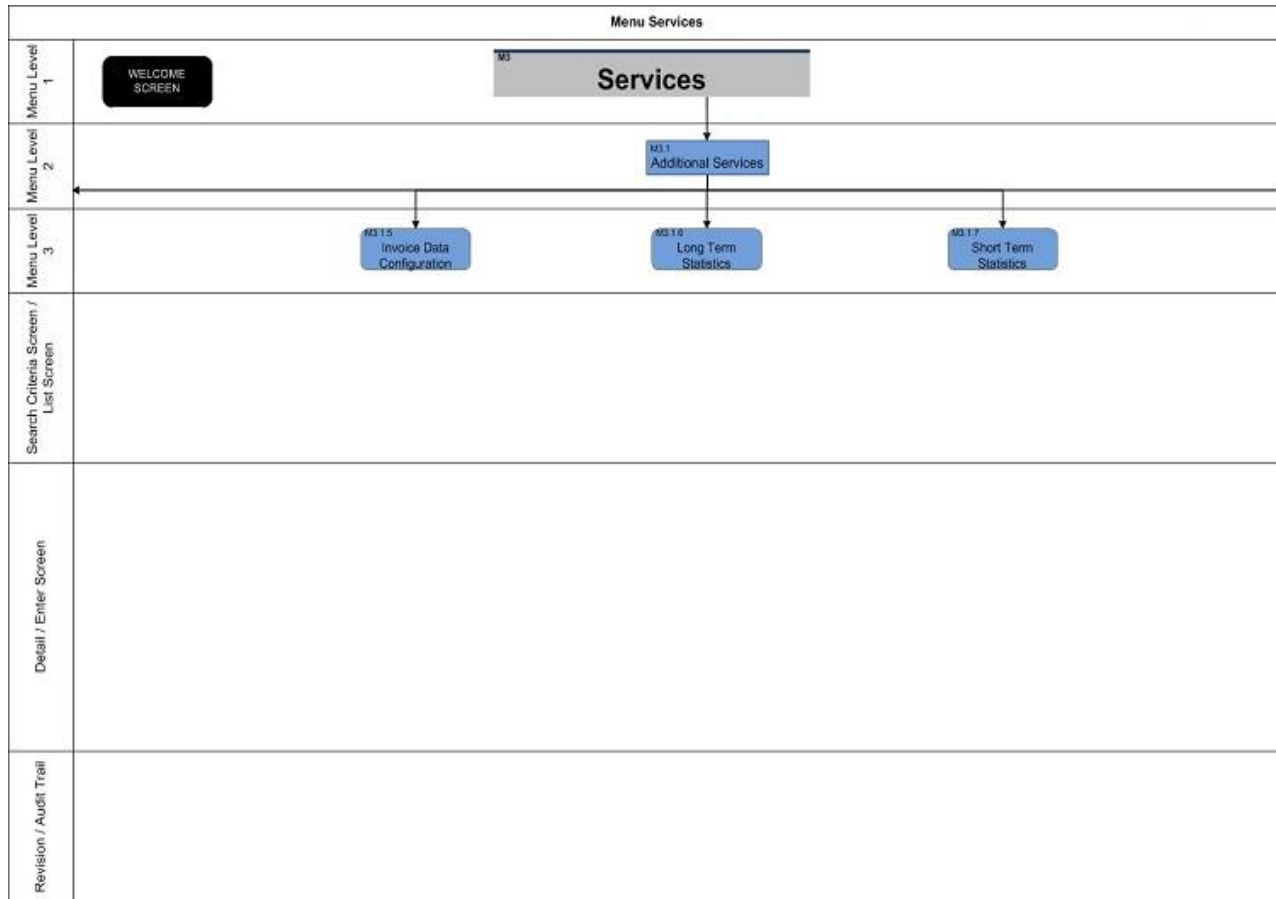

6.3.3.3 Additional Services III

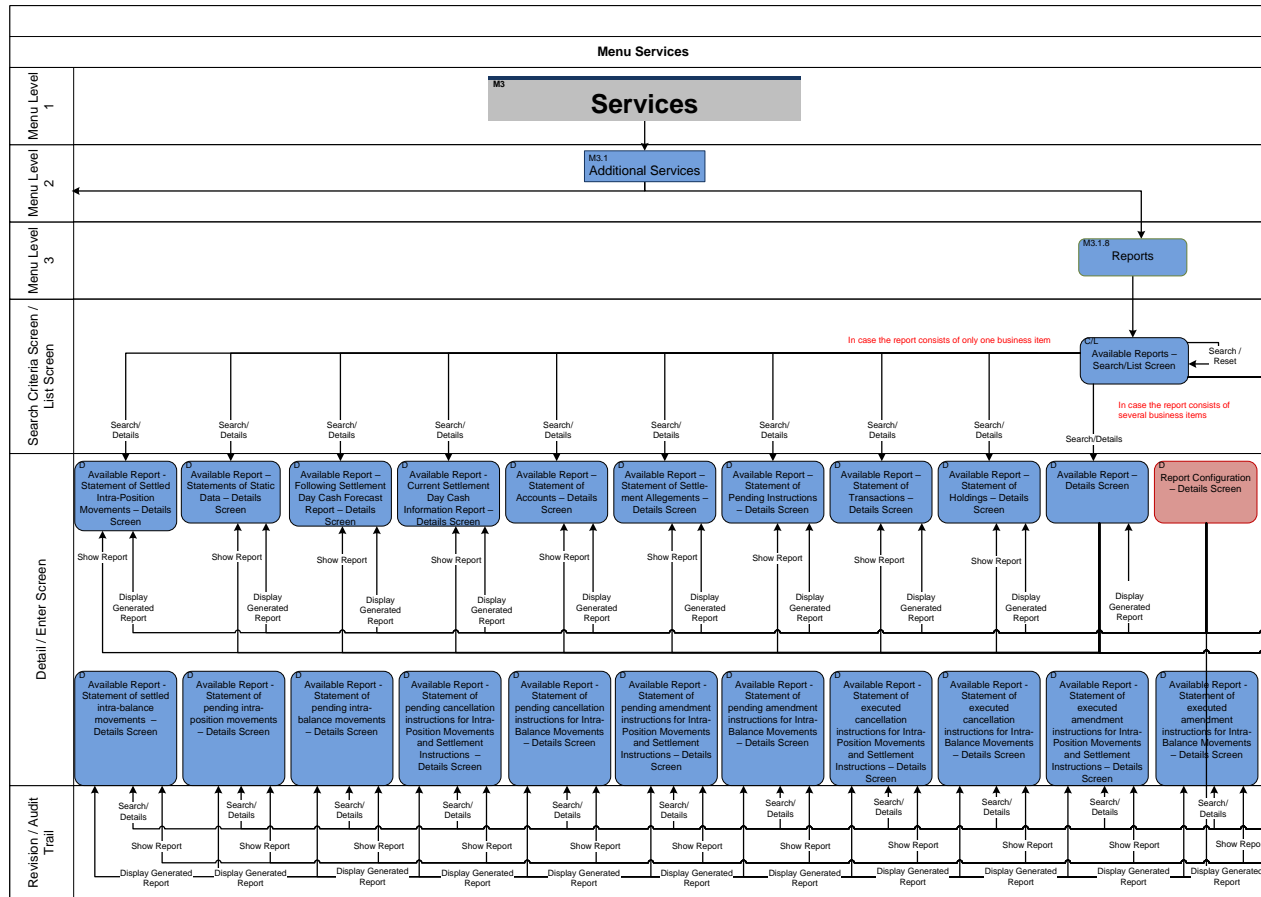

6.3.3.4 Additional Services IV

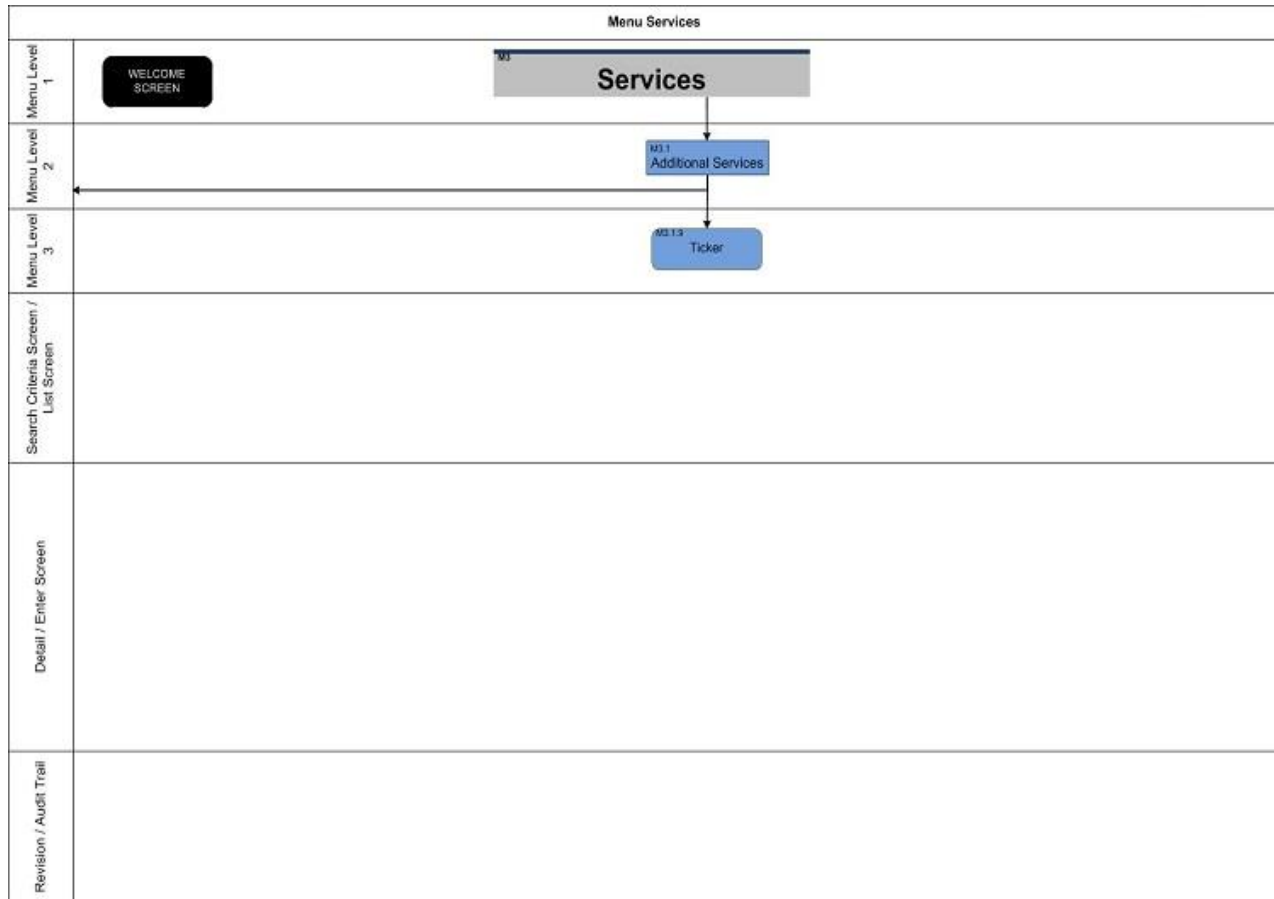

6.3.3.5 Additional Services V

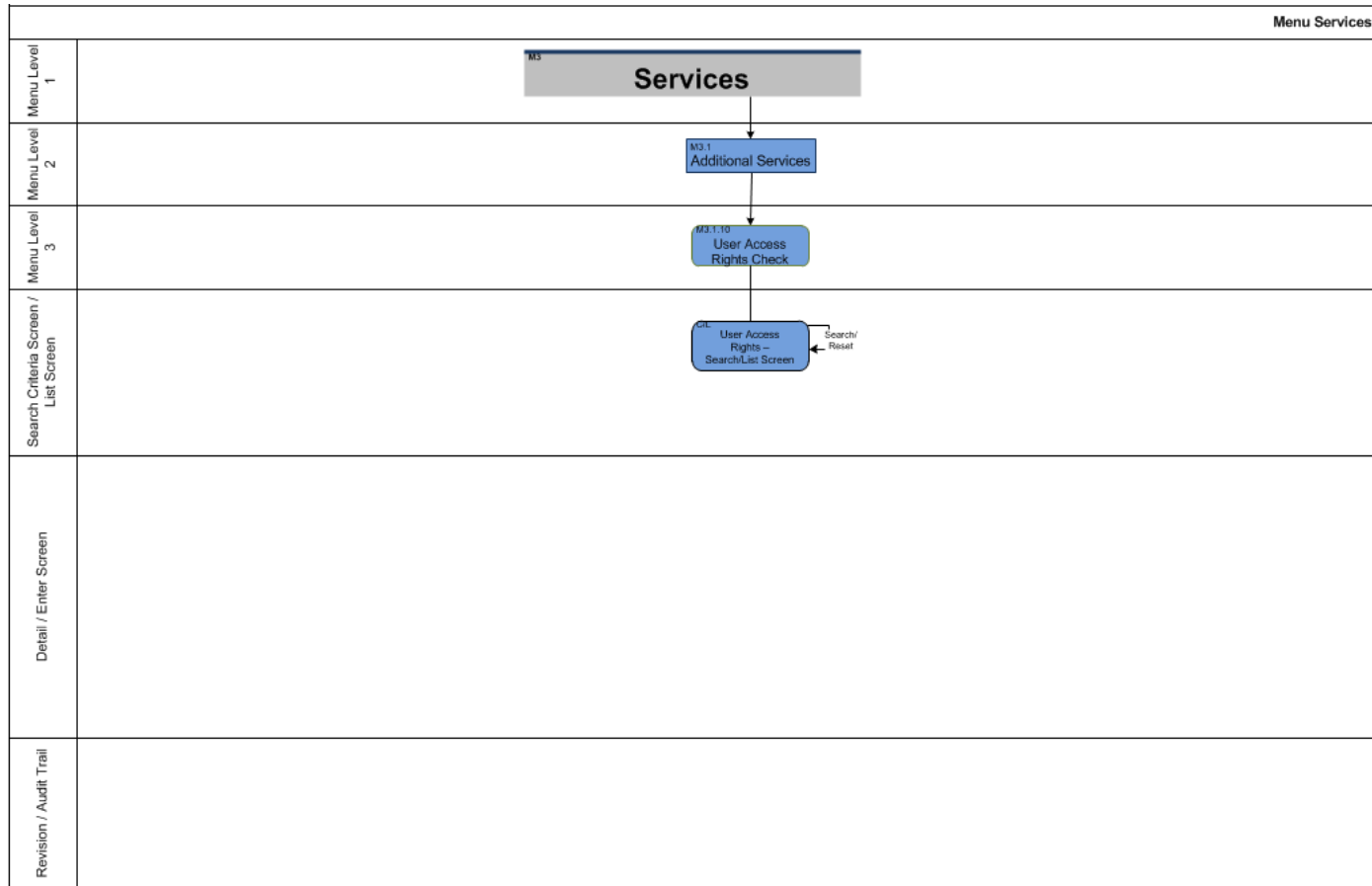

6.3.3.6 Additional Services VI

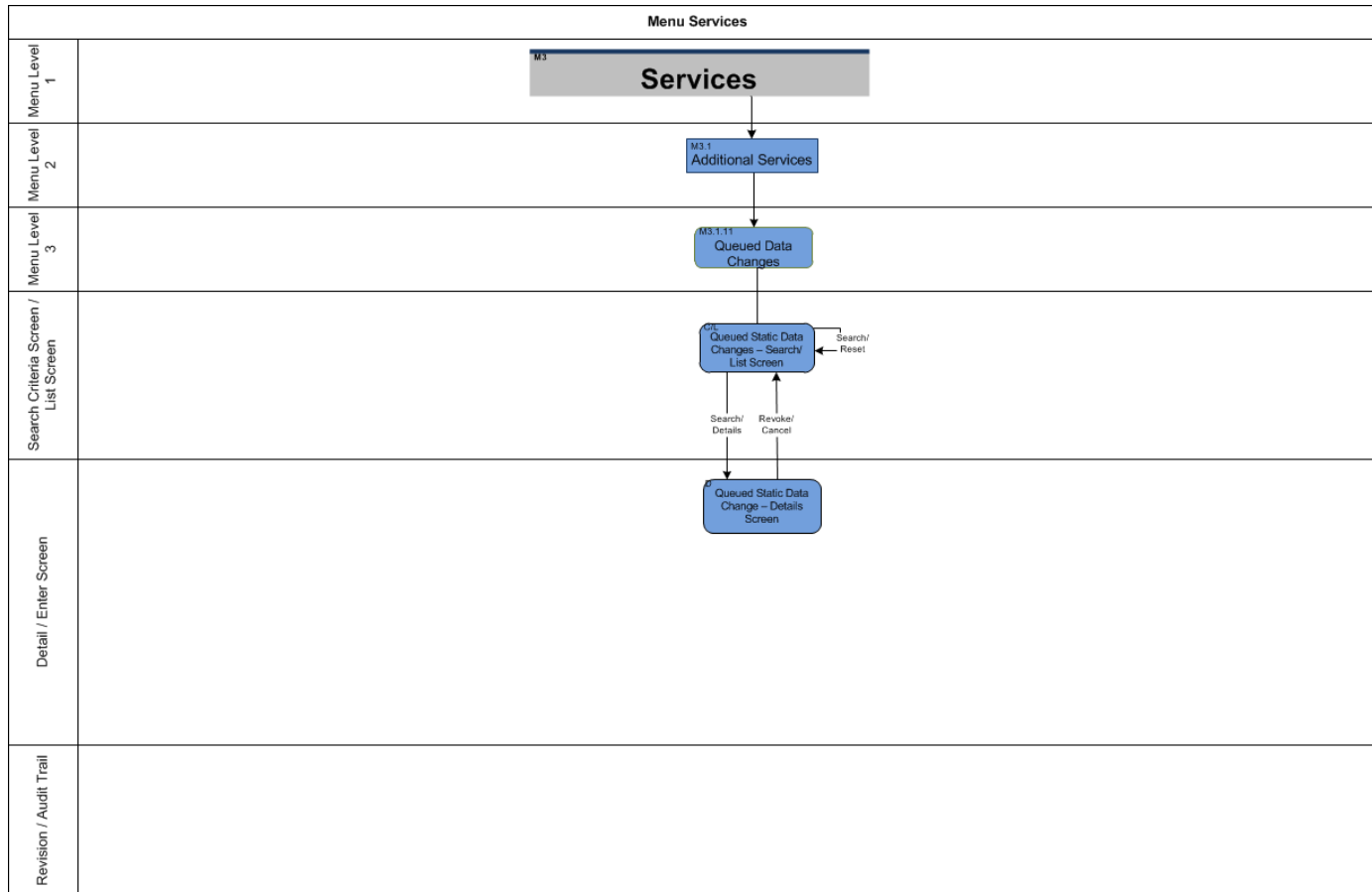

6.3.3.7 Communication

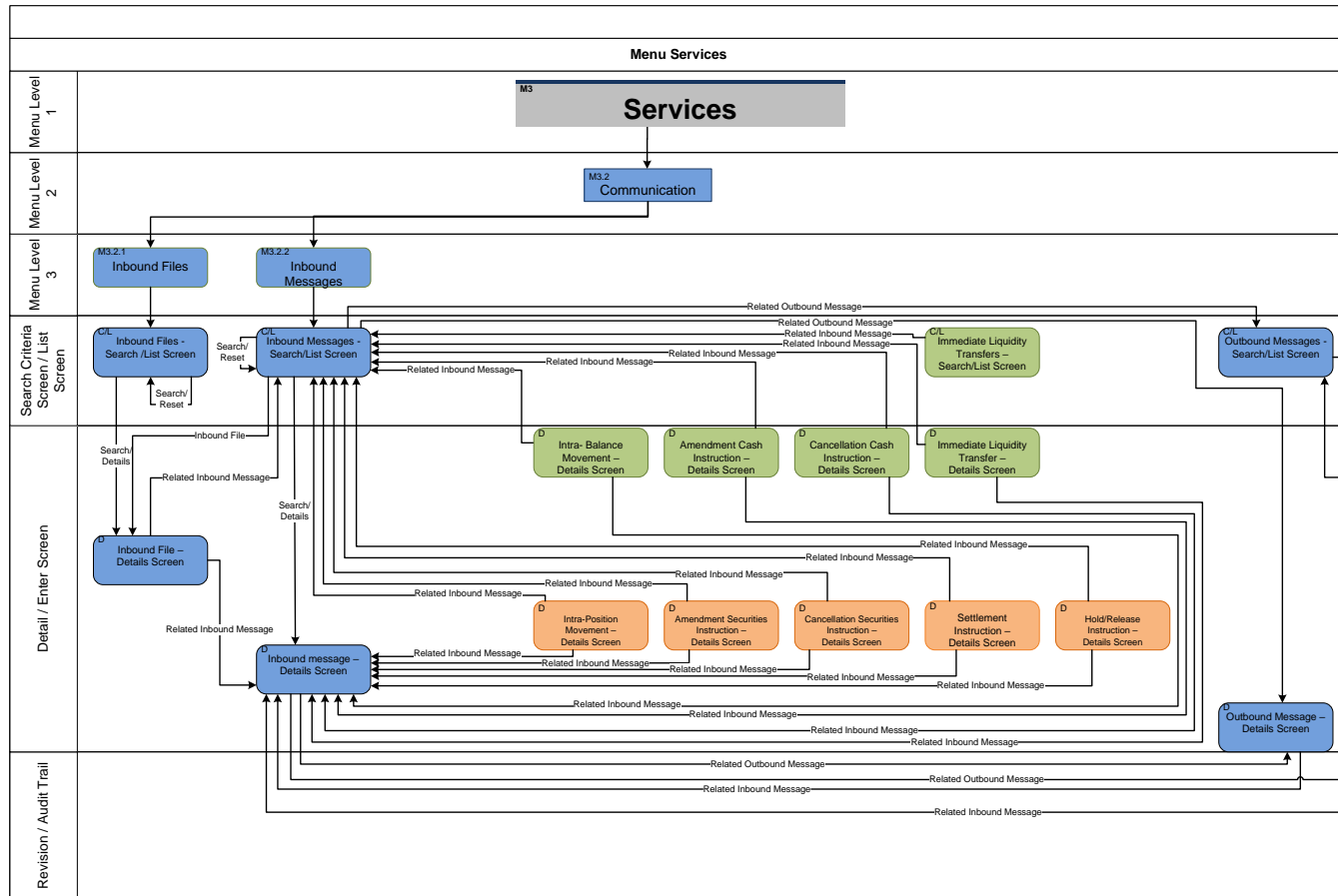

6.3.3.8 Communication II

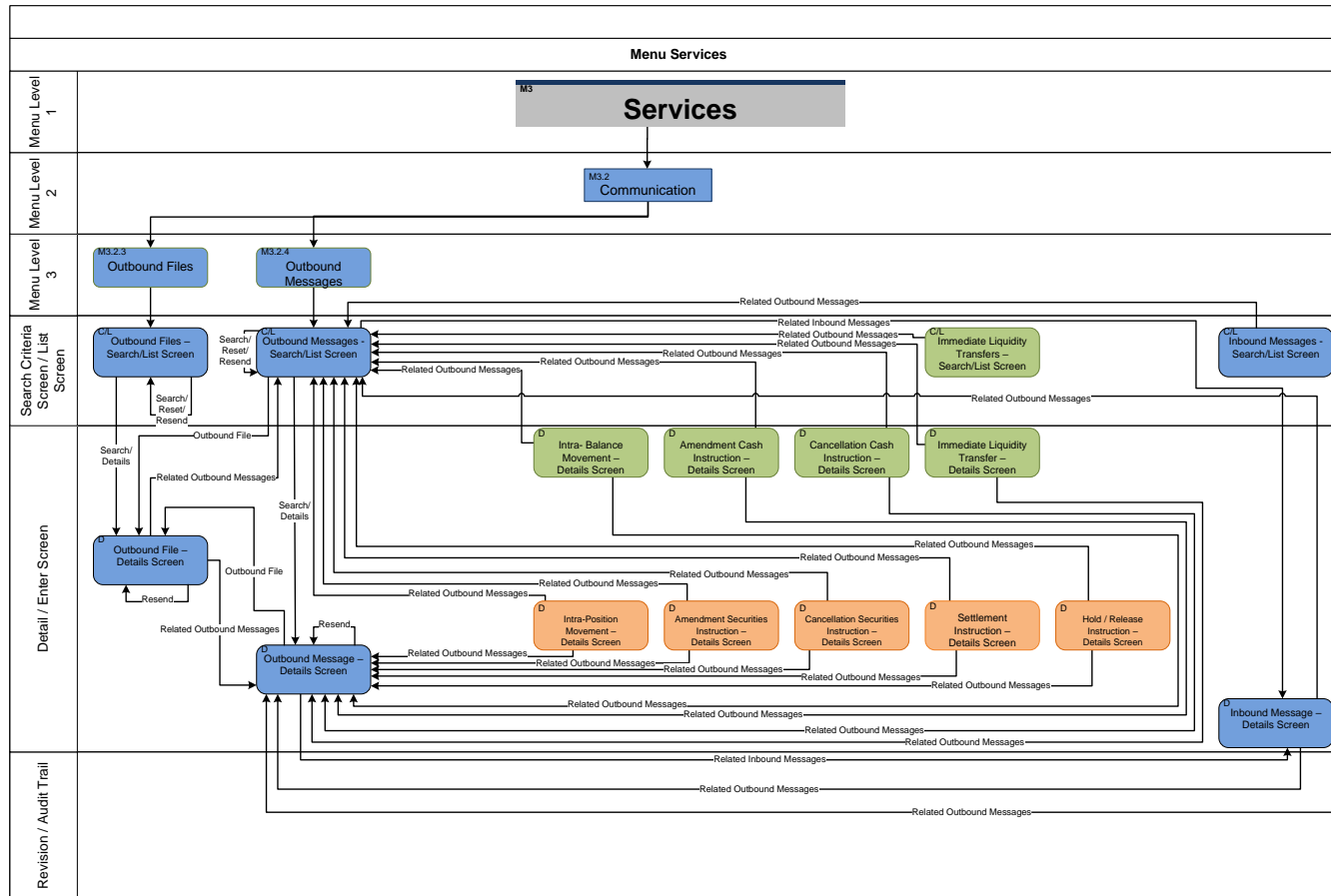

6.3.3.9 Communication III

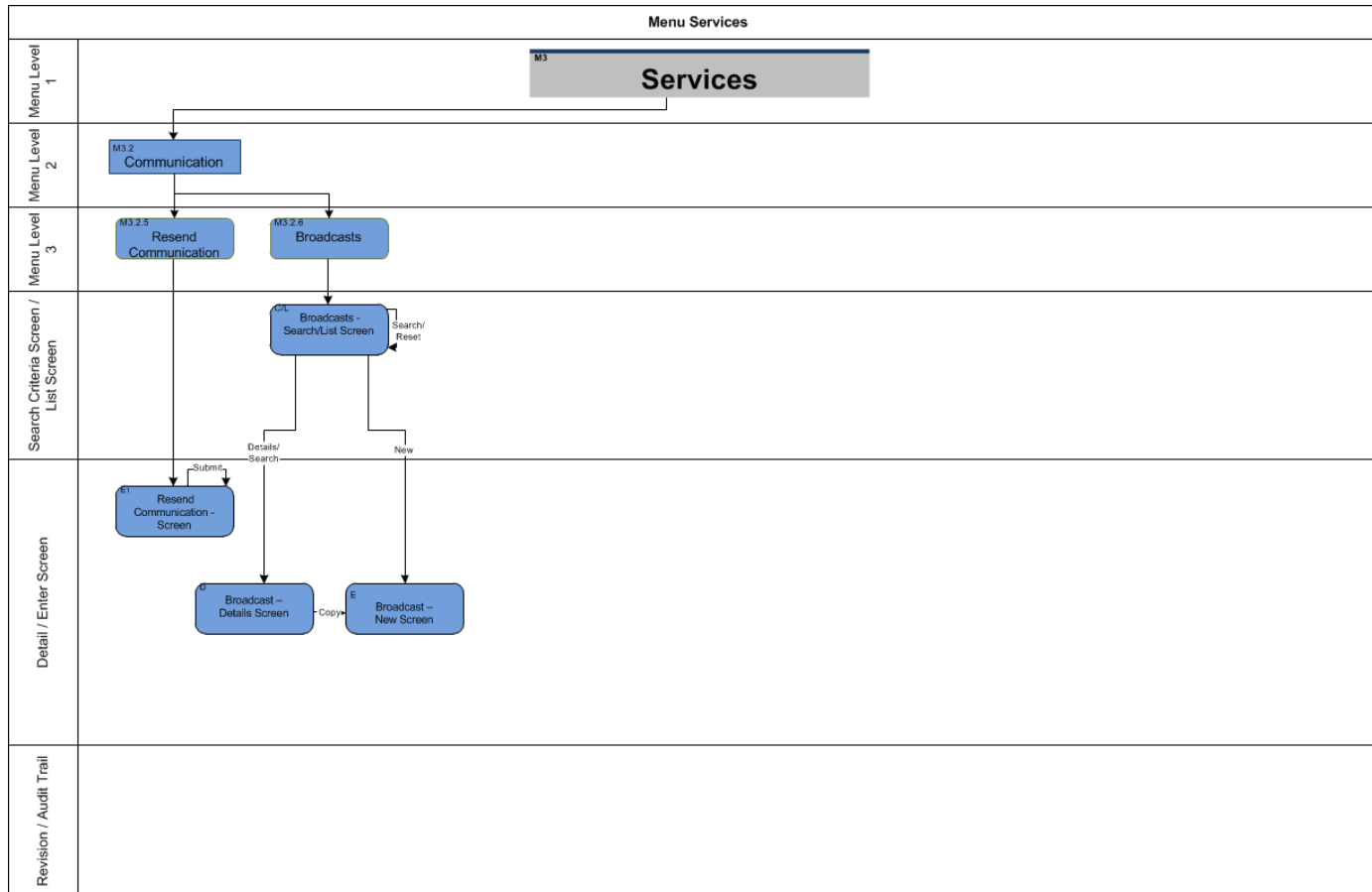

6.3.4 Static Data

6.3.4.1 Parties

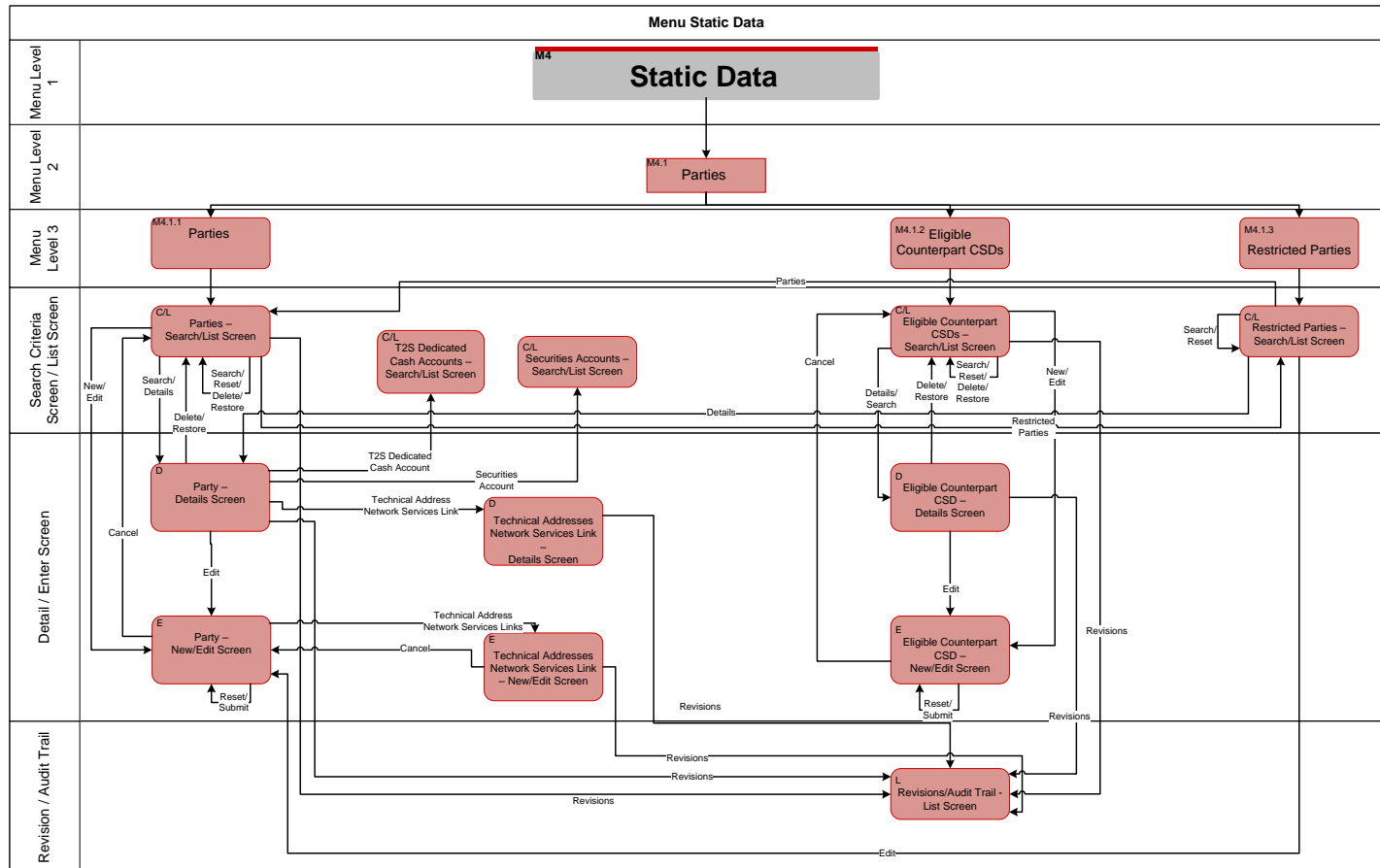

6.3.4.2 Securities

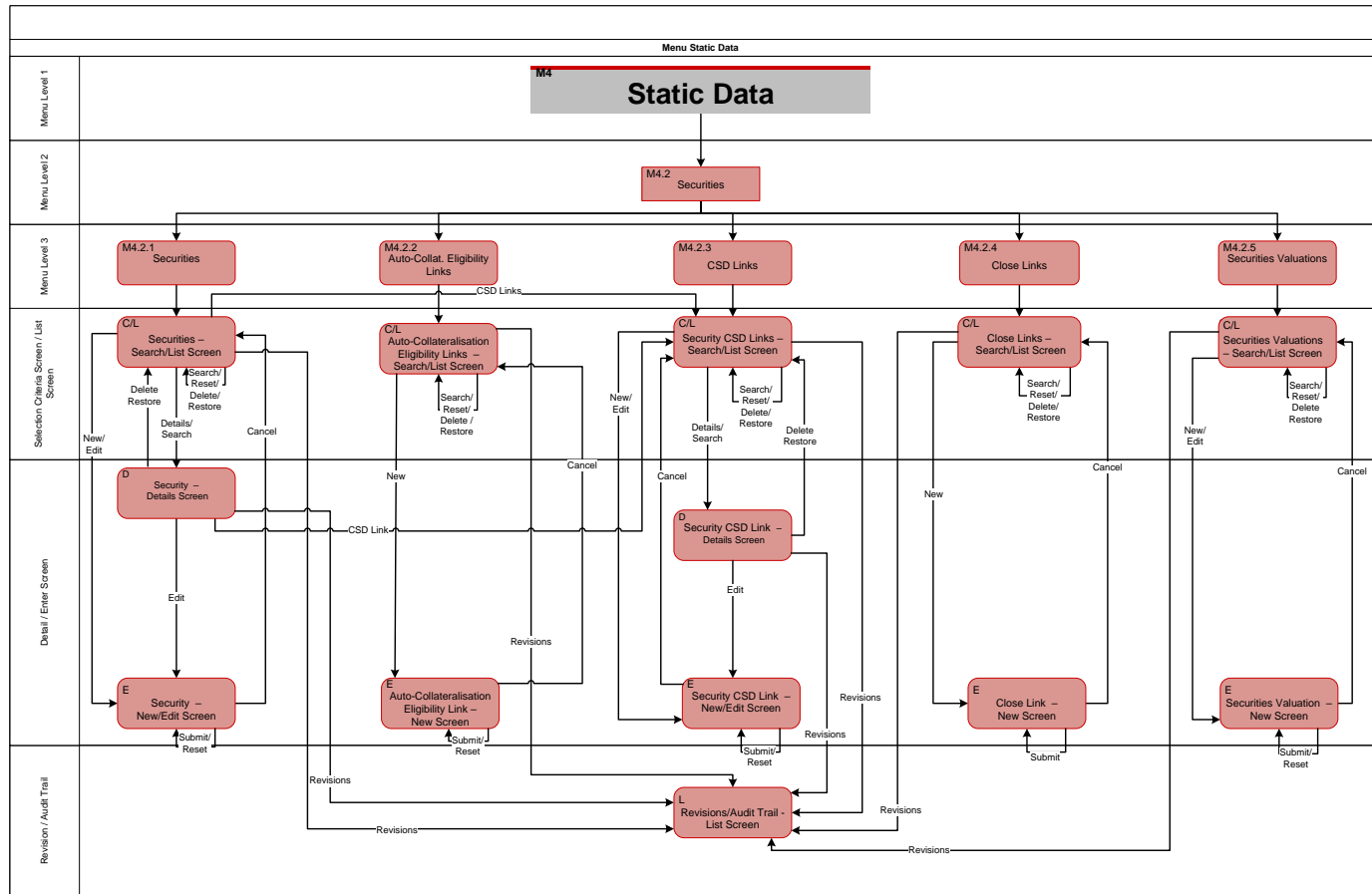

6.3.4.3 Securities Account

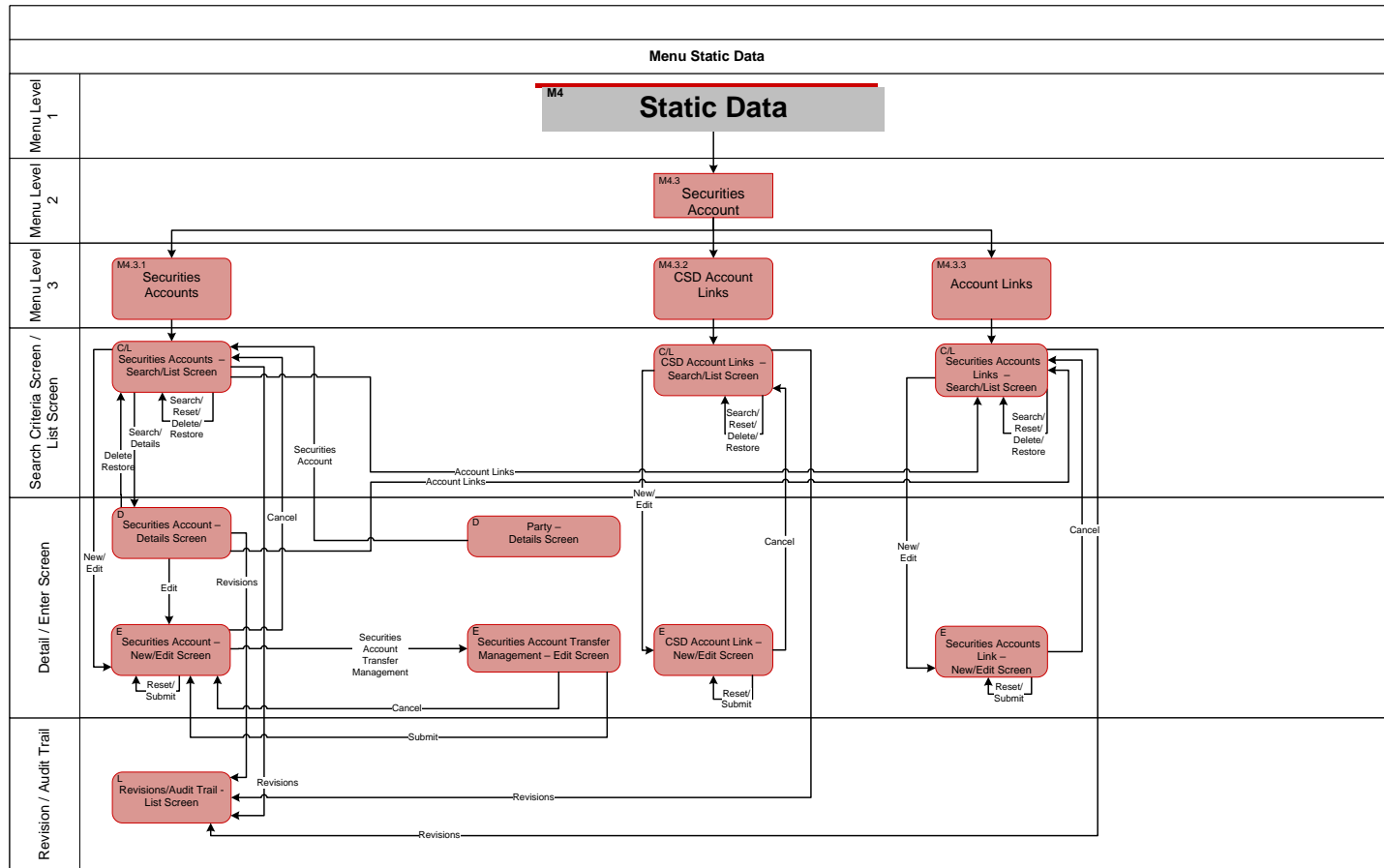

6.3.4.4 T2S Dedicated Cash Account

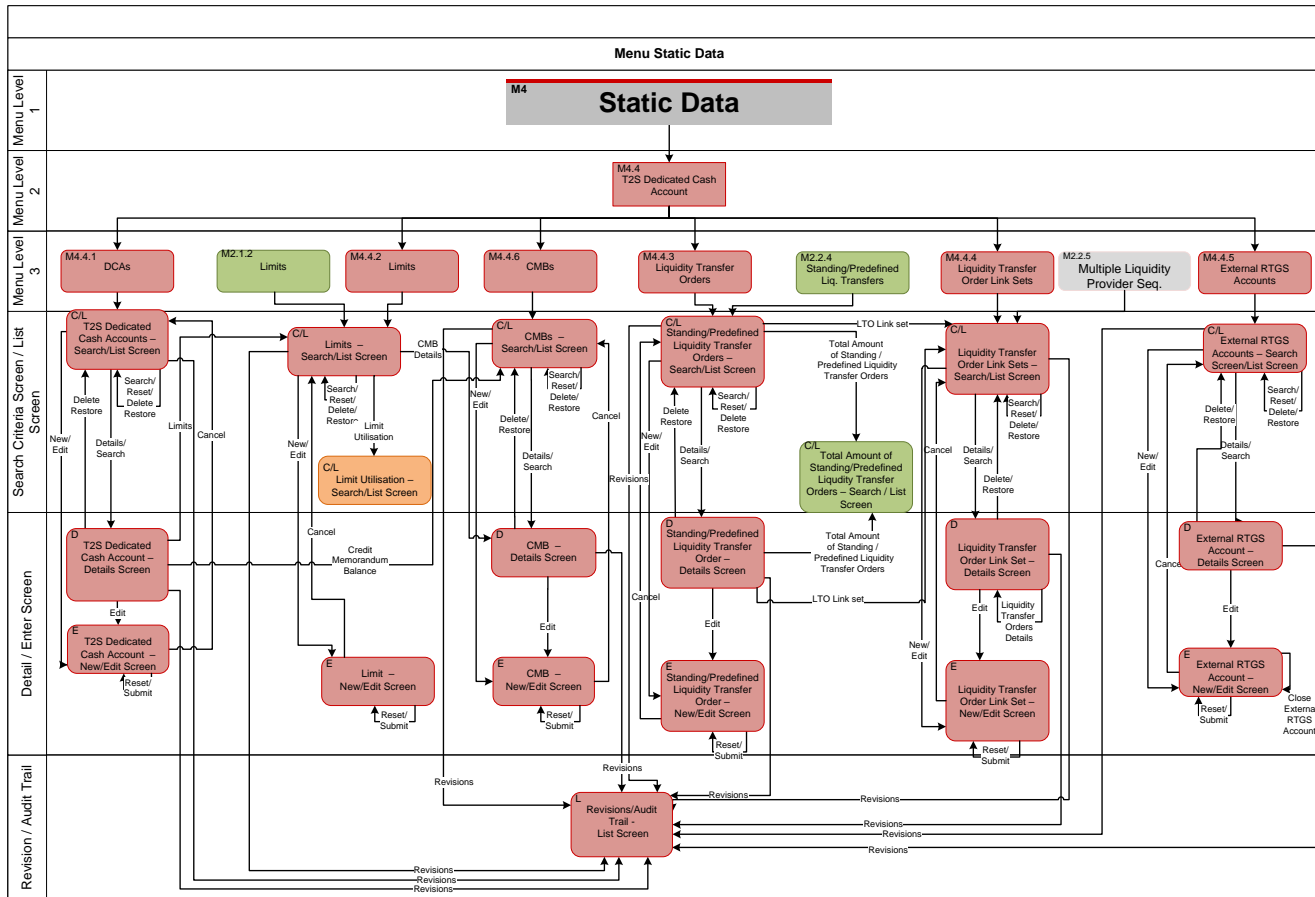

6.3.4.5 Scheduling

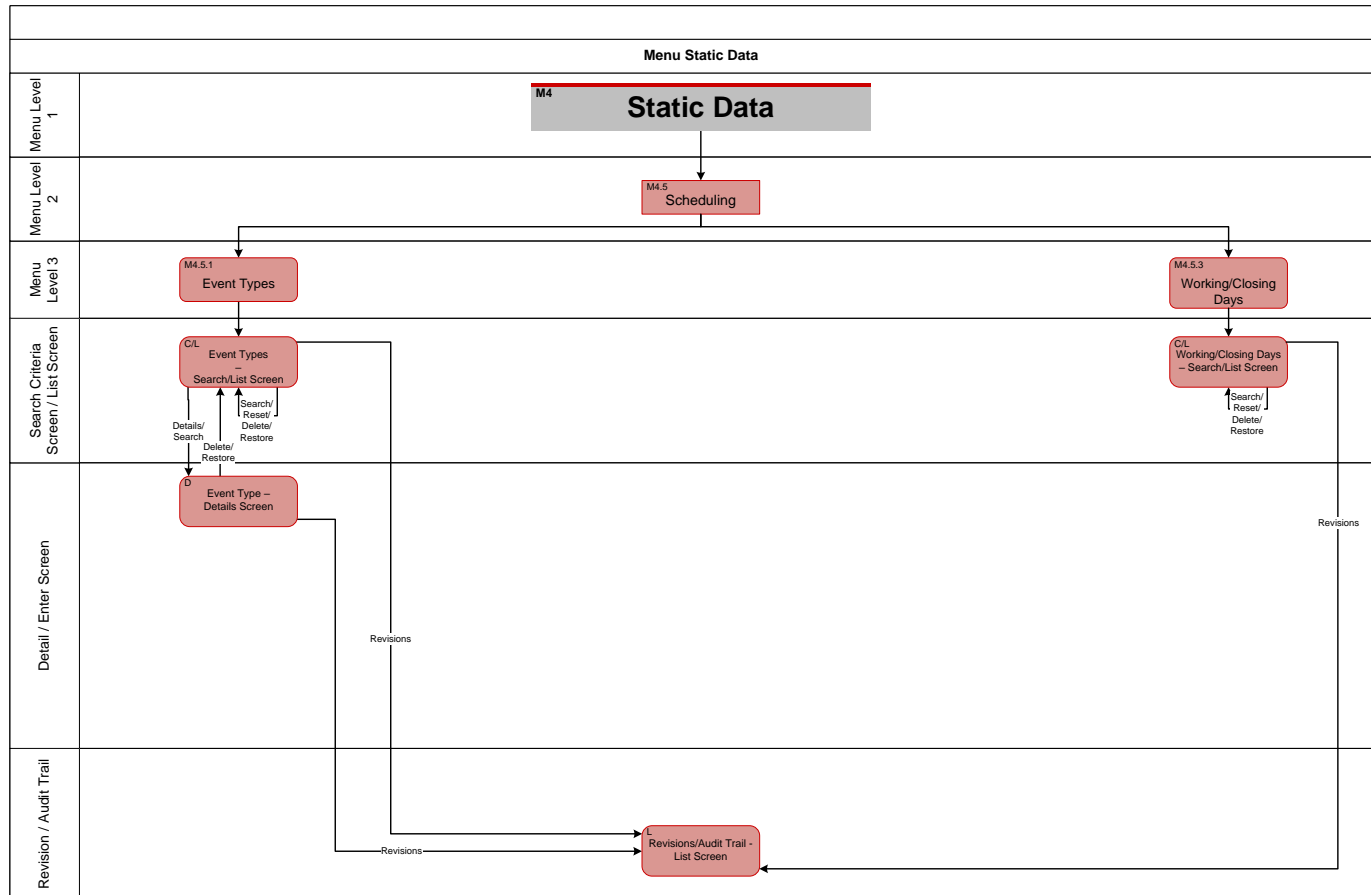

6.3.4.6 Access Rights

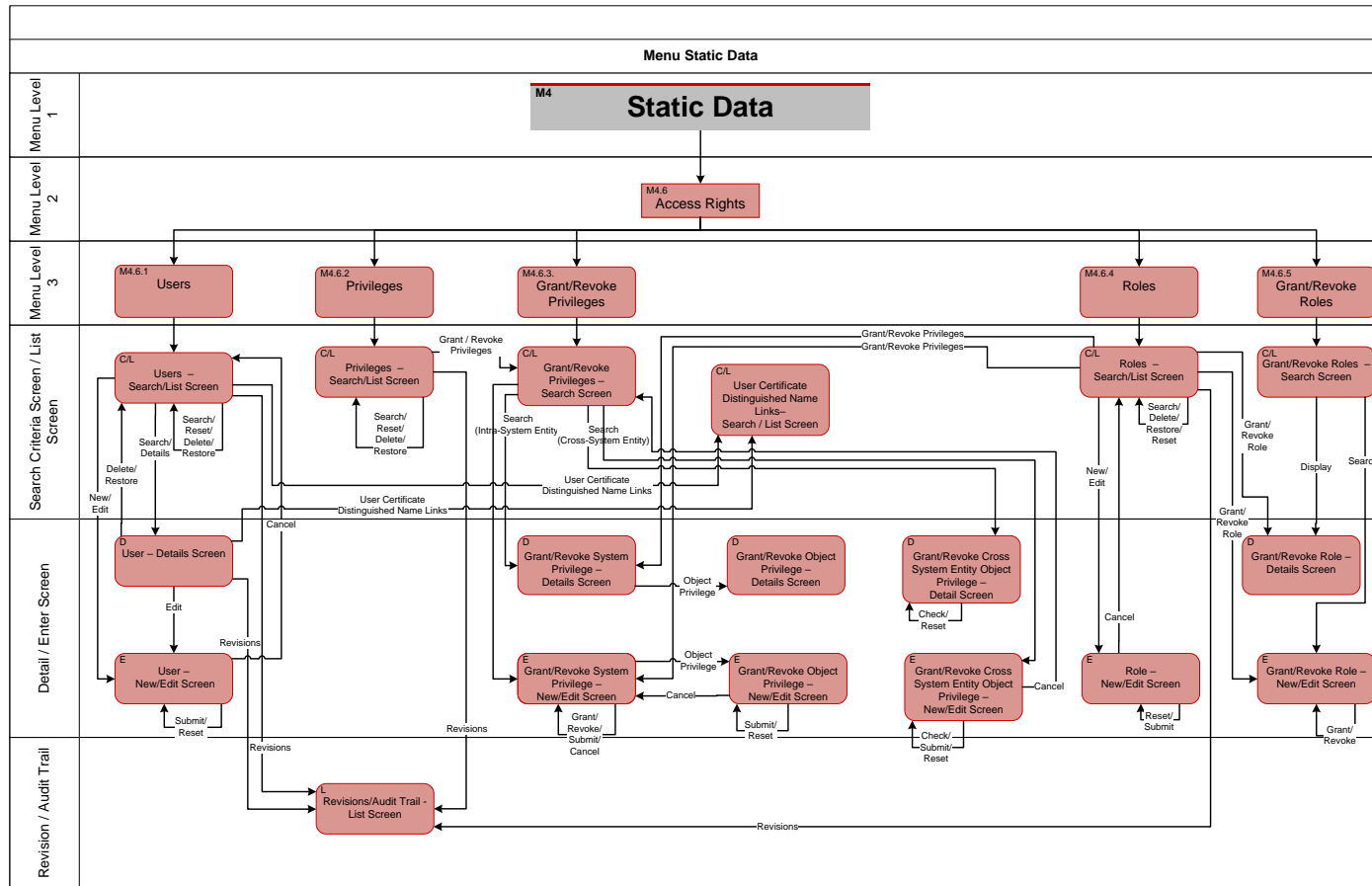

6.3.4.7 Access Rights II

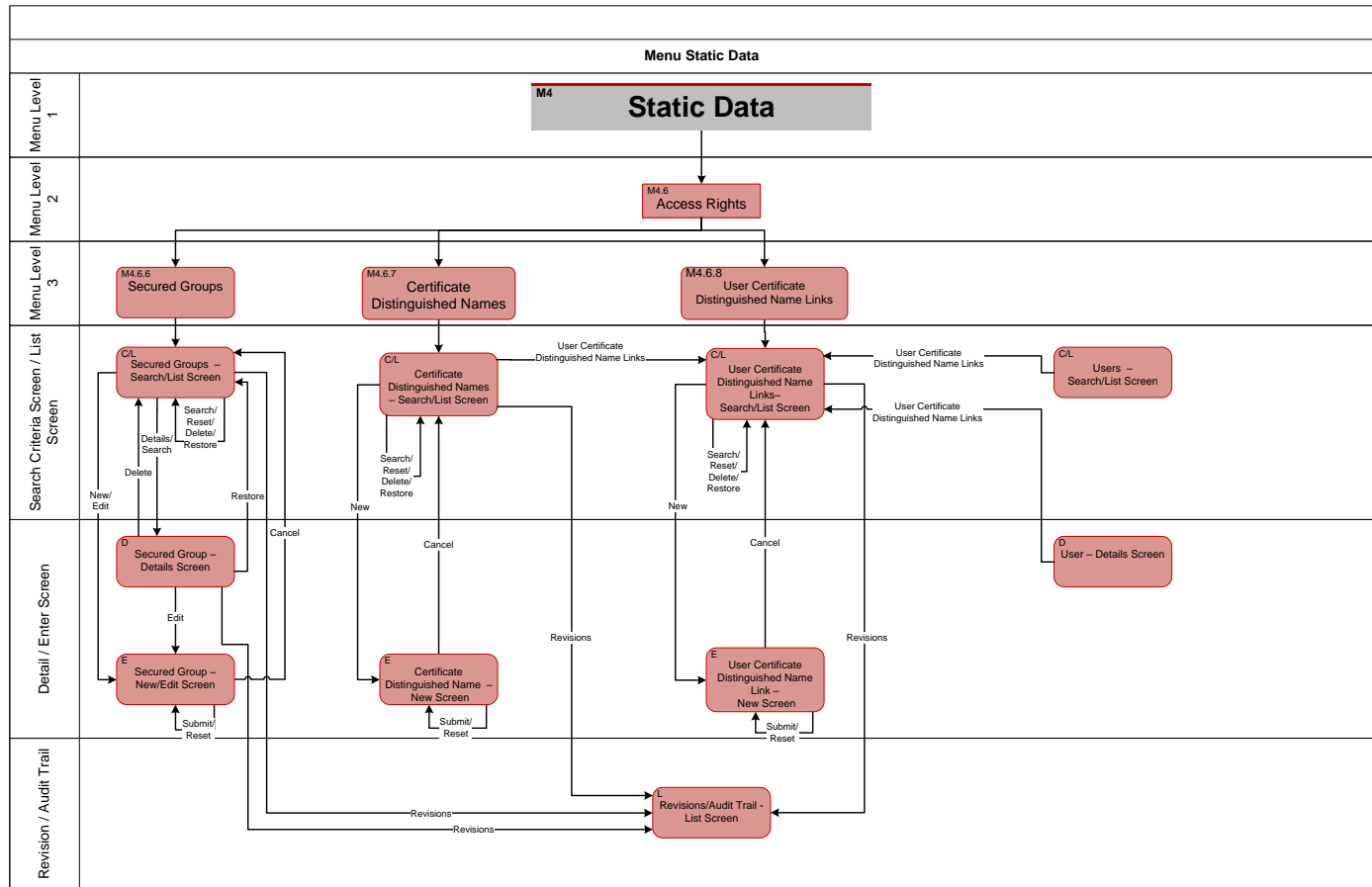

6.3.4.8 Messages and Reports

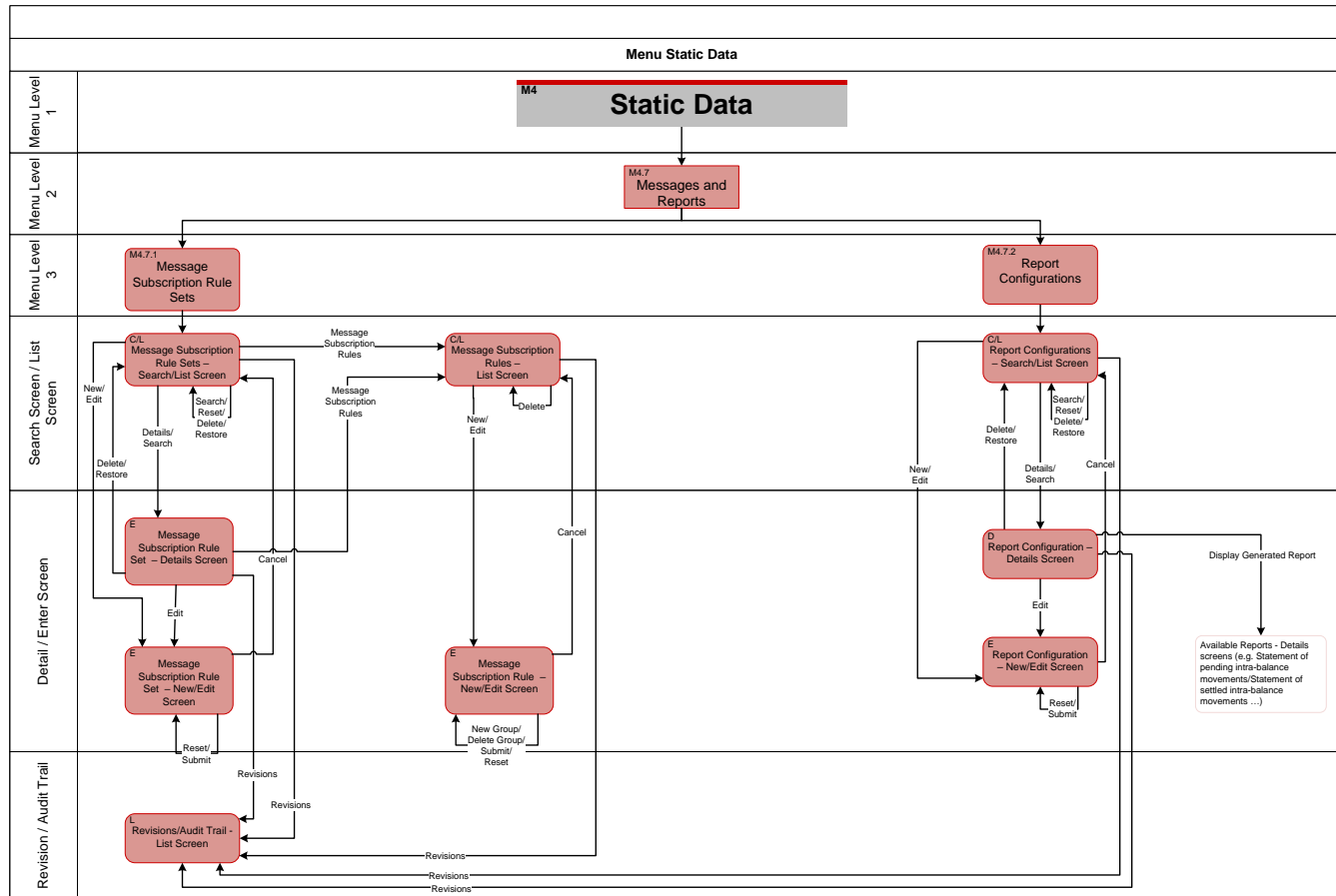

6.3.4.9 Network Configuration

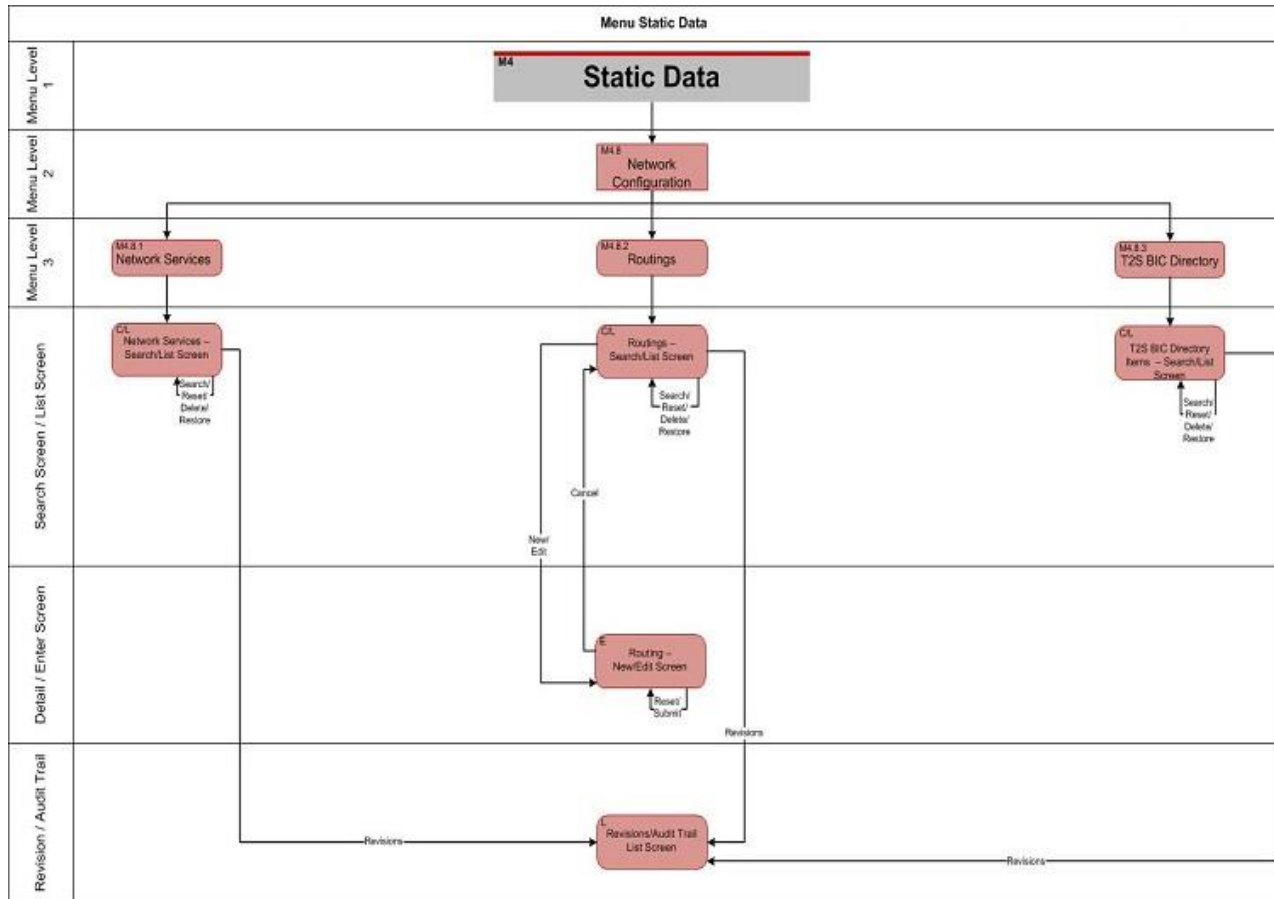

6.3.4.10 Market-Specific Configuration

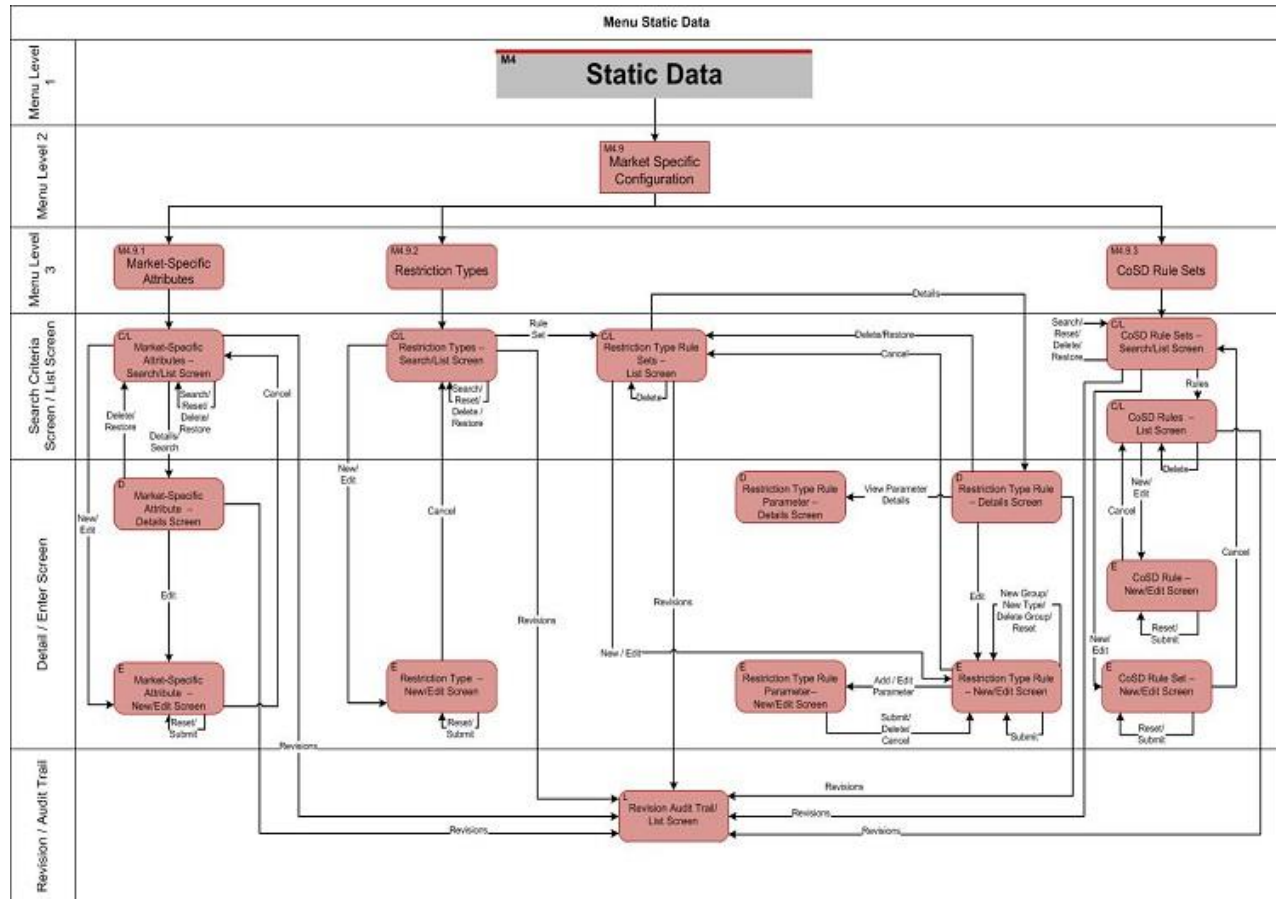

6.3.4.11 General Configuration Parameters

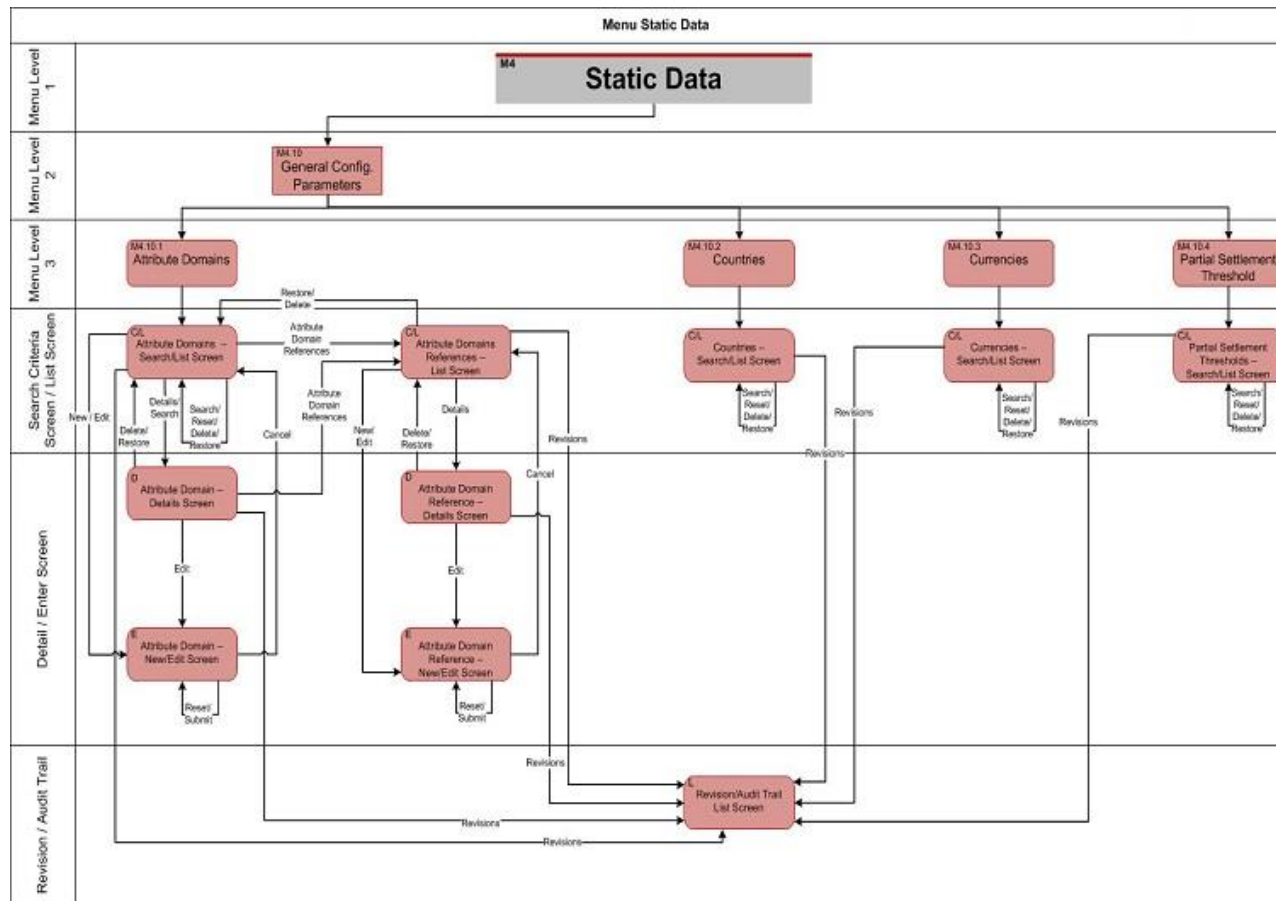

6.3.4.12 General Configuration Parameters II

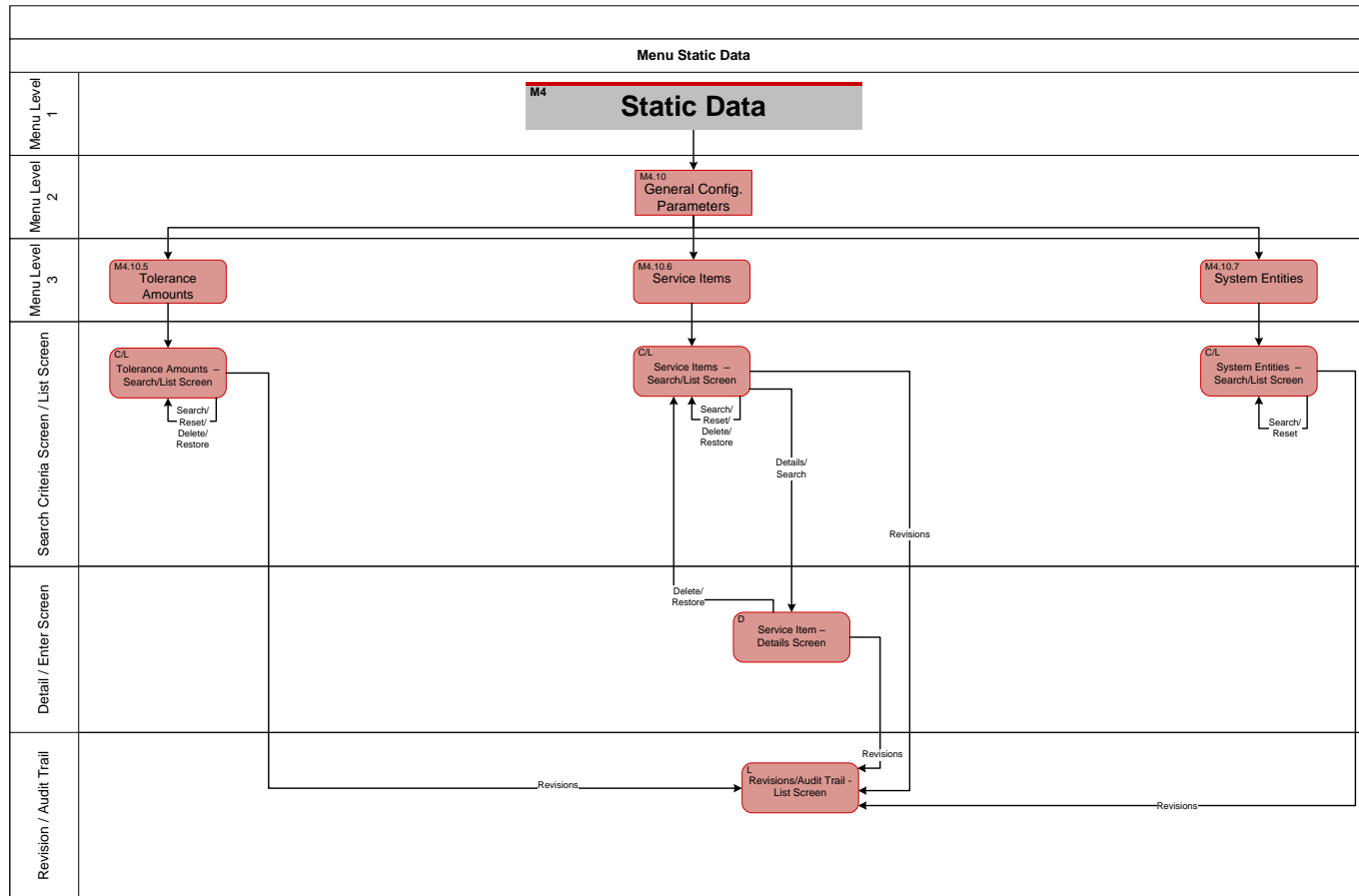

6.3.4.13 Revisions

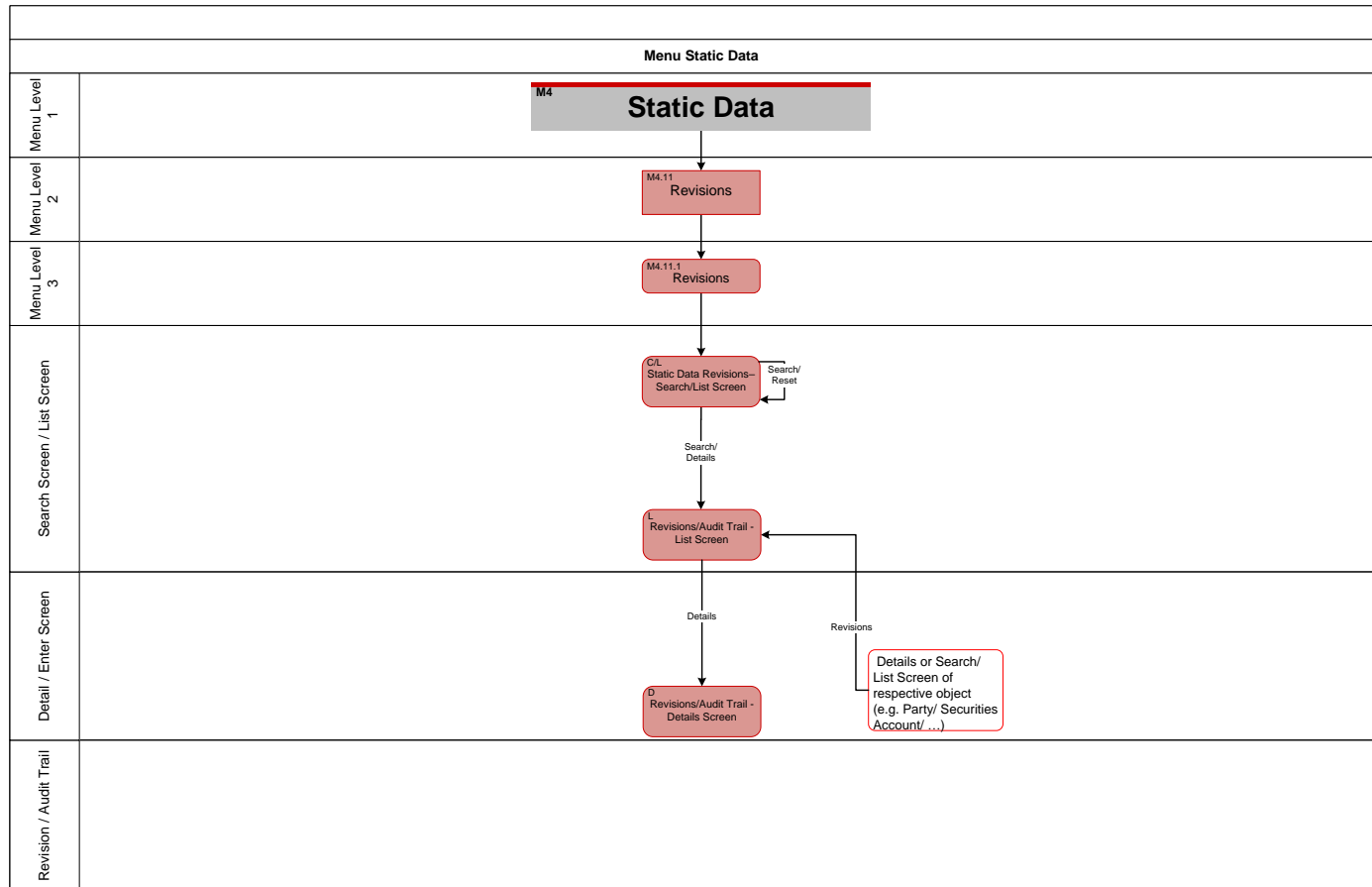

6.3.5 Monitoring

6.3.5.1 Monitoring

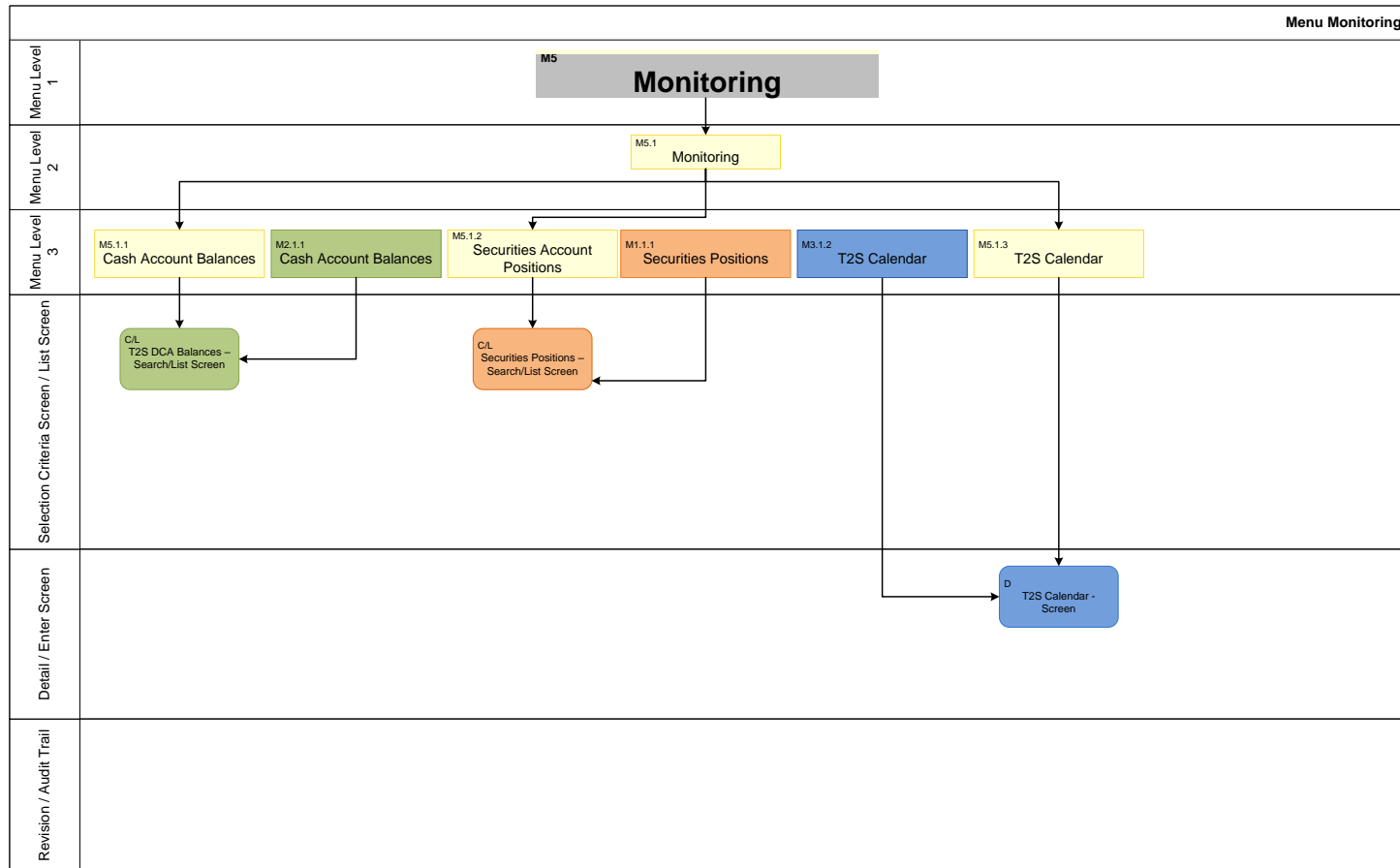

6.3.6 Business Day Management

6.3.6.1 Settlement Day

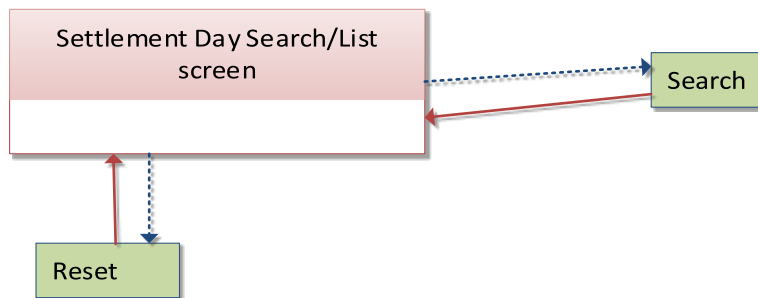

6.3.6.2 Calendar

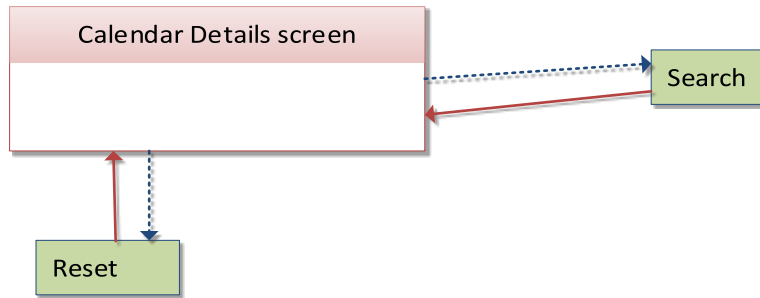

6.4 List of Privileges

6.4.1 Reader's Guide

Reader's Guide

The list of privileges is divided for GUI screens and in LTSI screens. For GUI screens a list of privileges classes is included. Respectively, the list of privileges is structured in accordance with the alphabetical screen order and provides detailed information on privilege code, privilege type, object type and screen criteria related to each privilege.

6.4.2 Privilege Classes for GUI Screens

Class of Privileges	Privilege Name	Privilege Short Name
Access Rights Management	Grant Privilege	ARM_GrantPrivilege
Access Rights Management	Revoke Privilege	ARM_RevokePrivilege
Access Rights Management	Create Role	ARM_CreateRole
Access Rights Management	Update Role	ARM_UpdateRole
Access Rights Management	Delete Role	ARM_DeleteRole
Access Rights Management	Grant/Revoke Role	ARM_GrantRole
Access Rights Management	Create User	ARM_CreateUser
Access Rights Management	Update User	ARM_UpdateUser
Access Rights Management	Delete User	ARM_DeleteUser
Access Rights Management	Create Certificate Distinguish Name	ARM_CreateCertificate DN

Class of Privileges	Privilege Name	Privilege Short Name
Access Rights Management	Delete Certificate Distinguish Name	ARM_DeleteCertificateDN
Access Rights Management	Create User Certificate Distinguish Name Link	ARM_CreateUserCertificateDNLink
Access Rights Management	Delete User Certificate Distinguish Name Link	ARM_DeleteUserCertificateDNLink
Access Rights Management	Create Secured Group	ARM_CreateSecuredGroup
Access Rights Management	Update Secured Group	ARM_UpdateSecuredGroup
Access Rights Management	Delete Secured Group	ARM_DeleteSecuredGroup
Access Rights Management	Administer Party	ARM_AdministerParty
Access Rights Queries	Access Rights Query	ARQ_AccessRightsQuery
Access Rights Queries	Privilege Query	ARQ_PrivilegeQuery
Access Rights Queries	Role List Query	ARQ_RoleListQuery
Access Rights Queries	T2S System User Query (T2S Actor Query)	ARQ_T2SSysUserQueryT2SActorQuery
Access Rights Queries	Certificate Query	ARQ_CertificateDNQuery
Access Rights Queries	T2S System User Link Query	ARQ_UserCertificateDNLinkQuery
Access Rights Queries	Secured Group List Query	ARQ_SecuredGroupListQuery

Class of Privileges	Privilege Name	Privilege Short Name
Access Rights Queries	Secured Group Details Query	ARQ_SecuredGroupDetailsQuery
Access Rights Queries	Granted System Privileges List Query	ARQ_GrantedSysPrivilegesListQuery
Access Rights Queries	Granted Object Privileges List Query	ARQ_GrantObjectPrivilegesListQuery
Access Rights Queries	Granted Roles List Query	ARQ_GrantedRolesListQuery
Billing Queries	Service Item List Query	BIQ_ServiceItemListQuery
Billing Queries	Service Item Details Query	BIQ_ServiceItemDetailsQuery
Billing Queries	Itemised Billing Data List Query	BIQ_ItemisedBillDataListQuery
Billing Queries	Itemised Billing Data Query	BIQ_ItemisedBillDataDetailsQuery
Billing Queries	Cumulative Billing Data List Query	BIQ_CumulativeBillDataListQuery
Billing Queries	Cumulative Billing Data Query	BIQ_CumulativeBillDataDetailsQuery
Cash Management	Amend Process Indicator Settlement Restriction on Cash on a Dedicated Cash Account	CAM_ASRCA
Cash Management	Cancel Settlement Restriction on Cash on a Dedicated Cash Account	CAM_CSRCA
Cash Management	Send New Liquidity Transfer	CAM_Send New Liquidity Transfer
Cash Management	Send New Settlement Restriction on Cash on a Dedicated Cash Account	CAM_SNDRC

Class of Privileges	Privilege Name	Privilege Short Name
Cash Management	Unblock CoSD Cash Blocking related to cancelled CoSD Settlement Instructions on Behalf of the relevant CSD in T2S	CAM_UCBBI
Dynamic Data Queries	Settlement Instruction Query	DDQ_SettlInstructQuery
Dynamic Data Queries	Settlement Instruction Current Status Query	DDQ_SettlInstructCurrentStatusQuery
Dynamic Data Queries	Settlement Instruction Status Audit Trail Query	DDQ_SettlInstructStatusAuditTrailQu
Dynamic Data Queries	Settlement Instruction Audit Trail Query	DDQ_SettlInstructAuditTrailQuery
Dynamic Data Queries	Securities Position Detailed Restriction Details Query	DDQ_SecurPosDetailedRestrDetailsQue
Dynamic Data Queries	Securities Posting Query	DDQ_SecuritiesPostingQuery
Dynamic Data Queries	Securities Account Position Query	DDQ_SecuritiesAccountPositionQuery
Dynamic Data Queries	Maintenance for Intra-Position Movements and Settlement Instructions Query	DDQ_MaintForIntraPosMov+SettlInstrQ
Dynamic Data Queries	Amendment Instruction Query for Intra-Position Movements and Settlement Instructions	DDQ_AmendInstrQIntraPosMov+SetInstr
Dynamic Data Queries	Intra-Position Movements Query	DDQ_IntraPosMovQuery
Dynamic Data Queries	Allegation Query	DDQ_AllegationQuery
Dynamic Data	Inbound Message List Query	DDQ_InboundMessListQuery

Class of Privileges	Privilege Name	Privilege Short Name
Queries		
Dynamic Data Queries	Inbound Message Details Query	DDQ_InboundMessDetailsQuery
Dynamic Data Queries	Outbound Message List Query	DDQ_OutboundMessListQuery
Dynamic Data Queries	Outbound Message Details Query	DDQ_OutboundMessDetailsQuery
Dynamic Data Queries	Inbound Files List Query	DDQ_InboundFilesListQuery
Dynamic Data Queries	Inbound Files Details Query	DDQ_InboundFilesDetailsQuery
Dynamic Data Queries	Outbound Files List Query	DDQ_OutboundFilesListQuery
Dynamic Data Queries	Outbound Files Details Query	DDQ_OutboundFilesDetailsQuery
Dynamic Data Queries	Data Changes of a Business Object List Query	DDQ_DataChan-BusinessObjListQuery
Dynamic Data Queries	Data Changes of a Business Object Details Query	DDQ_DataChan-BusinessObjDetailQuery
Dynamic Data Queries	Intra-Positon Movement Audit Trail List Query	DDQ_IntraPosMovAuditTrailListQuery
Dynamic Data Queries	Intra-Positon Movement Audit Trail Details Query	DDQ_IntraPosMovAuditTrailDetQuery
Dynamic Data Queries	Hold/Release Instruction Audit Trail List Query	DDQ_HoldReleInstrAuditTrailLisQuery
Dynamic Data	Hold/Release Instruction Audit	DDQ_HoldReleInstrAu

Class of Privileges	Privilege Name	Privilege Short Name
Queries	Trail Details Query	ditTrailDetQuery
Dynamic Data Queries	Amendment Instruction for Intra-Position Movement or Settlement Instruction Audit Trail List Query	DDQ_AmdInsIntrPosMovSetInsAudTrLisQ
Dynamic Data Queries	Amendment Instruction for Intra-Position Movement or Settlement Instruction Audit Trail Details Query	DDQ_AmdInsIntrPosMovSetInsAudTrDetQ
Dynamic Data Queries	Cancellation Instruction for Intra-Balance Movement Audit Trail Details Query	DDQ_CancInstrIntraBalanceMovAudTrDetQ
Dynamic Data Queries	Cancellation Instruction for Intra-Balance Movement Audit Trail List Query	DDQ_CancInstrIntraBalanceMovAudTrLisQ
Dynamic Data Queries	Cancellation Instruction for Intra-Position Movement or Settlement Instruction Audit Trail List Query	DDQ_CancInstrIntraPosMovAudTrLisQ
Dynamic Data Queries	Cancellation Instruction for Intra-Position Movement or Settlement Instruction Audit Trail Details Query	DDQ_CancInstrIntraPosMovAudTrDetQ
Dynamic Data Queries	Cancellation Instruction Query for Intra-position Movements and Settlement Instructions	DDQ_CancInstrForSI+IntraPosMovQuery
Dynamic Data Queries	Broadcast Query	DDQ_BroadcastQuery
Dynamic Data Queries	Amendment Instruction for Intra-Balance Movement Audit Trail Details Query	DDQ_AmdInstrForIntraBalMovAudTrDetQ
Dynamic Data Queries	Amendment Instruction for Intra-Balance Movement Audit Trail List Query	DDQ_AmdInstrForIntraBalMovAudTrLisQ

Class of Privileges	Privilege Name	Privilege Short Name
Dynamic Data Queries	Amendment Instruction Query for Intra-Balance Movements	DDQ_AmendInstrQueryForIntraBalanMo
Dynamic Data Queries	Cancellation Instructions for Intra-Balance Movements Query	DDQ_CanclInstrctIntraBalanMovQuery
Dynamic Data Queries	Cash Forecast Query	DDQ_CashForecastQuery
Dynamic Data Queries	Collateral Value of a Security Query	DDQ_CollatValue-of-SecurityQuery
Dynamic Data Queries	Collateral Value per T2S Dedicated Cash Account Query	DDQ_CollatValuePerT2SDCAQuery
Dynamic Data Queries	Immediate Liquidity Transfer Order Audit Trail Details Query	DDQ_ImmedLiquidTransferOrderAuditTrailDetailsQuery
Dynamic Data Queries	Immediate Liquidity Transfer Order Audit Trail List Query	DDQ_ImmedLiquidTransferOrderAuditTrailListQuery
Dynamic Data Queries	Immediate Liquidity Transfer Order Detail Query	DDQ_ImmedLiquidTransferOrderDetailQuery
Dynamic Data Queries	Immediate Liquidity Transfer Order List Query	DDQ_ImmedLiquidTransferOrderListQuery
Dynamic Data Queries	Intra-Balance Movement Audit Trail Detail Query	DDQ_IntraBalanMovAuditTrailDetQuery
Dynamic Data Queries	Intra-Balance Movement Audit Trail List Query	DDQ_IntraBalanMovAuditTrailLisQuery
Dynamic Data Queries	Intra-Balance Movements Query	DDQ_IntraBalanMovQuery
Dynamic Data Queries	Limit Utilisation Journal Query	DDQ_LimitUtilisation

Class of Privileges	Privilege Name	Privilege Short Name
		JournalQuery
Dynamic Data Queries	Limit Utilisation Query	DDQ_LimitUtilisationQuery
Dynamic Data Queries	Maintenance Instruction for Intra-Balance Movements Query	DDQ_MaintInstrForIntraBalanMovQuer
Dynamic Data Queries	Outstanding Auto-Collateralisation Credit Query	DDQ_OutstandAuto-CollCreditQuery
Dynamic Data Queries	T2S Dedicated Cash Account Balance Detailed Restrictions Query	DDQ_T2SDCABalanceDetailedRestrictionsQuery
Dynamic Data Queries	T2S Dedicated Cash Account Balance Query	DDQ_T2SDedicatedCashAccBalanceQuery
Dynamic Data Queries	T2S Dedicated Cash Account Posting Query	DDQ_T2SDedicatedCashAccPostingQuery
Dynamic Data Queries	T2S Overall Liquidity Query	DDQ_T2SOverallLiquidityQuery
Dynamic Data Queries	Total Collateral Value per T2S Dedicated Cash Account Query	DDQ_TotalCollatValuePerT2SDCAQuery
Dynamic Data Queries	Settlement Instruction Matched and Accepted Status Query Privilege	DDQ_SettlInstrctMtchAcceptStsQuery
Market-Specific Configuration	Create Attribute Domain	MSC_CreateAttributeDomain
Market-Specific Configuration	Update Attribute Domain	MSC_UpdateAttributeDomain
Market-Specific Configuration	Delete Attribute Domain	MSC_DeleteAttributeDomain
Market-Specific	Create Attribute Reference	MSC_CreateAttributeR

Class of Privileges	Privilege Name	Privilege Short Name
Configuration		reference
Market-Specific Configuration	Update Attribute Reference	MSC_UpdateAttributeReference
Market-Specific Configuration	Delete Attribute Reference	MSC_DeleteAttributeReference
Market-Specific Configuration	Create Market-Specific Attribute	MSC_CreateMarket-SpecificAttribute
Market-Specific Configuration	Update Market-Specific Attribute	MSC_UpdateMarket-SpecificAttribute
Market-Specific Configuration	Delete Market-Specific Attribute	MSC_DeleteMarket-SpecificAttribute
Market-Specific Configuration	Create Restriction Type	MSC_CreateRestrictionType
Market-Specific Configuration	Update Restriction Type	MSC_UpdateRestrictionType
Market-Specific Configuration	Delete Restriction Type	MSC_DeleteRestrictionType
Market-Specific Configuration	Create Restriction Type Rule	MSC_CreateRestrictionTypeRule
Market-Specific Configuration	Update Restriction Type Rule	MSC_UpdateRestrictionTypeRule
Market-Specific Configuration	Delete Restriction Type Rule	MSC_DeleteRestrictionTypeRule
Market-Specific Configuration	Create Conditional Security Delivery Rule Set	MSC_CreateConditSecurDelivRuleSet
Market-Specific Configuration	Update Conditional Security Delivery Rule Set	MSC_UpdateConditSec

Class of Privileges	Privilege Name	Privilege Short Name
Configuration		urDelivRuleSet
Market-Specific Configuration	Delete Conditional Security Delivery Rule Set	MSC_DeleteConditSecurDelivRuleSet
Market-Specific Configuration	Create Conditional Security Delivery Rule	MSC_CreateConditSecurDelivRule
Market-Specific Configuration	Update Conditional Security Delivery Rule	MSC_UpdateConditSecurDelivRule
Market-Specific Configuration	Delete Conditional Security Delivery Rule	MSC_DeleteConditSecurDelivRule
Message Management	Resend Communication	MMA_Resend Communication
Message Management	Third party receipt	MMA_Third party receipt
Message Subscription	Create Message Subscription Rule Set	MSU_CreateMessSubsRuleSet
Message Subscription	Update Message Subscription Rule Set	MSU_UpdateMessSubscriptionRuleSet
Message Subscription	Delete Message Subscription Rule Set	MSU_DeleteMessSubscriptionRuleSet
Message Subscription	Create Message Subscription Rule	MSU_CreateMessageSubscriptionRule
Message Subscription	Update Message Subscription Rule	MSU_UpdateMessageSubscriptionRule
Message Subscription	Delete Message Subscription Rule	MSU_DeleteMessageSubscriptionRule
Message Subscription	Message Subscription Rule Set List Query	MSQ_MessSubscrRule

Class of Privileges	Privilege Name	Privilege Short Name
Queries		SetListQuery
Message Subscription Queries	Message Subscription Rule List Query	MSQ_MessSubscrRuleListQuery
Message Management	RTGS answer	MMA_RTGS answer
Message Management	New Broadcast	MMA_New Broadcast
Message Subscription Queries	Message Subscription Rule Set Details Query	MSQ_MessSubscrRuleSetDetailQuery
MSA Data Queries	Attribute Domain List Query	MSA_AttributeDomainListQuery
MSA Data Queries	Attribute Domain Details Query	MSA_AttributeDomainDetailsQuery
MSA Data Queries	Market-specific Attribute List Query	MSA_Market-SpecAttributeQuery
MSA Data Queries	Market-specific Attribute Detail Query	MSA_Market-SpecAttributeDetailQuery
MSA Data Queries	Market-specific Restriction List Query	MSA_Market-SpecRestrictListQuery
MSA Data Queries	Conditional Security Delivery Rule Set Query	MSA_ConditSecDeliveryRuleSetQuery
MSA Data Queries	Attribute Reference List Query	MSA_DisplayAttributeDomainRefListQuery
MSA Data Queries	Market-specific Restriction Type Rule Detail Query	MSA_Market-SpecRestrictDetailQuery
MSA Data Queries	Market-specific Restriction Type Rule Set List Query	MSA_MarkSpecRestrTypeRuleSetListQuery
MSA Data Queries	Market-specific Restriction Type Rule Parameter Details Query	MSA_MarkSpecRestrTypeRuleParamDetQuery

Class of Privileges	Privilege Name	Privilege Short Name
MSA Data Queries	Conditional Security Delivery Rule List Query	MSA_ConditSecDelive ryRuleQuery
MSA Data Queries	Attribute Reference Details Query	MSA_DisplayAttribDo m ainRefDetQuery
Network Configuration	Create Routing	NCO_CreateRouting
Network Configuration	Update Routing	NCO_UpdateRouting
Network Configuration	Delete Routing	NCO_DeleteRouting
Network Configuration	Create Technical Address Network Service Link	NCO_CreateTechnAdd ressNetServLink
Network Configuration	Update Technical Address Network Service Link	NCO_UpdateTechnAd d ressNetServLink
Network Configuration	Delete Technical Address Network Service Link	NCO_DeleteTechnAdd ressNetServLink
Network Configuration Queries	T2S BIC Query	NCQ_T2SBICQuery
Network Configuration Queries	Network Service List query	NCQ_NetworkServiceL istquery
Network Configuration Queries	Routing List Query	NCQ_RoutingListQuer y
Network Configuration Queries	Technical Address Network Service Link Details Query	NCQ_DisplayTechAdd ressNetSerLink
Party Data Management	Create Party	PDM_CreateParty
Party Data	Update Party	PDM_UpdateParty

Class of Privileges	Privilege Name	Privilege Short Name
Management		
Party Data Management	Delete Party	PDM_DeleteParty
Party Data Queries	Party Audit Trail Query	PDQ_PartyAudTrailQuery
Party Data Queries	Party Reference Data Query	PDQ_PartyReferDataQuery
Party Data Queries	Party List Query	PDQ_PartyListQuery
Party Data Queries	Restricted Party Query	PDQ_RestrictedPartyQuery
Report Configuration	Create Report Configuration	RCO_CreateReportConfiguration
Report Configuration	Update Report Configuration	RCO_UpdateReportConfiguration
Report Configuration	Delete Report Configuration	RCO_DeleteReportConfiguration
Report Configuration Queries	Report Configuration Details Query	RCO_ReportConfigDetailQuery
Report Configuration Queries	Report Configuration List Query	RCO_ReportConfigListQuery
Report Queries	Report List Query	RCO_ReportListQuery
Report Queries	Report Details Query	RCO_ReportDetailsQuery
SAC Data Queries	Securities Account List Query	SAQ_SecuritiesAccountListQuery
SAC Data Queries	Securities Account Reference Data Query	SAQ_SecuritiesAccRefDataQuery

Class of Privileges	Privilege Name	Privilege Short Name
SAC Data Queries	Securities Account Audit Trail Query	SAQ_SecuritiesAccAuditTrailQuery
SAC Data Queries	CSD Account Link Query	SAQ_CSDAccountLinkQuery
SAC Data Queries	CMB Securities Account Link List Query	SAQ_DisplayCMBSecAccLinkListQuery
Scheduling Queries	Event Type List Query	SCQ_EventTypeListQuery
Scheduling Queries	Event Type Details Query	SCQ_EventTypeDetailsQuery
Scheduling Queries	Closing Day Query	SCQ_ClosingDayQuery
Scheduling Queries	Current Status of the T2S settlement day	SCQ_CurrStatusOfT2SSettlDay
Scheduling Queries	T2S Calendar Query	SCQ_T2SCalendarQuery
Scheduling Queries	T2S Diary Query	SCQ_T2SDiaryQuery
Securities Account Data Management	Create Securities Account	SAC_CreateSecuritiesAccount
Securities Account Data Management	Update Securities Account	SAC_UpdateSecuritiesAccount
Securities Account Data Management	Delete Securities Account	SAC_DeleteSecuritiesAccount
Securities Account Data Management	Create CSD Account Link	SAC_CreateCSDAccountLink
Securities Account Data Management	Update CSD Account Link	SAC_UpdateCSDAccountLink

Class of Privileges	Privilege Name	Privilege Short Name
Securities Account Data Management	Delete CSD Account Link	SAC_DeleteCSDAccountLink
Securities Account Data Management	Create CMB Securities Account Link	SAC_CreateCMBSecuritiesAccountLink
Securities Account Data Management	Delete CMB Securities Account Link	SAC_DeleteCMBSecuritiesAccountLink
Securities Account Data Management	Update CMB Securities Account Link	SAC_UpdateCMBSecuritiesAccountLink
Security Data Management	Create Security	SDM_CreateSecurity
Security Data Management	Update Security	SDM_UpdateSecurity
Security Data Management	Delete Security	SDM_DeleteSecurity
Security Data Management	Create Security CSD Link	SDM_CreateSecurityCSDLink
Security Data Management	Update Security CSD Link	SDM_UpdateSecurityCSDLink
Security Data Management	Delete Security CSD Link	SDM_DeleteSecurityCSDLink
Security Data Management	Create Eligible Counterpart CSD Link	SDM_CreateEligibleCounterpartCSDLink
Security Data Management	Update Eligible Counterpart CSD Link	SDM_UpdateEligibleCounterpartCSDLink
Security Data Management	Delete Eligible Counterpart CSD Link	SDM_DeleteEligibleCounterpartCSDLink
Security Data Queries	Eligible Counterpart CSD List Query	SEQ_EligibleCounterpartCSDListQuery
Security Data Queries	Eligible Counterpart CSD Details Query	SEQ_EligibleCounterpartCSDDetailsQuery

Class of Privileges	Privilege Name	Privilege Short Name
Security Data Queries	Securities Reference Data Query	SEQ_SecuritiesReferDataQuery
Security Data Queries	Securities Audit Trail Query	SEQ_SecuritiesAudTrailQuery
Security Data Queries	ISIN List Query	SEQ_ISINListQuery
Security Data Queries	Securities Deviating Nominal Query	SEQ_SecuritiesDeviatNominQuery
Security Data Queries	Securities CSD Link Query	SEQ_SecuritiesCSDLinkQuery
Security Data Management	Create Auto-Collateralisation Eligibility Link	SDM_CreateAutoCollEligibilityLink
Security Data Management	Create Close Link	SDM_CreateCloseLink
Security Data Management	Create Securities Valuation	SDM_CreateSecuritiesValuation
Security Data Management	Delete Auto-Collateralisation Eligibility Link	SDM_DeleteAutoCollEligibilityLink
Security Data Management	Delete Close Link	SDM_DeleteCloseLink
Security Data Queries	Auto-Collateralisation Eligibility Links Query	SEQ_AutoCollEligibilityLinksQuery
Security Data Queries	Close Links Query	SEQ_CloseLinksQuery
Security Data Queries	Securities Valuations Query	SEQ_SecuritiesValuationsQuery
Settlement CSD	Unblock CoSD Securities Blocking related to cancelled CoSD Settlement Instructions on Behalf of the relevant CSD in T2S	SIC_USBBI
Settlement CSD	Send Settlement Instruction	SIC_SINMF

Class of Privileges	Privilege Name	Privilege Short Name
	with non-modifiable flag activated	
Settlement CSD	CSD Hold Settlement Instruction either on a Securities Account or on Behalf of the CSD in T2S	SIC_CSDHI
Settlement CSD	Release CSD Hold Settlement Instruction either on a Securities Account or on Behalf of the CSD in T2S	SIC_RCSDH
Settlement CSD	Release CSD Validation Hold Settlement Instruction either on a Securities Account or on Behalf of the CSD in T2S	SIC_RCSDV
Settlement CSD	Release CoSD Hold Settlement Instruction on Behalf of an Administering Party	SIC_RCOSD
Settlement CSD	Amend Process Indicator of a non-modifiable Settlement Instruction on behalf of the Instructing Party of the underlying instruction	SIC_ANMBI
Settlement CSD	Hold Non-modifiable Instructions on behalf of the Instructing party of the Underlying Settlement Instruction	SIC_HNMBI
Settlement CSD	Release Non-modifiable Instructions on behalf of the Instructing party of the Underlying Settlement Instruction	SIC_RNMBI
Settlement CSD	Cancel Non-modifiable Instructions on behalf of the Instructing party of the Underlying Settlement Instruction	SIC_CNMBI
Settlement General	Send New Settlement Instruction/Settlement Restriction on	SIG_SNDSI

Class of Privileges	Privilege Name	Privilege Short Name
	Securities either on a Securities Account or on Behalf of an external CSD	
Settlement General	Send new instruction using a specific Instructing Party	SIG_SIUIP
Settlement General	Link to an Instruction/Pool Reference belonging to a specific Party	SIG_LIPRP
Settlement General	Party Hold Settlement Instruction on a Securities Account or on Behalf of an external CSD	SIG_PTYHI
Settlement General	Release Party Hold Settlement Instruction on a Securities Account or on Behalf of an external CSD	SIG_RPTYH
Settlement General	Amend Process Indicator of a Settlement Instruction/ Settlement Restriction on Securities either on a Securities Account or on Behalf of the CSD in T2S or on Behalf of an external CSD	SIG_AMNPI
Settlement General	Cancel Settlement Instruction / Settlement Restriction on Securities either on a Securities Account or on Behalf of the CSD in T2S, on Behalf on external CSD or on Behalf of an Administering Party	SIG_CANCI
Settlement ISO Codes	Use ISO Transaction Code AUTO (Auto-Collateralisation)	SII_UAUTO
Settlement ISO Codes	Use ISO Transaction Code BIYI (BuyIn)	SII_UBIYI
Settlement ISO Codes	Use ISO Transaction Code BSBK (Buy Sell Back)	SII_UBSBK

Class of Privileges	Privilege Name	Privilege Short Name
Settlement ISO Codes	Use ISO Transaction Code CLAI (Market Claim)	SII_UCLAI
Settlement ISO Codes	Use ISO Transaction Code CNCB (Central Bank Collateral Operation)	SII_UCNCB
Settlement ISO Codes	Use ISO Transaction Code COLI (Collateral In)	SII_UCOLI
Settlement ISO Codes	Use ISO Transaction Code COLO (Collateral Out)	SII_UCOLO
Settlement ISO Codes	Use ISO Transaction Code CONV (Depository Receipt Conversion)	SII_UCONV
Settlement ISO Codes	Use ISO Transaction Code CORP (Corporate Action)	SII_UCORP
Settlement ISO Codes	Use ISO Transaction Code ETFT	SII_UETFT
Settlement ISO Codes	Use ISO Transaction Code FCTA (Factor Update)	SII_UFCTA
Settlement ISO Codes	Use ISO Transaction Code INSP (Move Of Stock)	SII_UINSP
Settlement ISO Codes	Use ISO Transaction Code ISSU (Issuance)	SII_UISSU
Settlement ISO Codes	Use ISO Transaction Code MKDW (Mark Down)	SII_UMKDW
Settlement ISO Codes	Use ISO Transaction Code MKUP (Mark Up)	SII_UMKUP
Settlement ISO Codes	Use ISO Transaction Code NETT (Netting)	SII_UNETT
Settlement ISO Codes	Use ISO Transaction Code NSYN (Non Syndicated)	SII_UNSYN
Settlement ISO	Use ISO Transaction Code	SII_UOWNI

Class of Privileges	Privilege Name	Privilege Short Name
Codes	OWNI (Internal Account Transfer)	
Settlement ISO Codes	Use ISO Transaction Code PAIR (Pair Off)	SII_UPAIR
Settlement ISO Codes	Use ISO Transaction Code PLAC (Placement)	SII_UPLAC
Settlement ISO Codes	Use ISO Transaction Code PORT (Portfolio Move)	SII_UPORT
Settlement ISO Codes	Use ISO Transaction Code REAL (Realignment)	SII_UREAL
Settlement ISO Codes	Use ISO Transaction Code REDI (Withdrawal)	SII_URED1
Settlement ISO Codes	Use ISO Transaction Code REDM (Redemption)	SII_URED1
Settlement ISO Codes	Use ISO Transaction Code RELE (Depository Receipt Release Cancellation)	SII_URELE
Settlement ISO Codes	Use ISO Transaction Code REPU (Repo)	SII_UREPU
Settlement ISO Codes	Use ISO Transaction Code RVPO (Reverse Repo)	SII_URVPO
Settlement ISO Codes	Use ISO Transaction Code OWNE (External Account Transfer)	SII_UOWNE
Settlement ISO Codes	Use ISO Transaction Code RODE (Return Delivery Without Matching)	SII_URODE
Settlement ISO Codes	Use ISO Transaction Code SBBK (Sell Buy Back)	SII_USBBK
Settlement ISO Codes	Use ISO Transaction Code SBRE (Borrowing Reallocation)	SII_USBRE

Class of Privileges	Privilege Name	Privilege Short Name
Settlement ISO Codes	Use ISO Transaction Code SECB (Securities Borrowing)	SII_USECB
Settlement ISO Codes	Use ISO Transaction Code SECL (Securities Lending)	SII_USECL
Settlement ISO Codes	Use ISO Transaction Code SLRE (Lending Reallocation)	SII_USLRE
Settlement ISO Codes	Use ISO Transaction Code SUBS (Subscription)	SII_USUBS
Settlement ISO Codes	Use ISO Transaction Code SYND (Syndicate Underwriters)	SII_USYND
Settlement ISO Codes	Use ISO Transaction Code TBAC (TBA Closing)	SII_UTBAC
Settlement ISO Codes	Use ISO Transaction Code TRAD (Trade)	SII_UTRAD
Settlement ISO Codes	Use ISO Transaction Code TRPO (Triparty Repo)	SII_UTRPO
Settlement ISO Codes	Use ISO Transaction Code TRVO (Triparty Reverse Repo)	SII_UTRVO
Settlement ISO Codes	Use ISO Transaction Code TURN (Turnaround)	SII_UTURN
Static Data Queries	Partial Settlement Threshold Query	SDQ_PartialSettlThresholdQuery
Static Data Queries	Country Query	SDQ_CountryQuery
Static Data Queries	Currency Query	SDQ_CurrencyQuery
Static Data Queries	Tolerance Amount Query	SDQ_ToleranceAmountQuery
Static Data Queries	Liquidity Transfer Order of Liquidity Transfer Order Link Set Query	SDQ_LiqTranOrdOfLiqTranOrdLinkSetQ
Static Data Queries	Residual Static Data Audit	SDQ_ResidualStaticD

Class of Privileges	Privilege Name	Privilege Short Name
	Trail Query	a taAudTrailQuery
Static Data Queries	System Entity Query	SDQ_SystemEntityQu e ry
T2S Dedicated Cash Account Data	Create Credit Memorandum Balance	DCA_CreateCreditMe m orandumBalance
T2S Dedicated Cash Account Data	Create External RTGS Account	DCA_CreateExternalR TGSAccount
T2S Dedicated Cash Account Data	Create Limit	DCA_CreateLimit
T2S Dedicated Cash Account Data	Create Liquidity Transfer Order	DCA_CreateLiquidityTr ansferOrder
T2S Dedicated Cash Account Data	Create Liquidity Transfer Order Link Set	DCA_CreateLiquidityTr anOrderLinkSet
T2S Dedicated Cash Account Data	Create T2S Dedicated Cash Account	DCA_CreateT2SDedic a tedCashAccount
T2S Dedicated Cash Account Data	Delete Credit Memorandum Balance	DCA_DeleteCreditMe m orandumBalance
T2S Dedicated Cash Account Data	Delete External RTGS Account	DCA_DeleteExternalR T GSAccount
T2S Dedicated Cash Account Data	Delete Limit	DCA_DeleteLimit
T2S Dedicated Cash Account Data	Delete Liquidity Transfer Order	DCA_DeleteLiquidityTr ansferOrder
T2S Dedicated Cash Account Data	Delete Liquidity Transfer Order Link Set	DCA_DeleteLiquidityTr anOrderLinkSet
T2S Dedicated Cash Account Data	Delete T2S Dedicated Cash Account	DCA_DeleteT2SDedic a tedCashAccount

Class of Privileges	Privilege Name	Privilege Short Name
T2S Dedicated Cash Account Data	Update Credit Memorandum Balance	DCA_UpdateCreditMemorandumBalance
T2S Dedicated Cash Account Data	Update External RTGS Account	DCA_UpdateExternalRTGSAccount
T2S Dedicated Cash Account Data	Update Limit	DCA_UpdateLimit
T2S Dedicated Cash Account Data	Update Liquidity Transfer Order	DCA_UpdateLiquidityTransferOrder
T2S Dedicated Cash Account Data	Update Liquidity Transfer Order Link Set	DCA_UpdateLiquidityTransferOrderLinkSet
T2S Dedicated Cash Account Data	Update T2S Dedicated Cash Account	DCA_UpdateT2SDedicatedCashAccount
T2S Dedicated Cash Account Data Queries	CMB Details Query	DCQ_CMBDetailsQuery
T2S Dedicated Cash Account Data Queries	CMB List Query	DCQ_CMBListQuery
T2S Dedicated Cash Account Data Queries	External RTGS Account Details Query	DCQ_ExtRTGSAccountDetailsQuery
T2S Dedicated Cash Account Data Queries	External RTGS Account List Query	DCQ_ExtRTGSAccountListQuery
T2S Dedicated Cash Account Data Queries	Limit Query	DCQ_LimitQuery
T2S Dedicated Cash Account Data Queries	Liquidity Transfer Order Detail Query	DCQ_LiquidTransferOrderDetailQuery
T2S Dedicated Cash Account Data Queries	Liquidity Transfer Order Link Set Query	DCQ_LiquidTransferOrderLinkSetQuery
T2S Dedicated Cash Account Data Queries	Liquidity Transfer Order List Query	DCQ_LiquidTransferOrderListQuery
T2S Dedicated Cash	T2S Dedicated Cash Account	DCQ_T2SDedicCashA

Class of Privileges	Privilege Name	Privilege Short Name
Account Data Queries	Audit Trail Query	ccAudTrailQuery
T2S Dedicated Cash Account Data Queries	T2S Dedicated Cash Account List Query	DCQ_T2SDedicatedCashAccListQuery
T2S Dedicated Cash Account Data Queries	T2S Dedicated Cash Account Reference Data Query	DCQ_T2SDedicCashAccReferDataQuery
T2S Dedicated Cash Account Data Queries	Total amount of standing and predefined orders Query	DCQ_TotAmountStandingPredefOrdQuery

6.4.3 Privileges for GUI Screens

6.4.3.1 Allegement Instruction - Details Screen

△ [▶ **Error! Bookmark not defined.**]

No privileges.

6.4.3.2 Allegement Instructions - Search/List Screen

△ [▶ **Error! Bookmark not defined.**]

Privilege	Privilege Code	Privilege Type	Object Types	Screen Criteria
Allegation Query	DDQ_Allegment Query	Object	Party	n/a

6.4.3.3 Amendment Cash Instruction - Details Screen

△ [▶ **Error! Bookmark not defined.**]

Privilege	Privilege Code	Privilege Type	Object Types	Screen Criteria
Amendment Instruction for Intra-Balance Movement Audit Trail List Query	DDQ_AmendmentInstrForIntraBalanceMovementAuditTrailListQuery	Object	T2S Dedicated Cash Account (analog Amendment Instruction Query for Intra Balance	n/a

Privilege	Privilege Code	Privilege Type	Object Types	Screen Criteria
			Movements)	

6.4.3.4 Amendment Cash Instruction - New Screen

△ [▶ **Error! Bookmark not defined.**]

Privilege	Privilege Code	Privilege Type	Object Types	Screen Criteria
Link to an Instruction / Pool Reference belonging to a specific Party	SIG_LIP RP	Object	Party	Actor Reference or T2S Reference in Linkages block
Amend Process Indicator Settlement Restriction on Cash on a Dedicated Cash Account	CAM_AS RCA	Object	T2S Dedicated Cash Account	T2S Dedicated Cash Account Number
Send new instruction using a specific Instructing Party	SIG_SIU IP	Object	Party	n/a

6.4.3.5 Amendment Securities Instruction - Details Screen

△ [▶ **Error! Bookmark not defined.**]

Privilege	Privilege Code	Privilege Type	Object Types	Screen Criteria
Amendment Instruction for Intra-Position Movement or Settlement Instruction Audit Trail List Query	DDQ_Am dInsIntrP osMovSet InsAud TrLisQ	Object	Securities Account	n/a

6.4.3.6 Amendment Securities Instruction - New Screen

△ [▶ **Error! Bookmark not defined.**]

Privilege	Privilege Code	Privilege Type	Object Types	Screen Criteria
Send new instruction using a specific Instructing Party	SIG_SIU IP	Object	Party	n/a
Link to an Instruction / Pool Reference belonging to a specific Party	SIG_LIP RP	Object	Party	Actor Reference or T2S Reference in Linkages block
Amend Process Indicator of a Settlement Instruction/Settlement Restriction on Securities either on a Securities Account or on Behalf of the CSD in T2S or on Behalf of an external CSD	SIG_AM NPI	Object	Party Securities Account	n/a
Amend Process Indicator of a non-modifiable Settlement Instruction on behalf of the Instructing Party of the underlying instruction	SIC_AN MBI	Object	Party	n/a

6.4.3.7 Attribute Domain - Details Screen

△ [▶ **Error! Bookmark not defined.**]

Privilege	Privilege Code	Privilege Type	Object Types	Screen Criteria
Delete Attribute Domain	MSC_ Delete Attribute Domain	System	n/a	Delete button
Attribute Domain Details Query	MSA_ Attribute Domain Details Query	System	n/a	n/a

6.4.3.8 Attribute Domain - New/Edit Screen

△ [▶ **Error! Bookmark not defined.**]

Privilege	Privilege Code	Privilege Type	Object Types	Screen Criteria
Create Attribute Domain	MSC_CreateAttributeDomain	System	n/a	New mode
Update Attribute Domain	MSC_UpdateAttributeDomain	System	n/a	Edit mode

6.4.3.9 Attribute Domain Reference - Details Screen

△ [▶ **Error! Bookmark not defined.**]

Privilege	Privilege Code	Privilege Type	Object Types	Screen Criteria
Delete Attribute Reference	MSC_DeleteAttributeReference	System	n/a	Delete button
Attribute Reference Details Query	MSA_DisplayAttributeDomainRefDetQuery	System	n/a	n/a

6.4.3.10 Attribute Domain Reference - New/Edit Screen

△ [▶ **Error! Bookmark not defined.**]

Privilege	Privilege Code	Privilege Type	Object Types	Screen Criteria
Create Attribute Reference	MSC_CreateAttributeReference	System	n/a	New mode
Update Attribute Reference	MSC_UpdateAttributeReference	System	n/a	Edit mode

6.4.3.11 Attribute Domain References - List Screen

△ [▶ **Error! Bookmark not defined.**]

Privilege	Privilege Code	Privilege Type	Object Types	Screen Criteria
Delete Attribute Reference	MSC_DeleteAttributeReference	System	n/a	Delete button
Attribute Reference List Query	MSA_DisplayAttributeDomainRefListQuery	System	n/a	n/a

6.4.3.12 Attribute Domains - Search/List Screen

△ [▶ **Error! Bookmark not defined.**]

Privilege	Privilege Code	Privilege Type	Object Types	Screen Criteria
Delete Attribute Domain	MSC_DeleteAttributeDomain	System	n/a	Delete button
Attribute Domain List Query	MSA_Attribute	System	n/a	n/a

Privilege	Privilege Code	Privilege Type	Object Types	Screen Criteria
	Domain ListQuery			

6.4.3.13 Auto-Collateralisation Eligibility Link - New Screen

△ [▶ Error! Bookmark not defined.]

Privilege	Privilege Code	Privilege Type	Object Types	Screen Criteria
Create Auto-Collateralisation Eligibility Link	SDM_ Create Auto-Coll Eligibility Link	System	n/a	New mode

6.4.3.14 Auto-Collateralisation Eligibility Links - Search/List Screen

△ [▶ Error! Bookmark not defined.]

Privilege	Privilege Code	Privilege Type	Object Types	Screen Criteria
Auto-Collateralisation Eligibility Links Query	SEQ_ Auto-Coll Eligibility LinksQuery	System	n/a	n/a
Delete Auto-Collateralisation Eligibility Link	SDM_ Delete Auto-Coll Eligibility Link	System	n/a	Delete button

6.4.3.15 Available Report - Current Settlement Day Cash Information (Following Settlement Day Cash Forecast) Report - Details Screen

△ [▶ Error! Bookmark not defined.]

Privilege	Privilege Code	Privilege Type	Object Types	Screen Criteria
Report Details Query	RCO_ Report Details Query	System	n/a	n/a

6.4.3.16 Available Report - Details Screen

△ [▶ **Error! Bookmark not defined.**]

Privilege	Privilege Code	Privilege Type	Object Types	Screen Criteria
Report Details Query	RCO_ Report Details Query	System	n/a	n/a
Report List Query	RCO_ Report ListQuery	System	n/a	n/a

6.4.3.17 Available Report - Statement of Accounts - Details Screen

△ [▶ **Error! Bookmark not defined.**]

Privilege	Privilege Code	Privilege Type	Object Types	Screen Criteria
Report Details Query	RCO_ Report Details Query	System	n/a	n/a

6.4.3.18 Available Report - Statement of Executed Amendment Instructions for Intra-Balance Movements - Details Screen

△ [▶ **Error! Bookmark not defined.**]

Available Report - Statement of Executed Amendment Instructions for Intra-Position Movements
and Settlement Instructions - Details Screen

Privilege	Privilege Code	Privilege Type	Object Types	Screen Criteria
Report Details Query	RCO_ Report Details Query	System	n/a	n/a

6.4.3.19 Available Report - Statement of Executed Amendment Instructions for Intra-Position Movements and Settlement Instructions - Details Screen

△ [▶ **Error! Bookmark not defined.**]

Privilege	Privilege Code	Privilege Type	Object Types	Screen Criteria
Report Details Query	RCO_ Report Details Query	System	n/a	n/a

6.4.3.20 Available Report - Statement of Executed Cancellation Instructions for Intra-Balance Movements - Details Screen

△ [▶ **Error! Bookmark not defined.**]

Privilege	Privilege Code	Privilege Type	Object Types	Screen Criteria
Report Details Query	RCO_ Report Details Query	System	n/a	n/a

6.4.3.21 Available Report - Statement of Executed Cancellation Instructions for Intra-Position Movements and Settlement Instructions - Details Screen

△ [▶ **Error! Bookmark not defined.**]

Privilege	Privilege Code	Privilege Type	Object Types	Screen Criteria
Report Details Query	RCO_ Report Details Query	System	n/a	n/a

6.4.3.22 Available Report - Statement of Holdings - Details Screen

△ [▶ **Error! Bookmark not defined.**]

Privilege	Privilege Code	Privilege Type	Object Types	Screen Criteria
Report Details Query	RCO_ Report Details Query	System	n/a	n/a

6.4.3.23 Available Report - Statement of Pending Amendment Instructions for Intra-Balance Movements - Details Screen

△ [▶ **Error! Bookmark not defined.**]

Privilege	Privilege Code	Privilege Type	Object Types	Screen Criteria
Report Details Query	RCO_ Report Details Query	System	n/a	n/a

6.4.3.24 Available Report - Statement of Pending Amendment Instructions for Intra-Position Movements and Settlement Instructions - Details Screen

△ [▶ **Error! Bookmark not defined.**]

Privilege	Privilege Code	Privilege Type	Object Types	Screen Criteria
Report Details Query	RCO_ Report Details Query	System	n/a	n/a

6.4.3.25 Available Report - Statement of Pending Cancellation Instructions for Intra-Balance Movements - Details Screen

△ [▶ **Error! Bookmark not defined.**]

Privilege	Privilege Code	Privilege Type	Object Types	Screen Criteria
Report Details Query	RCO_ Report Details Query	System	n/a	n/a

6.4.3.26 Available Report - Statement of Pending Cancellation Instructions for Intra-Position Movements and Settlement Instructions - Details Screen

△ [▶ **Error! Bookmark not defined.**]

Privilege	Privilege Code	Privilege Type	Object Types	Screen Criteria
Report Details Query	RCO_ Report Details Query	System	n/a	n/a

6.4.3.27 Available Report - Statement of Pending Instructions - Details Screen

△ [▶ **Error! Bookmark not defined.**]

Available Report - Statement of Pending Intra-Balance Movements - Details Screen

Privilege	Privilege Code	Privilege Type	Object Types	Screen Criteria
Report Details Query	RCO_Report Details Query	System	n/a	n/a

6.4.3.28 Available Report - Statement of Pending Intra-Balance Movements - Details Screen

△ [▶ **Error! Bookmark not defined.**]

Privilege	Privilege Code	Privilege Type	Object Types	Screen Criteria
Report Details Query	RCO_Report Details Query	System	n/a	n/a

6.4.3.29 Available Report - Statement of Pending Intra-Position Movements - Details Screen

△ [▶ **Error! Bookmark not defined.**]

Privilege	Privilege Code	Privilege Type	Object Types	Screen Criteria
Report Details Query	RCO_Report Details Query	System	n/a	n/a

6.4.3.30 Available Report - Statement of Settled Intra-Balance Movements - Details Screen

△ [▶ **Error! Bookmark not defined.**]

Privilege	Privilege Code	Privilege Type	Object Types	Screen Criteria
Report Details Query	RCO_Report	System	n/a	n/a

Privilege	Privilege Code	Privilege Type	Object Types	Screen Criteria
	Details Query			

6.4.3.31 Available Report - Statement of Settled Intra-Position Movements - Details Screen

△ [▶ Error! Bookmark not defined.]

Privilege	Privilege Code	Privilege Type	Object Types	Screen Criteria
Report Details Query	RCO_Report Details Query	System	n/a	n/a

6.4.3.32 Available Report - Statement of Settlement Allegements - Details Screen

△ [▶ Error! Bookmark not defined.]

Privilege	Privilege Code	Privilege Type	Object Types	Screen Criteria
Report Details Query	RCO_Report Details Query	System	n/a	n/a

6.4.3.33 Available Report - Statement of Static Data - Details Screen

△ [▶ Error! Bookmark not defined.]

Privilege	Privilege Code	Privilege Type	Object Types	Screen Criteria
Report Details Query	RCO_Report Details Query	System	n/a	n/a

6.4.3.34 Available Report - Statement of Transactions - Details Screen

△ [▶ Error! Bookmark not defined.]

Privilege	Privilege Code	Privilege Type	Object Types	Screen Criteria
Report Details Query	RCO_ Report Details Query	System	n/a	n/a

6.4.3.35 Available Reports - Search/List Screen

△ [▶ 41]

Privilege	Privilege Code	Privilege Type	Object Types	Screen Criteria
Report List Query	RCO_ Report ListQuery	System	n/a	n/a

6.4.3.36 Broadcast - Details Screen

△ [▶ Error! Bookmark not defined.]

Privilege	Privilege Code	Privilege Type	Object Types	Screen Criteria
Broadcast Query	DDQ_ Broadca stQuery	System	n/a	n/a

6.4.3.37 Broadcast - New Screen

△ [▶ Error! Bookmark not defined.]

Privilege	Privilege Code	Privilege Type	Object Types	Screen Criteria
New Broadcast	MMA_ New Broad	System	n/a	n/a

Privilege	Privilege Code	Privilege Type	Object Types	Screen Criteria
	cast			

6.4.3.38 Broadcasts - Search/List Screen

△ [▶ 50]

Privilege	Privilege Code	Privilege Type	Object Types	Screen Criteria
Broadcast Query	DDQ_ Broadca stQuery	System	n/a	n/a
New Broadcast	MMA_ New Broad cast	System	n/a	n/a

6.4.3.39 Cancellation Cash Instruction - Details Screen

△ [▶ **Error! Bookmark not defined.**]

Privilege	Privilege Code	Privilege Type	Object Types	Screen Criteria
Cancellation Instruction for Intra-Balance Movement Audit Trail Details Query	DDQ_ Canclnstr IntraBala nMovAud TrDetQ	Object	T2S Dedicat- ed Cash Ac- count (analog Cancellation Instructions for Intra Bal- ance Move- ments Query)	Transactional Data Object Type

6.4.3.40 Cancellation Cash Instruction - New Screen

△ [▶ **Error! Bookmark not defined.**]

Privilege	Privilege Code	Privilege Type	Object Types	Screen Criteria
Send new instruction using a specific Instructing Party	SIG_SIU IP	Object	Party	n/a
Cancel Settlement Restriction on Cash on a Dedicated Cash Account	CAM_CS RCA	Object	T2S Dedicated Cash Account	T2S Dedicated Cash Account

6.4.3.41 Cancellation Securities Instruction - Details Screen

△ [▶ **Error! Bookmark not defined.**]

Privilege	Privilege Code	Privilege Type	Object Types	Screen Criteria
Cancellation Instruction for Intra-Position Movement or Settlement Instruction Audit Trail List Query	DDQ_ Canclnst rIntraPo sMovAud TrLisQ	Object	Securities Account	n/a

6.4.3.42 Cancellation Securities Instruction - New Screen

△ [▶ **Error! Bookmark not defined.**]

Privilege	Privilege Code	Privilege Type	Object Types	Screen Criteria
Send new instruction using a specific Instructing Party	SIG_SIU IP	Object	Party	n/a
Cancel Settlement Instruction / Settlement Restriction on Securities either on a Securities Account or on Behalf of the CSD in T2S, on Behalf on external CSD or on Behalf of an Administering Party	SIG_CA NCI	Object	Party Securities Account	n/a
Cancel Non-modifiable Instructions on behalf of the Instructing party of the Underlying Settlement Instruction	SIC_CN MBI	Object	Party	n/a

6.4.3.43 Calendar

△ [▶ 47]

Privilege	Privilege Code	Privilege Type	Object Types	Screen Criteria
T2S Calendar Query	SCQ_ T2SCalen darQuery	System	n/a	n/a

6.4.3.44 Cash Discount Penalty Rate - Search/List Screen

△ [▶ **Error! Bookmark not defined.**]

Privilege	Privilege Code	Privilege Type	Object Types	Screen Criteria
Cash Discount	SPQ_CashDisc	System	n/a	n/a{CR-654}

Privilege	Privilege Code	Privilege Type	Object Types	Screen Criteria
<u>Penalty Rate Query</u>	<u>ountPenaltyRateQuery</u>			

6.4.3.45 Cash Forecast - Details Screen

△ [▶ **Error! Bookmark not defined.**]

No privileges.

6.4.3.46 Cash Forecasts - Search/List Screen

△ [▶ **Error! Bookmark not defined.**]

Privilege	Privilege Code	Privilege Type	Object Types	Screen Criteria
Cash Forecast Query	DDQ_Cash Forecast Query	Object	Party	n/a

6.4.3.47 Cash Restriction Details - Search/List Screen

△ [▶ **Error! Bookmark not defined.**]

Privilege	Privilege Code	Privilege Type	Object Types	Screen Criteria
T2S Dedicated Cash Account Balance Detailed Restrictions Query	DDQ_T2SDCABalanced Restriction Query	Object	T2S Dedicated Cash Account	n/a

6.4.3.48 Certificate Distinguished Name - New Screen

△ [▶ **Error! Bookmark not defined.**]

Privilege	Privilege Code	Privilege Type	Object Types	Screen Criteria
Create Certificate Dis-	ARM_	System	n/a	New mode

Privilege	Privilege Code	Privilege Type	Object Types	Screen Criteria
tinguish Name	Create CertificateDN			

6.4.3.49 Certificates Distinguished Names - Search/List Screen

△ [▶ **Error! Bookmark not defined.**]

Privilege	Privilege Code	Privilege Type	Object Types	Screen Criteria
Certificate Query	ARQ_CertificateDNQuery	System	n/a	n/a
Delete Certificate Distinguish Name	ARM_DeleteCertificateDN	System	n/a	Delete button

6.4.3.50 Close Link – New Screen

△ [▶ **Error! Bookmark not defined.**]

Privilege	Privilege Code	Privilege Type	Object Types	Screen Criteria
Create Close Link	SDM_CreateCloseLink	System	n/a	New mode

6.4.3.51 Close Links - Search/List Screen

△ [▶ **Error! Bookmark not defined.**]

Privilege	Privilege Code	Privilege Type	Object Types	Screen Criteria
Close Links Query	SEQ_ CloseLinksQuery	System	n/a	n/a
Delete Close Link	SDM_ DeleteCloseLink	System	n/a	Delete button

6.4.3.52 CMB - Details Screen

△ [▶ Error! Bookmark not defined.]

Privilege	Privilege Code	Privilege Type	Object Types	Screen Criteria
Delete Credit Memorandum Balance	DCA_ DeleteCreditMemorandumBalance	System	n/a	Delete button
CMB Details Query	DCQ_ CMBDetailsQuery	System	n/a	n/a

6.4.3.53 CMB - New/Edit Screen

△ [▶ Error! Bookmark not defined.]

Privilege	Privilege Code	Privilege Type	Object Types	Screen Criteria
Create Credit Memorandum Balance	DCA_ CreateCreditMemorandumBalance	System	n/a	New mode
Update Credit Memorandum Balance	DCA_ Update	System	n/a	Edit mode

Privilege	Privilege Code	Privilege Type	Object Types	Screen Criteria
	Credit Memorandum Balance			

6.4.3.54 CMBs - Search/List Screen

△ [▶ **Error! Bookmark not defined.**]

Privilege	Privilege Code	Privilege Type	Object Types	Screen Criteria
CMB List Query	DCQ_CMBList Query	System	n/a	n/a
Delete Credit Memorandum Balance	DCA_Delete Credit Memorandum Balance	System	n/a	Delete button

6.4.3.55 Collateral Value of a Security - Search/List Screen

△ [▶ **Error! Bookmark not defined.**]

Privilege	Privilege Code	Privilege Type	Object Types	Screen Criteria
Collateral Value of a Security Query	DDQ_Collat Value-of-Security Query	System	n/a	n/a

6.4.3.56 Collateral Value per T2S Dedicated Cash Account and Security - Search/List Screen

△ [▶ **Error! Bookmark not defined.**]

Privilege	Privilege Code	Privilege Type	Object Types	Screen Criteria
Collateral Value per T2S Dedicated Cash Account Query	DDQ_CollatValuePerT2SDCAQuery	System	n/a	n/a

6.4.3.57 CoSD Rule - New/Edit Screen

△ [▶ Error! Bookmark not defined.]

Privilege	Privilege Code	Privilege Type	Object Types	Screen Criteria
Create Conditional Security Delivery Rule	MSC_CreateConditSecurDelivRule	System	n/a	New mode
Update Conditional Security Delivery Rule	MSC_UpdateConditSecurDelivRule	System	n/a	Edit mode

6.4.3.58 CoSD Rule Set - New/Edit Screen

△ [▶ Error! Bookmark not defined.]

Privilege	Privilege Code	Privilege Type	Object Types	Screen Criteria
Create Conditional Security Delivery Rule Set	MSC_CreateConditSecurDelivRuleSet	System	n/a	New mode
Update Conditional Security Delivery Rule Set	MSC_UpdateConditSecurDeliv	System	n/a	Edit mode

Privilege	Privilege Code	Privilege Type	Object Types	Screen Criteria
	RuleSet			

6.4.3.59 CoSD Rule Sets - Search/List Screen

△ [▶ **Error! Bookmark not defined.**]

Privilege	Privilege Code	Privilege Type	Object Types	Screen Criteria
Conditional Security Delivery Rule Set Query	MSA_ ConditSe cDelivery RuleSet Query	System	n/a	n/a
Delete Conditional Security Delivery Rule Set	MSC_ DeleteCo nditSecur Deliv RuleSet	System	n/a	Delete button
Conditional Security Delivery Rule Set Query	MSA_ ConditSe cDelivery RuleSet Query	System	n/a	n/a

6.4.3.60 CoSD Rules - List Screen

△ [▶ **Error! Bookmark not defined.**]

Privilege	Privilege Code	Privilege Type	Object Types	Screen Criteria
Delete Conditional Security Delivery Rule	MSC_ DeleteCo nditSecur DelivRule	System	n/a	Delete button

6.4.3.61 Countries - Search/List Screen

△ [▶ **Error! Bookmark not defined.**]

Privilege	Privilege Code	Privilege Type	Object Types	Screen Criteria
Country Query	SDQ_ Country Query	System	n/a	n/a

6.4.3.62 CSD Account Link - New/Edit Screen

△ [▶ **Error! Bookmark not defined.**]

Privilege	Privilege Code	Privilege Type	Object Types	Screen Criteria
Create CSD Account Link	SAC_ Create CSDAcco untLink	System	n/a	New mode
Update CSD Account Link	SAC_ Update CSDAcco untLink	System	n/a	Edit mode

6.4.3.63 CSD Account Links - Search/List Screen

△ [▶ **Error! Bookmark not defined.**]

Privilege	Privilege Code	Privilege Type	Object Types	Screen Criteria
Delete CSD Account Link	SAC_ Delete CSDAcco untLink	System	n/a	<i>Delete</i> button
CSD Account Link Query	SAQ_ CSDAcco untLink Query	System	n/a	n/a

6.4.3.64 Cumulative Billing Data - Details Screen

△ [▶ **Error! Bookmark not defined.**]

Privilege	Privilege Code	Privilege Type	Object Types	Screen Criteria
Cumulative Billing Data Query	BIQ_CumulativeBillDataDetailsQuery	Object	Party	n/a

6.4.3.65 Cumulative Billing Data - Search/List Screen

△ [▶ Error! Bookmark not defined.]

Privilege	Privilege Code	Privilege Type	Object Types	Screen Criteria
Cumulative Billing Data List Query	BIQ_CumulativeBillDataListQuery	Object	Party	n/a
Cumulative Billing Data Query	BIQ_CumulativeBillDataDetailsQuery	Object	Party	n/a

6.4.3.66 Currencies - Search/List Screen

△ [▶ Error! Bookmark not defined.]

Privilege	Privilege Code	Privilege Type	Object Types	Screen Criteria
Currency Query	SDQ_CurrencyQuery	System	n/a	n/a

6.4.3.67 Daily Price - New/Edit Screen

△

Privilege	Privilege Code	Privilege Type	Object Types	Screen Criteria
Create Daily Price	SPD_CreateDailyPrice	System	n/a	n/a
Update Daily Price	SPD_UpdateDailyPrice	System	n/a	n/a{CR-654}

6.4.3.68 Daily Price - Search/List Screen

△

Privilege	Privilege Code	Privilege Type	Object Types	Screen Criteria
Daily Price Query	SPQ_DailyPriceQuery	System	n/a	n/a
Delete Daily Price	SPD_DeleteDailyPrice	System	n/a	n/a{CR-654}

~~6.4.3.69 Daily Schedules - Search/List Screen~~

~~△ [▶ 43]~~

Privilege	Privilege Code	Privilege Type	Object Types	Screen Criteria
Current Status of the T2S Settlement Day	SCQ_CurrStatusOfT2SSettlDay	System	n/a	n/a
T2S Diary Query	SCQ_T2SDiaryQuery	System	n/a	n/a

6.4.3.70 Data Change - Details Screen

△ [▶ 47]

Privilege	Privilege Code	Privilege Type	Object Types	Screen Criteria
Data Changes of a Business Object List Query	DDQ_ Data Chan- Business ObjList Query	System	n/a	n/a
Data Changes of a Business Object Details Query	DDQ_ Data Chan- Business ObjDetail Query	System	n/a	n/a

6.4.3.71 Data Changes - Search/List Screen

△ [▶ 47]

Privilege	Privilege Code	Privilege Type	Object Types	Screen Criteria
Data Changes of a Business Object List Query	DDQ_ Data Chan- Business ObjList Query	System	n/a	n/a
Data Changes of a Business Object Details Query	DDQ_ Data Chan- Business ObjDetail Query	System	n/a	n/a

6.4.3.72 Eligible Counterpart CSD - Details Screen

△ [▶ **Error! Bookmark not defined.**]

Privilege	Privilege Code	Privilege Type	Object Types	Screen Criteria
Eligible Counterpart CSD Details Query	SEQ_ Eligible Counterp CSD Details Query	System	n/a	n/a
Delete Eligible Counterpart CSD Link	SDM_ Delete Eligible Counterp CSDLink	System	n/a	Delete button

6.4.3.73 Eligible Counterpart CSD - New/Edit Screen

△ [▶ **Error! Bookmark not defined.**]

Privilege	Privilege Code	Privilege Type	Object Types	Screen Criteria
Create Eligible Counterpart CSD Link	SDM_ Create Eligible Counterp CSDLink	System	n/a	New mode
Update Eligible Counterpart CSD Link	SDM_ Update Eligible Counterp CSDLink	System	n/a	Edit mode

6.4.3.74 Eligible Counterpart CSDs - Search/List Screen

△ [▶ **Error! Bookmark not defined.**]

Privilege	Privilege Code	Privilege Type	Object Types	Screen Criteria
Eligible Counterpart CSD List Query	SEQ_ Eligible Counterp CSDList Query	System	n/a	n/a
Delete Eligible Counterpart CSD Link	SDM_ Delete Eligible Counterp CSDLink	System	n/a	Delete button

6.4.3.75 Euro Foreign Exchange Reference Rate - New/Edit Screen

△

Privilege	Privilege Code	Privilege Type	Object Types	Screen Criteria
Create Euro Foreign Exchange Rate	SPD_CreateEuroForeignExchangeRate	System	n/a	n/a
Update Euro Foreign Exchange Rate	SPD_UpdateEuroForeignExchangeRate	System	n/a	n/a{CR-654}

6.4.3.76 Euro Foreign Exchange Reference Data - Search/List Screen

△

Privilege	Privilege Code	Privilege Type	Object Types	Screen Criteria
Euro Foreign Exchange Rate Query	SPQ_EuroForeignExchangeRateQuery	System	n/a	n/a
Delete Euro Foreign Exchange Rate	SPD_DeleteEuroForeignExchangeRate	System	n/a	n/a{CR-654}

Privilege	Privilege Code	Privilege Type	Object Types	Screen Criteria
<u>Foreign Exchange Rate</u>	<u>roForeignExchangeRate</u>			

6.4.3.77 Event Type - Details Screen

△ [▶ **Error! Bookmark not defined.**]

Privilege	Privilege Code	Privilege Type	Object Types	Screen Criteria
Event Type Details Query	SCQ_EventTypeDetailsQuery	System	n/a	n/a

6.4.3.78 Event Types - Search/List Screen

△ [▶ **Error! Bookmark not defined.**]

Privilege	Privilege Code	Privilege Type	Object Types	Screen Criteria
Event Type List Query	SCQ_EventTypeListQuery	System	n/a	n/a

6.4.3.79 External RTGS Account - Details Screen

△ [▶ **Error! Bookmark not defined.**]

Privilege	Privilege Code	Privilege Type	Object Types	Screen Criteria
External RTGS Account Details Query	DCQ_ExtRTGSAccountDetailsQuery	System	n/a	n/a
Delete External RTGS Account	DCA_Delete	System	n/a	Delete button

Privilege	Privilege Code	Privilege Type	Object Types	Screen Criteria
	External RTGS Account			

6.4.3.80 External RTGS Account - New/Edit Screen

△ [▶ **Error! Bookmark not defined.**]

Privilege	Privilege Code	Privilege Type	Object Types	Screen Criteria
Create External RTGS Account	DCA_ Create External RTGS Account	System	n/a	New mode
Update External RTGS Account	DCA_ Update External RTGS Account	System	n/a	Edit mode

6.4.3.81 External RTGS Accounts - Search/List Screen

△ [▶ **Error! Bookmark not defined.**]

Privilege	Privilege Code	Privilege Type	Object Types	Screen Criteria
External RTGS Account List Query	DCQ_ ExtRTGS Account ListQuery	System	n/a	n/a
Delete External RTGS Account	DCA_ Delete External RTGS Account	System	n/a	Delete button

6.4.3.82 Grant/Revoke Cross-System Entity Object Privilege - Details Screen

△ [▶ **Error! Bookmark not defined.**]

Privilege	Privilege Code	Privilege Type	Object Types	Screen Criteria
Granted Object Privileges List Query	ARQ_GrantObjectPrivilegesListQuery	System	n/a	n/a

6.4.3.83 Grant/Revoke Cross-System Entity Object Privilege - New/Edit Screen

△ [▶ **Error! Bookmark not defined.**]

Privilege	Privilege Code	Privilege Type	Object Types	Screen Criteria
Grant privilege	ARM_GrantPrivilege	System	n/a	n/a
Revoke privilege	ARM_RevokePrivilege	System	n/a	n/a

6.4.3.84 Grant/Revoke Object Privilege - Details Screen

△ [▶ **Error! Bookmark not defined.**]

Privilege	Privilege Code	Privilege Type	Object Types	Screen Criteria
Granted Object Privileges List Query	ARQ_GrantObjectPrivilegesListQuery	System	n/a	n/a

6.4.3.85 Grant/Revoke Object Privilege - New/Edit Screen

△ [▶ **Error! Bookmark not defined.**]

Privilege	Privilege Code	Privilege Type	Object Types	Screen Criteria
Grant Privilege	ARM_ Grant Privilege	System	n/a	n/a
Revoke Privilege	ARM_ Revoke Privilege	System	n/a	n/a

6.4.3.86 Grant/Revoke Privileges - Search Screen

△ [▶ **Error! Bookmark not defined.**]

Privilege	Privilege Code	Privilege Type	Object Types	Screen Criteria
Privilege Query	ARQ_ Privilege Query	System	n/a	n/a

6.4.3.87 Grant/Revoke Role - Details Screen

△ [▶ **Error! Bookmark not defined.**]

Privilege	Privilege Code	Privilege Type	Object Types	Screen Criteria
Granted Roles List Query	ARQ_ Granted RolesList Query	System	n/a	n/a

6.4.3.88 Grant/Revoke Role - New/Edit Screen

△ [▶ **Error! Bookmark not defined.**]

Privilege	Privilege Code	Privilege Type	Object Types	Screen Criteria
Grant/Revoke Role	ARM_	System	n/a	n/a

Privilege	Privilege Code	Privilege Type	Object Types	Screen Criteria
	GrantRole			

6.4.3.89 Grant/Revoke System Privilege - Details Screen

△ [▶ Error! Bookmark not defined.]

Privilege	Privilege Code	Privilege Type	Object Types	Screen Criteria
Granted System Privileges List Query	ARQ_Granted SysPrivilegesList Query	System	n/a	n/a

6.4.3.90 Grant/Revoke System Privilege - New/Edit Screen

△ [▶ Error! Bookmark not defined.]

Privilege	Privilege Code	Privilege Type	Object Types	Screen Criteria
Grant Privilege	ARM_Grant Privilege	System	n/a	n/a
Revoke Privilege	ARM_Revoke Privilege	System	n/a	n/a

6.4.3.91 Granted Roles - Search/List Screen

△ [▶ Error! Bookmark not defined.]

Privilege	Privilege Code	Privilege Type	Object Types	Screen Criteria
Granted Roles List Query	ARQ_ Granted Roles ListQuery	System	n/a	n/a
Grant/Revoke Role	ARM_ GrantRole	System	n/a	n/a

6.4.3.92 Hold/Release Instruction - Details Screen

△ [▶ **Error! Bookmark not defined.**]

Privilege	Privilege Code	Privilege Type	Object Types	Screen Criteria
Hold/Release Instruction Audit Trail List Query	DDQ_ HoldRele InstrAud itTrail LisQuery	Object	Securities Account (analog Hold/Releas e Instruction Query)	n/a

6.4.3.93 Hold/Release Instruction - New Screen

△ [▶ **Error! Bookmark not defined.**]

Privilege	Privilege Code	Privilege Type	Object Types	Screen Criteria
Party Hold Settlement Instruction on a Securities Account or on Behalf of an external CSD	SIG_PTY HI	Object	Party Securities Account	Party Hold (flagged)
CSD Hold Settlement Instruction either on a Securities Account or on Behalf of the CSD in T2S	SIC_CS DHI	Object	Securities Account/Party	CSD Hold (flagged)
Release Party Hold Settlement Instruction on a Securities Account	SIG_RP TYH	Object	Securities Account/Party	Party Release (flagged)

Privilege	Privilege Code	Privilege Type	Object Types	Screen Criteria
or on Behalf of an external CSD				
Release Party Hold Auto-collateralisation Instruction on a Securities Account	SIG_RP TYA	Object	Securities Account/Party	Party Release (flagged)
Release CSD Hold Settlement Instruction either on a Securities Account or on Behalf of the CSD in T2S	SIC_RC SDH	Object	Securities Account/Party	CSD Release (flagged)
Release CSD Validation Hold Settlement Instruction either on a Securities Account or on Behalf of the CSD in T2S	SIC_RC SDV	Object	Securities Account/Party	CSD Validation Release (flagged)
Release CoSD Hold Settlement Instruction on Behalf of an Administering Party	SIC_RC OSD	Object	Party	CoSD Release (flagged)
Hold Non-modifiable Instructions on behalf of the Instructing party of the Underlying Settlement Instruction	SIC_HN MBI	Object	Party	n/a
Release Non-modifiable Instructions on behalf of the Instructing party of the Underlying Settlement Instruction	SIC_RN MBI	Object	Party	n/a

6.4.3.94 Immediate Liquidity Transfer Order - New Screen

△ [▶ **Error! Bookmark not defined.**]

Privilege	Privilege Code	Privilege Type	Object Types	Screen Criteria
Send New Liquidity Transfer	CAM_Send New Liquidity Transfer	Object	Party T2S Dedicated Cash Account	n/a

6.4.3.95 Immediate Liquidity Transfer Order- Details Screen

△ [▶ **Error! Bookmark not defined.**]

Privilege	Privilege Code	Privilege Type	Object Types	Screen Criteria
Immediate Liquidity Transfer Order Detail Query	DDQ_ImmedLiquidityTransferOrderDetailQuery	Object	T2S Dedicated Cash Account	n/a
Immediate Liquidity Transfer Order Audit Trail List Query	DDQ_ImmedLiquidityTransferOrderAuditTrailListQuery	Object	T2S Dedicated Cash Account	n/a

6.4.3.96 Immediate Liquidity Transfer Orders - Search/List Screen

△ [▶ **Error! Bookmark not defined.**]

Privilege	Privilege Code	Privilege Type	Object Types	Screen Criteria
Immediate Liquidity Transfer Order List Query	DDQ_ImmedLiquidityTransferOrderListQuery	Object	T2S Dedicated Cash Account	n/a
Immediate Liquidity Transfer Order Detail Query	DDQ_ImmedLiquidityTransferOrderDetailQuery	Object	T2S Dedicated Cash Account	n/a

Privilege	Privilege Code	Privilege Type	Object Types	Screen Criteria
	OrderDet Query			

6.4.3.97 Inbound File - Details Screen

△ [▶ **Error! Bookmark not defined.**]

Privilege	Privilege Code	Privilege Type	Object Types	Screen Criteria
Inbound Files Details Query	DDQ_Inbound Files Details Query	System	n/a	n/a

6.4.3.98 Inbound Files - Search/List Screen

△ [▶ **Error! Bookmark not defined.**]

Privilege	Privilege Code	Privilege Type	Object Types	Screen Criteria
Inbound Files List Query	DDQ_Inbound FilesList Query	System	n/a	n/a

6.4.3.99 Inbound Message - Details Screen

△ [▶ **Error! Bookmark not defined.**]

Privilege	Privilege Code	Privilege Type	Object Types	Screen Criteria
Inbound Message Details Query	DDQ_Inbound Mess Details Query	System	n/a	n/a

6.4.3.100 Inbound Messages - Search/List Screen

△ [▶ **Error! Bookmark not defined.**]

Privilege	Privilege Code	Privilege Type	Object Types	Screen Criteria
Inbound Message List Query	DDQ_InboundMessListQuery	System	n/a	n/a

6.4.3.101 Insolvency procedure Settlement Instructions - Search/List Screen

△ [▶ **Error! Bookmark not defined.**]

Privilege	Privilege Code	Privilege Type	Object Types	Screen Criteria
Settlement Instruction Matched and Accepted Status Query Privilege	DDQ_SettlementInstructionMatchAcceptedStatusQuery	Object	Securities Account, Party	n/a

6.4.3.102 Intra-Balance Movement - Details Screen

△ [▶ **Error! Bookmark not defined.**]

Privilege	Privilege Code	Privilege Type	Object Types	Screen Criteria
Intra-Balance Movement Audit Trail List Query	DDQ_IntraBalanceMovementAuditTrailListQuery	Object	T2S Dedicated Cash Account	n/a

6.4.3.103 Intra-Balance Movement - New Screen

△ [▶ **Error! Bookmark not defined.**]

Privilege	Privilege Code	Privilege Type	Object Types	Screen Criteria
Send New Settlement Restriction on Cash on a Dedicated Cash Account	CAM_SN DRC	Object	T2S Dedicated Cash Account	Dedicated Cash Account Number (just for the object)
Unblock CoSD Cash Blocking related to cancelled CoSD Settlement Instructions on Behalf of the relevant CSD in T2S	CAM_UC BBI	Object	Party	n/a
Link to an Instruction/Pool Reference belonging to a specific Party	SIG_LIP RP	Object	Party	Actor Reference or T2S Reference in Linkages block
Send new instruction using a specific Instructing Party	SIG_SIU IP	Object	Party	n/a

6.4.3.104 Intra-Balance Movements - Search/List Screen

△ [▶ **Error! Bookmark not defined.**]

Privilege	Privilege Code	Privilege Type	Object Types	Screen Criteria
Intra-Balance Movements Query	DDQ_IntraBalanceMov Query	Object	T2S Dedicated Cash Account	n/a

6.4.3.105 Intra-Position Movement - Details Screen

△ [▶ **Error! Bookmark not defined.**]

Privilege	Privilege Code	Privilege Type	Object Types	Screen Criteria
Intra-Position Movements Query	DDQ_Int raPosMov Query	Object	Securities Account	n/a

6.4.3.106 Intra-Position Movement - New Screen

△ [▶ **Error! Bookmark not defined.**]

Privilege	Privilege Code	Privilege Type	Object Types	Screen Criteria
Send New Settlement Instruction/Settlement Restriction on Securities either on a Securities Account or on Behalf of an external CSD	SIG_SN DSI	Object	Securities Account	Securities Account (just for the object)
Unblock CoSD Securities Blocking related to cancelled CoSD Settlement Instructions on Behalf of the relevant CSD in T2S	SIC_US BBI	Object	Party	n/a
Link to an Instruction / Pool Reference belonging to a specific Party	SIG_LIP RP	Object	Party	Actor Reference or T2S Reference in Linkages block
Send new instruction using a specific Instructing Party	SIG_SIU IP	Object	Party	n/a

6.4.3.107 Intra-Position Movements - Search/List Screen

△ [▶ **Error! Bookmark not defined.**]

Privilege	Privilege Code	Privilege Type	Object Types	Screen Criteria
Intra-Position Move-	DDQ_Int	Object	Securities	n/a

Privilege	Privilege Code	Privilege Type	Object Types	Screen Criteria
ments Query	raPosMov Query		Account	

6.4.3.108 Itemised Billing Data - Details Screen

△ [▶ 47]

Privilege	Privilege Code	Privilege Type	Object Types	Screen Criteria
Itemised Billing Data Query	BIQ_ Itemised BillData Details Query	Object	Party	n/a

6.4.3.109 Itemised Billing Data - Search/List Screen

△ [▶ 47]

Privilege	Privilege Code	Privilege Type	Object Types	Screen Criteria
Itemised Billing Data List Query	BIQ_ Itemised BillData ListQuery	Object	Party	n/a
Itemised Billing Data Query	BIQ_ Itemised BillData Details Query	Object	Party	n/a

6.4.3.110 Limit - New/Edit Screen

△ [▶ **Error! Bookmark not defined.**]

Privilege	Privilege Code	Privilege Type	Object Types	Screen Criteria
Create Limit	DCA_ Create Limit	System	n/a	New mode
Update Limit	DCA_ Update Limit	System	n/a	Edit mode

6.4.3.111 Limit Utilisation - Search/List Screen

△ [▶ **Error! Bookmark not defined.**]

Privilege	Privilege Code	Privilege Type	Object Types	Screen Criteria
Limit Utilisation Query	DDQ_ LimitUti lisation Query	System	n/a	n/a

6.4.3.112 Limit Utilisation Journal - Search/List Screen

△ [▶ **Error! Bookmark not defined.**]

Privilege	Privilege Code	Privilege Type	Object Types	Screen Criteria
Limit Utilisation Journal Query	DDQ_ LimitUti lisation Journal Query	System	n/a	n/a

6.4.3.113 Limits - Search/List Screen

△ [▶ **Error! Bookmark not defined.**]

Privilege	Privilege Code	Privilege Type	Object Types	Screen Criteria
Delete Limit	DCA_ Delete Limit	System	n/a	Delete button
Limit Query	DCQ_ Limit Query	System	n/a	n/a

6.4.3.114 Maintenance Cash Instructions – Search/List Screen

△ [▶ **Error! Bookmark not defined.**]

Privilege	Privilege Code	Privilege Type	Object Types	Screen Criteria
Cancellation Instructions for Intra-Balance Movements Query	DDQ_ CanlInstr uctIntra BalanMov Query	Object	T2S Dedicat- ed Cash Ac- count	'Maintenance In- struction Type'. Mandatory field that identify the kind of Mainte- nance Instruction queried.
Maintenance Instruction for Intra-Balance Movements Query	DDQ_ Maint InstrFor IntraBa lanMov Quer	Object	T2S Dedicat- ed Cash Ac- count	'Maintenance In- struction Type'. Mandatory field that identify the kind of Mainte- nance Instruction queried.
Amendment Instruction Query for Intra-Balance Movements	DDQ_ Amend Instr Query ForIntra BalanMov	Object	T2S Dedicat- ed Cash Ac- count	'Maintenance In- struction Type'. Mandatory field that identify the kind of Mainte- nance Instruction queried.

6.4.3.115 Maintenance Securities Instructions – Search/List Screen

△ [▶ **Error! Bookmark not defined.**]

Privilege	Privilege Code	Privilege Type	Object Types	Screen Criteria
Cancellation Instruction Query for Intra-Position Movements and Settlement Instructions	DDQ_ CanlInstr ForSI+Int traPosMov Query	Object	Securities Account	'Maintenance Instruction Type' Mandatory field that identify the kind of Maintenance Instruction queried.
Maintenance for Intra-Position Movements and Settlement Instructions Query	DDQ_ MaintFor IntraPos Mov+Set tlInstrQ	Object	Securities Account	'Maintenance Instruction Type' Mandatory field that identify the kind of Maintenance Instruction queried.
Amendment Instruction Query for Intra-Position Movements and Settlement Instructions	DDQ_ Amend InstrQ IntraPos Mov+Set Instr	Object	Securities Account	'Maintenance Instruction Type' Mandatory field that identify the kind of Maintenance Instruction queried.

6.4.3.116 Market-Specific Attribute - Details Screen

△ [▶ **Error! Bookmark not defined.**]

Privilege	Privilege Code	Privilege Type	Object Types	Screen Criteria
Market-Specific Attribute Detail Query	MSA_ Market-Spec Attribute Detail Query	System	n/a	n/a
Delete Market-Specific Attribute	MSC_ Delete Market-Specific Attribute	System	n/a	Delete button

6.4.3.117 Market-Specific Attribute - New/Edit Screen

△ [▶ **Error! Bookmark not defined.**]

Privilege	Privilege Code	Privilege Type	Object Types	Screen Criteria
Create Market-Specific Attribute	MSC_ Create Market-Specific Attribute	System	n/a	New mode
Update Market-Specific Attribute	MSC_ Update Market-Specific Attribute	System	n/a	Edit mode

6.4.3.118 Market-Specific Attributes - Search/List Screen

△ [▶ **Error! Bookmark not defined.**]

Privilege	Privilege Code	Privilege Type	Object Types	Screen Criteria
Market-Specific Attribute List Query	MSA_ Market-Spec Attribute Query	System	n/a	n/a
Delete Market-Specific Attribute	MSC_ Delete Market-Specific Attribute	System	n/a	Delete button

6.4.3.119 Message Subscription Rule - New/Edit Screen

△ [▶ **Error! Bookmark not defined.**]

Privilege	Privilege Code	Privilege Type	Object Types	Screen Criteria
Create Message Subscription Rule Set	MSU_ Create Mess Subs RuleSet	System	n/a	New mode
Update Message Subscription Rule Set	MSU_ Update MessSub scription RuleSet	System	n/a	Edit mode

6.4.3.120 Message Subscription Rule Set - Details Screen

△ [▶ **Error! Bookmark not defined.**]

Privilege	Privilege Code	Privilege Type	Object Types	Screen Criteria
Message Subscription Rule Set Details Query	MSQ_ Mess Subscr RuleSet Detail Query	System	n/a	n/a
Delete Message Subscription Rule Set	MSU_ Delete Mess Subscrip tionRule Set	System	n/a	Delete button

6.4.3.121 Message Subscription Rule Set - New/Edit Screen

△ [▶ **Error! Bookmark not defined.**]

Privilege	Privilege Code	Privilege Type	Object Types	Screen Criteria
Create Message Subscription Rule	MSU_ Create Message Subscrip tionRule	System	n/a	New mode
Update Message Subscription Rule	MSU_ Update Message Subscrip tionRule	System	n/a	Edit mode

6.4.3.122 Message Subscription Rule Sets - Search/List Screen

△ [▶ **Error! Bookmark not defined.**]

Privilege	Privilege Code	Privilege Type	Object Types	Screen Criteria
Message Subscription Rule Set List Query	MSQ_MessSubscrRuleSetListQuery	System	n/a	n/a
Message Subscription Rule Sets Details Query	MSQ_MessSubscrRuleSetDetailQuery	System	n/a	n/a
Delete Message Subscription Rule Set	MSU_DeleteMessSubscriptionRuleSet	System	n/a	Delete button

6.4.3.123 Message Subscription Rules - List Screen

△ [▶ Error! Bookmark not defined.]

Privilege	Privilege Code	Privilege Type	Object Types	Screen Criteria
Message Subscription Rule List Query	MSQ_MessSubscrRuleListQuery	System	n/a	n/a
Delete Message Subscription Rule	MSU_DeleteMessageSubscriptionRule	System	n/a	Delete button

6.4.3.124 Network Services - Search/List Screen

△ [▶ Error! Bookmark not defined.]

Privilege	Privilege Code	Privilege Type	Object Types	Screen Criteria
Network Service List Query	NCQ_Network Service ListQuery	System	n/a	n/a

6.4.3.125 Outbound File - Details Screen

△ [▶ **Error! Bookmark not defined.**]

Privilege	Privilege Code	Privilege Type	Object Types	Screen Criteria
Outbound Files Details Query	DDQ_Outbound FilesDetailsQuery	System	n/a	n/a
Resend Communication	MMA_Resend-Communication	Object	Party	'Resend' button

6.4.3.126 Outbound Files - Search/List Screen

△ [▶ **Error! Bookmark not defined.**]

Privilege	Privilege Code	Privilege Type	Object Types	Screen Criteria
Outbound Files List Query	DDQ_Outbound FilesList Query	System	n/a	n/a
Outbound Files Details Query	DDQ_Outbound Files Details Query	System	n/a	n/a
Resend Communication	MMA_Resend-Commu-	Object	Party	'Resend' button

Privilege	Privilege Code	Privilege Type	Object Types	Screen Criteria
	nication			

6.4.3.127 Outbound Message - Details Screen

△ [▶ **Error! Bookmark not defined.**]

Privilege	Privilege Code	Privilege Type	Object Types	Screen Criteria
Outbound Message Details Query	DDQ_OutboundMessDetailsQuery	System	n/a	n/a
Resend Communication	MMA_Resend-Communication	Object	Party	'Resend' button

6.4.3.128 Outbound Messages - Search/List Screen

△ [▶ **Error! Bookmark not defined.**]

Privilege	Privilege Code	Privilege Type	Object Types	Screen Criteria
Outbound Message List Query	DDQ_OutboundMessListQuery	System	n/a	n/a
Outbound Message Details Query	DDQ_OutboundMessDetailsQuery	System	n/a	n/a
Resend Communication	MMA_Resend-Communication	Object	Party	'Resend' button

6.4.3.129 Outstanding Auto-Collateralisation Credits - Search/List Screen

△ [▶ **Error! Bookmark not defined.**]

Privilege	Privilege Code	Privilege Type	Object Types	Screen Criteria
Outstanding Auto-Collateralisation Credit Query	DDQ_ Outstand Auto-Coll Credit Query	System	n/a	n/a

6.4.3.130 Overall Liquidity - Search/List Screen

△ [▶ **Error! Bookmark not defined.**]

Privilege	Privilege Code	Privilege Type	Object Types	Screen Criteria
T2S Overall Liquidity Query	DDQ_ T2S Overall Liquidity Query	Object	Party	n/a

6.4.3.131 Partial Settlement Thresholds - Search/List Screen

△ [▶ **Error! Bookmark not defined.**]

Privilege	Privilege Code	Privilege Type	Object Types	Screen Criteria
Partial Settlement Threshold Query	SDQ_ Partial SettlThre shold Query	System	n/a	n/a

6.4.3.132 Parties - Search/List Screen

△ [▶ **Error! Bookmark not defined.**]

Privilege	Privilege Code	Privilege Type	Object Types	Screen Criteria
Party List Query	PDQ_PartyList Query	Object	Party	n/a
Delete Party	PDM_Delete Party	Object	Party	<i>Delete</i> button

6.4.3.133 Party - Details Screen

△ [▶ **Error! Bookmark not defined.**]

Privilege	Privilege Code	Privilege Type	Object Types	Screen Criteria
Party Reference Data Query	PDQ_PartyReferData Query	Object	Party	n/a
Delete Party	PDM_Delete Party	Object	Party	<i>Delete</i> button
Technical Address Network Service Link Details Query	NCQ_Display-TechAddress-Net-SerLink	System	n/a	Technical address network services link button

6.4.3.134 Party - New/Edit Screen

△ [▶ **Error! Bookmark not defined.**]

Privilege	Privilege Code	Privilege Type	Object Types	Screen Criteria
Create Party	PDM_ Create Party	Object	Party	New mode
Update Party	PDM_ Update Party	Object	Party	Edit mode
Create Technical Address Network Service Link	NCO_Create- TechnAddressNet- ServLink	System	n/a	Technical address network services link button

6.4.3.135 Privileges - Search/List Screen

△ [▶ **Error! Bookmark not defined.**]

Privilege	Privilege Code	Privilege Type	Object Types	Screen Criteria
Privilege Query	ARQ_ Privilege Query	System	n/a	n/a

6.4.3.136 Queued Static Data Change - Details Screen

△ [▶ 47]

Privilege	Privilege Code	Privilege Type	Object Types	Screen Criteria
Data Changes of a Business Object Details Query	DDQ_ Data Chan- Business ObjDetail Query	System	n/a	n/a

6.4.3.137 Queued Static Data Changes - Search/List Screen

△ [▶ 47]

Privilege	Privilege Code	Privilege Type	Object Types	Screen Criteria
Data Changes of a Business Object Search Query	SDQ_ Queued-Data-Changes Query	System	n/a	n/a

6.4.3.138 Report Configuration - Details Screen

△ [▶ **Error! Bookmark not defined.**]

Privilege	Privilege Code	Privilege Type	Object Types	Screen Criteria
Report Configuration Details Query	RCO_ Report Config Detail Query	System	n/a	n/a
Delete Report Configuration	RCO_ Delete Report Configuration	System	n/a	Delete button

6.4.3.139 Report Configuration - New/Edit Screen

△ [▶ **Error! Bookmark not defined.**]

Privilege	Privilege Code	Privilege Type	Object Types	Screen Criteria
Create Report Configuration	RCO_ Create Report Config uration	System	n/a	New mode
Update Report Configuration	RCO_ Update Report Config uration	System	n/a	Edit mode

6.4.3.140 Report Configurations - Search/List Screen

△ [▶ **Error! Bookmark not defined.**]

Privilege	Privilege Code	Privilege Type	Object Types	Screen Criteria
Report Configuration List Query	RCO_ Report Config List Query	System	n/a	n/a
Delete Report Configuration	RCO_ Delete Report Config uration	System	n/a	Delete button

6.4.3.141 Resend Communication Screen

△ [▶ **Error! Bookmark not defined.**]

Privilege	Privilege Code	Privilege Type	Object Types	Screen Criteria
Resend Communication	MMA_ Resend Communi cation	Object	Party	n/a

6.4.3.142 Restricted Parties - Search/List Screen

△ [▶ **Error! Bookmark not defined.**]

Privilege	Privilege Code	Privilege Type	Object Types	Screen Criteria
Restricted Party Query	PDQ_ Restrict edParty Query	Object	Party	n/a

6.4.3.143 Restriction Type - New/Edit Screen

△ [▶ **Error! Bookmark not defined.**]

Privilege	Privilege Code	Privilege Type	Object Types	Screen Criteria
Create Restriction Type	MSC_ Create Restrict ionType	System	n/a	New mode
Update Restriction Type	MSC_ Update Restrict ionType	System	n/a	Edit mode

6.4.3.144 Restriction Type Rule - Details Screen

△ [▶ **Error! Bookmark not defined.**]

Privilege	Privilege Code	Privilege Type	Object Types	Screen Criteria
Market-Specific Restriction Type Rule Detail Query	MSA_Market-Spec Restrict Detail Query	System	n/a	n/a
Market-Specific Restriction Type Rule Parameter Details Query	MSA_MarkSpecRestrTypeRuleParamDetQ	System	n/a	n/a
Delete Restriction Type Rule	MSC_Delete RestrictionType Rule	System	n/a	Delete button

6.4.3.145 Restriction Type Rule - New/Edit Screen

△ [▶ Error! Bookmark not defined.]

Privilege	Privilege Code	Privilege Type	Object Types	Screen Criteria
Create Restriction Type Rule	MSC_Create RestrictionType Rule	System	n/a	New mode
Update Restriction Type Rule	MSC_Update RestrictionType Rule	System	n/a	Edit mode

6.4.3.146 Restriction Type Rule Sets - List Screen

△ [▶ Error! Bookmark not defined.]

Privilege	Privilege Code	Privilege Type	Object Types	Screen Criteria
Market-Specific Restriction Type Rule Set List Query	MSA_MarkSpecRestrTypeRuleSetListQue	System	n/a	n/a
Delete Restriction Type Rule	MSC_DeleteRestrictionTypeRule	System	n/a	Delete button

6.4.3.147 Restriction Types - Search/List Screen

△ [▶ Error! Bookmark not defined.]

Privilege	Privilege Code	Privilege Type	Object Types	Screen Criteria
Market-Specific Restriction List Query	MSA_MarketSpecRestrictListQuery	System	n/a	n/a
Delete Restriction Type	MSC_DeleteRestrictionType	System	n/a	Delete button

6.4.3.148 Revisions/Audit Trail - Details Screen

△ [▶ Error! Bookmark not defined.]

Privilege	Privilege Code	Privilege Type	Object Types	Screen Criteria
Party Audit Trail Query	PDQ_PartyAudTrailQuery	Object	Party	Object Type = Party
Residual Static Data Audit Trail Query	SDQ_ResidualStaticDataAudTrailQuery	System	n/a	Object Type is not Party, T2S Dedicated Cash Account, Securities or Securities Account
Securities Account Audit Trail Query	SAQ_SecuritiesAccAudTrailQuery	Object	Securities Account	Object Type = Securities Account
Securities Audit Trail Query	SEQ_SecuritiesAudTrailQuery	Object	Security	Object Type = Securities
T2S Dedicated Cash Account Audit Trail Query	DCQ_T2SDedicCashAccAudTrailQuery	Object	T2S Dedicated Cash Account	Object Type = T2S Dedicated Cash Account

6.4.3.149 Revisions/Audit Trail - List Screen

△ [▶ **Error! Bookmark not defined.**]

Privilege	Privilege Code	Privilege Type	Object Types	Screen Criteria
Amendment Instruction for Intra-Position Movement or Settlement Instruction Audit Trail List Query	DDQ_AmdIn-sIntrPosMovSetInsAudTrLisQ	Object	Securities Account	n/a
Amendment Instruction for Intra-Balance Movement Audit Trail List Query	DDQ_AmdInstrFor-IntraBal-MovAud-TrLisQ	Object	T2S Dedicated Cash Account	n/a
Cancellation Instruction for Intra-Balance Movement Audit Trail List Query	DDQ_CanclInstrIntraBal-anMovAudTrLisQ	Object	Securities Account	n/a
Cancellation Instruction for Intra-Position Movement or Settlement Instruction Audit Trail List Query	DDQ_CanclInstrIntraPosMovAudTrLisQ	Object	T2S Dedicated Cash Account	n/a
Immediate Liquidity Transfer Order Audit Trail List Query	DDQ_ImmEdLiquid-TransOrderAud-TrListQ	Object	T2S Dedicated Cash Account	n/a
Intra-Balance Movement Audit Trail List Query	DDQ_IntraBal-anMovAuditTrail-LisQuery	Object	T2S Dedicated Cash Account	n/a
Intra-Position Movement Audit Trail List Query	DDQ_IntraPosMovAuditTrail-ListQuery	Object	Securities Account	n/a
Party Audit Trail Query	PDQ_PartyAud	Object	Party	Object Type = Party

Privilege	Privilege Code	Privilege Type	Object Types	Screen Criteria
	Trail Query			
Securities Account Audit Trail Query	SAQ_SecuritiesAccAudTrailQuery	Object	Securities Account	Object Type = Securities Account
Securities Audit Trail Query	SEQ_SecuritiesAuditTrailQuery	Object	Security	Object Type = Securities
Settlement Instruction Audit Trail Query	DDQ_SettlementInstructionAuditTrailQuery	Object	Securities Account Party	n/a
T2S Dedicated Cash Account Audit Trail Query	DCQ_T2SDedicatedCashAccAudTrailQuery	Object	T2S Dedicated Cash Account	Object Type = T2S Dedicated Cash Account
Residual Static Data Audit Trail Query	SDQ_ResidualStaticDataAuditTrailQuery	System	n/a	Object Type is not Party, T2S Dedicated Cash Account, Securities or Securities Account

6.4.3.150 Role - New/Edit Screen

△ [▶ **Error! Bookmark not defined.**]

Privilege	Privilege Code	Privilege Type	Object Types	Screen Criteria
Create Role	ARM_ Create Role	System	n/a	New mode
Update Role	ARM_ Update Role	System	n/a	Edit mode

6.4.3.151 Roles - Search/List Screen

△ [▶ **Error! Bookmark not defined.**]

Privilege	Privilege Code	Privilege Type	Object Types	Screen Criteria
Role List Query	ARQ_ RoleList Query	System	n/a	n/a
Delete Role	ARM- Delete Role	System	n/a	n/a

6.4.3.152 Routing - New/Edit Screen

△ [▶ **Error! Bookmark not defined.**]

Privilege	Privilege Code	Privilege Type	Object Types	Screen Criteria
Create Routing	NCO_ Create Routing	System	n/a	New mode
Update Routing	NCO_ Update Routing	System	n/a	Edit mode

6.4.3.153 Routings - Search/List Screen

△ [▶ **Error! Bookmark not defined.**]

Privilege	Privilege Code	Privilege Type	Object Types	Screen Criteria
Routing List Query	NCQ_ Routing ListQuery	System	n/a	n/a
Delete Routing	NCO_ Delete Routing	System	n/a	Delete button

6.4.3.154 Secured Group - Details Screen

△ [▶ **Error! Bookmark not defined.**]

Privilege	Privilege Code	Privilege Type	Object Types	Screen Criteria
Secured Group Details Query	ARQ_ Secured Group Details Query	System	n/a	n/a
Delete Secured Group	ARM_ Delete Secured Group	System	n/a	Delete button

6.4.3.155 Secured Group - New/Edit Screen

△ [▶ **Error! Bookmark not defined.**]

Privilege	Privilege Code	Privilege Type	Object Types	Screen Criteria
Create Secured Group	ARM_ Create Secured Group	System	n/a	New mode
Update Secured Group	ARM_ Update	System	n/a	Edit mode

Privilege	Privilege Code	Privilege Type	Object Types	Screen Criteria
	Secured Group			

6.4.3.156 Secured Groups - Search/List Screen

△ [▶ **Error! Bookmark not defined.**]

Privilege	Privilege Code	Privilege Type	Object Types	Screen Criteria
Secured Group List Query	ARQ_SecuredGroupListQuery	System	n/a	n/a

6.4.3.157 Securities - Search/List Screen

△ [▶ **Error! Bookmark not defined.**]

Privilege	Privilege Code	Privilege Type	Object Types	Screen Criteria
Securities Reference Data Query	SEQ_SecuritiesReferenceDataQuery	System	n/a	n/a
ISIN List Query	SEQ_ISINListQuery	System	n/a	n/a
Delete Security	SDM_DeleteSecurity	Object	Securities	Delete button

6.4.3.158 Securities Account - Details Screen

△ [▶ **Error! Bookmark not defined.**]

Privilege	Privilege Code	Privilege Type	Object Types	Screen Criteria
Securities Account Reference Data Query	SAQ_SecuritiesAccReferenceDataQuery	Object	Party Securities Account	n/a
Delete Securities Account	SAC_DeleteSecuritiesAccount	Object	Securities Account	Delete button

6.4.3.159 Securities Account - New/Edit Screen

△ [▶ **Error! Bookmark not defined.**]

Privilege	Privilege Code	Privilege Type	Object Types	Screen Criteria
Create Securities Account	SAC_CreateSecuritiesAccount	Object	Party	New mode
Update Securities Account	SAC_UpdateSecuritiesAccount	Object	Securities Account	Edit mode

6.4.3.160 Securities Account Transfer Management - Edit Screen

△ [▶ **Error! Bookmark not defined.**]

Privilege	Privilege Code	Privilege Type	Object Types	Screen Criteria
Update Securities Account	SAC_UpdateSecuritiesAccount	Object	Securities Account	Edit mode

6.4.3.161 Securities Accounts - Search/List Screen

△ [▶ **Error! Bookmark not defined.**]

Privilege	Privilege Code	Privilege Type	Object Types	Screen Criteria
Securities Account List Query	SAQ_ Securitie sAccount ListQuery	Object	Party	n/a
Delete Securities Account	SAC_ Delete Securitie sAccount	Object	Securities Account	Delete button

6.4.3.162 Securities Accounts Link - New/Edit Screen

△ [▶ **Error! Bookmark not defined.**]

Privilege	Privilege Code	Privilege Type	Object Types	Screen Criteria
Create CMB Securities Account Link	SAC_ Create CMBSec urities Account Link	System	n/a	New mode
Update CMB Securities Account Link	SAC_ Update CMBSec urities Account Link	System	n/a	Edit mode

6.4.3.163 Securities Accounts Links - Search/List Screen

△ [▶ **Error! Bookmark not defined.**]

Privilege	Privilege Code	Privilege Type	Object Types	Screen Criteria
Delete CMB Securities Account Link	SAC_ Delete CMBSec urities Account Link	System	n/a	Delete button
CMB Securities Account Link List Query	SAQ_ Display CMBSec AccLink List Query	System	n/a	n/a
Create CMB Securities Account Link	SAC_ Create CMBSec urities Account Link	System	n/a	New mode
Update CMB Securities Account Link	SAC_ Update CMBSec urities Account Link	System	n/a	Edit mode

6.4.3.164 Securities Position - Details Screen

△ [▶ **Error! Bookmark not defined.**]

No privileges.

6.4.3.165 Securities Positions - Search/List Screen

△ [▶ **Error! Bookmark not defined.**]

Privilege	Privilege Code	Privilege Type	Object Types	Screen Criteria
Securities Account Position Query	DDQ_ Securitie	Object	Securities Account	n/a

Privilege	Privilege Code	Privilege Type	Object Types	Screen Criteria
	sAccount Position Query			

6.4.3.166 Securities Postings - Search/List Screen

△ [▶ **Error! Bookmark not defined.**]

Privilege	Privilege Code	Privilege Type	Object Types	Screen Criteria
Securities Posting Query	DDQ_SecuritiesPosting Query	Object	Securities Account	n/a

6.4.3.167 Securities Restriction Details - Search/List Screen

△ [▶ **Error! Bookmark not defined.**]

Privilege	Privilege Code	Privilege Type	Object Types	Screen Criteria
Securities Position Detailed Restriction Details Query	DDQ_SecurPos Detailed RestrDetailsQue	Object	Securities Account	n/a

6.4.3.168 Securities Subject to Cash Penalties - Search/List Screen

△

Privilege	Privilege Code	Privilege Type	Object Types	Screen Criteria
<u>Securities Subject to Cash Penalties Query</u>	<u>SPQ_SecuritiesSubjecttoCashPenaltiesQuery</u>	<u>System</u>	<u>n/a</u>	<u>n/a</u>
<u>Delete Securities Subject to Cash Penalties</u>	<u>SPD_DeleteSecuritiesSubjecttoCashPenalties</u>	<u>System</u>	<u>n/a</u>	<u>n/a</u> {CR-654}

6.4.3.169 Securities Subject to Cash Penalties - New/Edit Screen

△

Privilege	Privilege Code	Privilege Type	Object Types	Screen Criteria
<u>Create Securities Subject to Cash Penalties</u>	<u>SPD_CreateSecuritiesSubjecttoCashPe</u>	<u>System</u>	<u>n/a</u>	<u>n/a</u>
<u>Update Securities Subject to Cash Penalties</u>	<u>SPD_UpdateSecuritiesSubjecttoCashPe</u>	<u>System</u>	<u>n/a</u>	<u>n/a</u> {CR-654}

6.4.3.170 Securities Valuation - New Screen

△ [▶ **Error! Bookmark not defined.**]

Privilege	Privilege Code	Privilege Type	Object Types	Screen Criteria
Create Securities Valuation	SDM_CreateSecuritiesValuation	System	n/a	New mode

6.4.3.171 Securities Valuations - Search/List Screen

△ [▶ **Error! Bookmark not defined.**]

Privilege	Privilege Code	Privilege Type	Object Types	Screen Criteria
Securities Valuations Query	SEQ_SecuritiesValuationsQuery	System	n/a	n/a

6.4.3.172 Security - Details Screen

△ [▶ Error! Bookmark not defined.]

Privilege	Privilege Code	Privilege Type	Object Types	Screen Criteria
Securities Reference Data Query	SEQ_SecuritiesReferenceDataQuery	System	n/a	n/a
Delete Security	SDM_DeleteSecurity	Object	Security	Delete button

6.4.3.173 Security - New/Edit Screen

△ [▶ Error! Bookmark not defined.]

Privilege	Privilege Code	Privilege Type	Object Types	Screen Criteria
Create Security	SDM_CreateSecurity	Object	Party	New mode
Update Security	SDM_UpdateSecurity	Object	Security	Edit mode

6.4.3.174 Security CSD Link - Details Screen

△ [▶ Error! Bookmark not defined.]

Privilege	Privilege Code	Privilege Type	Object Types	Screen Criteria
Securities CSD Link Query	SEQ_ SecuritiesCSDLink Query	System	n/a	n/a
Delete Securities CSD Link	SDM_ Delete Security CSDLink	System	n/a	Delete button

6.4.3.175 Security CSD Link - New/Edit Screen

△ [▶ Error! Bookmark not defined.]

Privilege	Privilege Code	Privilege Type	Object Types	Screen Criteria
Create Security CSD Link	SDM_ Create Security CSDLink	System	n/a	New mode
Update Security CSD Link	SDM_ Update Security CSDLink	System	n/a	Edit mode

6.4.3.176 Security CSD Links - Search/List Screen

△ [▶ Error! Bookmark not defined.]

Privilege	Privilege Code	Privilege Type	Object Types	Screen Criteria
Securities CSD Link Query	SEQ_ SecuritiesCSDLink Query	System	n/a	n/a
Delete Security CSD Link	SDM_ Delete Security CSDLink	System	n/a	Delete button

6.4.3.177 Security Penalty Rate - Search/List Screen

△ [▶ **Error! Bookmark not defined.**]

Privilege	Privilege Code	Privilege Type	Object Types	Screen Criteria
Security Penalty Rate Query	SPQ_SecurityPenaltyRateQuery	System	n/a	n/a{CR-654}

6.4.3.178 Service Item - Details Screen

△ [▶ **Error! Bookmark not defined.**]

Privilege	Privilege Code	Privilege Type	Object Types	Screen Criteria
Service Item Details Query	BIQ_ServiceItemDetailsQuery	System	n/a	n/a

6.4.3.179 Service Items - Search/List Screen

△ [▶ **Error! Bookmark not defined.**]

Privilege	Privilege Code	Privilege Type	Object Types	Screen Criteria
Service Item List Query	BIQ_ServiceItemListQuery	System	n/a	n/a

6.4.3.180 Settlement Days - Search/List Screen

△ [▶ XXX]

Privilege	Privilege Code	Privilege Type	Object Types	Screen Criteria
Current Status of the T2S Settlement Day	SCQ_CurrStatusOfT2SettlDay	System	n/a	n/a
T2S Diary Query	SCQ_T2SDiaryQuery	System	n/a	n/a

6.4.3.181 Settlement Instruction - Details Screen

△ [▶ **Error! Bookmark not defined.**]

Privilege	Privilege Code	Privilege Type	Object Types	Screen Criteria
Settlement Instruction Audit Trail Query	DDQ_SettlInstruCTAuditTrailQuery	Object	Securities Account, Party	n/a

6.4.3.182 Settlement Instruction - New Screen

△ [▶ **Error! Bookmark not defined.**]

Privilege	Privilege Code	Privilege Type	Object Types	Screen Criteria
Send New Settlement Instruction/Settlement Restriction on Securities either on a Securities Account or on Behalf of an external CSD	SIG_SNDSI	Object	Securities Account Party	Securities Account (just for the object)
Send Settlement Instruction with non-modifiable flag activated	SIC_SINMF	System	n/a	Allowed Modification Flag= No
Link to an Instruction / Pool Reference belong-	SIG_LIPRP	Object	Party	Actor Reference or

Privilege	Privilege Code	Privilege Type	Object Types	Screen Criteria
ing to a specific Party				T2S Reference in Linkages block
Party Hold Settlement Instruction on a Securities Account or on Behalf of an external CSD	SIG_PTY HI	Object	Securities Account Party	Party Hold (flagged)
CSD Hold Settlement Instruction either on a Securities Account or on Behalf of the CSD in T2S	SIC_CS DHI	Object	Securities Account Party	CSD Hold (flagged)
Use ISO Transaction Code AUTO (Auto-Collateralisation)	SII_UAU TO	System	n/a	Securities Transaction Type
Use ISO Transaction Code BIYI (BuyIn)	SII_UBIYI	System	n/a	Securities Transaction Type
Use ISO Transaction Code BSBK (Buy Sell Back)	SII_UBS BK	System	n/a	Securities Transaction Type
Use ISO Transaction Code CLAI (Market Claim)	SII_UCL AI	System	n/a	Securities Transaction Type
Use ISO Transaction Code CNCB (Central Bank Collateral Operation)	SII_UCN CB	System	n/a	Securities Transaction Type
Use ISO Transaction Code COLI (Collateral In)	SII_UCO LI	System	n/a	Securities Transaction Type
Use ISO Transaction Code COLO (Collateral Out)	SII_UCO LO	System	n/a	Securities Transaction Type
Use ISO Transaction Code CONV (Depository Receipt Conversion)	SII_UCO NV	System	n/a	Securities Transaction Type

Privilege	Privilege Code	Privilege Type	Object Types	Screen Criteria
Use ISO Transaction Code CORP (Corporate Action)	SII_UCORP	System	n/a	Securities Transaction Type
Use ISO Transaction Code ETFT (Exchange Traded Funds)	SII_UETF	System	n/a	Securities Transaction Type
Use ISO Transaction Code FCTA (Factor Update)	SII_UFCTA	System	n/a	Securities Transaction Type
Use ISO Transaction Code INSP (Move Of Stock)	SII_UINSP	System	n/a	Securities Transaction Type
Use ISO Transaction Code ISSU (Issuance)	SII_UISSU	System	n/a	Securities Transaction Type
Use ISO Transaction Code MKDW (Mark Down)	SII_UMKDW	System	n/a	Securities Transaction Type
Use ISO Transaction Code MKUP (Mark Up)	SII_UMKUP	System	n/a	Securities Transaction Type
Use ISO Transaction Code NETT (Netting)	SII_UNETT	System	n/a	Securities Transaction Type
Use ISO Transaction Code NSYN (Non Syndicated)	SII_UNSYN	System	n/a	Securities Transaction Type
Use ISO Transaction Code OWNE (External Account Transfer)	SII_UOWNE	System	n/a	Securities Transaction Type
Use ISO Transaction Code OWNI (Internal Account Transfer)	SII_UOWNI	System	n/a	Securities Transaction Type
Use ISO Transaction Code PAIR (Pair Off)	SII_UPAIR	System	n/a	Securities Transaction Type
Use ISO Transaction Code PLAC (Place-	SII_UPLAC	System	n/a	Securities Transaction Type

Privilege	Privilege Code	Privilege Type	Object Types	Screen Criteria
ment)				
Use ISO Transaction Code PORT (Portfolio Move)	SII_UPORT	System	n/a	Securities Transaction Type
Use ISO Transaction Code REAL (Realignment)	SII_UREAL	System	n/a	Securities Transaction Type
Use ISO Transaction Code REDI (Withdrawal)	SII_URED	System	n/a	Securities Transaction Type
Use ISO Transaction Code REDM (Redemption)	SII_UREDM	System	n/a	Securities Transaction Type
Use ISO Transaction Code RELE (Depository Receipt Release Cancellation)	SII_URELE	System	n/a	Securities Transaction Type
Use ISO Transaction Code REPU (Repo)	SII_UREPU	System	n/a	Securities Transaction Type
Use ISO Transaction Code RODE (Return Delivery Without Matching)	SII_URODE	System	n/a	Securities Transaction Type
Use ISO Transaction Code RVPO (Reverse Repo)	SII_URVPO	System	n/a	Securities Transaction Type
Use ISO Transaction Code SBBK (Sell Buy Back)	SII_USBK	System	n/a	Securities Transaction Type
Use ISO Transaction Code SBRE (Borrowing Reallocation)	SII_USBRE	System	n/a	Securities Transaction Type
Use ISO Transaction Code SECB (Securities	SII_USECB	System	n/a	Securities Transaction Type

Privilege	Privilege Code	Privilege Type	Object Types	Screen Criteria
Borrowing)				
Use ISO Transaction Code SECL (Securities Lending)	SII_USE CL	System	n/a	Securities Transaction Type
Use ISO Transaction Code SLRE (Lending Reallocation)	SII_USL RE	System	n/a	Securities Transaction Type
Use ISO Transaction Code SUBS (Subscription)	SII_USU BS	System	n/a	Securities Transaction Type
Use ISO Transaction Code SYND (Syndicate Underwriters)	SII_USY ND	System	n/a	Securities Transaction Type
Use ISO Transaction Code TBAC (TBA Closing)	SII_UTB AC	System	n/a	Securities Transaction Type
Use ISO Transaction Code TRAD (Trade)	SII_UTR AD	System	n/a	Securities Transaction Type
Use ISO Transaction Code TRPO (Triparty Repo)	SII_UTR PO	System	n/a	Securities Transaction Type
Use ISO Transaction Code TRVO (Triparty Reverse Repo)	SII_UTR VO	System	n/a	Securities Transaction Type
Use ISO Transaction Code TURN (Turnaround)	SII_UTU RN	System	n/a	Securities Transaction Type
Send new instruction using a specific Instructing Party	SIG_SIU IP	Object	Party	n/a

6.4.3.183 Settlement Instructions – Search/List Screen

△ [▶ **Error! Bookmark not defined.**]

Privilege	Privilege Code	Privilege Type	Object Types	Screen Criteria
Settlement Instruction Query	DDQ_SettlInstruct Query	Object	Securities Account, Party	n/a

6.4.3.184 SME Growth Market - Search/List Screen

△

Privilege	Privilege Code	Privilege Type	Object Types	Screen Criteria
<u>SME Growth Market Query</u>	<u>SPQ_SMEGrowth-MarketQuery</u>	<u>System</u>	<u>n/a</u>	<u>n/a{CR-654}</u>

6.4.3.185 Standing/Predefined Liquidity Transfer Order - Details Screen

△ [▶ **Error! Bookmark not defined.**]

Privilege	Privilege Code	Privilege Type	Object Types	Screen Criteria
Liquidity Transfer Order Detail Query	DCQ_LiquidTransferOrder Detail Query	Object	T2S Dedicated Account	n/a
Delete Liquidity Transfer Order	DCA_Delete Liquidity Transfer Order	Object	T2S Dedicated Cash Account	Delete button

6.4.3.186 Standing/Predefined Liquidity Transfer Order - New/Edit Screen

△ [▶ **Error! Bookmark not defined.**]

Privilege	Privilege Code	Privilege Type	Object Types	Screen Criteria
Create Liquidity Transfer Order	DCA_ Create Liquidity Transfer Order	Object	T2S Dedicat- ed Cash Ac- count	New mode
Update Liquidity Transfer Order	DCA_ Update Liquidity Transfer Order	Object	T2S Dedicat- ed Cash Ac- count	Edit mode

6.4.3.187 Standing/Predefined Liquidity Transfer Order Link Set - Details Screen

△ [▶ **Error! Bookmark not defined.**]

Privilege	Privilege Code	Privilege Type	Object Types	Screen Criteria
Delete Liquidity Transfer Order Link Set	DCA_ Delete Liquidity TranOrd erLinkSet	System	n/a	<i>Delete</i> button
Liquidity Transfer Order Link Set Query	DCQ_ Liquid Trans OrderLink SetQuery	System	n/a	n/a

6.4.3.188 Standing/Predefined Liquidity Transfer Order Link Set - New/Edit Screen

△ [▶ **Error! Bookmark not defined.**]

Privilege	Privilege Code	Privilege Type	Object Types	Screen Criteria
Create Liquidity Transfer Order Link Set	DCA_ Create Liquidity TranOrd erLinkSet	System	n/a	New mode
Update Liquidity Transfer Order Link Set	DCA_ Update Liquidity TranOrd erLinkSet	System	n/a	Edit mode

6.4.3.189 Standing/Predefined Liquidity Transfer Order Link Sets - Search/List Screen

△ [▶ **Error! Bookmark not defined.**]

Privilege	Privilege Code	Privilege Type	Object Types	Screen Criteria
Liquidity Transfer Order Link Set Query	DCQ_ Liquid Trans OrderLink SetQuery	System	Party	n/a
Delete Liquidity Transfer Order Link Set	DCA_ Delete Liquidity TranOrd erLinkSet	System	n/a	<i>Delete</i> button

6.4.3.190 Standing/Predefined Liquidity Transfer Orders - Search/List Screen

△ [▶ **Error! Bookmark not defined.**]

Privilege	Privilege Code	Privilege Type	Object Types	Screen Criteria
Liquidity Transfer Order List Query	DCQ_LiquidTransOrderListQuery	Object	T2S Dedicated Account	n/a
Delete Liquidity Transfer Order	DCA_DeleteLiquidityTransferOrder	Object	T2S Dedicated Cash Account	Delete button
Liquidity Transfer Order Detail Query	DCQ_LiquidTransOrderDetailQuery	Object	T2S Dedicated Account	n/a
Liquidity Transfer Order of Liquidity Transfer Order Link Set Query	SDQ_LiqTranOrdOfLiqTranOrdLinkSetQ	System	n/a	n/a

6.4.3.191 Static Data Revisions - Search/List Screen

△ [▶ Error! Bookmark not defined.]

Privilege	Privilege Code	Privilege Type	Object Types	Screen Criteria
Party Audit Trail Query	PDQ_PartyAuditTrailQuery	Object	Party	Object Type = Party
Securities Audit Trail Query	SEQ_SecuritiesAuditTrailQuery	Object	Securities	Object Type = Securities

Privilege	Privilege Code	Privilege Type	Object Types	Screen Criteria
Securities Account Audit Trail Query	SAQ_SecuritiesAccAudTrailQuery	Object	Securities Account	Object Type = Securities Account
T2S Dedicated Cash Account Audit Trail Query	DCQ_T2SDedicCashAccAudTrailQuery	Object	T2S Dedicated Cash Account	Object Type = T2S Dedicated Cash Account
Residual Static Data Audit Trail Query	SDQ_ResidualStaticDataAudTrailQuery	System	n/a	Object Type = Party, T2S Dedicated Cash Account, Securities, Securities Account

6.4.3.192 Status History - Details Screen

△ [▶ **Error! Bookmark not defined.**]

No privileges.

6.4.3.193 System Entities - Search/List Screen

△ [▶ **Error! Bookmark not defined.**]

Privilege	Privilege Code	Privilege Type	Object Types	Screen Criteria
System Entity Query	SDQ_SystemEntityQuery	System	n/a	n/a

6.4.3.194 T2S BIC Directory Items - Search/List Screen

△ [▶ **Error! Bookmark not defined.**]

Privilege	Privilege Code	Privilege Type	Object Types	Screen Criteria
T2S BIC Query	NCQ_ T2SBIC Query	System	n/a	n/a

~~6.4.3.195 T2S Calendar~~

~~△ [▶ 47]~~

Privilege	Privilege Code	Privilege Type	Object Types	Screen Criteria
T2S Calendar Query	SCQ_ T2SCalen darQuery	System	n/a	n/a

6.4.3.196 T2S DCA Balance - Details Screen

△ [▶ **Error! Bookmark not defined.**]

No privileges.

6.4.3.197 T2S DCA Balances - Search/List Screen

△ [▶ **Error! Bookmark not defined.**]

Privilege	Privilege Code	Privilege Type	Object Types	Screen Criteria
T2S Dedicated Cash Account Balance Query	DDQ_ T2SDedi cated CashAcc Balance Query	Object	T2S Dedicat- ed Cash Ac- count	n/a

6.4.3.198 T2S DCA Postings - Search/List Screen

△ [▶ **Error! Bookmark not defined.**]

Privilege	Privilege Code	Privilege Type	Object Types	Screen Criteria
T2S Dedicated Cash	DDQ_	Object	T2S Dedicat-	n/a

Privilege	Privilege Code	Privilege Type	Object Types	Screen Criteria
Account Posting Query	T2S Dedicated CashAcc Posting Query		ed Cash Account	

6.4.3.199 T2S Dedicated Cash Account - Details Screen

△ [▶ **Error! Bookmark not defined.**]

Privilege	Privilege Code	Privilege Type	Object Types	Screen Criteria
T2S Dedicated Cash Account Reference Data Query	DCQ_ T2SDedic CashAcc ReferData Query	Object	T2S Dedicated Cash Account	n/a
Delete T2S Dedicated Cash Account	DCA_ Delete T2SDedicat ed Cash Account	Object	T2S Dedicated Cash Account	Delete button

6.4.3.200 T2S Dedicated Cash Account - New/Edit Screen

△ [▶ **Error! Bookmark not defined.**]

Privilege	Privilege Code	Privilege Type	Object Types	Screen Criteria
Create T2S Dedicated Cash Account	DCA_ Create T2SDedic atedCash Account	Object	Party	New mode
Update T2S Dedicated	DCA_	Object	T2S Dedicat-	Edit mode

Privilege	Privilege Code	Privilege Type	Object Types	Screen Criteria
Cash Account	Update T2SDedicatedCash Account		ed Cash Account	

6.4.3.201 T2S Dedicated Cash Accounts - Search/List Screen

△ [▶ **Error! Bookmark not defined.**]

Privilege	Privilege Code	Privilege Type	Object Types	Screen Criteria
T2S Dedicated Cash Account List Query	DCQ_T2SDedicatedCashAccListQuery	Object	T2S Dedicated Cash Account	n/a
Delete T2S Dedicated Cash Account	DCA_DeleteT2SDedicatedCashAccount	Object	T2S Dedicated Cash Account	Delete button
T2S Dedicated Cash Account Reference Data Query	DCQ_T2SDedic-CashAccRefer-DataQuery	Object	T2S Dedicated Cash Account	Details Button

6.4.3.202 Technical Addresses Network Services Link - Details Screen

△ [▶ **Error! Bookmark not defined.**]

Privilege	Privilege Code	Privilege Type	Object Types	Screen Criteria
Technical Address Network Service Link	NCQ_Display	System	n/a	n/a

Privilege	Privilege Code	Privilege Type	Object Types	Screen Criteria
Details Query	TechAddressNetSerLink			

6.4.3.203 Technical Addresses Network Services Link - New/Edit Screen

△ [▶ **Error! Bookmark not defined.**]

Privilege	Privilege Code	Privilege Type	Object Types	Screen Criteria
Create Technical Address Network Service Link	NCO_CreateTechnAddressNetServLink	System	n/a	New mode
Delete Technical Address Network Service Link	NCO_DeleteTechnAddressNetServLink	System	n/a	Delete button

6.4.3.204 Tolerance Amounts - Search/List Screen

△ [▶ **Error! Bookmark not defined.**]

Privilege	Privilege Code	Privilege Type	Object Types	Screen Criteria
Tolerance Amount Query	SDQ_ToleranceAmountQuery	System	n/a	n/a

6.4.3.205 Total Amount of Standing/Predefined Liquidity Transfer Orders - Search/List Screen

△ [▶ **Error! Bookmark not defined.**]

Total Collateral Value per T2S Dedicated Cash Account - Search/List Screen

Privilege	Privilege Code	Privilege Type	Object Types	Screen Criteria
Total Amount of Standing and Predefined Orders Query	DCQ_ TotAmountStand+ Predef OrdQuery	Object	T2S Dedicated Account	n/a

6.4.3.206 Total Collateral Value per T2S Dedicated Cash Account - Search/List Screen

△ [▶ **Error! Bookmark not defined.**]

Privilege	Privilege Code	Privilege Type	Object Types	Screen Criteria
Total Collateral Value per T2S Dedicated Cash Account Query	DDQ_ TotalCollatValue PerT2S DCA Query	System	n/a	n/a

6.4.3.207 User - Details Screen

△ [▶ **Error! Bookmark not defined.**]

Privilege	Privilege Code	Privilege Type	Object Types	Screen Criteria
T2S System User Query (T2S Actor Query)	ARQ_ T2SSys UserQueryT2S Actor Query	System	n/a	n/a
Delete User	ARM_ Delete User	System	n/a	Delete button

6.4.3.208 User - New/Edit Screen

△ [▶ **Error! Bookmark not defined.**]

Privilege	Privilege Code	Privilege Type	Object Types	Screen Criteria
Create User	ARM_ Create User	System	n/a	New mode
Update User	ARM_ Update User	System	n/a	Edit mode

6.4.3.209 User Access Rights - List Screen

△ [▶ 50]

Privilege	Privilege Code	Privilege Type	Object Types	Screen Criteria
Access Rights Query	ARQ_ Access Rights Query	System	n/a	n/a

6.4.3.210 User Access Rights - Search Screen

△ [▶ 50]

Privilege	Privilege Code	Privilege Type	Object Types	Screen Criteria
Access Rights Query	ARQ_ Access Rights Query	System	n/a	n/a

6.4.3.211 User Certificate Distinguished Name Link - New Screen

△ [▶ **Error! Bookmark not defined.**]

Privilege	Privilege Code	Privilege Type	Object Types	Screen Criteria
Create User Certificate Distinguish Name Link	ARM_ Create	System	n/a	New mode

User Certificate Distinguished Name Links - Search/List Screen

Privilege	Privilege Code	Privilege Type	Object Types	Screen Criteria
	User Certificate DNLink			

6.4.3.212 User Certificate Distinguished Name Links - Search/List Screen

△ [▶ **Error! Bookmark not defined.**]

Privilege	Privilege Code	Privilege Type	Object Types	Screen Criteria
Delete User Certificate Distinguish Name Link	ARM_DeleteUserCertificateDNLink	System	n/a	Delete button
T2S System User Link Query	ARQ_UserCertificateDNLinkQuery	System	n/a	n/a

6.4.3.213 Users - Search/List Screen

△ [▶ **Error! Bookmark not defined.**]

Privilege	Privilege Code	Privilege Type	Object Types	Screen Criteria
T2S System User Query (T2S Actor Query)	ARQ_T2SSysUserQueryT2SActorQuery	System	n/a	n/a
Delete User	ARM_DeleteUser	System	n/a	Delete button

6.4.3.214 Working/Closing Days - Search/List Screen

△ [▶ **Error! Bookmark not defined.**]

Privilege	Privilege Code	Privilege Type	Object Types	Screen Criteria
Closing Day Query	SCQ_ClosingDayQuery	System	n/a	n/a

6.4.4 Privilege Classes for LTSI Screens

Class of Privileges	Privilege Name	Privilege Short Name
Other	Long Term Statistical Information – Advanced User	ARM_GrantPrivilege
Other	Long Term Statistical Information Access	LTSI Access

6.4.5 Privileges for LTSI Screens

LTSI user profiles are created based on the Static data Privileges (which can only be 'LTSI Access' or 'LTSI Advanced', as mentioned in part 6.3.4), and also on the Party identifiers, stored in Static Data Users, and their party types associated. LTSI can also provide access to internal users, not sent by Static Data.

Possible LTSI privileges can be:

- | NCB end user: Static Data Party type= NCB, Static Data privilege='LTSI access', GFS user profile: Basic Statistical User
- | CSD end user: Static Data Party type= CSD, Static Data privilege='LTSI access', GFS user profile: Basic Statistical User
- | CSD participant end user: Static Data Party type= CSD, Static Data privilege='LTSI access', GFS user profile: Basic Statistical User
- | External CSD end user: Static Data Party type= External CSD, Static Data privilege='LTSI access', GFS user profile: Basic Statistical User
- | NCB analyst: Static Data Party type=NCB, Static Data privilege= 'LTSI advanced' and eventually also 'LTSI access', GFS user profile: Basic Statistical User and Advanced Statistical User
- | CSD analyst: Static Data Party type=CSD, Static Data privilege= 'LTSI advanced' and eventually also 'LTSI access', GFS user profile: Basic Statistical User and Advanced Statistical User
- | LTSI super user: Not sent by Static Data, Internal user, GFS user profile: Basic Statistical User and Advanced Statistical User

- | Administrator: Not sent by Static Data, Internal user, GFS user profile: Statistical Workspace administrator

The party type has an impact on the final LTSI privilege: for instance, a CSD Participant or external CSD can only be an end user, but not an analyst, and can have access only to business reports, but not to technical reports. Only NCB analysts and NCB end users can have access to reports on Liquidity Transfers, but not CSDs or CSD Participants or External CSD.

Each predefined report and query can be accessible only to a specific restricted list of LTSI privileges.

6.4.5.1 BSIQ.00 - Individual Settlement detailed Query – List Screen

△ [▶ **Error! Bookmark not defined.**]

Privileges
LTSI super user
NCB analyst
CSD analyst
NCB end user
CSD end user
CSD participant end user
External CSD end user

6.4.5.2 BSIQ.00 - Individual Settlement detailed Query – Search Screen

△ [▶ **Error! Bookmark not defined.**]

Privileges
LTSI super user
NCB analyst
CSD analyst
NCB end user

Privileges
CSD end user
CSD participant end user
External CSD end user

6.4.5.3 BSIQ.01 - Multi-criteria search of a set of Settlement Instructions - List Screen

△ [▶ **Error! Bookmark not defined.**]

Privileges
LTSI super user
NCB analyst
NCB end user
CSD analyst
CSD end user
CSD participant end user
External CSD end user

6.4.5.4 BSIQ.01 - Multi-criteria search of a set of Settlement Instructions - Search Screen

△ [▶ **Error! Bookmark not defined.**]

Privileges
LTSI super user
NCB analyst
NCB end user
CSD analyst
CSD end user
CSD participant end user
External CSD end user

6.4.5.5 BSIQ.02 - Individual Restriction detailed Query – List Screen

△ [▶ **Error! Bookmark not defined.**]

Privileges
LTSI super user
NCB analyst
CSD analyst
NCB end user
CSD end user
CSD participant end user
External CSD end user

6.4.5.6 BSIQ.02 - Individual Restriction detailed Query – Search Screen

△ [▶ **Error! Bookmark not defined.**]

Privileges
LTSI super user
NCB analyst
CSD analyst
NCB end user
CSD end user
CSD participant end user
External CSD end user

6.4.5.7 BSIQ.03 - Multi-criteria search of a set of Settlement Restrictions - List Screen

△ [▶ **Error! Bookmark not defined.**]

Privileges
LTSI super user
NCB analyst

Privileges
NCB end user
CSD analyst
CSD end user
CSD participant end user
External CSD end user

6.4.5.8 BSIQ.03 - Multi-criteria search of a set of Settlement Restrictions - Search Screen

△ [▶ **Error! Bookmark not defined.**]

Privileges
LTSI super user
NCB analyst
NCB end user
CSD analyst
CSD end user
CSD participant end user
External CSD end user

6.4.5.9 BSIQ.04 - Multi-criteria search of a set of Liquidity Transfers - List Screen

△ [▶ **Error! Bookmark not defined.**]

Privileges
LTSI super user
NCB analyst
NCB end user

6.4.5.10 BSIQ.04 - Multi-criteria search of a set of Liquidity Transfers - Search Screen

△ [▶ **Error! Bookmark not defined.**]

Privileges
LTSI super user
NCB analyst
NCB end user

6.4.5.11 BSIQ.05 - Multi-criteria search of a set of Business Cancellations - List Screen

△ [▶ **Error! Bookmark not defined.**]

Privileges
LTSI super user
NCB analyst
NCB end user
CSD analyst
CSD end user
CSD participant end user
External CSD end user

6.4.5.12 BSIQ.05 - Multi-criteria search of a set of Business Cancellations - Search Screen

△ [▶ **Error! Bookmark not defined.**]

Privileges
LTSI super user
NCB analyst
NCB end user
CSD analyst
CSD end user
CSD participant end user
External CSD end user

6.4.5.13 BSIQ.06 - Multi-criteria search of a set of Amendment Instructions – List Screen

△ [▶ **Error! Bookmark not defined.**]

Privileges
LTSI super user
NCB analyst
NCB end user
CSD analyst
CSD end user
CSD participant end user
External CSD end user

6.4.5.14 BSIQ.06 - Multi-criteria search of a set of Amendment Instructions - Search Screen

△ [▶ **Error! Bookmark not defined.**]

Privileges
LTSI super user
NCB analyst
NCB end user
CSD analyst
CSD end user
CSD participant end user
External CSD end user

6.4.5.15 BSIQ.07 - Multi-criteria search of a set of Hold and Release Instructions - List Screen

△ [▶ **Error! Bookmark not defined.**]

Privileges
LTSI super user
NCB analyst

Privileges
NCB end user
CSD analyst
CSD end user
CSD participant end user
External CSD end user

6.4.5.16 BSIQ.07 - Multi-criteria search of a set of Hold and Release Instructions - Search Screen

△ [▶ **Error! Bookmark not defined.**]

Privileges
LTSI super user
NCB analyst
NCB end user
CSD analyst
CSD end user
CSD participant end user
External CSD end user

6.4.5.17 BSIR.00 - T2SDCA: Finalised matched Instructions – List Screen

△ [▶ **Error! Bookmark not defined.**]

Privileges
LTSI super user
NCB analyst
NCB end user

6.4.5.18 BSIR.00 - T2SDCA: Finalised matched Instructions – Search Screen

△ [▶ **Error! Bookmark not defined.**]

Privileges
LTSI super user
NCB analyst
NCB end user

6.4.5.19 BSIR.01 - Securities Account: Finalised matched Instructions - List Screen

△ [▶ **Error! Bookmark not defined.**]

Privileges
LTSI super user
CSD analyst
CSD end user
CSD participant end user
External CSD end user

6.4.5.20 BSIR.01 - Securities Account: Finalised matched Instructions - Search Screen

△ [▶ **Error! Bookmark not defined.**]

Privileges
LTSI super user
CSD analyst
CSD end user
CSD participant end user
External CSD end user

6.4.5.21 BSIR.02 - T2SDCA: Detailed Finalised matched Settlement Instructions - List Screen

△ [▶ **Error! Bookmark not defined.**]

Privileges
LTSI super user
NCB analyst
NCB end user

6.4.5.22 BSIR.02 - T2SDCA: Detailed Finalised matched Settlement Instructions - Search Screen

△ [▶ **Error! Bookmark not defined.**]

Privileges
LTSI super user
NCB analyst
NCB end user

6.4.5.23 BSIR.03 - Securities Account: Detailed Finalised matched Settlement Instructions - List Screen

△ [▶ **Error! Bookmark not defined.**]

Privileges
LTSI super user
NCB analyst
NCB end user
CSD analyst
CSD end user
CSD participant end user
External CSD end user

6.4.5.24 BSIR.03 - Securities Account: Detailed Finalised matched Settlement Instructions - Search Screen

△ [▶ **Error! Bookmark not defined.**]

Privileges
LTSI super user
NCB analyst
CSD analyst
NCB end user
CSD end user
CSD participant end user
External CSD end user

6.4.5.25 BSIR.04 - T2SDCA: Follow-up by time slot of Settlement Activity - List Screen

△ [▶ **Error! Bookmark not defined.**]

Privileges
LTSI super user
NCB analyst
NCB end user

6.4.5.26 BSIR.04 - T2SDCA: Follow-up by time slot of Settlement Activity - Search Screen

△ [▶ **Error! Bookmark not defined.**]

Privileges
LTSI super user
NCB analyst
NCB end user

6.4.5.27 BSIR.05 - T2SDCA: Comparison of Settlement activity between two time periods - List Screen

△ [▶ **Error! Bookmark not defined.**]

BSIR.05 - T2SDCA: Comparison of Settlement activity between two time periods - Search Screen

Privileges
LTSI super user
NCB analyst
NCB end user

6.4.5.28 BSIR.05 - T2SDCA: Comparison of Settlement activity between two time periods - Search Screen

△ [▶ **Error! Bookmark not defined.**]

Privileges
LTSI super user
NCB analyst
NCB end user

6.4.5.29 CMBR.00 - Journaling of Limit Utilisations of Primary CMB - Search Screen

△ [▶ **Error! Bookmark not defined.**]

Privileges
LTSI super user
NCB analyst

6.4.5.30 CMBR.00 - Journaling of Limits Utilisations of Primary CMB - List Screen

△ [▶ **Error! Bookmark not defined.**]

Privileges
LTSI super user
NCB analyst

6.4.5.31 CMBR.01 - Journaling of Limits Utilisations of Secondary CMB - List Screen

△ [▶ **Error! Bookmark not defined.**]

Privileges
LTSI super user
NCB analyst

6.4.5.32 CMBR.01 - Journaling of Limits Utilisations of Secondary CMB - Search Screen

△ [▶ **Error! Bookmark not defined.**]

Privileges
LTSI super user
NCB analyst

6.4.5.33 COLL.00 - T2SDCA: Follow-up by time slot of Settled Collateralisation Instructions - List Screen

△ [▶ **Error! Bookmark not defined.**]

Privileges
LTSI super user
NCB analyst

6.4.5.34 COLL.00 - T2SDCA: Follow-up by time slot of Settled Collateralisation Instructions - Search Screen

△ [▶ **Error! Bookmark not defined.**]

Privileges
LTSI super user
NCB analyst

6.4.5.35 COLL.01 - Securities Accounts: Follow up by time slot of Settled Collateralisation Instructions - Search Screen

△ [▶ **Error! Bookmark not defined.**]

COLL.01 - Securities Accounts: Follow-up by time slot of Settled Collateralisation Instructions - List
Screen

Privileges
LTSI super user
CSD analyst

6.4.5.36 COLL.01 - Securities Accounts: Follow-up by time slot of Settled Collateralisation Instructions - List Screen

△ [▶ **Error! Bookmark not defined.**]

Privileges
LTSI super user
CSD analyst

6.4.5.37 COLL.02 - T2SDCA: Settled or Cancelled (automatic or manual) Collateralisation Instructions - List Screen

△ [▶ **Error! Bookmark not defined.**]

Privileges
LTSI super user
NCB analyst

6.4.5.38 COLL.02 - T2SDCA: Settled or Cancelled (automatic or manual) Collateralisation Instructions - Search Screen

△ [▶ **Error! Bookmark not defined.**]

Privileges
LTSI super user
NCB analyst

6.4.5.39 CPST.00 - T2SDCA: Follow-up by time slot of Cash Postings - List Screen

△ [▶ **Error! Bookmark not defined.**]

Privileges
LTSI super user
NCB analyst
NCB end user

6.4.5.40 CPST.00 - T2SDCA: Follow-up by time slot of Cash Postings - Search Screen

△ [▶ **Error! Bookmark not defined.**]

Privileges
LTSI super user
NCB analyst
NCB end user

6.4.5.41 LIQU.00 - Liquidity Transfers - List Screen

△ [▶ **Error! Bookmark not defined.**]

Privileges
LTSI super user
NCB analyst
NCB end user

6.4.5.42 LIQU.00 - Liquidity Transfers - Search Screen

△ [▶ **Error! Bookmark not defined.**]

Privileges
LTSI super user
NCB analyst
NCB end user

6.4.5.43 REAL.00 - Detailed Realignment and Other Technical Instructions - List Screen

△ [▶ **Error! Bookmark not defined.**]

Privileges
LTSI super user
CSD analyst

6.4.5.44 REAL.00 - Detailed Realignment and Other Technical Instructions - Search Screen

△ [▶ **Error! Bookmark not defined.**]

Privileges
LTSI super user
CSD analyst

6.4.5.45 REST.00 - Detailed Cash Restrictions - List Screen

△ [▶ **Error! Bookmark not defined.**]

Privileges
LTSI super user
NCB analyst
NCB end user

6.4.5.46 REST.00 - Detailed Cash Restrictions - Search Screen

△ [▶ **Error! Bookmark not defined.**]

Privileges
LTSI super user
NCB analyst
NCB end user

6.4.5.47 REST.01 - Detailed Securities Restrictions - Search Screen

△ [▶ **Error! Bookmark not defined.**]

Privileges
LTSI super user
CSD analyst
CSD end user
CSD Participant end user
External CSD end user

6.4.5.48 REST.01 - Detailed Securities Restrictions - List Screen

△ [▶ **Error! Bookmark not defined.**]

Privileges
LTSI super user
CSD analyst
CSD end user
CSD Participant end user
External CSD end user

6.4.5.49 SPST.00 - Securities Account: Follow-up by time schedule of Securities Postings - List Screen

△ [▶ **Error! Bookmark not defined.**]

Privileges
LTSI super user
NCB analyst
NCB end user
CSD analyst
CSD end user
CSD participant end user
External CSD end user

6.4.5.50 SPST.00 - Securities Account: Follow-up by time schedule of Securities Postings - Search Screen

△ [▶ **Error! Bookmark not defined.**]

Privileges
LTSI super user
NCB analyst
NCB end user
CSD analyst
CSD end user
CSD participant end user
External CSD end user

6.4.5.51 XREP.00 - T2SDCA: Matched Cancelled Instructions - List Screen

△ [▶ **Error! Bookmark not defined.**]

Privileges
LTSI super user
NCB analyst
NCB end user

6.4.5.52 XREP.00 - T2SDCA: Matched Cancelled Instructions - Search Screen

△ [▶ **Error! Bookmark not defined.**]

Privileges
LTSI super user
NCB analyst
NCB end user

6.4.5.53 XREP.01 - Securities Account: Matched Cancelled Instructions - List Screen

△ [▶ **Error! Bookmark not defined.**]

Privileges
LTSI super user
NCB analyst
CSD analyst
NCB end user
CSD end user
CSD participant end user
External CSD end user

6.4.5.54 XREP.01 - Securities Account: Matched Cancelled Instructions - Search Screen

△ [▶ **Error! Bookmark not defined.**]

Privileges
LTSI super user
CSD analyst
CSD end user
CSD Participant end user
External CSD end user

6.4.5.55 XREP.02 - Finalised Non Matched Cancellations - List Screen

△ [▶ **Error! Bookmark not defined.**]

Privileges
LTSI super user
CSD analyst
CSD end user
CSD Participant end user
External CSD end user

6.4.5.56 XREP.02 - Finalised Non Matched Cancellations - Search Screen

△ [▶ **Error! Bookmark not defined.**]

Privileges
LTSI super user
CSD analyst
CSD end user
CSD participant end user
External CSD end user

6.5 List of References for Error Messages

6.5.1 Reader's Guide

Reader's Guide

This section includes a list of references for error messages for all screens, structured along GUI screens, TMS screens and LTSI screens. For GUI screens, the list of references for error messages consists of a general section, which lists overall error codes that apply to all GUI screens, and a section listing all error codes relevant for using the 4-eyes mode in GUI screens. For all sections, these are followed by specific sections for individual screens, which are organised in alphabetical screen order and specify the respective error codes applicable for each screen. Each error code table entry includes the error text and the description.

6.5.2 References for Error Messages for GUI Screens

6.5.2.1 Security - New/Edit Screen

△ [▶ **Error! Bookmark not defined.**]

6.5.2.2 All

6.5.2.3 All Screens which allow the initiation of a query

6.5.2.4 All Screens which allow the initiation of a second user action (4-eyes mode)

6.5.2.5 Allegement Instruction - Details Screen

△ [▶ **Error! Bookmark not defined.**]

No references for error messages.

6.5.2.6 Allegement Instructions - Search/List Screen

△ [▶ **Error! Bookmark not defined.**]

6.5.2.7 Amendment Cash Instruction - Details Screen

△ [▶ **Error! Bookmark not defined.**]

No references for error messages.

6.5.2.8 Amendment Cash Instruction - New Screen

△ [▶ **Error! Bookmark not defined.**]

6.5.2.9 Amendment Securities Instruction - Details Screen

△ [▶ **Error! Bookmark not defined.**]

No references for error messages.

6.5.2.10 Amendment Securities Instruction - New Screen

△ [▶ **Error! Bookmark not defined.**]

6.5.2.11 Attribute Domain - Details Screen

△ [▶ **Error! Bookmark not defined.**]

6.5.2.12 Attribute Domain - New/Edit Screen

△ [▶ **Error! Bookmark not defined.**]

6.5.2.13 Attribute Domain Reference - Details Screen

△ [▶ **Error! Bookmark not defined.**]

6.5.2.14 Attribute Domain Reference - New/Edit Screen

△ [▶ **Error! Bookmark not defined.**]

6.5.2.15 Attribute Domain References - List Screen

△ [▶ **Error! Bookmark not defined.**]

6.5.2.16 Attribute Domains - Search/List Screen

△ [▶ **Error! Bookmark not defined.**]

6.5.2.17 Auto-Collateralisation Eligibility Link - New Screen

△ [▶ **Error! Bookmark not defined.**]

6.5.2.18 Auto-Collateralisation Eligibility Links - Search/List Screen

△ [▶ **Error! Bookmark not defined.**]

6.5.2.19 Available Report - Current Settlement Day Cash Information (Following Settlement Day Cash Forecast) Report – Details Screen

△ [▶ **Error! Bookmark not defined.**]

No references for error messages.

6.5.2.20 Available Report - Details Screen

△ [▶ **Error! Bookmark not defined.**]

No references for error messages.

6.5.2.21 Available Report - Statement of Accounts - Details Screen

△ [▶ **Error! Bookmark not defined.**]

No references for error messages.

6.5.2.22 Available Report - Statement of Executed Amendment Instructions for Intra-Balance Movements - Details Screen

△ [▶ **Error! Bookmark not defined.**]

No references for error messages.

6.5.2.23 Available Report - Statement of Executed Amendment Instructions for Intra-Position Movements and Settlement Instructions - Details Screen

△ [▶ **Error! Bookmark not defined.**]

No references for error messages.

6.5.2.24 Available Report - Statement of Executed Cancellation Instructions for Intra-Balance Movements - Details Screen

△ [▶ **Error! Bookmark not defined.**]

No references for error messages.

6.5.2.25 Available Report - Statement of Executed Cancellation Instructions for Intra-Position Movements and Settlement Instructions - Details Screen

△ [▶ **Error! Bookmark not defined.**]

No references for error messages.

6.5.2.26 Available Report - Statement of Holdings - Details Screen

△ [▶ **Error! Bookmark not defined.**]

No references for error messages.

6.5.2.27 Available Report - Statement of Pending Amendment Instructions for Intra-Balance Movements - Details Screen

△ [▶ **Error! Bookmark not defined.**]

No references for error messages.

6.5.2.28 Available Report - Statement of Pending Amendment Instructions for Intra-Position Movements and Settlement Instructions - Details Screen

△ [▶ **Error! Bookmark not defined.**]

No references for error messages.

6.5.2.29 Available Report - Statement of Pending Cancellation Instructions for Intra-Balance Movements - Details Screen

△ [▶ **Error! Bookmark not defined.**]

No references for error messages.

6.5.2.30 Available Report - Statement of Pending Cancellation Instructions for Intra-Position Movements and Settlement Instructions - Details Screen

△ [▶ **Error! Bookmark not defined.**]

No references for error messages.

6.5.2.31 Available Report - Statement of Pending Instructions - Details Screen

△ [▶ **Error! Bookmark not defined.**]

No references for error messages.

6.5.2.32 Available Report - Statement of Pending Intra-Balance Movements - Details Screen

△ [▶ **Error! Bookmark not defined.**]

No references for error messages.

6.5.2.33 Available Report - Statement of Pending Intra-Position Movements - Details Screen

△ [▶ **Error! Bookmark not defined.**]

No references for error messages.

6.5.2.34 Available Report - Statement of Settled Intra-Balance Movements - Details Screen

△ [▶ **Error! Bookmark not defined.**]

No references for error messages.

6.5.2.35 Available Report - Statement of Settled Intra-Position Movements - Details Screen

△ [▶ **Error! Bookmark not defined.**]

No references for error messages.

6.5.2.36 Available Report - Statement of Settlement Allegements - Details Screen

△ [▶ **Error! Bookmark not defined.**]

No references for error messages.

6.5.2.37 Available Report - Statement of Static Data - Details Screen

△ [▶ **Error! Bookmark not defined.**]

No references for error messages.

6.5.2.38 Available Report - Statement of Transactions - Details Screen

△ [▶ **Error! Bookmark not defined.**]

No references for error messages.

6.5.2.39 Available Reports - Search/List Screen

△ [▶ 41]

6.5.2.40 Broadcast - Details Screen

△ [▶ **Error! Bookmark not defined.**]

No references for error messages.

6.5.2.41 Broadcast - New Screen

△ [▶ **Error! Bookmark not defined.**]

No references for error messages.

6.5.2.42 Broadcasts - Search/List Screen

△ [▶ 50]

6.5.2.43 Calendar - Search/List Screen

△ [▶ XXX]

No references for error messages.

6.5.2.44 Cancellation Cash Instruction - Details Screen

△ [▶ **Error! Bookmark not defined.**]

No references for error messages.

6.5.2.45 Cancellation Cash Instruction - New Screen

△ [▶ **Error! Bookmark not defined.**]

6.5.2.46 Cancellation Securities Instruction - Details Screen

△ [▶ **Error! Bookmark not defined.**]

No references for error messages.

6.5.2.47 Cancellation Securities Instruction - New Screen

△ [▶ **Error! Bookmark not defined.**]

6.5.2.48 Cash Forecast - Details Screen

△ [▶ **Error! Bookmark not defined.**]

No references for error messages.

6.5.2.49 Cash Forecasts - Search/List Screen

△ [▶ **Error! Bookmark not defined.**]

6.5.2.50 Cash Restriction Details - Search/List Screen

△ [▶ **Error! Bookmark not defined.**]

6.5.2.51 Certificate Distinguished Name - New Screen

△ [▶ **Error! Bookmark not defined.**]

6.5.2.52 Certificates Distinguished Names - Search/List Screen

△ [▶ **Error! Bookmark not defined.**]

6.5.2.53 Close Link - New Screen

△ [▶ **Error! Bookmark not defined.**]

6.5.2.54 Close Links - Search/List Screen

△ [▶ **Error! Bookmark not defined.**]

6.5.2.55 CMB - Details Screen

△ [▶ **Error! Bookmark not defined.**]

6.5.2.56 CMB - New/Edit Screen

△ [▶ **Error! Bookmark not defined.**]

6.5.2.57 CMBs - Search/List Screen

△ [▶ **Error! Bookmark not defined.**]

6.5.2.58 Collateral Value of a Security - Search/List Screen

△ [▶ **Error! Bookmark not defined.**]

6.5.2.59 Collateral Value per T2S Dedicated Cash Account and Security - Search/List Screen

△ [▶ **Error! Bookmark not defined.**]

6.5.2.60 CoSD Rule - New/Edit Screen

△ [▶ **Error! Bookmark not defined.**]

6.5.2.61 CoSD Rule Set - New/Edit Screen

△ [▶ **Error! Bookmark not defined.**]

6.5.2.62 CoSD Rule Sets - Search/List Screen

△ [▶ **Error! Bookmark not defined.**]

6.5.2.63 CoSD Rules - Search/List Screen

△ [▶ **Error! Bookmark not defined.**]

6.5.2.64 Countries - Search/List Screen

△ [▶ **Error! Bookmark not defined.**]

No references for error messages.

6.5.2.65 CSD Account Link - New/Edit Screen

△ [▶ **Error! Bookmark not defined.**]

6.5.2.66 CSD Account Links - Search/List Screen

△ [▶ **Error! Bookmark not defined.**]

6.5.2.67 Cumulative Billing Data - Details Screen

△ [▶ **Error! Bookmark not defined.**]

No references for error messages.

6.5.2.68 Cumulative Billing Data - Search/List Screen

△ [▶ **Error! Bookmark not defined.**]

6.5.2.69 Currencies - Search/List Screen

△ [▶ **Error! Bookmark not defined.**]

No references for error messages.

6.5.2.70 Daily Price – New/Edit Screen

△ [▶ **Error! Bookmark not defined.**]

6.5.2.71 Daily Price – Search/List Screen

△ [▶ **Error! Bookmark not defined.**]

~~6.5.2.72 Daily Schedules - Search/List Screen~~

~~△ [▶ 43]~~

Reference for error message	Field or Button	Error Text	Description
OSAC003	<ul style="list-style-type: none"> Event Type Description field Search button 	Invalid Event Type	The Event Type specified in a request for access to the business day schedule must be an existing event in the daily plan.
OSAC005	<ul style="list-style-type: none"> Search button 	Missing mandatory section/field	A request for access to the business day schedule must contain one and only one criteria specification.
OSAC006	<ul style="list-style-type: none"> Event Type Description field Search button 	No data available	In a request to access the current day schedule, the Event Type Code and Event Schedule Time (if specified) must be consistent and refer to an existing event occurrence in the daily schedule.
QMPC016	<ul style="list-style-type: none"> Date field Search button 	The Date From is older than three calendar months.	The Date From must not be older than three calendar months.

6.5.2.73 Data Change - Details Screen

△ [▶ 47]

No references for error messages.

6.5.2.74 Data Changes - Search/List Screen

△ [▶ 47]

6.5.2.75 Eligible Counterpart CSD - Details Screen

△ [▶ **Error! Bookmark not defined.**]

6.5.2.76 Eligible Counterpart CSD - New/Edit Screen

△ [▶ **Error! Bookmark not defined.**]

6.5.2.77 Eligible Counterpart CSDs - Search/List Screen

△ [▶ **Error! Bookmark not defined.**]

6.5.2.78 Euro Foreign Exchange Reference Rate - New/Edit Screen

△ [▶ **Error! Bookmark not defined.**]

6.5.2.79 Euro Foreign Exchange Reference Data - Search/List Screen

△ [▶ **Error! Bookmark not defined.**]

6.5.2.80 Event Type - Details Screen

△ [▶ **Error! Bookmark not defined.**]

No references for error messages.

6.5.2.81 Event Types - Search/List Screen

△ [▶ **Error! Bookmark not defined.**]

6.5.2.82 External RTGS Account - Details Screen

△ [▶ **Error! Bookmark not defined.**]

6.5.2.83 External RTGS Account - New/Edit Screen

△ [▶ **Error! Bookmark not defined.**]

6.5.2.84 External RTGS Accounts - Search/List Screen

△ [▶ **Error! Bookmark not defined.**]

6.5.2.85 Grant/Revoke Cross-System Entity Object Privilege - Details Screen

△ [▶ **Error! Bookmark not defined.**]

No reference for error messages.

6.5.2.86 Grant/Revoke Cross-System Entity Object Privilege - New/Edit Screen

△ [▶ **Error! Bookmark not defined.**]

6.5.2.87 Grant/Revoke Object Privilege - Details Screen

△ [▶ **Error! Bookmark not defined.**]

No references for error messages.

6.5.2.88 Grant/Revoke Object Privilege - New/Edit Screen

△ [▶ **Error! Bookmark not defined.**]

6.5.2.89 Grant/Revoke Privileges - Search Screen

△ [▶ **Error! Bookmark not defined.**]

6.5.2.90 Grant/Revoke Role - Details Screen

△ [▶ **Error! Bookmark not defined.**]

No references for error messages.

6.5.2.91 Grant/Revoke Role - New/Edit Screen

△ [▶ **Error! Bookmark not defined.**]

6.5.2.92 Grant/Revoke System Privilege - Details Screen

△ [▶ **Error! Bookmark not defined.**]

No references for error messages.

6.5.2.93 Grant/Revoke System Privilege - New/Edit Screen

△ [▶ **Error! Bookmark not defined.**]

6.5.2.94 Granted Roles - Search/List Screen

△ [▶ **Error! Bookmark not defined.**]

No references for error messages.

6.5.2.95 Hold/Release Instruction - Details Screen

△ [▶ **Error! Bookmark not defined.**]

No references for error messages.

6.5.2.96 Hold/Release Instruction - New Screen

△ [▶ **Error! Bookmark not defined.**]

6.5.2.97 Immediate Liquidity Transfer Order - Details Screen

△ [▶ **Error! Bookmark not defined.**]

No references for error messages.

6.5.2.98 Immediate Liquidity Transfer Order - New Screen

△ [▶ **Error! Bookmark not defined.**]

6.5.2.99 Immediate Liquidity Transfer Orders - Search/List Screen

△ [▶ **Error! Bookmark not defined.**]

6.5.2.100 Inbound File - Details Screen

△ [▶ **Error! Bookmark not defined.**]

No references for error messages.

6.5.2.101 Inbound Files - Search/List Screen

△ [▶ **Error! Bookmark not defined.**]

6.5.2.102 Inbound Message - Details Screen

△ [▶ **Error! Bookmark not defined.**]

No references for error messages.

6.5.2.103 Inbound Messages - Search/List Screen

△ [▶ **Error! Bookmark not defined.**]

6.5.2.104 Insolvency procedure Settlement Instructions - Search/List Screen

△ [▶ **Error! Bookmark not defined.**]

6.5.2.105 Intra-Balance Movement - Details Screen

△ [▶ **Error! Bookmark not defined.**]

No references for error messages.

6.5.2.106 Intra-Balance Movement - New Screen

△ [▶ **Error! Bookmark not defined.**]

6.5.2.107 Intra-Balance Movements - Search/List Screen

△ [▶ **Error! Bookmark not defined.**]

6.5.2.108 Intra-Position Movement - Details Screen

△ [▶ **Error! Bookmark not defined.**]

No references for error messages.

6.5.2.109 Intra-Position Movement - New Screen

△ [▶ **Error! Bookmark not defined.**]

6.5.2.110 Intra-Position Movements - Search/List Screen

△ [▶ **Error! Bookmark not defined.**]

6.5.2.111 Itemised Billing Data - Details Screen

△ [▶ 47]

No references for error messages.

6.5.2.112 Itemised Billing Data - Search/List Screen

△ [▶ 47]

6.5.2.113 Limit - New/Edit Screen

△ [▶ **Error! Bookmark not defined.**]

6.5.2.114 Limit Utilisation - Search/List Screen

△ [▶ **Error! Bookmark not defined.**]

6.5.2.115 Limit Utilisation Journal - Search/List Screen

△ [▶ **Error! Bookmark not defined.**]

6.5.2.116 Limits - Search/List Screen

△ [▶ **Error! Bookmark not defined.**]

6.5.2.117 Maintenance Cash Instructions – Search/List Screen

△ [▶ **Error! Bookmark not defined.**]

6.5.2.118 Maintenance Securities Instructions - Search/List Screen

△ [▶ **Error! Bookmark not defined.**]

6.5.2.119 Market-Specific Attribute - Details Screen

△ [▶ **Error! Bookmark not defined.**]

6.5.2.120 Market-Specific Attribute - New/Edit Screen

△ [▶ **Error! Bookmark not defined.**]

6.5.2.121 Market-Specific Attributes - Search/List Screen

△ [▶ **Error! Bookmark not defined.**]

6.5.2.122 Message Subscription Rule - New/Edit Screen

△ [▶ **Error! Bookmark not defined.**]

6.5.2.123 Message Subscription Rule Set - Details Screen

△ [▶ **Error! Bookmark not defined.**]

6.5.2.124 Message Subscription Rule Set - New/Edit Screen

△ [▶ **Error! Bookmark not defined.**]

6.5.2.125 Message Subscription Rule Sets - Search/List Screen

△ [▶ **Error! Bookmark not defined.**]

6.5.2.126 Message Subscription Rules - List Screen

△ [▶ **Error! Bookmark not defined.**]

6.5.2.127 Network Services - Search/List Screen

△ [▶ **Error! Bookmark not defined.**]

No references for error messages.

6.5.2.128 Outbound File - Details Screen

△ [▶ **Error! Bookmark not defined.**]

6.5.2.129 Outbound Files - Search/List Screen

△ [▶ **Error! Bookmark not defined.**]

6.5.2.130 Outbound Message - Details Screen

△ [▶ **Error! Bookmark not defined.**]

6.5.2.131 Outbound Messages - Search/List Screen

△ [▶ **Error! Bookmark not defined.**]

6.5.2.132 Outstanding Auto-Collateralisation Credits - Search/List Screen

△ [▶ **Error! Bookmark not defined.**]

6.5.2.133 Overall Liquidity - Search/List Screen

△ [▶ **Error! Bookmark not defined.**]

6.5.2.134 Partial Settlement Thresholds - Search/List Screen

△ [▶ **Error! Bookmark not defined.**]

No references for error messages.

6.5.2.135 Parties - Search/List Screen

△ [▶ **Error! Bookmark not defined.**]

6.5.2.136 Party - Details Screen

△ [▶ **Error! Bookmark not defined.**]

6.5.2.137 Party - New/Edit Screen

△ [▶ **Error! Bookmark not defined.**]

6.5.2.138 Penalty - Details Screen

△ [▶ **Error! Bookmark not defined.**]

6.5.2.139 Penalty - Re-allocation Screen

△ [▶ **Error! Bookmark not defined.**]

6.5.2.140 Penalty – Removal Screen

△ [▶ **Error! Bookmark not defined.**]

6.5.2.141 Penalty - Switch Screen

△ [▶ **Error! Bookmark not defined.**]

6.5.2.142 Privileges - Search/List Screen

△ [▶ **Error! Bookmark not defined.**]

6.5.2.143 Queued Static Data Change – Details Screen

△ [▶ 47]

No references for error messages.

6.5.2.144 Queued Static Data Changes – Search/List Screen

△ [▶ 47]

No references for error messages.

6.5.2.145 Report Configuration - Details Screen

△ [▶ **Error! Bookmark not defined.**]

6.5.2.146 Report Configuration - New/Edit Screen

△ [▶ **Error! Bookmark not defined.**]

6.5.2.147 Report Configurations - Search/List Screen

△ [▶ **Error! Bookmark not defined.**]

6.5.2.148 Resend Communication Screen

△ [▶ **Error! Bookmark not defined.**]

6.5.2.149 Restricted Parties - Search/List Screen

△ [▶ **Error! Bookmark not defined.**]

6.5.2.150 Restriction Type - New/Edit Screen

△ [▶ **Error! Bookmark not defined.**]

6.5.2.151 Restriction Type Rule - Details Screen

△ [▶ **Error! Bookmark not defined.**]

6.5.2.152 Restriction Type Rule - New/Edit Screen

△ [▶ **Error! Bookmark not defined.**]

6.5.2.153 Restriction Type Rule Sets - List Screen

△ [▶ **Error! Bookmark not defined.**]

6.5.2.154 Restriction Types - Search/List Screen

△ [▶ **Error! Bookmark not defined.**]

6.5.2.155 Revisions/Audit Trail - Details Screen

△ [▶ **Error! Bookmark not defined.**]

No references for error messages.

6.5.2.156 Revisions/Audit Trail - List Screen

△ [▶ **Error! Bookmark not defined.**]

No references for error messages.

6.5.2.157 Role - New/Edit Screen

△ [▶ **Error! Bookmark not defined.**]

6.5.2.158 Roles - Search/List Screen

△ [▶ **Error! Bookmark not defined.**]

6.5.2.159 Routing - New/Edit Screen

△ [▶ **Error! Bookmark not defined.**]

6.5.2.160 Routings - Search/List Screen

△ [▶ **Error! Bookmark not defined.**]

6.5.2.161 Secured Group - Details Screen

△ [▶ **Error! Bookmark not defined.**]

6.5.2.162 Secured Group - New/Edit Screen

△ [▶ **Error! Bookmark not defined.**]

6.5.2.163 Secured Groups - Search/List Screen

△ [▶ **Error! Bookmark not defined.**]

6.5.2.164 Securities - Search/List Screen

△ [▶ **Error! Bookmark not defined.**]

6.5.2.165 Securities Account - Details Screen

△ [▶ **Error! Bookmark not defined.**]

6.5.2.166 Securities Account - New/Edit Screen

△ [▶ **Error! Bookmark not defined.**]

6.5.2.167 Securities Account Transfer Management - Edit Screen

△ [▶ **Error! Bookmark not defined.**]

6.5.2.168 Securities Accounts - Search/List Screen

△ [▶ **Error! Bookmark not defined.**]

6.5.2.169 Securities Accounts Link - New/Edit Screen

△ [▶ **Error! Bookmark not defined.**]

6.5.2.170 Securities Accounts Links – Search/List Screen

△ [▶ **Error! Bookmark not defined.**]

6.5.2.171 Securities Position - Details Screen

△ [▶ **Error! Bookmark not defined.**]

No references for error messages.

6.5.2.172 Securities Positions - Search/List Screen

△ [▶ **Error! Bookmark not defined.**]

6.5.2.173 Securities Postings - Search/List Screen

△ [▶ **Error! Bookmark not defined.**]

6.5.2.174 Securities Restriction Details - Search/List Screen

△ [▶ **Error! Bookmark not defined.**]

6.5.2.175 Securities Subject to Cash Penalties - New/Edit Screen

△ [▶ **Error! Bookmark not defined.**]

6.5.2.176 Securities Subject to Cash Penalties - Search/List Screen

△ [▶ **Error! Bookmark not defined.**]

6.5.2.177 Securities Valuation - New Screen

△ [▶ **Error! Bookmark not defined.**]

6.5.2.178 Securities Valuations - Search/List Screen

△ [▶ **Error! Bookmark not defined.**]

6.5.2.179 Security - Details Screen

△ [▶ **Error! Bookmark not defined.**]

6.5.2.180 Security CSD Link - Details Screen

△ [▶ **Error! Bookmark not defined.**]

6.5.2.181 Security CSD Link - New/Edit Screen

△ [▶ **Error! Bookmark not defined.**]

6.5.2.182 Security CSD Links - Search/List Screen

△ [▶ **Error! Bookmark not defined.**]

6.5.2.183 Service Item - Details Screen

△ [▶ **Error! Bookmark not defined.**]

6.5.2.184 Service Items - Search/List Screen

△ [▶ **Error! Bookmark not defined.**]

No references for error messages.

6.5.2.185 Settlement Days - Search/List Screen

△ [▶ XXX]

Reference for error message	Field or Button	Error Text	Description
OSAC003	Event Type field Search button	Invalid Event Type	The Event Type specified in a request for access to the business day schedule must be an existing event in the daily plan.
OSAC005	Search button	Missing mandatory section/field	A request for access to the business day schedule must contain one and only one criteria specification.
OSAC006	Event Type field Search button	No data available	In a request to access the current day schedule, the Event Type Code and Event Schedule Time (if specified) must be consistent and refer to an existing event occurrence in the daily schedule.

6.5.2.186

6.5.2.187 Settlement Instruction - Details Screen

△ [▶ **Error! Bookmark not defined.**]

No references for error messages.

6.5.2.188 Settlement Instruction - New Screen

△ [▶ **Error! Bookmark not defined.**]

6.5.2.189 Settlement Instruction - Search/List Screen

△ [▶ **Error! Bookmark not defined.**]

6.5.2.190 Standing/Predefined Liquidity Transfer Order - Details Screen

△ [▶ **Error! Bookmark not defined.**]

6.5.2.191 Standing/Predefined Liquidity Transfer Order - New/Edit Screen

△ [▶ **Error! Bookmark not defined.**]

6.5.2.192 Standing/Predefined Liquidity Transfer Order Link Set - Details Screen

△ [▶ **Error! Bookmark not defined.**]

6.5.2.193 Standing/Predefined Liquidity Transfer Order Link Set - New/Edit Screen

△ [▶ **Error! Bookmark not defined.**]

6.5.2.194 Standing/Predefined Liquidity Transfer Order Link Sets - Search/List Screen

△ [▶ **Error! Bookmark not defined.**]

6.5.2.195 Standing/Predefined Liquidity Transfer Orders - Search/List Screen

△ [▶ **Error! Bookmark not defined.**]

6.5.2.196 Static Data Revisions - Search/List Screen

△ [▶ **Error! Bookmark not defined.**]

6.5.2.197 Status History - Details Screen

△ [▶ **Error! Bookmark not defined.**]

No references for error messages.

6.5.2.198 System Entities - Search/List Screen

△ [▶ **Error! Bookmark not defined.**]

No reference for error messages.

6.5.2.199 T2S BIC Directory Items - Search/List Screen

△ [▶ **Error! Bookmark not defined.**]

~~6.5.2.200 T2S Calendar~~

~~△ [▶ 47]~~

~~No references for error messages.~~

6.5.2.201 T2S DCA Balance - Details Screen

△ [▶ **Error! Bookmark not defined.**]

No references for error messages.

6.5.2.202 T2S DCA Balances - Search/List Screen

△ [▶ **Error! Bookmark not defined.**]

6.5.2.203 T2S DCA Postings - Search/List Screen

△ [▶ **Error! Bookmark not defined.**]

6.5.2.204 T2S Dedicated Cash Account - Details Screen

△ [▶ **Error! Bookmark not defined.**]

6.5.2.205 T2S Dedicated Cash Account - New/Edit Screen

△ [▶ **Error! Bookmark not defined.**]

6.5.2.206 T2S Dedicated Cash Accounts - Search/List Screen

△ [▶ **Error! Bookmark not defined.**]

6.5.2.207 Technical Addresses Network Services Link - Details Screen

△ [▶ **Error! Bookmark not defined.**]

No references for error messages.

6.5.2.208 Technical Addresses Network Services Link - New/Edit Screen

△ [▶ **Error! Bookmark not defined.**]

6.5.2.209 Tolerance Amounts - Search/List Screen

△ [▶ **Error! Bookmark not defined.**]

No references for error messages.

6.5.2.210 Total Amount of Standing/Predefined Liquidity Transfer Orders - Search/List Screen

△ [▶ **Error! Bookmark not defined.**]

6.5.2.211 Total Collateral Value per T2S Dedicated Cash Account - Search/List Screen

△ [▶ **Error! Bookmark not defined.**]

6.5.2.212 User - Details Screen

△ [▶ **Error! Bookmark not defined.**]

6.5.2.213 User - New/Edit Screen

△ [▶ **Error! Bookmark not defined.**]

6.5.2.214 User Access Rights - List Screen

△ [▶ 50]

No reference for error messages.

6.5.2.215 User Access Rights - Search Screen

△ [▶ 50]

No reference for error messages.

6.5.2.216 User Certificate Distinguished Name Link - New Screen

△ [▶ **Error! Bookmark not defined.**]

6.5.2.217 User Certificate Distinguished Name Links - Search/List Screen

△ [▶ **Error! Bookmark not defined.**]

6.5.2.218 Users - Search/List Screen

△ [▶ **Error! Bookmark not defined.**]

6.5.2.219 Working/Closing Days - Search/List Screen

△ [▶ **Error! Bookmark not defined.**]

No reference for error messages.

6.5.2.220 Dedicated Cash Account – New/Edit Screen

6.5.3 References for Error Messages for TMS Screens

6.5.3.1 Trouble Case - Search/List Screen

△ [▶ **Error! Bookmark not defined.**]

6.5.3.2 Trouble Case - Details Screen

△ [▶ **Error! Bookmark not defined.**]

No references for error messages.

6.5.3.3 Trouble Case - Export Screen

△ [▶ **Error! Bookmark not defined.**]

6.5.4 References for Error Messages for LTSI Screens

6.5.4.1 BSIQ.00 - Individual Settlement detailed Query – List Screen

△ [▶ **Error! Bookmark not defined.**]

No references for error messages.

6.5.4.2 BSIQ.00 - Individual Settlement detailed Query – Search Screen

△ [▶ **Error! Bookmark not defined.**]

No references for error messages.

6.5.4.3 BSIQ.01 - Multi-criteria search of a set of Settlement Instructions - List Screen

△ [▶ **Error! Bookmark not defined.**]

No references for error messages.

6.5.4.4 BSIQ.01 - Multi-criteria search of a set of Settlement Instructions - Search Screen

△ [▶ **Error! Bookmark not defined.**]

6.5.4.5 BSIQ.02 - Individual Restriction detailed Query – List Screen

△ [▶ **Error! Bookmark not defined.**]

No references for error messages.

6.5.4.6 BSIQ.02 - Individual Restriction detailed Query – Search Screen

△ [▶ **Error! Bookmark not defined.**]

No references for error messages.

6.5.4.7 BSIQ.03 - Multi-criteria search of a set of Settlement Restrictions - List Screen

△ [▶ **Error! Bookmark not defined.**]

No references for error messages.

6.5.4.8 BSIQ.03 - Multi-criteria search of a set of Settlement Restrictions - Search Screen

△ [▶ **Error! Bookmark not defined.**]

6.5.4.9 BSIQ.04 - Multi-criteria search of a set of Liquidity Transfers - List Screen

△ [▶ **Error! Bookmark not defined.**]

No references for error messages.

6.5.4.10 BSIQ.04 - Multi-criteria search of a set of Liquidity Transfers - Search Screen

△ [▶ **Error! Bookmark not defined.**]

6.5.4.11 BSIQ.05 - Multi-criteria search of a set of Business Cancellations - List Screen

△ [▶ **Error! Bookmark not defined.**]

No references for error messages.

6.5.4.12 BSIQ.05 - Multi-criteria search of a set of Business Cancellations - Search Screen

△ [▶ **Error! Bookmark not defined.**]

6.5.4.13 BSIQ.06 - Multi-criteria search of a set of Amendment Instructions - List Screen

△ [▶ **Error! Bookmark not defined.**]

No references for error messages.

6.5.4.14 BSIQ.06 - Multi-criteria search of a set of Amendment Instructions - Search Screen

△ [▶ **Error! Bookmark not defined.**]

6.5.4.15 BSIQ.07 - Multi-criteria search of a set of Hold and Release Instructions - List Screen

△ [▶ **Error! Bookmark not defined.**]

No references for error messages.

6.5.4.16 BSIQ.07 - Multi-criteria search of a set of Hold and Release Instructions - Search Screen

△ [▶ **Error! Bookmark not defined.**]

6.5.4.17 BSIR.00 - T2SDCA: Finalised Matched Instructions – List Screen

△ [▶ **Error! Bookmark not defined.**]

No references for error messages.

6.5.4.18 BSIR.00 - T2SDCA: Finalised Matched Instructions – Search Screen

△ [▶ **Error! Bookmark not defined.**]

6.5.4.19 BSIR.01 - Securities Account: Finalised Matched Instructions - List Screen

△ [▶ **Error! Bookmark not defined.**]

No references for error messages.

6.5.4.20 BSIR.01 - Securities Account: Finalised Matched Instructions - Search Screen

△ [▶ **Error! Bookmark not defined.**]

6.5.4.21 BSIR.02 - T2SDCA: Detailed Finalised Matched Settlement Instructions - List Screen

△ [▶ **Error! Bookmark not defined.**]

No references for error messages.

6.5.4.22 BSIR.02 - T2SDCA: Detailed Finalised Matched Settlement Instructions - Search Screen

△ [▶ **Error! Bookmark not defined.**]

6.5.4.23 BSIR.03 - Securities Account: Detailed Finalised Matched Settlement Instructions - List Screen

△ [▶ **Error! Bookmark not defined.**]

No references for error messages.

6.5.4.24 BSIR.03 - Securities Account: Detailed Finalised Matched Settlement Instructions - Search Screen

△ [▶ **Error! Bookmark not defined.**]

6.5.4.25 BSIR.04 - T2SDCA: Follow-up by time slot of Settlement Activity - List Screen

△ [▶ **Error! Bookmark not defined.**]

No references for error messages.

6.5.4.26 BSIR.04 - T2SDCA: Follow-up by time slot of Settlement Activity - Search Screen

△ [▶ **Error! Bookmark not defined.**]

6.5.4.27 BSIR.05 - T2SDCA: Comparison of Settlement activity between two time periods - List Screen

△ [▶ **Error! Bookmark not defined.**]

No references for error messages.

6.5.4.28 BSIR.05 - T2SDCA: Comparison of Settlement activity between two time periods - Search Screen

△ [▶ **Error! Bookmark not defined.**]

6.5.4.29 CMBR.00 - Journaling of Limits Utilisations of Primary CMB - List Screen

△ [▶ **Error! Bookmark not defined.**]

No references for error messages.

6.5.4.30 CMBR.00 - Journaling of Limits Utilisations of Primary CMB - Search Screen

△ [▶ **Error! Bookmark not defined.**]

6.5.4.31 CMBR.01 - Journaling of Limits Utilisations of Secondary CMB - List Screen

△ [▶ **Error! Bookmark not defined.**]

No references for error messages.

6.5.4.32 CMBR.01 - Journaling of Limits Utilisations of Secondary CMB - Search Screen

△ [▶ **Error! Bookmark not defined.**]

6.5.4.33 COLL.00 - T2SDCA: Follow-up by time slot of Settled Collateralisation Instructions - List Screen

△ [▶ **Error! Bookmark not defined.**]

No references for error messages.

6.5.4.34 COLL.00 - T2SDCA: Follow-up by time slot of Settled Collateralisation Instructions - Search Screen

△ [▶ **Error! Bookmark not defined.**]

6.5.4.35 COLL.01 - Securities Accounts: Follow up by time slot of Settled Collateralisation Instructions - Search Screen

△ [▶ **Error! Bookmark not defined.**]

6.5.4.36 COLL.01 - Securities Accounts: Follow-up by time slot of Settled Collateralisation Instructions - List Screen

△ [▶ **Error! Bookmark not defined.**]

No references for error messages.

6.5.4.37 COLL.02 - T2SDCA: Settled or Cancelled (automatic or manual) Collateralisation Instructions - List Screen

△ [▶ **Error! Bookmark not defined.**]

No references for error messages.

6.5.4.38 COLL.02 - T2SDCA: Settled or Cancelled (automatic or manual) Collateralisation Instructions - Search Screen

△ [▶ **Error! Bookmark not defined.**]

6.5.4.39 CPST.00 - T2SDCA: Follow-up by time slot of Cash Postings - List Screen

△ [▶ **Error! Bookmark not defined.**]

No references for error messages.

6.5.4.40 CPST.00 - T2SDCA: Follow-up by time slot of Cash Postings - Search Screen

△ [▶ **Error! Bookmark not defined.**]

6.5.4.41 LIQU.00 - Liquidity Transfers - List Screen

△ [▶ **Error! Bookmark not defined.**]

No references for error messages.

6.5.4.42 LIQU.00 - Liquidity Transfers - Search Screen

△ [▶ **Error! Bookmark not defined.**]

6.5.4.43 REAL.00 - Detailed Realignment and Other Technical Instructions - List Screen

△ [▶ **Error! Bookmark not defined.**]

No references for error messages.

6.5.4.44 REAL.00 - Detailed Realignment and Other Technical Instructions - Search Screen

△ [▶ **Error! Bookmark not defined.**]

6.5.4.45 REST.00 - Detailed Cash Restrictions - List Screen

△ [▶ **Error! Bookmark not defined.**]

No references for error messages.

6.5.4.46 REST.00 - Detailed Cash Restrictions - Search Screen

△ [▶ **Error! Bookmark not defined.**]

6.5.4.47 REST.01 - Detailed Securities Restrictions - Search Screen

△ [▶ **Error! Bookmark not defined.**]

6.5.4.48 REST.01 - Detailed Securities Restrictions - List Screen

△ [▶ **Error! Bookmark not defined.**]

No references for error messages.

6.5.4.49 SPST.00 - Securities Account: Follow-up by time schedule of Securities Postings – List Screen

△ [▶ **Error! Bookmark not defined.**]

No references for error messages.

6.5.4.50 SPST.00 - Securities Account: Follow-up by time schedule of Securities Postings - Search Screen

△ [▶ **Error! Bookmark not defined.**]

6.5.4.51 XREP.00 - T2SDCA: Matched Cancelled Instructions - List Screen

△ [▶ **Error! Bookmark not defined.**]

No references for error messages.

6.5.4.52 XREP.00 - T2SDCA: Matched Cancelled Instructions - Search Screen

△ [▶ **Error! Bookmark not defined.**]

6.5.4.53 XREP.01 - Securities Account: Matched Cancelled Instructions - List Screen

△ [▶ **Error! Bookmark not defined.**]

No references for error messages.

6.5.4.54 XREP.01 - Securities Account: Matched Cancelled Instructions - Search Screen

△ [▶ **Error! Bookmark not defined.**]

No references for error messages.

6.5.4.55 XREP.02 - Finalised Non Matched Cancellations - List Screen

△ [▶ **Error! Bookmark not defined.**]

No references for error messages.

6.5.4.56 XREP.02 - Finalised Non Matched Cancellations - Search Screen

△ [▶ **Error! Bookmark not defined.**]