

Single Shared Platform

**User Detailed Functional Specifications
- XML messages -**

4th book

Version 12.01

26 October 2018



Content

1 Introduction

1.1 General Information

1.2 XML standards

1.2.1 Compliance with SWIFT standard

1.3 Availability of XML schema files

1.4 ICM timezones

1.4.1 Messages sent from SSP

1.4.2 Messages sent to SSP

1.4.3 Time Zone Indication

1.5 Character Set

2 Usage of SWIFTNet Services

2.1 Pull Mode (Real-Time Protocol)

2.1.1 Synchronous SWIFTNet InterAct requests

2.1.2 Timeout management

2.1.3 Oversized data management

2.1.4 Timeout management in combination with oversized data

2.1.5 System errors

2.1.6 Technical compression

2.1.6.1 Technical note

2.1.6.2 Parameters

2.1.6.3 Implementation remark

2.1.6.4 Detailed description of technical data compression

2.1.6.4.1 Scope

2.1.6.4.2 Usage

2.1.6.4.3 Technical example

2.1.6.4.4 XML example (SWIFTNet InterAct)

2.1.6.4.5 Namespaces

2.2 File upload (Store-and-Forward)

2.2.1 Store-and-forward SWIFTNet FileAct requests

2.3 Push mode (Store-and-Forward)

2.3.1 Store-and-forward SWIFTNet InterAct and SWIFTNet FileAct requests

2.3.1.1 Polling initiated by the customer client application

2.3.1.2 Push initiated by the SWIFTNet store-and-forward server

2.3.2 Technical compression

2.4 Provisioning of files

2.4.1 CB traffic: statistical data & general ledger

2.4.2 Directory distribution/downloads

2.4.3 End of period Interest

2.4.4 CRSS

2.4.4.1 Invoicing Billing

2.4.4.2 ECB info: intraday credit

2.4.4.3 Eurosystem

2.4.4.4 Legal Archiving retrieval

2.4.5 Oversized data management process

2.4.5.1 Real-Time mode

2.4.5.2 Store-and-Forward mode for ASI

2.5 Internal routing

2.6 Task Queue protocol

2.6.1 General issue

2.6.2 Task Queue

2.6.3 Task processing

- 2.6.4 User action**
 - 2.6.4.1 Creation**
 - 2.6.4.2 Query**
 - 2.6.4.3 Modification**
 - 2.6.4.4 Summary**
- 2.6.5 Sample “Task Queue”**
- 2.7 Treatment of modified data (Delta Set)**
 - 2.7.1 General issues**
 - 2.7.2 Initialisation of the Delta Set**
 - 2.7.3 Query Type “CHNG”**
 - 2.7.4 Query Type “MODF”**
 - 2.7.5 Query Type “DELD”**
- 2.8 Security**
 - 2.8.1 Role Based Access Control**
 - 2.8.1.1 General issues**
 - 2.8.1.2 User roles for A2A**
 - 2.8.1.3 Error codes**
 - 2.8.2 Non-Repudiation of Emission**
- 3 Error codes**
 - 3.1 TARGET2 communication error codes**
 - 3.2 Common error codes**
 - 3.3 Individual error codes**
- 4 Description of XML messages**
 - 4.1 Introduction**
 - 4.1.1 Global structure of XML messages**

- 4.1.2 Example
- 4.1.3 Correlation / referencing of XML messages
- 4.2 Authorisation Context, Authenticator, and Requestor
- 4.3 Request control
- 4.4 Request Header
 - 4.4.1 Requestor DN
 - 4.4.2 Responder DN
 - 4.4.3 Service Name
 - 4.4.4 Request Type
- 4.5 Payload
- 4.6 Cryptographic Blocks
- 4.7 Message Signature
- 5 “Work as” and “act on behalf” scenario
 - 5.1 Definition
 - 5.2 Important information: One DN linked to several BIC11s (A2A)
 - 5.3 Example
 - 5.4 Implementation in A2A
 - 5.5 Examples
- 6 Description of the Payload
 - 6.1 How to read chapter 6
 - 6.2 Application Header
 - 6.2.1 Application Header ASI
 - 6.2.2 Application Header CM (*for CBs only*)
 - 6.2.3 Application Header HAM
 - 6.2.4 Application Header PM
 - 6.2.5 Application Header RMM

- 6.2.6 Application Header SDM**
- 6.2.7 Application Header SFM**
- 6.2.8 Application Header PHA Extern**
- 6.2.9 Application Header PHA Intern** *(for CBs only)*
- 6.2.10 Application Header T2SI**
- 6.2.11 ApplicationHeader CRSS**
- 6.3 Common XML messages**
 - 6.3.1 GetBroadcast**
 - 6.3.2 GetPendingData**
 - 6.3.3 GetSystemTime**
 - 6.3.4 GetTask**
 - 6.3.5 Receipt**
 - 6.3.6 ReturnBroadcast**
 - 6.3.7 ReturnSystemTime**
 - 6.3.8 ReturnTask**
- 6.4 XML messages related to PM**
 - 6.4.1 BackupPayment**
 - 6.4.2 BackupPayment** *(for CBs only)*
 - 6.4.3 CancelTransaction**
 - 6.4.4 DeleteLimit**
 - 6.4.5 DeleteReservation**
 - 6.4.6 GetAccount**
 - 6.4.7 GetBusinessDayInformation**
 - 6.4.8 GetCreditLine**
 - 6.4.9 GetLimit**
 - 6.4.10 GetReservation**

- 6.4.11 GetSequence**
- 6.4.12 GetSettlementInformation** *(for CBs only)*
- 6.4.13 GetTransaction**
- 6.4.14 LiquidityCreditTransfer**
- 6.4.15 ModifyCreditLine** *(for CBs only)*
- 6.4.16 ModifyLimit**
- 6.4.17 ModifyReservation**
- 6.4.18 ModifySequence**
- 6.4.19 ModifyTransaction**
- 6.4.20 ReleasePayment** *(for CBs only)*
- 6.4.21 ReturnAccount**
- 6.4.22 ReturnBusinessDayInformation**
- 6.4.23 ReturnCreditLine**
- 6.4.24 ReturnLimit**
- 6.4.25 ReturnReservation**
- 6.4.26 ReturnSequence**
- 6.4.27 ReturnSettlementInformation** *(for CBs only)*
- 6.4.28 ReturnTransaction**
- 6.4.29 RevokeTask** *(for CBs only)*

6.5 XML messages related to SD

- 6.5.1 DeleteHAMAccount** *(for CBs only)*
- 6.5.2 DeleteRTGSAccount** *(for CBs only)*
- 6.5.3 DeleteSFAccount** *(for CBs only)*
- 6.5.4 DeleteSubAccount** *(for CBs only)*
- 6.5.5 GetAS**
- 6.5.6 GetASSettBank**

- 6.5.7 GetCalendar**
- 6.5.8 GetCB**
- 6.5.9 GetContactItem**
- 6.5.10 GetDirectDebit**
- 6.5.11 GetErrorCode**
- 6.5.12 GetEvent**
- 6.5.13 GetGOA**
- 6.5.14 GetHAMAccount**
- 6.5.15 GetLegalEntity**
- 6.5.16 GetParticipant**
- 6.5.17 GetRTGSAccount**
- 6.5.18 GetSFAccount**
- 6.5.19 GetStandingOrderMirror**
- 6.5.20 GetStandingOrderSub**
- 6.5.21 GetStandingOrderDCA**
- 6.5.22 GetSubAccount**
- 6.5.23 GetT2Wildcard**
- 6.5.24 ModifyHAMAccount** *(for CBs only)*
- 6.5.25 ModifyLimit**
- 6.5.26 ModifyReservation**
- 6.5.27 ModifyRTGSAccount** *(for CBs only)*
- 6.5.28 ModifySFAccount** *(for CBs only)*
- 6.5.29 ModifyStandingOrder**
- 6.5.30 ModifyStandingOrderMirror**
- 6.5.31 ModifySubAccount** *(for CBs only)*
- 6.5.32 ReturnAS**

- 6.5.33 ReturnASSettBank**
- 6.5.34 ReturnCalendar**
- 6.5.35 ReturnCB**
- 6.5.36 ReturnContactItem**
- 6.5.37 ReturnDirectDebit**
- 6.5.38 ReturnErrorCode**
- 6.5.39 ReturnEvent**
- 6.5.40 ReturnGOA**
- 6.5.41 ReturnHAMAccount**
- 6.5.42 ReturnLegalEntity**
- 6.5.43 ReturnParticipant**
- 6.5.44 ReturnRTGSAccount**
- 6.5.45 ReturnSFAccount**
- 6.5.46 ReturnStandingOrderMirror**
- 6.5.47 ReturnStandingOrderSub**
- 6.5.48 ReturnStandingOrderDCA**
- 6.5.49 ReturnSubAccount**
- 6.5.50 ReturnT2Wildcard**
- 6.6 XML messages related to ASI**
 - 6.6.1 ASInitiationStatus**
 - 6.6.2 ASTransferInitiation**
 - 6.6.3 ASTransferNotice**
 - 6.6.4 Receipt_ASI**
 - 6.6.5 Receipt_AS**
 - 6.6.6 ReturnAccount**
 - 6.6.7 ReturnGeneralBusinessInformation_AS**

6.6.8 ReturnGeneralBusinessInformation_ASI

6.6.9 SBTransferInitiation

6.7 XML message related to HAM

6.7.1 CancelTransaction *(for CBs only)*

6.7.2 GetAccount

6.7.3 GetBusinessDayInformation

6.7.4 GetReservation

6.7.5 GetThreshold *(for CBs only)*

6.7.6 GetTransaction

6.7.7 LiquidityCreditTransfer

6.7.8 ModifyReservation

6.7.9 ModifyStandingOrder

6.7.10 ModifyTransaction *(for CBs only)*

6.7.11 ReleasePayment *(for CBs only)*

6.7.12 ReportOnInterests *(for CBs only)*

6.7.13 ReturnAccount

6.7.14 ReturnBusinessDayInformation

6.7.15 ReturnReservation

6.7.16 ReturnThreshold *(for CBs only)*

6.7.17 ReturnTransaction

6.8 XML messages related to SF

6.8.1 GetAccount

6.8.2 GetTransaction

6.8.3 LiquidityCreditTransfer

6.8.4 ReturnAccount

- 6.8.5 **ReturnAccount (Push)** *(for CBs only)*
- 6.8.6 **ReturnTransaction**
- 6.9 **XML messages related to RM**
 - 6.9.1 **AuthorizePenalty** *(for CBs only)*
 - 6.9.2 **GetAccount**
 - 6.9.3 **GetCompulsoryReserve** *(for CBs only)*
 - 6.9.4 **GetPenalty** *(for CBs only)*
 - 6.9.5 **InsertCompulsoryReserve** *(for CBs only)*
 - 6.9.6 **InsertPHABalance** *(for CBs only)*
 - 6.9.7 **ReturnAccount**
 - 6.9.8 **ReturnCompulsoryReserve** *(for CBs only)*
 - 6.9.9 **ReturnPenalty** *(for CBs only)*
 - 6.9.10 **SendPeriodicFlow** *(for CBs only)*
- 6.10 **XML messages related to CM** *(for CBs only)*
 - 6.10.1 **GetAccount** *(for CBs only)*
 - 6.10.2 **GetBusinessDayInformation** *(for CBs only)*
 - 6.10.3 **GetTransaction** *(for CBs only)*
 - 6.10.4 **LiquidityCreditTransfer** *(for CBs only)*
 - 6.10.5 **ReturnAccount** *(for CBs only)*
 - 6.10.6 **ReturnBusinessDayInformation** *(for CBs only)*
 - 6.10.7 **ReturnTransaction** *(for CBs only)*
- 6.11 **XML messages related to PHA**
 - 6.11.1 **ConfirmTask** *(for CBs only)*
 - 6.11.2 **GetAccount**
 - 6.11.3 **GetCreditLine**
 - 6.11.4 **LiquidityCreditTransfer**

- 6.11.5 ModifyStandingOrder**
- 6.11.6 ReturnAccount**
- 6.11.7 ReturnCreditLine**
- 6.11.8 RevokeTask** *(for CBs only)*
- 6.12 XML messages related to T2SI**
 - 6.12.1 BankToCustomerDebitCreditNotification**
 - 6.12.2 CancelTransaction**
 - 6.12.3 GetAccount**
 - 6.12.4 GetTransaction**
 - 6.12.5 LiquidityCreditTransfer**
 - 6.12.6 LiquidityDebitTransfer** *(for CBs only)*
 - 6.12.7 Receipt**
 - 6.12.8 ReturnAccount**
 - 6.12.9 ReturnTransaction**
- 6.13 XML messages related to CRSS**
 - 6.13.1 BillingReport**
- 6.14 XML messages related to TIPS1**
 - 6.14.1 BankToCustomerDebitCreditNotification**
 - 6.14.2 GetAccount**
 - 6.14.3 LiquidityCreditTransfer**
 - 6.14.4 Receipt**
 - 6.14.5 ReturnAccount**

7 Annexes

1 Introduction

1.1 General information

This document aims at presenting a detailed description of the XML messages used by TARGET2 for different purposes:

- Application-to-application mode (A2A) of the Information and Control Module (ICM)
- Ancillary System Interface (for Ancillary Systems only)
- TARGET2-Securities Interface (T2SI)
- Distribution of the TARGET2 directory
- Special purposes of CBs (e.g. download “raw data file”)

The main addressees for the information provided are developers who intend to design an application supporting the XML interface of TARGET2.

In chapter 2 a general description is given on the “Usage of SWIFTNet Services” in TARGET2. Chapter 3 contains a list of the error codes used in A2A. Chapter 4 provides an overview of the XML messages and in chapter 5 the “work as” and “act on behalf scenario” is explained. The payload of XML messages supported by the different modules is described in chapter 6. In addition to the description examples are provided for XML messages. Chapter 7 provides additional information on “XML messages and user roles” as well as on “Connection to ICM – requirements for proprietary home accounting applications (PHA)”.

Beside this document developers and architects should also use SWIFTNet reference documentation published by SWIFT, eg

- SWIFTNet Service Description
- SWIFTNet Design Guide
- SWIFTNet Link Interface
- SWIFT Standards Handbook

Additional documentation related to connectivity and network topics is provided on the SWIFTNet Link Software Developer’s Toolkit CR-ROM which is available from SWIFT.

1.2 XML standards

As far as possible, SWIFT Standards compliant messages from business areas Cash Management and Payment Initiation are used by TARGET2. This is true for business and technical XML messages.

Most messages of the Cash Management business area are candidate for ISO registration. The ISO standard in place is ISO 20022. Standard schemas for already ISO registered messages may only be provided by ISO and no longer by SWIFT. The camt.077 BillingReport as an exception has not yet been passed to a SWIFT Standards release but is also a candidate for ISO registration.

1.2.1 Compliance with SWIFT standard

SWIFT standardised XML messages cover all likely business cases within a payment system in order to ease the data exchange between different payment systems. The SSP subscribes as far as possible to the SWIFT standard messages.

Since the SSP covers just a part of the comprehensive business cases defined in the SWIFT standards, only a subset of the SWIFT XML standard is implemented by SSP.

SSP provides XML schema files that are SWIFT standard compliant. In these schema files the unused elements are removed.

Typically TARGET2 supports two versions of schema-files within A2A mode (downward compatibility):

Due to customer related requirement and for smooth transition reasons, CAMT **version 2012** (former CAMT version 5.0) and **CAMT version 2017** are supported in parallel. **CAMT version 4.0 is not supported any more**. But T2SI does only support the **single** version used by T2S (with go-live of T2S release 3.0 in June 2019 the actual supported CAMT **version 2012 will be switched to CAMT version 2017**).

The communication with all modules except ASI is done using real-time mode. T2SI supports the real-time mode only for queries and related responses. TARGET2 uses the same CAMT version to respond as the request sent by the participant. This also includes FileAct downloads due to the Oversized Data Management process.

But the version used TARGET2 to forward a request to a PHA is always the old CAMT version.

Store-and-Forward mode is used by ancillary systems or other participants accessing the ASI module and is also used by participants and third parties for sending settlement-related messages (ie liquidity transfers and orders) to T2SI. Messages sent by the ASI module are send in the old CAMT version. Nevertheless participants can send their messages using the new version as specified in the UDFS. The same applies to all ASI related FileAct transfers.

The TARGET2 Directory (regardless of push or pull mode) is also not affected by this change.

The documentation within Book 4 is based on **CAMT version 2017**. The documentation of version **2012** can be found in the prior version 11.01 of Book 4.

The version number of the single CAMT message is not in every case concurrent with the CAMT Release number. The published lower version number belongs to CAMT **version 2012** and higher version number belongs to **CAMT version 2017**.

Example:

ssp.pm.GetReservation.camt.046.001.03.xsd → belongs to CAMT version **2012**,

ssp.pm.GetReservation.camt.046.001.04.xsd → belongs to CAMT version **2017**.

The following messages of the Cash Management Standards 4.0 and proprietary messages is **no longer** valid since the implementation of the SSP Release V12.0 (November 2018):

ASI

- ssp.asi.ReturnAccount\$camt.004.001.04
- ssp.asi.ReturnGeneralBusinessInformation\$camt.021.001.02

Common

- ssp.GetBroadcast\$camt.998.001.01
- ssp.GetPendingData\$camt.998.001.01
- ssp.GetSystemTime\$camt.998.001.01
- ssp.GetTask\$camt.998.001.01
- ssp.Receipt\$camt.025.001.02
- ssp.ReturnBroadcast\$camt.998.001.01
- ssp.ReturnSystemTime\$camt.998.001.01
- ssp.ReturnTask\$camt.998.001.01

HAM

- ssp.ham.CancelTransaction\$camt.008.001.04

- ssp.ham.GetAccount\$camt.003.001.04
- ssp.ham.GetBusinessDayInformation\$camt.018.001.02
- ssp.ham.GetReservation\$camt.046.001.02
- ssp.ham.GetThreshold\$camt.998.001.01
- ssp.ham.GetTransaction\$camt.005.001.04
- ssp.ham.LiquidityCreditTransfer\$camt.050.001.02
- ssp.ham.ModifyReservation\$camt.048.001.02
- ssp.ham.ModifyStandingOrder\$camt.024.001.03
- ssp.ham.ModifyTransaction\$camt.007.001.04
- ssp.ham.ReportOnInterests\$camt.998.001.01
- ssp.ham.ReturnAccount\$camt.004.001.04
- ssp.ham.ReturnBusinessDayInformation\$camt.019.001.03
- ssp.ham.ReturnReservation\$camt.047.001.02
- ssp.ham.ReturnThreshold\$camt.998.001.01
- ssp.ham.ReturnTransaction\$camt.006.001.04

PHA

- ssp.pha.ConfirmTask\$camt.998.001.01
- ssp.pha.GetAccount\$camt.003.001.04
- ssp.pha.GetCreditLine\$camt.998.001.01
- ssp.pha.LiquidityCreditTransfer\$camt.050.001.02
- ssp.pha.ModifyStandingOrder\$camt.024.001.03
- ssp.pha.ReturnAccount\$camt.004.002.04
- ssp.pha.ReturnCreditLine\$camt.998.001.01
- ssp.pha.RevokeTask\$camt.998.001.01

PM

- ssp.pm.BackupPayment\$camt.023.001.03
- ssp.pm.BackupPayment\$camt.998.001.01
- ssp.pm.CancelTransaction\$camt.008.001.04
- ssp.pm.DeleteLimit\$camt.012.001.04
- ssp.pm.DeleteReservation\$camt.049.001.02
- ssp.pm.GetAccount\$camt.003.001.04
- ssp.pm.GetBusinessDayInformation\$camt.018.001.02
- ssp.pm.GetCreditLine\$camt.998.001.01
- ssp.pm.GetLimit\$camt.009.001.04
- ssp.pm.GetReservation\$camt.046.001.02
- ssp.pm.GetSequence\$camt.998.001.01

- ssp.pm.GetSettlementInformation\$camt.998.001.01
- ssp.pm.GetTransaction\$camt.005.001.04
- ssp.pm.LiquidityCreditTransfer\$camt.050.001.02
- ssp.pm.ModifyCreditLine\$camt.998.001.01
- ssp.pm.ModifyLimit\$camt.011.001.04
- ssp.pm.ModifyReservation\$camt.048.001.02
- ssp.pm.ModifySequence\$camt.998.001.01
- ssp.pm.ModifyTransaction\$camt.007.001.04
- ssp.pm.ReleasePayment\$camt.998.001.01
- ssp.pm.ReturnAccount\$camt.004.001.04
- ssp.pm.ReturnBusinessDayInformation\$camt.019.001.03
- ssp.pm.ReturnCreditLine\$camt.998.001.01
- ssp.pm.ReturnLimit\$camt.010.001.04
- ssp.pm.ReturnReservation\$camt.047.001.02
- ssp.pm.ReturnSequence\$camt.998.001.01
- ssp.pm.ReturnSettlementInformation\$camt.998.001.01
- ssp.pm.ReturnTransaction\$camt.006.001.04

RMM

- ssp.rmm.AuthorizePenalty\$camt.998.001.01
- ssp.rmm.GetAccount\$camt.003.001.04
- ssp.rmm.GetCompulsoryReserve\$camt.998.001.01
- ssp.rmm.GetPenalty\$camt.998.001.01
- ssp.rmm.InsertCompulsoryReserve\$camt.998.001.01
- ssp.rmm.InsertPHABalance\$camt.998.001.01
- ssp.rmm.ReturnAccount\$camt.004.001.04
- ssp.rmm.ReturnCompulsoryReserve\$camt.998.001.01
- ssp.rmm.ReturnPenalty\$camt.998.001.01
- ssp.rmm.SendPeriodicFlow\$camt.998.001.01

SDM

- ssp.sdm.DeleteHAMAccount\$camt.998.001.01
- ssp.sdm.DeleteRTGSAccount\$camt.998.001.01
- ssp.sdm.DeleteSFAccount\$camt.998.001.01
- ssp.sdm.DeleteSubAccount\$camt.998.001.01
- ssp.sdm.GetAS\$camt.998.001.01
- ssp.sdm.GetASSettBank\$camt.998.001.01
- ssp.sdm.GetCalendar\$camt.998.001.01

- ssp.sdm.GetCB\$camt.998.001.01
- ssp.sdm.GetContactItem\$camt.998.001.01
- ssp.sdm.GetDirectDebit\$camt.998.001.01
- ssp.sdm.GetErrorCode\$camt.998.001.01
- ssp.sdm.GetEvent\$camt.998.001.01
- ssp.sdm.GetGOA\$camt.998.001.01
- ssp.sdm.GetHamAccount\$camt.998.001.01
- ssp.sdm.GetLegalEntity\$camt.998.001.01
- ssp.sdm.GetParticipant\$camt.998.001.01
- ssp.sdm.GetRTGSAccount\$camt.998.001.01
- ssp.sdm.GetSFAccount\$camt.998.001.01
- ssp.sdm.GetStandingOrderDCA\$camt.069.001.01
- ssp.sdm.GetSubAccount\$camt.998.001.01
- ssp.sdm.GetT2Wildcard\$camt.998.001.01
- ssp.sdm.ModifyHAMAccount\$camt.998.001.01
- ssp.sdm.ModifyLimit\$camt.011.001.04
- ssp.sdm.ModifyReservation\$camt.048.001.02
- ssp.sdm.ModifyRTGSAccount\$camt.998.001.01
- ssp.sdm.ModifySFAccount\$camt.998.001.01
- ssp.sdm.ModifyStandingOrder\$camt.024.001.03
- ssp.sdm.ModifySubAccount\$camt.998.001.01
- ssp.sdm.ReturnAS\$camt.998.001.01
- ssp.sdm.ReturnASSettBank\$camt.998.001.01
- ssp.sdm.ReturnCalendar\$camt.998.001.01
- ssp.sdm.ReturnCB\$camt.998.001.01
- ssp.sdm.ReturnContactItem\$camt.998.001.01
- ssp.sdm.ReturnDirectDebit\$camt.998.001.01
- ssp.sdm.ReturnErrorCode\$camt.998.001.01
- ssp.sdm.ReturnEvent\$camt.998.001.01
- ssp.sdm.ReturnGOA\$camt.998.001.01
- ssp.sdm.ReturnHamAccount\$camt.998.001.01
- ssp.sdm.ReturnLegalEntity\$camt.998.001.01
- ssp.sdm.ReturnParticipant\$camt.998.001.01
- ssp.sdm.ReturnRTGSAccount\$camt.998.001.01
- ssp.sdm.ReturnSFAccount\$camt.998.001.01
- ssp.sdm.ReturnStandingOrderDCA\$camt.070.001.01
- ssp.sdm.ReturnSubAccount\$camt.998.001.01

- ssp.sdm.ReturnT2Wildcard\$camt.998.001.01

SFM

- ssp.ham.GetAccount\$camt.003.001.04
- ssp.ham.GetTransaction\$camt.005.001.04
- ssp.sfm.LiquidityCreditTransfer\$camt.050.001.02
- ssp.ham.ReturnAccount\$camt.004.001.04
- ssp.ham.ReturnTransaction\$camt.006.001.04

CM

- ssp.cm.GetAccount\$camt.003.001.04
- ssp.cm.GetBusinessDayInformation\$camt.018.001.02
- ssp.cm.GetTransaction\$camt.005.001.04
- ssp.cm.LiquidityCreditTransfer\$camt.050.001.02
- ssp.cm.ReturnAccount\$camt.004.001.04
- ssp.cm.ReturnBusinessDayInformation\$camt.019.001.03
- ssp.cm.ReturnTransaction\$camt.006.001.04

T2SI (with go-live of T2S release 3.0)

- ssp.t2si.user.GetAccount.camt.003.001.05
- ssp.t2si.user.ReturnAccount.camt.004.001.05
- ssp.t2si.user.GetTransaction.camt.005.001.05
- ssp.t2si.user.ReturnTransaction.camt.006.001.05
- ssp.t2si.user.CancelTransaction.camt.008.001.05
- ssp.t2si.user.Receipt.camt.025.001.03
- ssp.t2si.user.LiquidityCreditTransfer.camt.050.001.03
- ssp.t2si.user.LiquidityDebitTransfer.camt.051.001.03

Availability of XML schema files

To ease the work of developers and architects and to support them in validating the XML messages used by the application they designed,

- XML sub-schema files for messages derived from the original SWIFT-Standard-schemas for the Cash Management (camt) and Payment Initiation (pain)
- Schema files for the so called SSP proprietary messages

are published on the TARGET2 website:

<https://target2.ecb.int>

They cover all XML messages used by SSP.

The XML sub-schema files are based on the last two actual versions of the SWIFT-Standard-schemas and have been customised according the demands of the SSP (i.e. sub-schemas are more restricted but full in line with the regulations of the SWIFT-XML-standard available on www.swift.com).

1.3 ICM timezones

1.3.1 Messages sent from SSP

Usually, the current time zone of SSP is indicated in the XML messages sent from SSP together with the date, time or date Time format.

The time zone is not indicated with some XML elements particularly defined in the XSD schema file.

The offset for the transformation from the SSP time indication to the customer local time is the local time zone of the customer minus the time zone indication in the message sent from SSP.

1.3.2 Messages sent to SSP

The time zone indication is optional in the XML messages sent to SSP. If no time zone is indicated the time zone used by SSP is the current time zone UTC+1 or UTC+2.

If a time zone is indicated in the message sent to SSP, SSP will transform the time indication to the current time used by SSP. The offset is the current time zone used by SSP minus the time zone indication in the message sent to SSP.

1.3.3 Time Zone Indication

The following table shows the valid formats for certain data types used in the XML messages exchanged between a customer application and SSP:

Data type	Format	Examples
date	yyyy'-mm'-dd(zzzzzz)?	2007-11-19 2007-11-19+01:00
time	hh':mm':ss(zzzzzz)?	12:30:45.999 12:30:45.999+01:00
dateTime	yyyy'-mm'-dd'T'hh':mm':ss('s+)?(zzzzzz)?	2007-11-19T12:30:45.999 2007-11-19T12:30:45.999+01:00

Where zzzzzz is “+01:00”, when daylight saving is not observed, or “+02:00”, when daylight serving is observed (summer time).

Links:

- More details on XML datatypes can be found on www.w3.org/TR/xmlschema-2
- General information on timezones are available at en.wikipedia.org/wiki/Timezone

1.4 Character Set

The A2A mode supports the full S.W.I.F.T “x” character set and additionally the following characters: * @ ! . Exclusion if the single XML element is restricted to a character subset within the “xsd” schema file.

The user of the A2A approach is committed to support and to use the above mentioned characters. In case of using of not supported characters, SSP will generate a “General system error”.

Due to the fact that the cash management standard messages are based on the UNIFI (ISO 20022) XML messages (especially regarding free text fields) will allow for the full range of global language requirements (UTF-8), which is broader than the S.W.I.F.T. “x” character set, the user of the A2A approach is obliged to use only the mentioned enriched S.W.I.F.T “x” character set.

2 Usage of SWIFTNet Services

The following sections provide information on how to use the SWIFTNet InterAct and SWIFTNet FileAct services. The SWIFTNet services are applied in different communication protocols and relationships:

- InterAct – Real-Time Messaging Mode
 - Standard A2A message exchange (via ICM)
 - Queries to and responses from T2SI
- FileAct – Real-Time File Download Mode (pull)
 - Download oversized data
 - Download of the TARGET2 directory (full version)
 - Download of the TARGET2 directory (delta version)
 - Download of the “raw data file” (for Central Banks only)
- InterAct – Store-and-Forward Messaging Mode
 - Messages to ASI
 - Messages pushed by ASI
 - Settlement related messages to T2SI
 - Settlement related messages pushed by T2SI
- FileAct – Store-and-Forward File Transfer Mode
 - File upload to ASI
 - Files pushed by ASI
 - Provisioning (push) of the TARGET2 directory (delta-version)
 - Provisioning (push) of the “general ledger file”
 - Files pushed by CRSS

2.1 Pull Mode (Real-Time Protocol)

TARGET2 is a service provider who processes small requests sent by an application (customer client) and returns responses to it. The responses are either messages or files.

2.1.1 Synchronous SWIFTNet InterAct requests

The transfer of messages from TARGET2 to the customer is initiated on request of the customer’s application (pull mode).

The communication follows the client/server model. TARGET2 processes the requests sent by the customer client application. Requests will synchronously be answered with a response.

The following flow chart illustrates the normal course of operations:

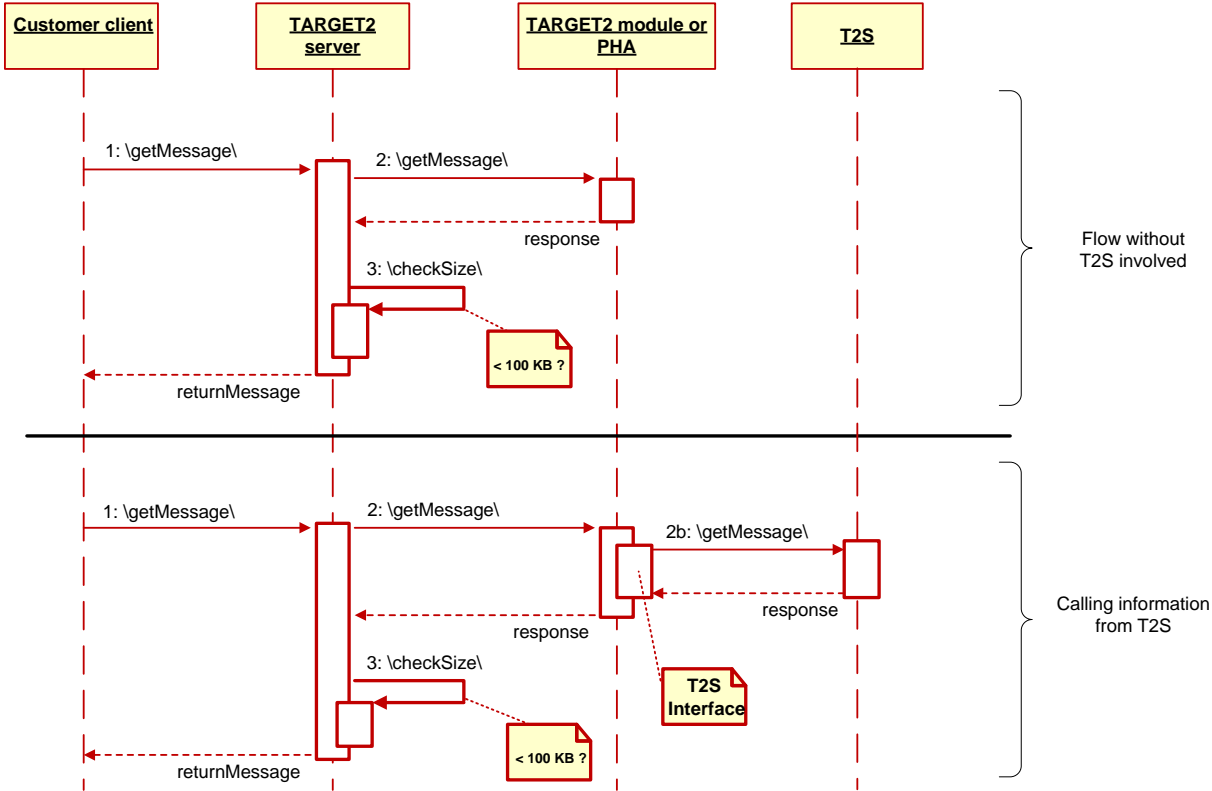

1. The customer client sends a SWIFTNet InterAct request to the TARGET2 server.
2. The request is forwarded to the addressed TARGET2 module or PHA.
 - 2b) If the request is a query to T2S, T2SI will forward the message to T2S.
3. If the size will be below the TARGET2 message size limit of 100 kB, the server will return a SWIFNet InterAct response. The response may contain one of the following messages:
 - The requested business data – as response to information requests
 - A technical confirmation message, that the request is forwarded to the TARGET2 module or PHA – as response to control requests
 - A technical error message – as response to all types of requests

Note: If the size exceeds the TARGET2 message size limit of 100 kB the “oversized data management” will apply (see UDFS book 4, chapter 2.1.3).

The technical error messages may require subsequent actions to clear the situation. These actions are in particular related to the following issues:

- Timeout management (see *UDFS book 4, chapter 2.1.2*)
- Oversized data (see *UDFS book 4, chapter 2.1.3*)
- Error codes (see *UDFS book 4, chapter 3*)

2.1.2 Timeout management

As defined by SWIFT, the execution time of a SWIFTNet InterAct request and SWIFTNet FileAct request is limited to 60 sec. If the execution is not finished within that period of time, the transmission will be automatically interrupted by the SWIFTNet and SWIFTNet will return an error message to the customer client.¹

Common rule: In case of an error TARGET2 will return the appropriate Return message. This behaviour is also conferrable for “oversized data management” and “timeout management”. If the request is a Get message the corresponding Return message will be performed (e.g. GetTransaction – ReturnTransaction).

If the request is e.g. ModifyReservation the corresponding Return message (Receipt) will be performed.

In case of a “timeout” this is indicated with status code "1001" in element "StsCd" or "Err" (depending on the message type). The reference to the subsequent query is indicated with elements “OrgnlBizQry”, "BizQryRef", "Rltd" or "RltdRef" (depending on the message type). TARGET2 will return the appropriate ReturnMessage as response.

To heal the SWIFTNet timeout limit, TARGET2 offers an effective protocol.

TARGET2 defines a timeout limit that anticipates the SWIFTNet timeout limit. If the processing of a certain request takes longer than the TARGET2 timeout limit, an automatic changeover to an asynchronous protocol will be required. The asynchronous protocol ensures, that all requested data can be retrieved properly.

The TARGET2 timeout limit is considerably lower than 60 seconds.

¹ Please note: New functionality of the modification of several limits (ModifyLimit request) and deletion of all current limits (via DeleteLimit) may cause a timeout situation of a huge number of bilateral limits is affected.

The following sequence diagram illustrates the timeout management protocol:

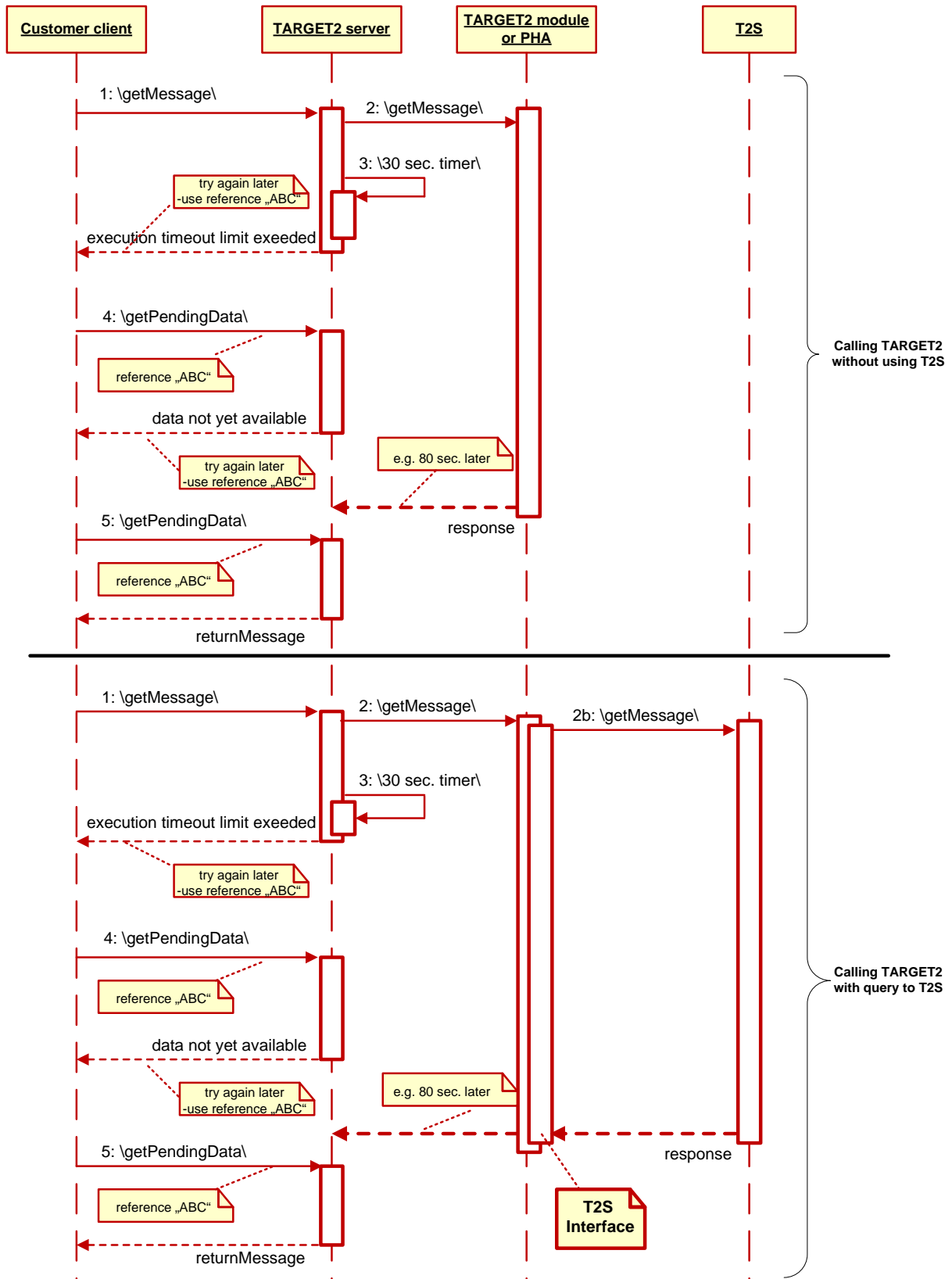

1. The customer client sends a SWIFTNet InterAct request to the TARGET2 server.

2. The request is forwarded to the addressed TARGET2 module or PHA. The processing time exceeds the TARGET2 timeout limit.

2b) If the request is a query to T2S, T2SI will forward the message to T2S.

3. If the server cannot respond to the request within the timeout limit (e.g. 30 seconds), a TARGET2 timeout message with status code “1001” will be sent as response. The timeout status message includes the related reference for the later access to the data.

4. After a delay, a subsequent SWIFTNet InterAct request may be sent by the customer client with the related reference to retrieve the pending data. If the data is still not available, a message with status code “1002” that states that the data is not yet available is returned to the customer client.

5. Repetition of 4: After a delay, a subsequent SWIFTNet InterAct request may be sent by the customer client with the same related reference as in 4 to retrieve the data. If the data are available, it will be returned as a SWIFTNet InterAct response to the customer client. The repetition is possible up to a second timeout. After the second timeout the data is no longer available. Then each request for the pending data will be returned with status code “1005”.

The delay between step 3 and step 4 is the choice of the customer client application.

Parameters

Parameter	Value
TARGET2 timeout limit	e.g. 30 sec. ²
max. TARGET2 timeout limit/ SWIFTNet timeout limit	60 sec. ³
Second timeout limit	600 sec. ⁴

² This parameter is variable and will be tuned to the maximum depending on operating experience

³ This parameter is fixed by the SWIFTNet technical specification

⁴ This parameter is variable and might be modified depending on operating experience

2.1.3 Oversized data management

As defined by SWIFT, SWIFTNet InterAct limits the payload to 100 kB⁵. Messages with a bigger volume are automatically blocked by the SWIFTNet.

The size restriction has consequences for a) customer requests and b) TARGET2 return messages.

Messages sent by customer applications that may breach the size limit (currently only in case of ModifyLimit [from version 4.0] possible for the reason of allowed unbounded repetition of LimitDetails) have to be checked for their size before transmission to SWIFTNet. If the size limit would be breached the request has to be divided into as many parts as necessary to obey the restriction. Compression of requests is not supported.

On TARGET2 side, to avoid the size restriction of SWIFTNet InterAct, SWIFTNet FileAct is applied for the download of oversized data.

TARGET2 checks the size of the response. If compression of responses is arranged with TARGET2 the decisive size is the size of the message after compression. If the size of the response exceeds the TARGET2 message limit⁶, an automatic changeover to SWIFTNet FileAct is offered. The use of SWIFTNet FileAct ensures, that all requested data can be retrieved properly.

Common rule: In case of an error TARGET2 will return the appropriate Return message. This behaviour is also conferrable for “oversized data management” and “timeout management”. If the request is a Get message the corresponding Return message will be performed (e.g. GetTransaction – ReturnTransaction).

If the request is e.g. ModifyReservation the corresponding Return message (Receipt) will be performed.

In case of a “oversized Message size limit exceeded” this is indicated with status code "1003" in element "StsCd" or "Err" (depending on the message type). The reference to the subsequent query is indicated with elements “OrgnlBizQry”, "BizQryRef", "Rltd" or "RltdRef" (depending on the message type). TARGET2 will return the appropriate ReturnMessage as response.

⁵ The exact value is 99.953 Byte minus the <ResponsePayload> tag.

⁶ The TARGET2 message size limit must not exceed the maximum message size for SWIFTNet InterAct. It is currently in line with the maximum size for messages exchanged using SWIFTNet InterAct.

SWIFTNet FileAct has a size limit as well. The absolute maximum amount of data that can be retrieved with one request from the TARGET2 server is the SWIFTNet FileAct limit.

The following sequence diagram illustrates the oversized data management protocol:

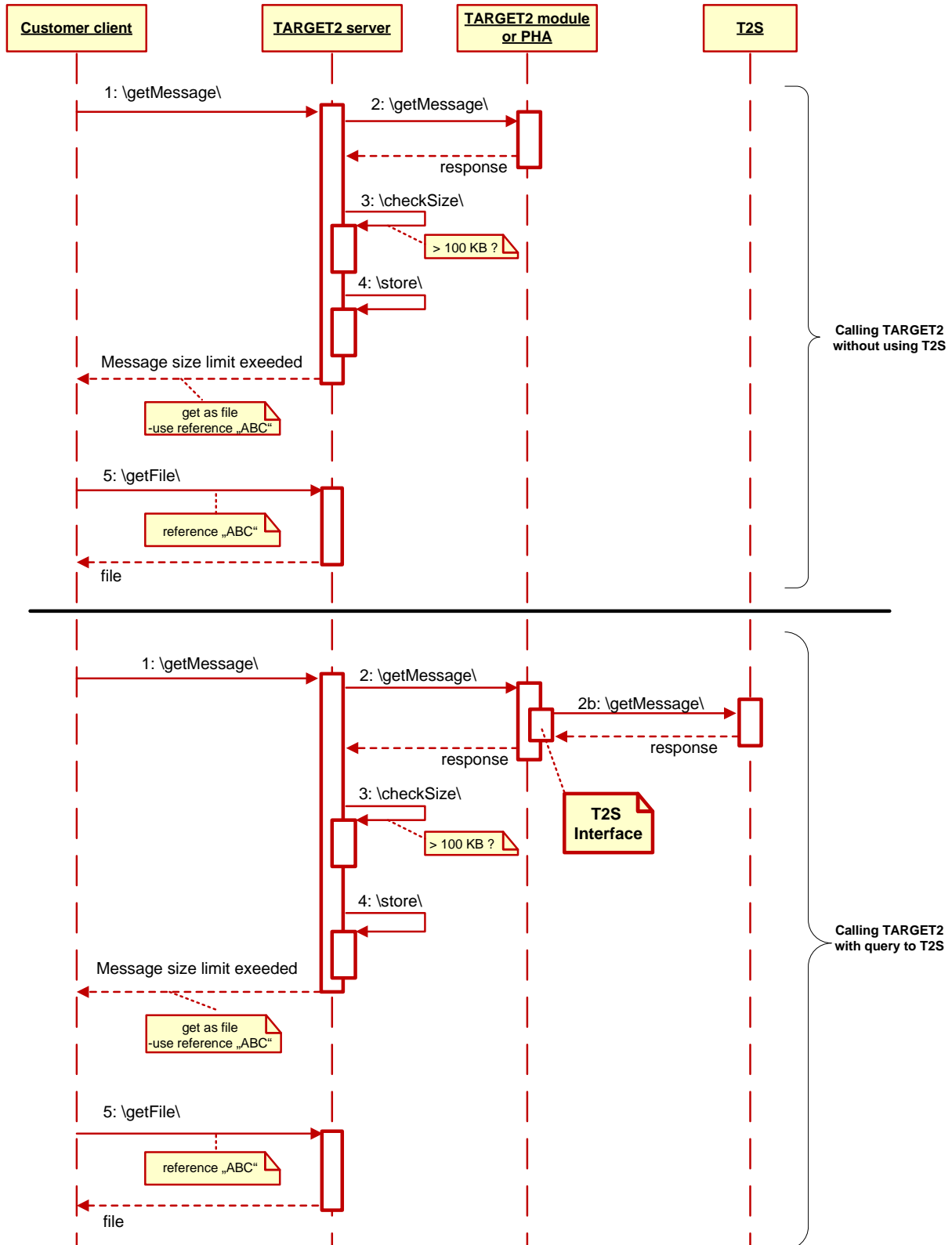

1. The customer client sends a SWIFTNet InterAct request to the TARGET2 server.
2. The request is forwarded to the addressed TARGET2 module or PHA.
 - 2b) If the request is a query to T2S, T2SI will forward the message to T2S.
3. The size of the response is checked.
4. If the size of the response is too large for transport with SWIFTNet InterAct, a file will be created and stored and a message with status code 1003 will be sent as response. The size status message includes the related reference for the later access to the file.
5. A subsequent SWIFTNet FileAct request is sent by the customer client with the related reference as file name (Sw:LogicalName) to retrieve the data. TARGET2 checks the authorisation: The SWIFTNet FileAct request must be sent with the same DN as the initial SWIFTNet InterAct request. Then the data will be returned as a file via SWIFTNet FileAct to the customer client.

Parameters

Parameter	Value
TARGET2 message size limit	100 kB ^{1,2}
SWIFTNet FileAct size limit	250 Mbyte ²

¹ The TARGET2 message size limit can be decreased by TARGET2 OT users.

² This maximum value is fixed by the SWIFTNet technical specification.

2.1.4 Timeout management in combination with oversized data

The following sequence diagram illustrates the combination of the timeout management and oversized data management protocol:

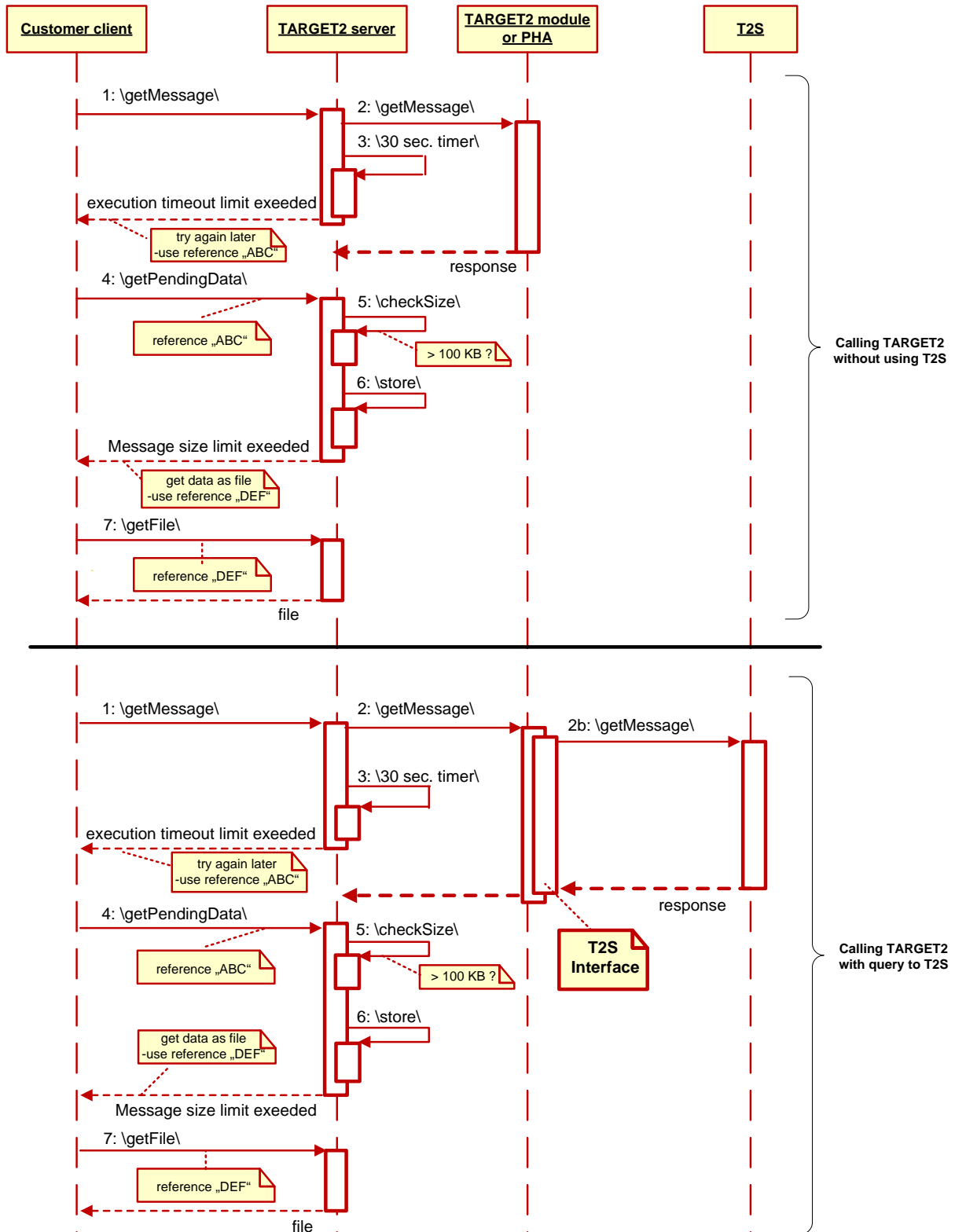

1. The customer client sends a SWIFTNet InterAct request to the TARGET2 server.
2. The request is forwarded to the addressed TARGET2 module or PHA.
 - 2b) If the request is a query to T2S, T2SI will forward the message to T2S.
3. If the server can not respond to the request within a fixed period of time a timeout status message will be returned as response. The timeout status message includes the related reference for the later access to the data.
4. A subsequent SWIFTNet InterAct request is sent by the customer client with the related reference to retrieve the data with SWIFTNet InterAct.
5. If the data is available and TARGET2 detects that the size of the data is too large for the transport with SWIFTNet InterAct, an size status message will be returned as response. The size status message includes the related reference for the later access to the data.
6. The data is put to a file and the file is stored at TARGET2 site for later retrieval.
7. A subsequent SWIFTNet FileAct request is sent by the customer client with the related reference to retrieve the file. TARGET2 checks the authorisation: The SWIFTNet FileAct request must be sent with the same DN as the initial SWIFTNet InterAct request. Then the data will be sent as a file via SWIFTNet FileAct to the customer client.

2.1.5 System errors

It is not always possible to process a message at TARGET2 site. Internal technical errors may result to a rejection of a message. If a request cannot be executed, an error message will be returned to the customer. Then the customer is advised to wait a short time and to send the same message again.

The following sequence diagram illustrates the course of operation:

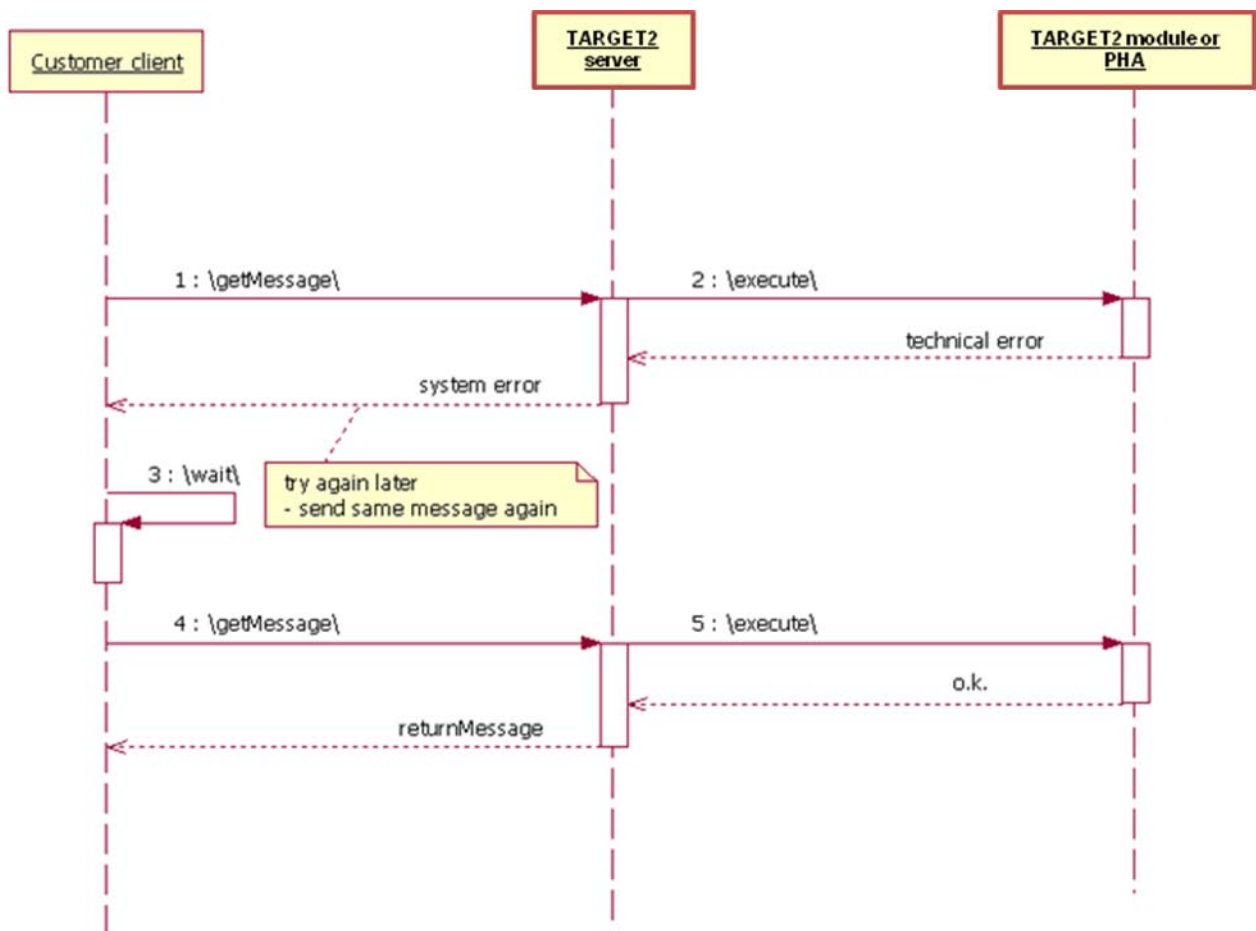

1. The customer client sends a SWIFTNet InterAct request.
2. The request is forwarded to the internal TARGET2 module or PHA. Due an internal technical error, the request cannot be executed.
3. The customer waits 1-2 minutes.
4. The customer client sends the same SWIFTNet InterAct request again.
5. The request is forwarded to the internal TARGET2 module or PHA. The request can be executed now.

2.1.6 Technical compression

If arranged between the user and TARGET2, large messages will be compressed in zip file format before transmission. The advantage is that transmission fees are reduced to a minimum. To read the data, it is necessary to decompress the compressed messages at the customer site.

Files are only compressed, if it is opted to receive between TARGET2 and the participant.

If the file is compressed, the archive of TARGET2 contains TARGET2 data (ApplicationHeader and document) only. SWIFT's SwInt:ExchangeResponse is not included in the archive of TARGET2. Files are not Base64 encoded. Only compressed InterAct messages are encoded. The decompression results to TARGET2 relevant data (ApplicationHeader and document) only without SwInt:ResponsePayload.

TARGET2 defines a compression size limit. A returned message that exceeds this limit will be compressed (see chapter 2.1.6.2 Parameters), precondition is that a compression between TARGET2 and A2A-Participant is arranged. Due to protocol overhead, the very small messages will not be compressed. If the compressed data exceeds the TARGET2 message size limit, it will be provided as file.

The following activity diagram illustrated the compression algorithm:



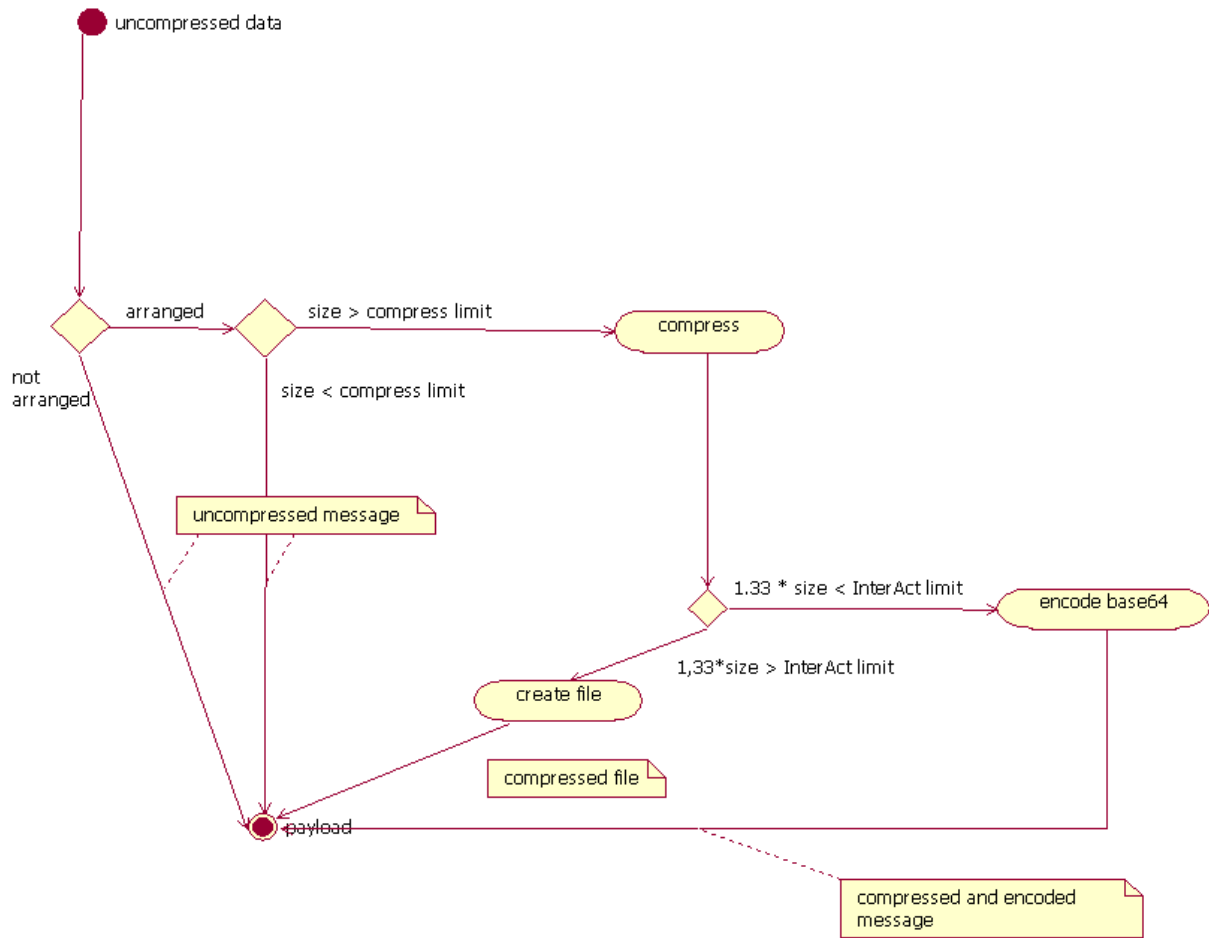

2.1.6.1 Technical note

Compressed data transmitted via SWIFTNet InterAct is Base64 encoded. This is necessary because of the valid character set of this SWIFTNet service. The Base64 encoding enlarges the compressed data by 33 %. The Base64 encoding will not be used for the transmission of compressed data via SWIFTNet FileAct.

2.1.6.2 Parameters

Parameter	Value	
Compression algorithm	ZIP	
Compression size threshold	2kB	
Requests	<i>no compression</i>	
Encoding	SWIFTNet InterAct	Base64
	SWIFTNet FileAct	<i>no encoding</i>

2.1.6.3 Implementation remark

The ZIP decompression is supported by libraries, which are available as shareware:

Link for download: <http://www.winimage.com/zLibDll/>

2.1.6.4 Detailed description of technical data compression

2.1.6.4.1 Scope

Technical compressed data can be send by the TARGET2 server to the customer client application as response to all SWIFTNet InterAct and SWIFTNet FileAct requests.

2.1.6.4.2 Usage

SWIFTNet InterAct: The compressed message is the payload of the response.

SWIFTNet FileAct: The file content is compressed.

The indication that a response contains a compressed message depends on the SWIFTNet service as follows:

- SWIFTNet InterAct:
 - Element: SwInt:ResponsePayload
 - Attribute: dt
 - Value: "ZIP-Base64"
- SWIFTNet FileAct:
 - Element: Sw:FileInfo
 - Value: "SwCompression=Zip" (recommended by SWIFT)

As the SwCompression keyword is mandatory, in case of a non compressed file:

- Element: Sw:FileInfo
- Value: "SwCompression=None"

2.1.6.4.3 Technical example

A user wants to query the payment queue at the TSSP server site with a *GetTransaction* message. The result of the inquiry is large enough, so that the compression of the message saves SWIFTNet transmission fees.

TARGET2 automatically compresses the message before the transmission.

The user decompresses the response to read the requested message.

2.1.6.4.5 Namespaces

The XML elements of all incoming and outgoing messages must be associated to an XML namespace⁷. The namespace declaration establishes a link to the XSD schema used for validation. Only elements that are associated to the correct XML namespace can be validated. Incoming messages that are not valid cannot be processed by TARGET2 and will be rejected.

The namespace of the XML messages must match to the “targetNamespace” defined in the related customised schema files provided by TARGET2. It is either a SWIFT standard namespace or ISO standard namespace.

The namespace must be declared in the start-tag of the first element that is associated to the namespace. These elements are the application header and the business document. The tags are <AppHdr> and <Document>. The namespace declaration is an attribute of these tags.

Examples CAMT version 5.0:

- `<AppHdr xmlns="urn:swift:xsd:$ahV10">`
- `<Document xmlns="urn:swift:xsd:camt.003.001.05">`

Namespace prefixes (e.g. “Doc:”) may be used in XML messages sent from the user to TARGET2. But users must be aware that this enlarges the message size what may result to higher transmission fees. TARGET2 will not use a namespace prefix in XML messages sent to the user.

2.2 File upload (Store-and-Forward)

TARGET2 is a service provider who accepts and processes files that are pushed by the customer client application.

⁷ An XML namespace is a collection of names, identified by a URI reference, which are used in XML documents as element types and attribute names. (by W3C, “Namespace in XML”, W3C, 14.01.1999)

2.2.1 Store-and-forward SWIFTNet FileAct requests

The transfer of files from the customer to TARGET2 is initiated on request of the customer client application (file put request).

The customer uploads the file to the store-and-forward server of the SWIFTNet. TARGET2 retrieves the file from there according to the SWIFTNet store-and-forward features. After the receipt the file processing is executed asynchronously: The status of the operation is reported with the task queue protocol (see chapter 2.6 for details).

The following sequence diagram illustrates the course of operations:

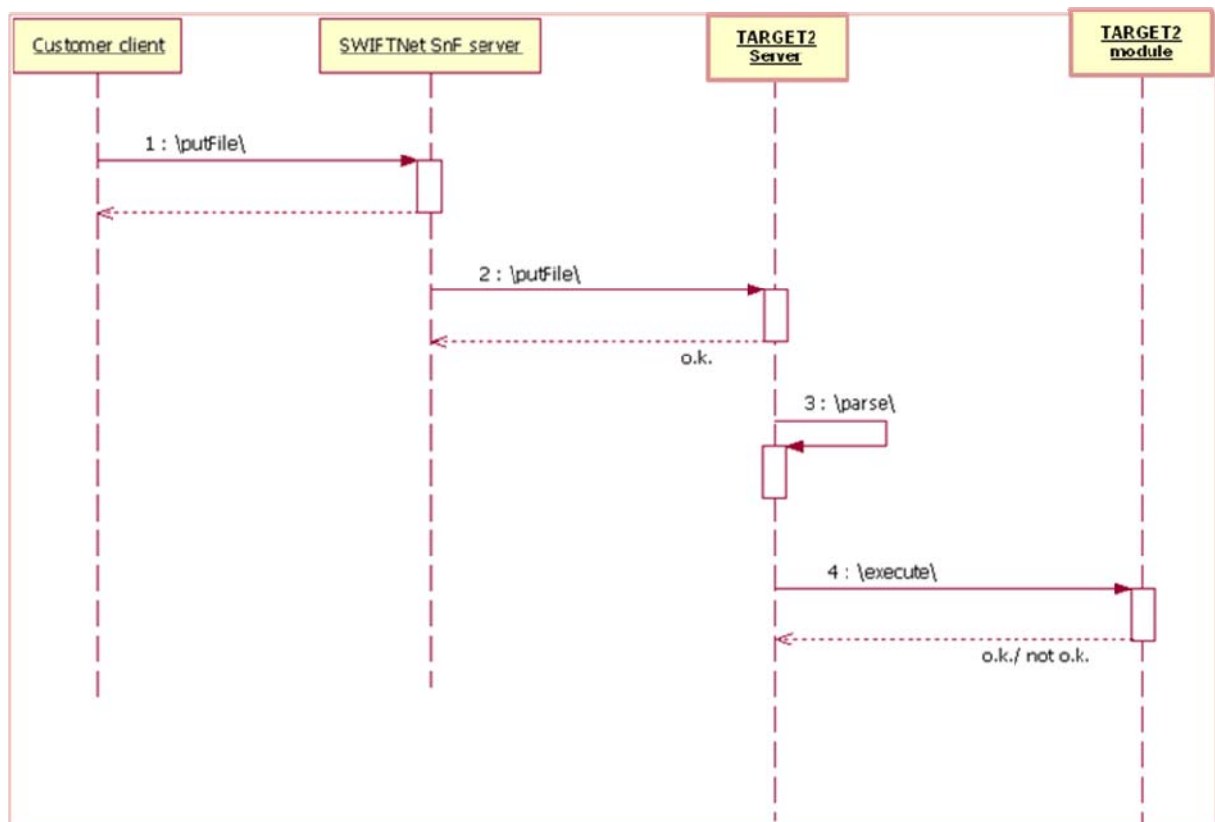

1. The customer client sends a put file request to the SWIFTNet store-and-forward server. The SWIFTNet store-and-forward server is available according to the SWIFT service level agreements.
2. If the TARGET2 server is ready to receive a file, the file will be transferred by the SWIFTNet store-and-forward server via SWIFTNet FileAct.
3. The content of the file is parsed by the TARGET2 server.
4. The parsed request is forwarded to the internal TARGET2 module and executed.

2.3 Push mode (Store-and-Forward)

The customer processes requests pushed by TARGET2. The request is either a SWIFTNet InterAct message or a SWIFTNet FileAct file.

Depending on the store-and-forward mode, the customer could be a service provider or a client application.

2.3.1 Store-and-forward SWIFTNet InterAct and SWIFTNet FileAct requests

The transfer of message or files from TARGET2 to the customer is initiated on request of TARGET2 (put request).

TARGET2 uploads the message or file to the store-and-forward server of the SWIFTNet as soon as the data is available. A customer application can retrieve the message or file from there according to the SWIFTNet store-and-forward features with one of the following techniques:

- Polling initiated by the customer client application
- Push initiated by the SWIFTNet store-and-forward server

2.3.1.1 Polling initiated by the customer client application

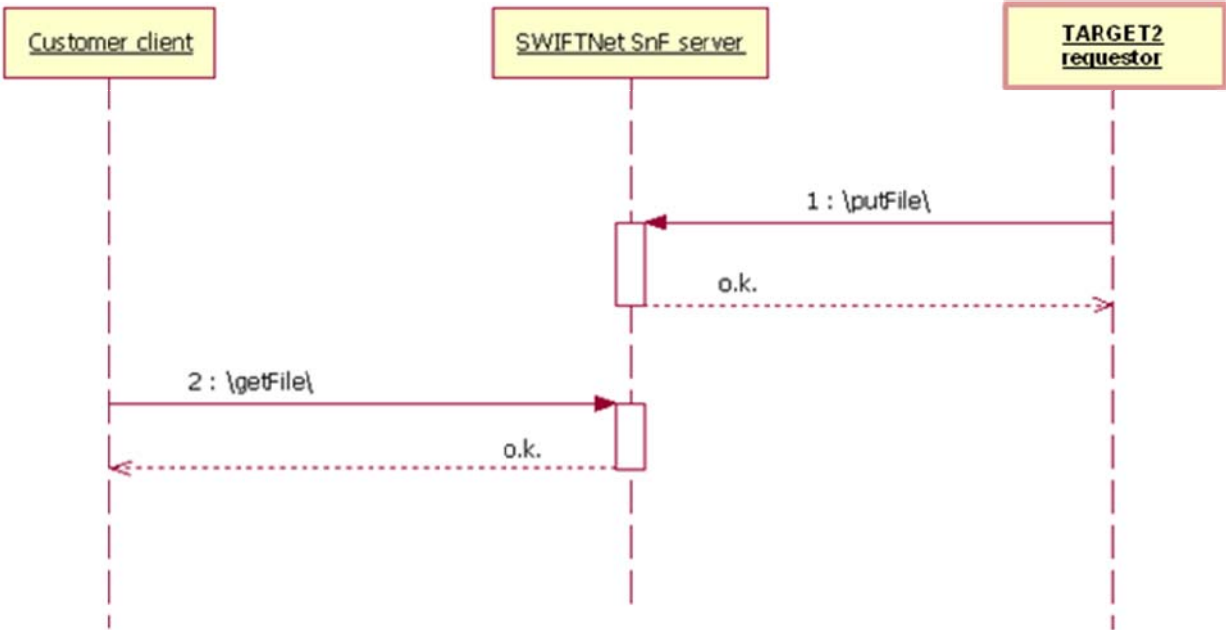

1. TARGET2 pushes the message or file to the SWIFTNet store-and-forward server.
2. The customer client polls the SWIFTNet store-and-forward server to get the message or file. If no message or file is available, the poll operation will be repeated regularly.

2.3.1.2 Push initiated by the SWIFTNet store-and-forward server

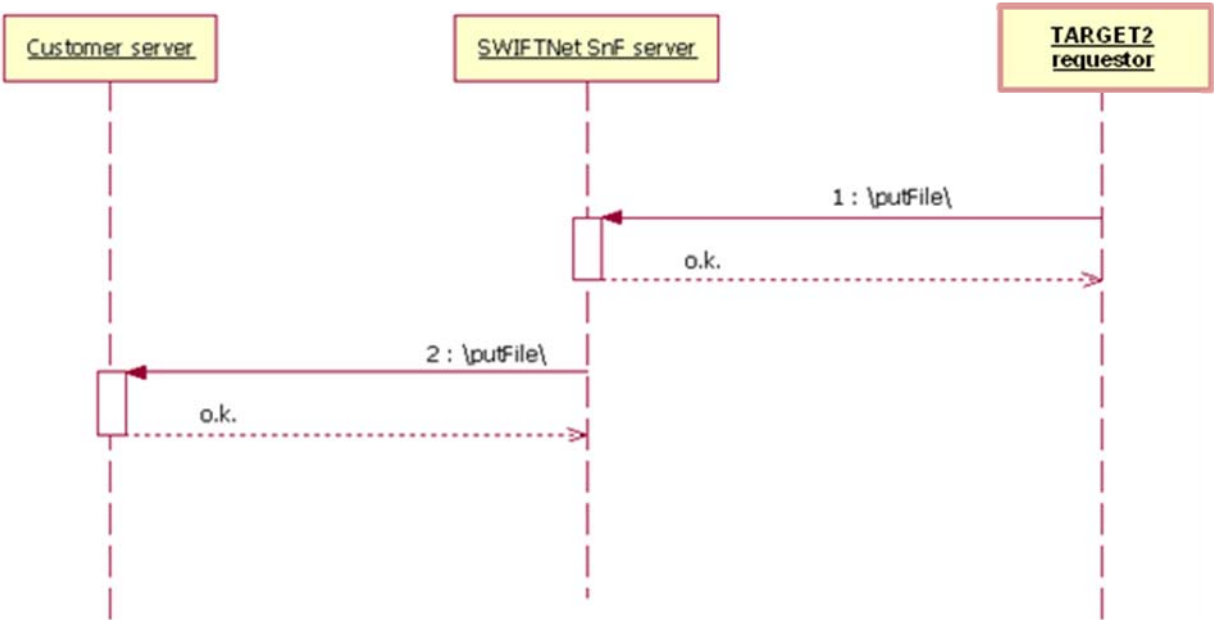

1. TARGET2 pushes the message or file to the SWIFTNet store-and-forward server.
2. The SWIFTNet store-and-forward server forwards the message or file to the customer server application. If the customer server application is not available, the SWIFTNet will store the file according to the SWIFTNet store-and-forward service level

agreements. The forwarding of messages already stored by the SWIFTNet store-and-forward server and not delivered to the customer server application because of its unavailability has anyway to be triggered by the customers. They have to acquire the queues pertaining to the push-mode end-point.

2.3.2 Technical compression

To save transmission fees, large messages and files will be compressed before transmission.

TARGET2 defines a compression size threshold. Every message and file that exceeds this threshold will be compressed. Due to protocol overhead, the very small messages and files will not be compressed.

For technical details please see chapter 2.1.6.

2.4 Provisioning of files

The TARGET2 provides the following files to the users:

- TARGET2 directory
 - o full version (Real Time pull mode only⁸)
 - o delta version (Real Time pull mode or Store and Forward push mode⁹)
- General ledger file (for CBs only - Store and Forward push mode)
- Raw data file (for CBs only - Real Time pull mode)
- Information related to the “End of Period Interest”
- CRSS files: Invoicing and billing, Intraday credit info, Statistical Framework, Eurosystem and Legal Archiving retrieval
- Files generated by the oversized management process

Note: To have details about the files payload, please have a look at UDFS book 1 (TARGET2 directory and oversized data files) and UDFS book 3 (other files). The latter one is available for CBs only.

For provisioning of the above mentioned files the generic functionality of the SWIFTNet FileAct service is used. All information needed on a technical level is provided in the standard documentation of SWIFT ("SWIFTNet Service Design Guide").

The service and the mandatory request type used for each category of file are listed below.

The services trgt.papss and trgt.crss are real time services, trgt.sfpapss and trgt.sfcrss are store and forward services. In the Customer test environment the related services are trgt.papss!p, trgt.sfpapss!p, trgt.crss!p and trgt.sfcrss!p.

⁸ Real time mode: The immediatly processing of operations and/or transactions as they occur including direct response from the system within the SWIFT timeframe of 60 seconds.

⁹ Store & Forward: the ICM server will deliver the file to Swift S&F in due time. Afterwards, it will be up to each participant/CB to organize the download of this file from the Swift S&F server (pulling on initiative of the participant/CB or pushing at the initiative of Swift S&F)

2.4.1 CB traffic: statistical data & general ledger

Category	Service	Request type
statistical application	trgt.papss	admi.xxx.target2.statzzz
general ledger	trgt.sfpapss	admi.xxx.target2.glyyy
general ledger TIPS (camt.053)	trgt.sfpapss	admi.xxx.target2.gltips

Where zzz = pmm, ham, sfm, rmm, com and yyy = pmm, ham, sfm, com¹⁰

2.4.2 Directory distribution/downloads

Category	Service	Request type
Directory update	trgt.papss	reda.xxx.target2.dirupdate
Full directory	trgt.papss	reda.xxx.target2.dirfull
Directory update	trgt.sfpapss	reda.xxx.target2.dirupdate

The service trgt.papss is used for the “pull mode” and trgt.sfpapss for the “push mode” (see UDFS book 1 Chapter 9.3.3)

2.4.3 End of period Interest

Category	Service	Request type
End of period interest	trgt.sfpapss	camt.xxx.target2.epi
End of period interest and fulfilment of compulsory reserve	trgt.sfpapss	camt.xxx.target2.epicr

2.4.4 CRSS

2.4.4.1 Invoicing Billing

Category	Service	Request type
Invoicing	trgt.sfcrss	admi.xxx.target2.invo
Billing	trgt.sfcrss	admi.xxx.target2.billzzz

¹⁰ com refers to Contingency module

where zzz = as, par, con

2.4.4.2 ECB info: intraday credit

Category	Service	Request type
Intraday credit info	trgt.sfcrrs	camt.xxx.target2.creditinfo

2.4.4.3 EURO system

Category	Service	Request type
Statistical Framework Eurosystem	trgt.sfcrrs	admi.xxx.target2.stateur

2.4.4.4 Legal Archiving retrieval

Category	Service	Request type
Legal Archiving retrieval	trgt.sfcrrs	admi.xxx.target2.arch

2.4.5 Oversized data management process

2.4.5.1 Real-Time mode

The oversized data management process described in UDFS Book 4 paragraph 2.1.3 works as follows:

1. TARGET2 answers to the Request InterAct message to inform the client that the requested information is available via FileAct. The answer message includes the name of the file to be retrieved by the client application (as it is an InterAct response it has no Request Type);
2. The client application requests the file via a Get File Request;
3. The TARGET2 sends the file to the client application

In case of Oversized Data the following Request types will be used:

Category	Service	Request type
2 - Client Get File message	trgt.papss	camt.xxx.target2.oversdata
3 - File sent by TARGET2	trgt.papss	camt.xxx.target2.oversdata

2.4.5.2 Store and Forward mode for ASI

For ASI the oversized data management process is executed in asynchronous mode. The InterAct message sent by the user is first acknowledged by TARGET2 and then later TARGET2 initiate an answer which is a Store and Forward InterAct Request possibly transformed in a Store and Forward FileAct transfer.

In case of Oversized data the following Request type will be used:

Category	Service	Request type
3 - File sent by TARGET2	trgt.sfpapss	Same as InterAct message ¹¹

¹¹ For ASI InterAct messages transferred via FileAct due to oversized data management, the FileAct request type will be the request type specified for the InterAct message (see UDFS Book 4 chapt. 4.3 Request Control).

2.5 Internal routing

Some functional and most technical messages are not related to a single module. These messages can be processed by more than one module. Since all external messages are exchanged with the central TARGET2 server, the messages must be addressed to a certain module. The TARGET2 server unpacks the XML messages and executes the request at their final destination.

For the routing of both functional and technical XML messages to the TARGET2 modules, the SWIFT Standard Application Header is applied. The Application Header takes the short name of the module (e.g. HAM, PM, ...). If by accident a message is addressed to the wrong module, the TARGET2 server will return an error message. The Application Header is applied for incoming and outgoing messages.

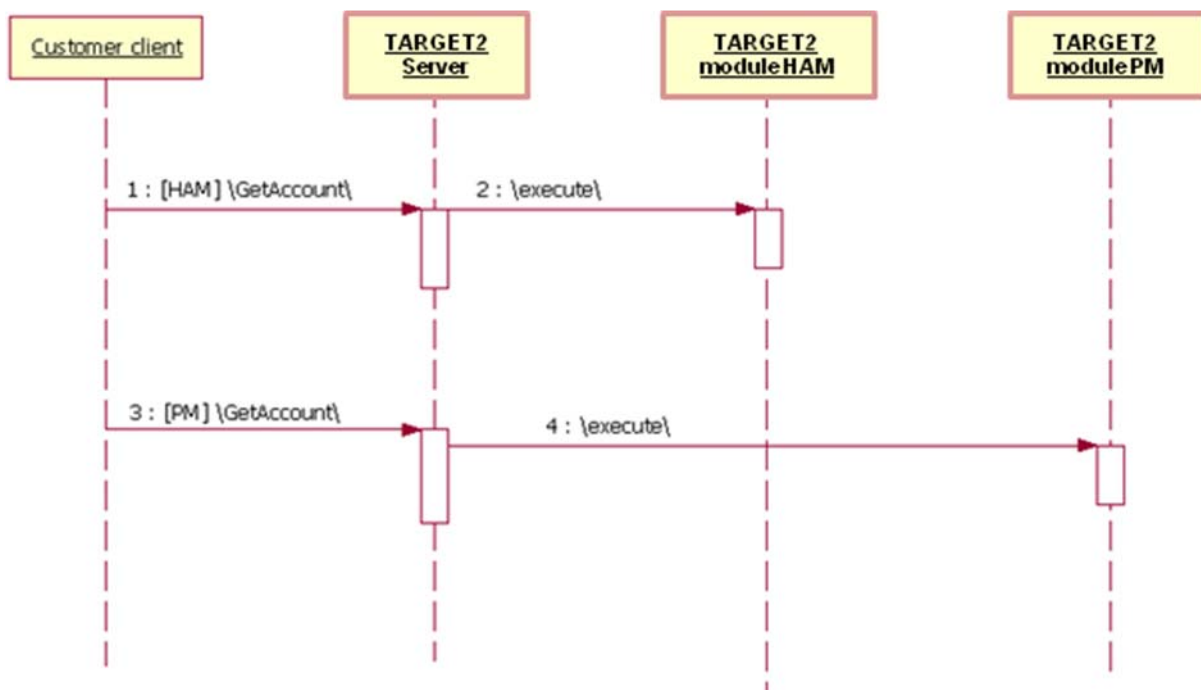

1. The message is addressed to the HAM module
2. The TARGET2 server executes the message at the HAM module.
3. An identical message is addressed to the PM module.
4. The TARGET2 server executes the message at the PM module.

2.6 Task Queue protocol

This chapter intends to give a general overview of the handling of the task queue. Even in A2A mode there is no “four eyes principle” in place the general approach should be transparent because it will be possible to “download” the entries in the Task Queue (including the status of each task) via A2A.

2.6.1 General issues

“Four eyes principle” means, that a task must be confirmed by a second user before it will be executed. Unlike this, a task in “two eyes principle” immediately takes effect on the processing.

The classification whether a task will be executed in “four eyes principle” or in “two eyes principle” depends on the RBAC roles of the individual user that are granted by the Security Officer of the customer application. The RBAC roles are automatically transferred with each request.

Due to the fact that A2A supports two different CAMT versions of Get/ReturnTask, the interaction between request and response message will look in the following way:

Interaction CAMT version 2012 (5.0):

Request GetTask <camt.998.001.03> [means CAMT version 2012 (5.0)]

Response ReturnTask <camt.998.001.03> [means CAMT version 2012 (5.0)] → the included tasks will be based on the messages, which belongs to version 2012 (5.0).

Recombination of Limit modification in A2A task-queue:

The repetition of several or a list of limit modifications in one request can not be considered in the ReturnTask message. It is not possible to re-combine the different tasks to the original message. Each task is displayed as a separate message. That means that for Limit modification PM and SDM create for each modification a separate task.

2.6.2 Task Queue

The implementation of the “four eyes principle” requires an asynchronous mechanism. All tasks are stored in a task queue, having assigned a changing status, and will be worked of step by step by the TARGET2 module or PHA. In four eyes mode, no task immediately takes

effect on the TARGET2 module or PHA. There is a separated task queue for each module and for PHA. T2SI is an exception as this module does not have an own task queue. It does not create tasks from XML payment messages (comparable to FIN payment messages) and stores other orders in the PM task queue. There is also no task queue management in CRISP and CRAKS3 as these two modules do not support 4 eyes principle.

The following table shows the status a task could take:

Status	Description	Transition possible to
toConfirm	The task must be confirmed by a second user and will not be processed.	processing, revoked, rejected
processing	The task is ready to be processed	waiting, pending, rejected, completed
waiting	The task processing is blocked due to a running algorithm. Only relevant for PM.	pending, rejected, completed
pending	Due to the current processing conditions the task can not be completed. Only relevant for PM.	revoked, rejected, completed
partiallyPending	The user's order cannot be processed completely (e.g. an increase of reservation cannot be executed completely because of lack of liquidity). His intention is taken into account as far as possible. The task will be updated and further processed, if the pre-conditions for the "partially pending" status (e.g. liquidity increase) are changed. Only relevant for PM.	revoked, completed
revoked	The task has been revoked by a user.	-
rejected	An error was detected.	-
completed	The task was processed successfully.	-

Note: Status "processing" is not envisaged for tasks related to SD. This because SD modification are processed immediately when requested.

The task queue serves for the processing of **all** tasks. Tasks to be handled in "four eyes principle" and "two eyes principle" are handled in equal manner.

The status "completed" means all validations by ICM and the related module are successfully processed. In most cases the status "complete" is (more or less) equal to the final processing of the task in the related module. There are only few tasks where the following processing of the task within the module might result in a pending status. Have a close look on the listed tasks "Tasks possibly pending after status completed" below:

Tasks possibly pending after status completed	reason for pending	affected participants in TARGET2/ probability
Agree payment of excluded participant	<i>if more than one person must approve</i>	CB if acting in 4-eyes modes / exclusion very rare
Agree file of an excluded AS	<i>if more than one person must approve</i>	CB if acting in 4-eyes modes / exclusion very rare

2.6.3 Task processing

All tasks are stored in the task queue of the individual modules or PHA. A reference to the task is generated by the TARGET2 module or PHA and returned to the requestor with the response. This is of course not applicable to CRISP and CRAKS3 where no task queue is managed.

The following activity diagram illustrates the status transitions for PM:

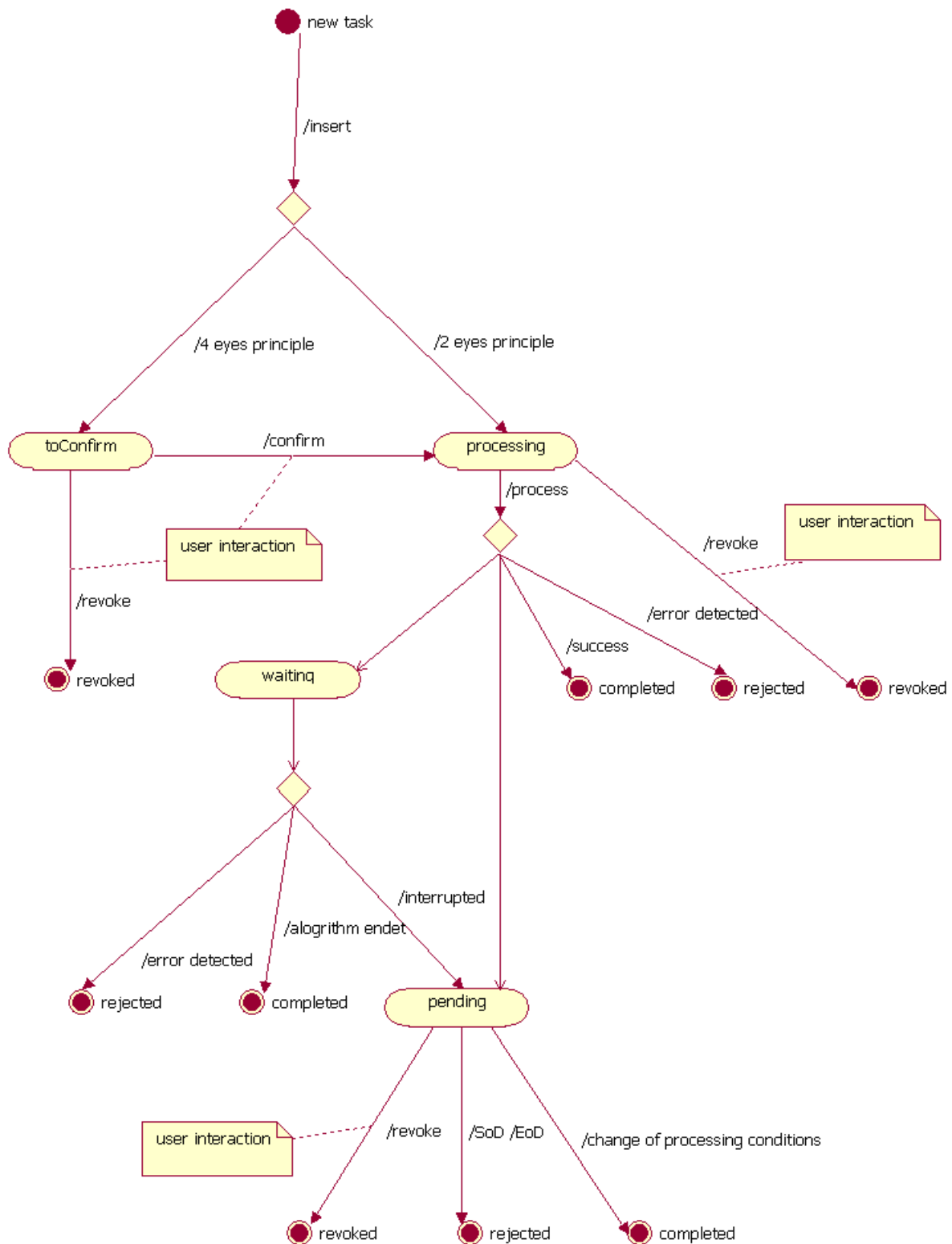

For all TARGET2 modules using task queues except SD when a new task is inserted in a task queue and is to be handled in “four eyes principle”, the task will be assigned the status “toConfirm”. The status “toConfirm” indicates that this request will not be processed and has to be confirmed by a second user of the same institute. When the request is confirmed, the status is set to “processing”. The status “processing” indicates, that the request is ready to be processed.

When a new task is inserted in a task queue and is to be handled in “two eyes principle”, the task will be immediately assigned the status “processing”.

All TARGET2 modules using task queues except SD are ongoing to scan their task queue for tasks in status “processing“. When a new task is detected, the task will be processed. But if an algorithm is running and the processing of the task is blocked the status of the task will be “waiting” (only PM). However this status will be assigned only for a short time. When the processing conditions prevent the task from completion the status will be set to “pending”. When anywhere during the processing a business error is detected, the status of the task is set to “rejected”¹² and if the task was processed successfully, the status will be set to “completed”.

In case of HAM, RM and SF tasks the status transitions are illustrated by the following activity diagram:

¹² If a technical error is detected, the request will not be stored in the task queue. The request will be rejected in an interactive mode.

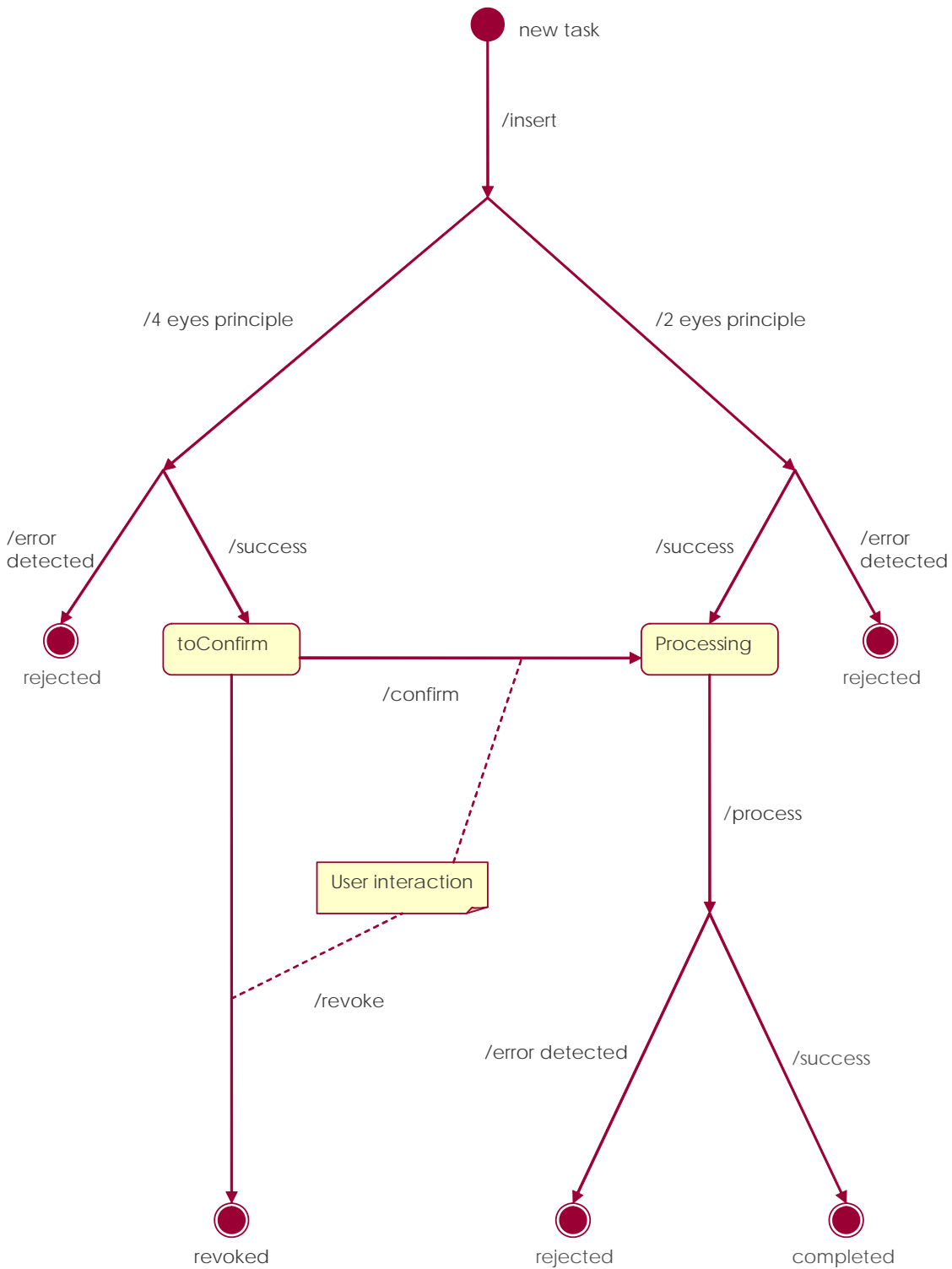

In the case of SD the task queue management is different from other modules. The main difference is that when a request is addressed to SD it is immediately processed and not queued in the task queue. There is therefore no task queue scanning. Task initiated in 4 eyes mode are created directly in “ToConfirm” status. Task initiated in two eyes mode are created directly in status “Completed”. In case of failure SD rejects the request as a whole including

the creation of the task. The information of the failure and the reason for the failures is provided directly in the Receipt. This is possible as SD requests are processed immediately.

The SD status transitions are illustrated by the following diagram:

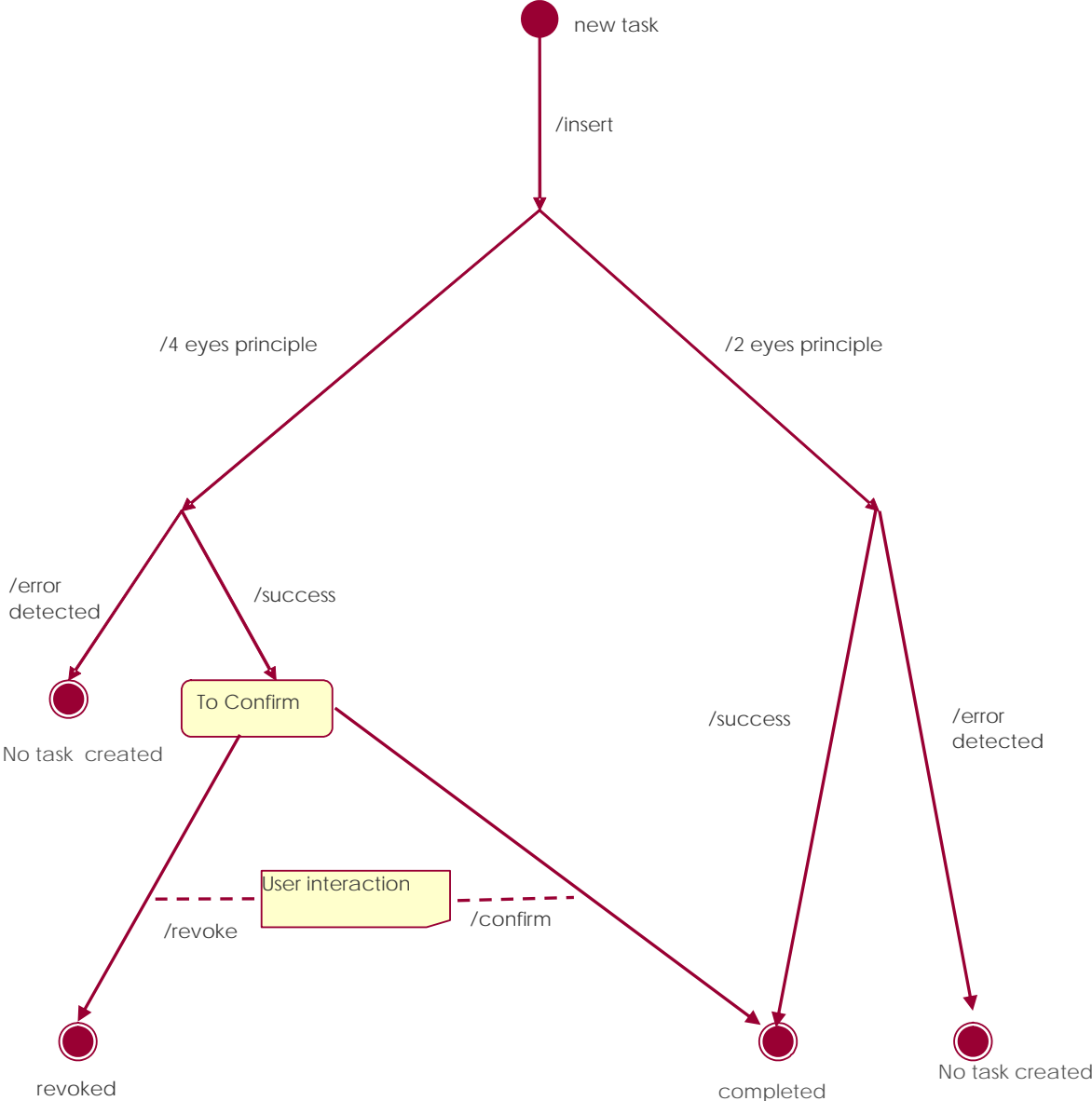

2.6.4 User action

2.6.4.1 Creation

A task is created by Modify, Cancel and similar messages. A request for modification creates a task in the task queue. Since a message can contain only one modification (except DeleteLimit and ModifyLimit messages), exactly one task is created per message. For the task a Receipt message is returned. The Receipt message contains a technical status code and a reference to the task. A positive Receipt message indicates that from technical point of view everything is fine at that the module accepted the request. In case of SD it also indicates that the request has been processed successfully.

2.6.4.2 Query

The users can query the task queues of the TARGET2 modules and PHA to monitor the processing. A user can enter a selection criterion and read the entries of all users of his institute. Typically a second user, that means not the one who captured the task, queries the task queue for the requests that have to be confirmed. When the status is “rejected” a business error will be reported.

2.6.4.3 Modification

If the status of a task is “toConfirm”, the (U2A) user has two opportunities to modify a task:

- The user can confirm the task (This action is restricted to those users, who have not captured the task.)
- The user can revoke the task (This action is restricted to those users, who have not captured the task.)

Modification operations are not applicable for A2A users. For the A2A mode the two eyes principle is foreseen only. If the users being connected to the TARGET2 server via an application (A2A) the four eyes principle must be implemented in the application developed by the customer.

2.6.4.4 Summary

The following sequence diagram illustrates the complete user interaction:

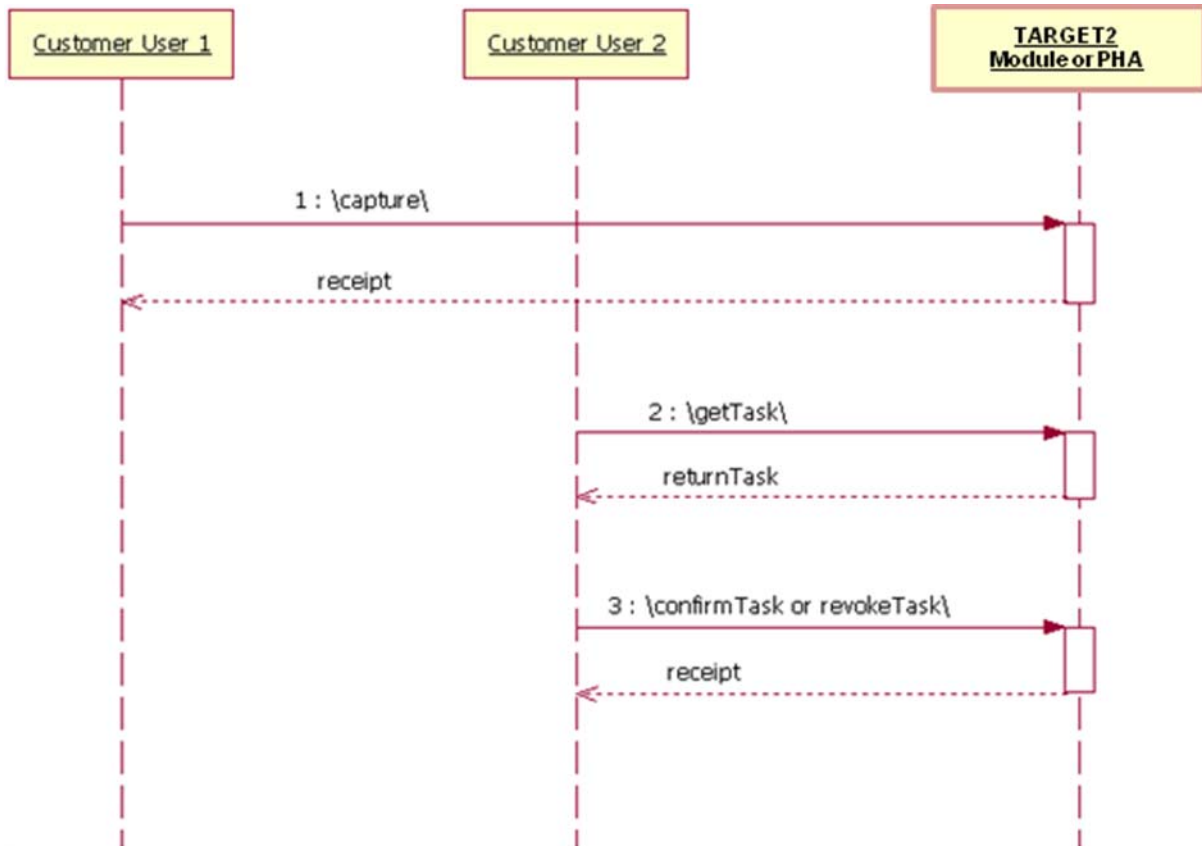

1. A first user captures a task and inserts the task into the task queue of the related TARGET2 module or PHA. The successful insertion is reported with a *Receipt* message and a related reference is returned.
2. A second user queries the task queue for those requests that have to be confirmed. The list of tasks is returned to the requestor. The task queue can be queried by the first user as well, typically with the related reference.
3. The second user confirms or revokes a task that has the status “to confirm”.

2.6.5 Sample “Task Queue”

The example shows a ReturnTask message, based on CAMT version 2012 (5.0). It reports on two tasks related to PM: ModifyLimit and ModifyTransaction. The document structure of reported tasks is not a copy of the original message the user sent. It could even have been sent in the new CAMT version 2017.

The ModifyLimit task has been rejected. The ModifyTransaction task has been completed successfully.

Both have been inserted by a user with the DN “cn=Josef,ou=tssp,ou=markdeff,o=swift”.

The module “PM” is indicated in the SWIFT Standard Application Header.

```
<AppHdr xmlns="urn:swift:xsd:$ahV10">
  <From>
    <Type>NAME</Type>
    <Id>PM</Id>
  </From>
  <MsgRef>void</MsgRef>
  <CrDate>2013-01-01T12:12:00</CrDate>
</AppHdr>
<Document xmlns="urn:swift:xsd:camt.998.001.03">
  <PrtryMsg>
    <MsgHdr>
      <MsgId>ABCDEFGHIJKLMNOPQRSTUVWXYZ123456789</MsgId>
    </MsgHdr>
    <Rltd>
      <Ref>ABCDEFGHIJKLMNOPQRSTUVWXYZ123456789</Ref>
    </Rltd>
    <PrtryData>
      <Tp>ReturnTask</Tp>
      <Data>
        <SspPrtryDt>
          <BizRpt>
            <TskRpt>
              <TskRef>
                <RltdRef>
                  <Ref>TaskIdentification1</Ref>
                </RltdRef>
              </TskRef>
              <Tsk>
                <TskNtry>
                  <NtryDt>
                    <DtTm>2013-01-01T12:00:00.000+01:00</DtTm>
                  </NtryDt>
                </TskNtry>
                <TskQSts>
                  <TskSts>rejected</TskSts>
                  <TskStsRsn>
                    <ErrCd>2862</ErrCd>
                    <Desc>Request out of cut-off or time</Desc>
                  </TskStsRsn>
                  <LstUsr>cn=Josef,ou=tssp,ou=markdeff,o=swift</LstUsr>
                </TskQSts>
              </Tsk>
            </TskRpt>
          </BizRpt>
        </SspPrtryDt>
      </Data>
    </PrtryData>
  </PrtryMsg>
  <Document xmlns="urn:swift:xsd:camt.011.001.05">
    <ModifyLmt>
      <MsgHdr>
        <MsgId>void</MsgId>
      </MsgHdr>
      <LmtDtIs>
        <LmtId>
          <Cur>
            <Tp>
              <Cd>MULT</Cd>
            </Tp>
            <AcctOwnr>
              <FinInstnId>
                <BICFI>MARKDEFF</BICFI>
              </FinInstnId>
            </AcctOwnr>
          </Cur>
        </LmtId>
      </LmtDtIs>
    </ModifyLmt>
  </Document>
</Document>
```

```

        </FinInstnId>
        </AcctOwnr>
        </Cur>
        </LmtId>
        <NewLmtValSet>
        <Amt>
        <AmtWthtCcy>1000000</AmtWthtCcy>
        </Amt>
        </NewLmtValSet>
        </LmtDtIs>
        </ModifyLmt>
    </Document>
</Tsk>
</TskRpt>
<TskRpt>
    <TskRef>
        <RltdRef>
        <Ref>TaskIdentification2</Ref>
        </RltdRef>
    </TskRef>
    <Tsk>
        <TskNtry>
        <NtryDt>
        <DtTm>2013-01-01T12:00:00.000+01:00</DtTm>
        </NtryDt>
        </TskNtry>
        <TskQSts>
        <TskSts>completed</TskSts>
        <LstUsr>cn=Josef,ou=tspp,ou=markdeff,o=swift</LstUsr>
        </TskQSts>
        <Document xmlns="urn:swift:xsd:camt.007.001.05">
            <ModifyTx>
                <MsgHdr>
                <MsgId>void</MsgId>
                </MsgHdr>
                <Mod>
                    <PmtId>
                    <PrtryId>123456789012345</PrtryId>
                    </PmtId>
                    <NewPmtValSet>
                    <PrcgVldtyTm>
                    <ToDtTm>2013-01-01T12:35:30</ToDtTm>
                    </PrcgVldtyTm>
                    </NewPmtValSet>
                </Mod>
            </ModifyTx>
        </Document>
    </Tsk>
</TskRpt>
</BizRpt>
</SspPrtryDt>
</Data>
</PrtryData>
</PrtryMsg>
</Document>

```

The following example shows a ReturnTask message, based on CAMT version 2012 (5.0). It reports on two tasks related to PM: ModifyLimit and ModifyTransaction. The document structure of reported tasks is not a copy of the original message the user sent. It could even have been sent in the new CAMT version 2017.

The ModifyLimit task has been rejected. The ModifyTransaction task has been completed successfully.

Both have been inserted by a user with the DN “cn=Josef,ou=tspp,ou=markdeff,o=swift”. The module “PM” is indicated in the SWIFT Standard Application Header.

```
<AppHdr xmlns="urn:swift:xsd:$ahV10">
```

```

<From>
  <Type>NAME</Type>
  <Id>PM</Id>
</From>
<MsgRef>void</MsgRef>
<CrDate>2007-01-01T12:00:00</CrDate>
</AppHdr>
<Document xmlns="urn:swift:xsd:camt.998.001.02">
  <PrtryMsg>
    <Msgld>
      <Ref>ABCDEFGHIJKLMNOPQRSTUVWXYZ123456789</Ref>
    </Msgld>
    <Rltd>
      <Ref>ABCDEFGHIJKLMNOPQRSTUVWXYZ123456789</Ref>
    </Rltd>
    <PrtryData>
      <Tp>ReturnTask</Tp>
      <SspPrtryDt>
        <BizRpt>
          <TskRpt>
            <TskRef>
              <RltdRef>
                <Ref>TaskIdentification1</Ref>
              </RltdRef>
            </TskRef>
            <Tsk>
              <TskNtry>
                <NtryDt>
                  <DtTm>2007-01-01T12:00:00.000+01:00</DtTm>
                </NtryDt>
              </TskNtry>
              <TskQSts>
                <TskSts>rejected</TskSts>
                <TskStsRsn>
                  <ErrCd>2862</ErrCd>
                  <Desc>Request out of cut-off or time</Desc>
                </TskStsRsn>
                <LstUsr>cn=Josef,ou=tssp,ou=markdeff,o=swift</LstUsr>
              </TskQSts>
              <Document xmlns="urn:swift:xsd:camt.011.001.04">
                <ModifyLmt>
                  <Msgld>
                    <Id>void</Id>
                  </Msgld>
                  <LmtDtIs>
                    <CurLmtId>
                      <Tp>MULT</Tp>
                      <AcctOwnr>MARKDEFF</AcctOwnr>
                    </CurLmtId>
                    <NewLmtValSet>
                      <Amt>
                        <AmtWthtCcy>1000000</AmtWthtCcy>
                      </Amt>
                    </NewLmtValSet>
                  </LmtDtIs>
                </ModifyLmt>
              </Document>
            </Tsk>
          </TskRpt>
        </BizRpt>
      </SspPrtryDt>
    </PrtryData>
  </PrtryMsg>
  <TskRef>
    <RltdRef>
      <Ref>TaskIdentification2</Ref>
    </RltdRef>
  </TskRef>
  <Tsk>
    <TskNtry>
      <NtryDt>
        <DtTm>2007-01-01T12:00:00.000+01:00</DtTm>
      </NtryDt>
    </TskNtry>
    <TskQSts>
      <TskSts>completed</TskSts>
      <LstUsr>cn=Josef,ou=tssp,ou=markdeff,o=swift</LstUsr>
    </TskQSts>
    <Document xmlns="urn:swift:xsd:camt.007.001.04">
      <ModifyTx>

```

```
<MsgId>
  <Id>void</Id>
</MsgId>
<Mod>
  <InstrRef>
    <LngBizId>
      <PmtInstrRef>ABC1234</PmtInstrRef>
      <IntrBkSttlmAmt>100.15</IntrBkSttlmAmt>
      <IntrBkValDt>2007-02-25</IntrBkValDt>
      <PmtMtd>
        <FINMT>103</FINMT>
      </PmtMtd>
      <InstgAgtId>CHASUS33</InstgAgtId>
      <InstdAgtId>MARKDEFFXXX</InstdAgtId>
      <RltdRef>ABC12134</RltdRef>
    </LngBizId>
  </InstrRef>
  <NewPmtValSet>
    <PrcgVldtyTm>
      <ToDtTm>2004-07-21T09:35:30</ToDtTm>
    </PrcgVldtyTm>
  </NewPmtValSet>
</Mod>
</ModifyTx>
</Document>
</Tsk>
</TskRpt>
</BizRpt>
</SspPrtryDt>
</PrtryData>
</PrtryMsg>
</Document>
```

2.7 Treatment of modified data (delta set)

2.7.1 General issues

In order to avoid the transmission of redundant information TARGET2 offers the opportunity to reduce the data returned in the XML response. This feature is compliant to the SWIFT Cash Management Standard.

The business data compression is only implemented for the *ReturnTransaction* message.

The compressed business data is provided as delta sets. A delta set can occur with three different characteristics:

- Query type “CHNG”: Only new matching items are queried.
- Query type “MODF”: Only modified items are queried.
- Query type “DELD”: Only deleted items are queried.

The provisioning of delta sets requires an initialisation with a statement of search criteria. Once a delta set is initiated the search and return criteria of the initial request apply to all following requests referring to that delta set. The criteria cannot be modified. There is no limitation regarding the number of delta requests but the timeframe within they can be sent is limited to the current business day. With the beginning of a new business day the customer has to initialise new delta sets because TARGET2 deletes the queries during the end-of-day processing.

Delta requests with the three different characteristics mentioned above can refer to the same delta set. TARGET2 calculates the delta set again and again as difference between the current query and the respective previous queries.

A customer client application can calculate from their local data and the delta set the same data set that is available on the TARGET2 site. The course of operations at customer site is as follows:

1. Send an initialisation request
2. Receive the initialisation response
3. Send a delta request
4. Receive the delta response
5. Calculate the updated local data

6. Be idle. The idle time is not restricted. However, the time depends on the speed of the modifications and is thus different for each customer. The recommendation is 2-60 minutes.
7. Repeat the delta request. This is the same request as in number 3.

In the exceptional case that the initial request or one of the delta requests cannot be answered in time (a second level timeout occurs) and the requestor gets error 1005 – “Data not available” the customer has to send a new initialisation message.

2.7.2 Initialisation of the Delta Set

The delta set is initiated with a request that states a new transaction search and return criteria. In the response to this initial request TARGET2 returns a query name. This query name is the reference to the stated transaction search and return criteria. Each subsequent request that refers to this query name invokes at TARGET2 site a query with the referenced search criteria. The customers can initiate as many queries as required in parallel.

Once a delta set is initiated the subsequent delta set queries can be repeated indefinitely till the end-of-day. TARGET2 clears the queries during the end-of-day processing, so that the queries must be initialised once more at the beginning of the next business day.

Example

Step 1: Initial *GetTransaction* message with query type ALLL, sent by the user

MsgId	XYZ	<i>assigned by the user</i>
QryTp ¹³	ALLL ¹⁴	
QryNm ¹⁵	Void	<i>This element is not used in the initial request message.</i>
NewCrit ¹⁶	<i>any query</i>	<i>e.g. PdgSts = PSTL</i>

¹³ Specifies the nature of the query

¹⁴ The delta set can also be initialised with any other query type. However if QryTp=MODF and QryTp=DELD are used the result is ‘no payment found’.

¹⁵ Name of the query

¹⁶ Defines the criteria on which the information is extracted.

Step 2: *ReturnTransaction* message, returned to the user

MsgId	1	<i>assigned by TARGET2</i>
QryRef	XYZ	<i>reference to previous GetTransaction message</i>
QryNm	ABC	<i>assigned by TARGET2 (always when NewCrit is stated¹⁷)</i>

InstrRef ¹⁸	Amount	PdgSts	FnISts	Prty
111111	12.00	PSTL		high
222222	20.00	PSTL		normal
333333	30.00	PSTL		normal
444444	21.00	PSTL		low
555555	17.00	PSTL		low

2.7.3 Query Type “CHNG”

Once the delta set is initialised (2.7.2) the returned data can be reduced to the new matching items.

The delta set is calculated by comparing the current query result with the result of previous queries stored to the used reference (=query name)

In the response the items are returned in coherence with the return criteria stated in the initial request.

Example

Step 3: *GetTransaction* message, sent by the user

MsgId	Y1	<i>assigned by the user</i>
QryTp	CHNG	<i>instruction for TARGET2 to store the result of the query</i>
QryNm	ABC	<i>taken from initial ReturnTransaction message, indicates that the same query as in Step 1 should be executed again</i>
NewCrit	Void	

¹⁷ The query name is returned and can be used independently from the query type

¹⁸ Unique and unambiguous identification of a payment transaction, as assigned by SSP

Step 4a: Result of the query at TARGET2 site, *blue italics* indicate all modifications

Line No.	InstrRef	Amount	PdgSts	FnlSts	Prty
1	<i>666666</i>	<i>12.00</i>	<i>PSTL</i>		<i>high</i>
2	<i>4111111</i>	<i>12.00</i>		<i>STLD (former PSTL)</i>	<i>high</i>
3	222222	20.00	PSTL		normal
4	333333	30.00	PSTL		normal
5	555555	17.00	PSTL		<i>normal</i>
6	444444	21.00	PSTL		low

- Line 1 shows a new transaction.
- The transaction listed in line 2 does not fulfil the search criteria any longer because it is already settled. So it is deleted from the result set. Note, this transaction would be returned in case of query type DELD.
- The transaction in line 5 was already included in the response to the initial request. This transaction still fulfils the search criteria but another attribute (the priority) has changed. To get this modification a different request with query type MODF would be necessary.

Step 4b: ReturnTransaction message, returned to the user

Msgld	2	<i>assigned by TARGET2</i>
QryRef	Y1	<i>reference to previous GetTransaction message</i>
QryNm	ABC	<i>no changes, because NewCrit is void</i>

Report of new matching items:

InstrRef	Amount	PdgSts	FnlSts	Prty
666666	12.00	PSTL		high

2.7.4 Query Type “MODF”

Once the delta set is initialised (2.7.2) the returned data can be reduced to the modified items. First of all these items have already been reported with the same query name. (New items are not included.) They still have to match to the initial search criteria but have at least one attribute that has a changed value.

Although new items are not included in the result set of this query type the transactions observed is not limited to those that were reported for the initial request. It is possible to

combine all query types with the same query name in order to take into consideration new items (query type = CHNG) or drop deleted items (query type = DELD) for the following requests for modified transactions. Therefore it is not necessary to initialise delta sets with the same search criteria once more.

For sure the responses show snapshots of current values. It is only possible to recognise changes of transaction attributes if previous values have already been reported (for earlier requests).

In the response only the reference and the modified attributes of the items are returned.

As long as the Instruction Reference may not only be related to a single transaction it can occur several times in the response. To receive the information which of the transactions had been modified it is necessary to send a further request querying the InstrRef.

Implementation remarks:

- *The calculation of modified items considers all attributes of an item. Also attributes that are not indicated as return criteria are considered. Example: In ReturnCriteria the status of the payment is excluded. But anyway, when the status has changed the payment is reported as 'modified' item. However, the new status will not be returned.*

Example

Step 3: *GetTransaction* message, sent by the user

MsgId	Y2	<i>assigned by the user</i>
QryTp	MODF	<i>instruction for TARGET2 to store the result of the query</i>
QryNm	ABC	<i>taken from initial ReturnTransaction message, indicates that the same query as in Step 1 should be executed again</i>
NewCrit	Void	

Step 4a: Result of the query at TARGET2 site, *blue italics* indicate all modifications

InstrRef	Amount	PdgSts	FnISts	Prty
666666	<i>12.00</i>	<i>PSTL</i>		<i>high</i>
4111111	<i>12.00</i>		<i>STLD</i> <i>(former PSTL)</i>	<i>high</i>
222222	20.00	PSTL		normal
333333	30.00	PSTL		normal
555555	17.00	PSTL		<i>normal</i>
444444	21.00	PSTL		low

Step 4b: *ReturnTransaction* message, returned to the user

MsgId	3	<i>assigned by TARGET2</i>
QryRef	Y2	<i>reference to previous GetTransaction message</i>
QryNm	ABC	<i>no changes, because NewCrit is void</i>

Report of items that have changed:

InstrRef	Amount	PdgSts	FnISts	Prty
555555				<i>normal</i>

2.7.5 Query Type “DELD”

Once the delta set is initialised (2.7.2) the returned data can be reduced to the deleted items. These are all items that have been reported for the stated query name (within the response to the initial request or subsequent requests for new matching items) but do not match to the search criteria any more. When a transaction is reported as deleted this can only occur once more if it is reported as new item for the same query name again. (E.g. if the search criteria is ‘urgent payments’, the priority of a payment changed to ‘normal’ and reverse.)

In the response only the reference and no attribute of the deleted items is returned.

Example

Step 3: *GetTransaction* message, sent by the user

MsgId	Y3	<i>assigned by the user</i>
QryTp	DELD	<i>instruction for TARGET2 to store the result of the query</i>
QryNm	ABC	<i>taken from initial ReturnTransaction message, indicates that the same query as in Step 1 should be executed again</i>

NewCrit	Void	
---------	------	--

Step 4a: Result of the query at TARGET2 site, *blue italics* indicate all modifications

InstrRef	Amount	PdgSts	FnISts	Prty
<i>666666</i>	<i>12.00</i>	<i>PSTL</i>		<i>high</i>
<i>411111</i>	<i>12.00</i>		<i>STLD</i> <i>(former PSTL)</i>	<i>high</i>
222222	20.00	PSTL		normal
333333	30.00	PSTL		normal
555555	17.00	PSTL		<i>normal</i>
444444	21.00	PSTL		low

Step 4b: *ReturnTransaction* message, returned to the user

MsgId	4	<i>assigned by TARGET2</i>
QryRef	Y3	<i>reference to previous GetTransaction message</i>
QryNm	ABC	<i>no changes, because NewCrit is void</i>

Report of deleted items:

InstrRef	Amount	PdgSts	FnISts	Prty
111111				

2.8 Security

2.8.1 Role Based Access Control

2.8.1.1 General issues

Requests will only be executed, if the required RBAC role is in the list of RBAC roles that are sent with each request. If the list of RBAC roles does not match the requirement, the request will be rejected with a technical error message.

RBAC only applies to real-time services (trgt.papss!p and trgt.papss) used by ICM and T2SI. For other services there are no RBAC roles available. In those cases, the requestor's access rights are checked on basis of his DN and the participant information stored in static data, matching to his DN.

2.8.1.2 User roles for A2A

For ICM A2A there are four user roles in place. A fifth role is reserved for T2SI and must not be used for ICM requests. The roles reflect that different types of actors (credit institutions, ancillary systems, central banks and T2S Actors in TARGET2 authorised by the direct PM participant to act on his behalf) can use the A2A. The following user roles are in place:

Name of user role	Abbreviation	Participants being able to use the user role
Application for credit institutions (2-eyes-principle)	APPLICATE	Credit Institutions
Application for ancillary systems (2-eyes-principle)	APPLIASTE	Ancillary Systems
Application for central banks (2-eyes-principle)	APPLICBTE	Central Banks

Applications using one of the above mentioned user roles will have access via ICM to the following modules:

- Payments module (PM)
- Home Accounting module (HAM)
- Static Data module (SD)
- Standing Facilities module (SF)
- Reserve Management module (RM)
- Ancillary System Interface (ASI)
- Proprietary Home Accounting module (PHA)

Applications using one of the following user roles will have direct access to module T2SI:

Name of user role	Abbreviation	Actors being able to use the user role
Application for credit institutions (2-eyes-principle)	APPLICATE	Credit Institutions
Application for central banks (2-eyes-principle)	APPLICBTE	Central Banks
Application for T2S Actors in TARGET2 working on behalf of participants (2-eyes-principle)	APPLICDTE	T2S Actors in TARGET2 (eg CSDs and other credit institutions)

Central banks will also have access to the Contingency Module using A2A.

For further details please have a look at chapter 7.1 (= annex 1).

In the static data of TARGET2 it is stored whether a BIC, matching with the DN transmitted in a request, belongs to a credit institution, ancillary system, central bank or a T2S Actor in TARGET2. Therefore it can be guaranteed that e.g. an application of a credit institution does not have access to information which should be available for central banks only.

In the A2A approach no 4-eyes-principle is foreseen because this would mean that a task initiated by an application has to be confirmed by a second application. This does not seem to be an appropriate behaviour and does not match with the user requirements.

If a participant wants to limit the rights of users accessing the ICM via A2A or wants to follow the 4-eyes-principle, he has to implement it in his back-office application.

2.8.1.3 Error codes

ICM and T2SI will return one of the following error codes in case an error is detected when checking the RBAC roles:

Error code				Description	Remark
SSP	Y-copy	V-shape	XML		
X41	-	-	1401	No permission. RBAC User role(s) are not sufficient.	The user must have assigned the following roles within TARGET2 environment. APPLICATE for CI APPLICBTE for CB APPLIASTE for AS APPLICDTE for T2S Actors in TARGET2 (eg CSDs)
X43	-	-	1403	No permission. At least one RBAC role is reserved in A2A mode only but used in U2A.	U2A user is not allowed to use the A2A RBAC roles.
X49	-	-	1409	No permission. At least one RBAC role is reserved in U2A mode only but used in A2A.	A2A application is not allowed to use the U2A RBAC roles.
X55			1415	No permission. A combination of different A2A roles is not allowed.	A2A application cannot belong to different types of T2 actors at the same time.

2.8.2 Non-Repudiation of Emission

Non-repudiation of emission is mandatory for some requests (details see chapter 4.3 'Request control'). When for these requests non-repudiation of emission is not applied they are rejected by TARGET2 with a technical error message.

Remark: When non-repudiation of emission is applied the request payload must be signed (Requested by SWIFT).

3 Error codes

3.1 TARGET2 communication error codes

With the support of the ICM timeout for all ICM requests (divisible between U2A requests and A2A requests) the following time limits are intended:

For A2A requests: 290 sec.

For U2A requests: 120 sec.

In case requests can not be executed within the mentioned time limit, TARGET2 will generate or rather provide the following error to the related customer / application:

SSP Error Code: 801

Y-copy Error Code: A1

Shape Error Code: XI59

XML Error Code: 2859

Error Text: Request Timed Out

List of Errors

Error code				Error Text
SSP	Y-copy	V-shape	XML	
SSP Communication				
800	A0	XI50		MAC-error input
801	A1	XI59	2859	Request Timed Out
T96			T096	Liquidity Transfer unsettled in TIPS but negative Receipt from TIPS is missing - reasons under investigation.
T98			T098	Liquidity Transfer unsettled in T2S but negative Receipt from T2S is missing - reasons under investigation.

3.2 Common error codes

Following the list of common error codes is shown. They are valid for all XML messages used by TARGET2. Therefore they are not repeated for each XML message described in chapter 6 of UDFS book 4. In some cases the error text will be enriched with additional detailed information.

Error code				Error Text
SSP	Y-copy	V-shape	XML	
SSP queueing				
600	L0	XI08	T600	Revocation of payment
601			PORV	Pending order revoked
610	L1	AM04	RDIB	Removal of payment because of missing cover or exceeding a limit. / Order rejected due to insufficient balance.
620	L2		EXSB	Exclusion of payment by PM / Exclusion Settlement Bank
630	L3			Rejection of user order because payment not queued anymore
640	L4		NNCL	Decrease must not lead to a negative credit line
650			PORO	Pending order replaced by new order
651	L5			CB closed or end-of-day-procedure in progress.

Error code				Error Text
SSP	Y-copy	V-shape	XML	
XML common status codes				
X01			1001	Execution timeout limit exceeded
X02			1002	Data not yet available
X03			1003	Message size limit exceeded
X04			1004	File size limit exceeded (Sw:RejectDescription)
X05			1005	Data not available
X07			1101	An application header must be sent with each message
X08			1102	The payload must not be empty
X09			1103	Processing not possible. Check addressed module and message
X11			1199	free text (parser output)
X22			9999	General system error
X40			1400	BIC must indicate a SSP participant
X43			1403	No permission. At least one RBAC role is reserved in A2A mode only but used in U2A
X46			1416	No access. There is more than one BIC assigned to the DN
X49			1409	No permission. At least one RBAC role is reserved in U2A mode only but used in A2A
X57			1417	Requestor DN not found in the DN matching table
X59			1419	No authorisation. Requestor may not initiate this order type.
X60			1420	"Work as" selection mandatory if DN is linked to several participants.
X65				You are not allowed to see further information
X70			1430	This request type has to be sent in real-time mode.
X71			1431	This request type has to be sent in store-and-forward mode.

Error code				Error Text
SSP	Y-copy	V-shape	XML	
XML operating status codes				
X00			0000	O.k.
X34			1304	No task-queue information found
X35			1305	The query name is not related to a previous query.

Error code				Error Text
SSP	Y-copy	V-shape	XML	
XML security status codes				
X10			1110	Missing mandatory signature or signature invalid
X41			1401	No permission. RBAC User role(s) are not sufficient.
X42			1402	No authorisation. User is not allowed acting on behalf of another participant.
X44			1404	If "non repudiation of emission" is mandatory, the NRE indicator flag has to be present
X45			1405	No authorisation or rather interaction not possible. User is not allowed acting on behalf of another participant as Group of Account manager
X47			1407	No authorisation. User is not allowed acting on behalf of another Participant as Central Bank
X48			1408	Interaction only possible for the virtual account manager
X51			1411	The selected participant is no Group of Accounts Manager
X52			1410	Debit and credit account do not belong to the same Group of Accounts.
X53			1412	Credit account does not belong to the debtor
X55			1415	A combination of different A2A roles is not allowed.
X58			1406	No authorisation. User is not allowed acting on behalf of another participant as T2S Actor in TARGET2.
X61			1421	Requestor DN not linked to the indicated working BIC.
X62	TL		1422	The DCA must be linked to a RTGS account related to the sender.
X63			1423	No authorisation. Requestor is no PM participant.
X64			1424	No authorisation. Requestor has insufficient actor type.
X66	TL		1426	The TIPS Account must be linked to a RTGS account related to the sender.

Error code				Error Text
SSP	Y-copy	V-shape	XML	
SSP related error codes				
D00				Unknown error
D01				Domestic RTGS system is down
D02				Delay too long
U01				Field 53/58 is not filled with BIC of CB
U02				Responsible CB of BIC in field 58 is not equal to CB in field 53
U03				BIC is not in the BIC Directory

3.3 Individual error codes

Following the list of individual error codes is shown. They are valid for some XML messages only. Therefore they are repeated for each XML message when describing the single XML message in chapter 6 of UDFS book 4. In some cases the error text will be enriched with additional detailed information. This will e. g. look as follows:

```
<Err>  
  <Prtry>P013</Prtry>  
</Err>  
<Desc>No payment found - failed to get a payment for the specified select criteria</Desc>
```

The list aims to give a global overview of all “other error codes”.

Error code				Error Text
SSP	Y-copy	V-shape	XML	
XML functional status codes (PM, PHA, ICM)				
850	B0	XI00	2850	Generic error
851	B1	XI11	2851	Message format error
852	B2	XI12	2852	Invalid character or invalid numeric value
853	B3	XI13	2853	Unexpected data
854	B4	XI14	2854	Invalid decimal value
855	B5	XI15	2855	Too many fields
856	B6	XI16	2856	Field too short
857	B7	XI17	2857	Field too long
858	B8	XI00	2858	Mandatory field not found
861	C1	RF01	2861	Double input
862	C2	TM01	2862	Request out of cut-off time
863	C3		NA	Direct debit not accepted from receiver
864	C4			Payments to CBs ECB account are not allowed
865		XI02	2865	Missing receiving legitimacy
866	C6	AC06	2866	Exclusion of participant
867	C7	XI00	2867	BIC debtor and creditor must be different
868	C8	XI19	2868	Invalid sending/receiving BIC
870	D0			Field 72 - Using of codeword /CONPAY/ is only allowed if a CB is sender of the message.
871	D1	DT01	2871	Backup payment is not allowed / Value date in past not allowed
872	D2	DT01	2872	Field 32A/30 - TARGET2 non working day or value date too far in the future
873	D3	XT03	2873	Field 32A/32B - Currency is not EUR
874	D4	XI11	2874	Field 56a - Invalid field option
875	D5	XI11	2875	Field 57a - Invalid field option or missing account number
876	D6	XI18	2876	Invalid using codeword TILTIME, FROTIME, CLSTIME, REJTIME
877	D7	XI11	2877	Field 52a - Invalid field option
878	D8		2878	Latest debit time (option A) is reached
879	D9		2879	Field 58 is not filled with HAM participant
880	E0			Field 53/ 58 must be filled with a BIC of a direct participant belonging to the sending CB if codeword /CONPAY/ is used
881	E1			Sequence B is only allowed once in case of connected payment MT204 as connected payment or addressed to an Internet-based participant.
882	E2			Field 72 - amount following codeword /CONPAY/ is missing or has wrong format
884	E4		2884	For definition or change of a credit line (also in case of connected payments) the related account must have the participant type CI and the account type NORMAL.
885	E5			Field 58 account line - For payments addressed to TRGTXEPMXXX no sub-account allowed.
886	E6			Liquidity transfers to sub-accounts, Technical account - procedure 6 real-time or T2S must be highly urgent.

Error code				Error Text
SSP	Y-copy	V-shape	XML	
887	E7			Wrong format or value of UTC shift
888	E8			Daylight procedure is closed
890	K0	XI24	2890	Field not allowed because debtor or receiver of the payment is in module HAM
891	K1	XT20	2891	Field 72 - using of codeword /MANPAY/ is only allowed if a CB is sender of the message
892	K2		2892	Field 52 must be filled with a BIC of a direct participant if codeword /MANPAY/ is used
893	K3		2893	Priority highly urgent not allowed for this kind of payment
894	K4		2894	Function is not allowed in the current business day phase
895	K5		2895	Message is unexpected unless T2S connection is activated
896	K6			Payments to ECB mirror accounts are not allowed
910			S100	No data available for selected criteria
911			S110	Access to selected data is not authorized
950			S500	Inconsistent data input
960			S600	The requested creation is not possible
970			S700	The requested deletion is not possible.
980			S800	The requested update is not possible.
998			S998	Technical SDM failure
999			S999	General SDM failure
I01			I001	Invalid multiple selection
I03			I003	Invalid type
I04			I004	Current status does not allow deletion of record
I05			I005	Invalid model
I07			I007	No participant found
I08			I008	No liquidity found
I09			I009	No account group found
I12			I012	No Central Bank found
I14			I014	No current maintenance period found
I19			I019	No DN found
I21			I021	No settlement type found
I32			I032	No contract found
I34			I034	No contract type found
I35			I035	No event type found
I41			I041	Interrupt
I46			I046	Not allowed to select the BIC
I51			I051	Not allowed to process the task
I52			I052	Selected participant is no Ancillary System
I54			I054	Not allowed to enter ticker
I55			I055	Selected participant is no SSP Operator

Error code				Error Text
SSP	Y-copy	V-shape	XML	
I57			I057	Illegal argument
I59			I059	No cut-off time found
I61			I061	Selected participant is no Co-Manager
I62			I062	Selected participant is no Central Bank
I67			I067	No opening time found
I69			I069	Invalid date or time
I70			I070	Missing task ID
I72			I072	Wrong task status
I73			I073	Not allowed to modify the task
I75			I075	Invalid CLOB size
I76			I076	Payment is related to an AS file
I77			I077	Select criteria too long
I79			I079	Invalid role combination
I80			I080	Message not repeatable
I81			I081	Selected participant is no Collateral Management System
I82			I082	Selected participant is no Internet-based participant
I83			I083	HAM participant is not allowed to enter a credit transfer
I84			I084	Signing process failed
I85			I085	Verifying process failed
I86			I086	User session conflict detected
I87			I087	Internet-based participant is not allowed to work via SWIFT
I88			I088	Only Internet-based participants are allowed to work via Internet
I89			I089	Session Timeout
I90			I090	General system requirements are not fulfilled
I91			I091	You are not allowed to enter this screen. Please ask for access via the defined procedures.
I92			I092	You are not allowed to use the contingency network.
I93			I093	Confirmation of task is not allowed via network different from the one used for entering the task.
P11			P011	A multilateral limit can only be defined or is valid if at minimum one bilateral limit towards another direct participant is defined
P38			P038	BICs have to be unique - A group member may only have one sequence number.
T00			SPAS	Liquidity transfer partially settled.
T10	TV		T010	T2S related value added service package required.
T20				Only possible if Push Liquidity message is sent to T2S.
T21				T2S Receipt already received.
T22				A competing order is being processed for this business case.
T23				Only possible if Pull Liquidity message is sent to T2S.

Error code				Error Text
SSP	Y-copy	V-shape	XML	
T24				Only possible if Push Liquidity message is sent to TIPS.
T25				TIPS Receipt already received.
T26				Only possible if Pull Liquidity message is sent to TIPS.
T32			T032	Invalid status code.
T33			T033	Invalid status category.
T40			T040	Double Message Identification.
T41			T041	Double Instruction Identification.
T42	C1		T042	Double End-to-End Identification.
T50	TU		T050	Transfer not supported. LT can only be from RTGS account to DCA and vice versa.
T51	T1		T051	Invalid debit account type.
T52	T2		T052	Invalid credit account type.
T53	TU		T053	Transfer not supported. LT can only be from RTGS account to TIPS Account and vice versa.
T54	T4			Field 58 - option A with existing credit account BIC is mandatory.
T55	T5			Field 58 account line - only a valid DCA number is allowed.
T56	T6		T056	Message type not supported.
T57	T7			If field 52 is used, option A with BIC of a direct participant is mandatory.
T58	T8			If field 52 account line is used, it must be filled with a valid RTGS account ID.
T59	T9			If field 53 is used, option A with BIC and account ID of a EURO DCA must be stated.
T60	T0			Field 72 - Invalid using code word.
T61	TC			Invalid code word - supported codes in F13C are: FROTIME, TILTIME, REJTIME
T62	C2		T062	Cut-off time for T2S transfers has reached.
T63	F3			F13C settlement times are only accepted if message is sent during day trade phase
T64	F4			F13C settlement times cannot be processed in case of Pull Liquidity from T2S
T65	C6		T065	Transfer of excluded participant rejected after disagreement from CB.
T66	C6		T066	Transfer of excluded participant rejected by EoD process.
T67	L1		T067	Immediate rejection due to insufficient liquidity.
T68	L1		T068	Rejection of payment by EoD process due to insufficient liquidity.
T70	TA			Amount has to be larger than zero.
T90			T090	No matching business case - invalid reference
T91			T091	Business case already closed.
T92			T092	Unexpected Receipt
T97	TS		TIPS	Rejected by TIPS - Details provided by TIPS error code
T99	TS		T2SR	Rejected by T2S - Details provided by T2S error code

Error code				Error Text
SSP	Y-copy	V-shape	XML	
AS specific				
A01			A001	Sender not allowed
A02			A002	AS missing or not allowed in InitiatingParty / SubjectDetails
A03			A003	Invalid date
A04			A004	Invalid ControlSum
A05			A005	Invalid NumberOfTransactions
A06			A006	Invalid PriorityType
A07			A007	Invalid SettlementModelType
A08			A008	SettlementModelType not allowed for the sender
A09			A009	Invalid InformationPeriodType
A10			A010	Invalid FromTime
A11			A011	Invalid ToTime
A12			A012	Invalid GroupIdentification
A13			A013	Invalid PaymentScheme code
A14			A014	FirstAgent not allowed
A15			A015	FirstAgent Domestic account not allowed
A16			A016	FinalAgent not allowed
A17			A017	FinalAgent Domestic account not allowed
A18			A018	FirstAgent and FinalAgent accounts must be different
A19			A019	Double GroupIdentification
A20			A020	Double payment identification
A21			A021	Value date in the past or too far in the future
A22			A022	Currency is not EUR
A23			A023	Sum of debit from Technical account is not equal to sum of credit to Technical account
A24			A024	Amount unavailable
A25			A025	DebitAccountOwner not allowed
A26			A026	CreditAccountOwner not allowed
A27			A027	Debit DomesticAccount not allowed
A28			A028	Credit DomesticAccount not allowed
A29			A029	The qualifier must be Formatted
A30			A030	Code unknown
A31			A031	Reference unknown
A32			A032	Invalid StatusCode
A33			A033	Inconsistency between SettlementModelType, FirstAgent and FinalAgent
A34			A034	Order or message out of sequence
A35			A035	Procedure already open
A37			A037	Cycle already open

Error code				Error Text
SSP	Y-copy	V-shape	XML	
A38			A038	Cycle already closed
A39			A039	AS excluded
A40			A040	The AS is not authorised to request a Connected payment.
A41			A041	Debtor BIC is not a published SWIFT BIC
A42			A042	Creditor BIC is not a published SWIFT BIC
A43			A043	Number of transactions too high.
A49			A149	It is not possible to revoke one single transaction in Model 4 and 5
A50			A050	Revoke is only usable for files referring to settlement procedure 4 and 5
A51			A051	Revoke is only possible if status of file is "information period".
A52			A052	File not found
A53			A053	Change settlement period is possible only if settlement period is defined
A54			A054	Requested time for end of settlement period is not possible before end of information period
A55			A055	Requested time for end of settlement period is not possible in the past
A56			A056	Related AS does not participate in settlement procedure 6 real-time
A57			A057	Final Agent must be a Technical account - procedure 6 real-time
A58			A058	Settlement bank is not allowed to address this Technical account -procedure 6 real-time
A60	A6			Message type not supported
A70			A070	Counterpart AS does not contain a valid AS BIC in relation with the sender.
A71			A071	Counterpart AS forbidden for transactions other than cross-AS settlement.
A72			A072	Debtor BIC is not a Settlement Bank linked to the real-time AS sender of cross-AS settlement.
A73			A073	Creditor BIC is not a Settlement Bank linked to the real-time AS receiver of cross-AS settlement.
A80			DPNS	Daylight settlement period has not started
A81			GALL	Lack of liquidity on the guarantee account
A82			GANR	AS decision to use the guarantee account was negative
A83			GENE	Generic error
A84			RJED	Payment Reject at end of day
A85			RJSP	The payment is rejected because the Settlement period time is reached
A86			RVOK	The payment has been revoked
A87			REVR	Rejection after reversing procedure
A88			RJCT	Payment initiation or individual transaction included in the payment initiation has been rejected.
A89			INVL	Invalid file or transaction
A90			COPS	Current order partially settled
A91			ACSC	Accepted, settlement completed
A92			EXAS	The file / transaction is rejected because the AS is excluded
A93			RJDA	File / transaction was revoked by the CB after disagreement.

Error code				Error Text
SSP	Y-copy	V-shape	XML	
A94			P6CC	AS with procedure 6 - real-time cannot close the procedure
P36			P236	Procedure already closed
P42			P212	Reference limited to 16 alphanumerical characters
P44			P214	FirstAgent not allowed
P46			P216	FinalAgent not allowed

Error code				Error Text
SSP	Y-copy	V-shape	XML	
XML functional status codes (PM, PHA, ICM)				
700			2700	Repeat Sending only possible for MT103, 202, 900 or 910
701			2701	Repeat Sending not possible at this status of the message
702				Start of algorithm already manually initiated
703			2708	Negative amounts are not allowed
704				You are not allowed to change the defined chronological order of the events. Please use another time.
705			2705	The address for liquidity removal is missing
706				The selected algorithm is currently deactivated in the algorithm parameters. The algorithm must be activated before the manual start.
869			2869	Backup to TARGET1 is no longer supported.
897	K7		2897	Message is unexpected unless TIPS connection is activated
P04			P004	If you want to select SWIFT fields in your preferences, you must select your own accounts.
P05			P005	You are not allowed to select the Internal Interlinking Reference
P06			P006	If you want to select SWIFT fields, you must select your own accounts.
P07			P007	If you want to search for PaymentInstructionStatusDateTime, you have to send one request per payment status.
P08			P008	You are not allowed to select the element Receiver Information
P09			P009	You are not allowed to select this broadcast status
P10			P010	The multiplicity of the element "Instr" and "PrcgVldtyTm" is unequal
P12			P012	Modification, setting or deletion of limits not possible
P13			P013	No payment found
P14			P014	No Limit found
P15			P015	No bilateral limit defined for Counter Party
P16			P016	No current Reservation found
P18			P018	No Business Day Data found
P20			P020	If you want to select SWIFT fields, select accounts you are responsible for.
P21			P021	Return criteria SWIFT fields can only be selected if the query refers to accounts you are responsible for.
P24			P024	No Broadcast Information found
P25			P025	Central Bank does not support the Proprietary Home Account interface
P26			P026	The Proprietary Home Account is not available
P27			P027	Generic error generated by PHA
P30			P030	Only one occurrence of the element <AcctOwnr> per message is allowed.
P31			P031	The modification or removal of a multilateral limit is allowed only once per message.
P32			P032	The same counterpart-BIC is only allowed not more than once per message.
P33			P033	Invalid use of <AllCurLmts> or <AllDfltLmts>.
P34			P034	Search criteria PmtFr/Mmbld and PmtTo/Mmbld are only allowed once per request.
P35			P035	Country code(s) in PmtFr/Ctry and PmtTo/Ctry must not differ.
P37			P037	You cannot set CreditDebitIndicator to TRUE if your query applies to several accounts.

Error code				Error Text
SSP	Y-copy	V-shape	XML	
P50			P050	If element <PmtInstrStsDtTm> is used, within <PmtInstrSts> it is only allowed to search for <FnlSts>STLD</FnlSts>.
P51			P051	BIC Bilateral Counterpart does not exist
P52			P052	BIC Bilateral Counterpart must not indicate a member of a Virtual Account.
P53			P053	RTGS account does not exist or is not valid
P54			P054	Sub-account does not belong to the RTGS account
P55			P055	Account does not exist or is invalid
P56			P056	Invalid credited account
P57			P057	Invalid debited account
P58			P058	Both credited and debited account are mandatory
P59			P059	Either credit account or debited account must be present
P60			P060	Only valid BICs are allowed.
P61			P061	For accounts without non-liability of cover, this function is not allowed
P62			P062	BIC must be valid and have an RTGS account.
P65			P065	Sub-account not known in PM or not connected with AS
P66			P066	The order was rejected because it was received after an end of procedure message (out of the procedure time frame).
P67	L6		P067	Liquidity on the debited account is not sufficient
P68	L7		P068	There is a highly urgent payment in the queue
P70			P100	Function is only possible for AS: "info period", all other: "warehoused", "pending" (but not for change earliest debit time) and "earmarked"
P71			P101	You are not allowed to revoke the payment(s)
P72			P102	Function is not available for AS payments
P73			P103	Function is not available for AS payments settlement procedure 5 and 6
P77			P107	Limit value must be 1 million or more. The value 0,00 is possible for deletion of limits.
P78			P108	Function is only available for status open-pending.
P80			P110	You are not allowed to increase/decrease the payment(s)
P81			P111	You are not allowed to change the priority of the payment(s)
P82			P112	You are not allowed to change the Earliest Debit Time of the payment(s)
P83			P113	You are not allowed to change the Latest Debit Time of the payment(s)
P85			P115	Requested time must be before closing time of SSP
P86			P116	Only one date for Execution Date is allowed
P87			P117	Only responsible Central Banks can agree or disagree to the settlement.
P88			P118	Function is only possible, if the status of payment/file is "accounting stopped due to exclusion" and the value date is the current business day.
P89			P119	New setting of earliest or latest debit time is not possible.
P91			P121	New Earliest DebitTime is after the permitted Latest DebitTime
P92			P122	New Latest Debit Time is before specified Earliest Debit Time
P93			P123	Requested time must be later than the current system time.

Error code				Error Text
SSP	Y-copy	V-shape	XML	
P94			P124	Requested time must be later than opening time of SSP
P95			P125	Date is not the current value date
P96	T3		P126	Date is not the current SSP business day
P97			P127	Initiator DN is the same as used in the underlying writing operation
P98			P098	Only the Central Bank of the excluded Settlement Bank or of the excluded Ancillary System can agree or disagree on this payment.
P99			P099	No authorisation. The GoA Manager has no longer access to payments of an excluded Participant, which was previously member of his GoA.
T93			T093	NAK received

Error code				Error Text
SSP	Y-copy	V-shape	XML	
HAM/SF/RM/CM specific				
H01		XI01	H001	Sender not allowed
H02		XI04	H002	Debit account not open
H03		XI07	H003	Sender not allowed to debit the specified account
H04	M4	XT16	H004	Operation not allowed (e.g. cross border)
H05		XI09	H005	Returned (cancelled) at end of the day
H06			H006	No data available (e.g. an empty list)
H07	M7		H007	Account not open
H08			H008	Requestor unknown
H09			H009	Parameter logical error <.>
H10	M1		H010	Data not found (request data does not exist)
H11			H011	Requested BIC unknown
H12			H012	Requested BIC missing in input
H13			H013	Requested field missing in input
H14			H014	Requested country code missing in input

4 Description of XML messages

4.1 Introduction

4.1.1 Global structure of an XML message

An XML message (Request / Response) consists of the following different blocks:

- **Request** (sent by the application of a participant to the TARGET2 server)

Name of the block	O(ptional) / M(andatory) by SWIFT
• Authorisation Context, Authenticator, and Requestor	M
• Request Control	M
• Request Header	M
• Payload <ul style="list-style-type: none"> • Application Header • Document 	O (but mandatory for TARGET2)
• Cryptographic Blocks	O
• Message Signature	O

- **Response** (received by the application of a participant from the TARGET2 server)

Name of the block	O(ptional) / M(andatory) by SWIFT
• Response Descriptor	M
• Response Header	M
• Payload Considerations <ul style="list-style-type: none"> • Application Header • Document 	O (but mandatory for TARGET2)

4.1.2 Example

Below an example of an XML request and response is given. Its aim is just to visualize the general structure of XML messages (= different blocks) used by TARGET2.

- Request

```
<?xml version="1.0" encoding="UTF-8"?>
<!DOCTYPE SwInt:ExchangeRequest SYSTEM 'Sw.dtd'>
<SwInt:ExchangeRequest>
  <SwSec:AuthorisationContext>
    <SwSec:UserDN>cn=anjadroenen,o=banknl2a,o=swift</SwSec:UserDN>
  </SwSec:AuthorisationContext>
  <SwInt:Request>
    <SwInt:RequestControl>
      <SwInt:RequestCrypto>TRUE</SwInt:RequestCrypto>
      <SwInt:NRIndicator>TRUE</SwInt:NRIndicator>
    </SwInt:RequestControl>
    <SwInt:RequestHeader>
      <SwInt:Requestor>ou=target2appl,o=banknl2a,o=swift</SwInt:Requestor>
      <SwInt:Responder>cn=interact,ou=prod,o=trgtxepm,o=swift</SwInt:Responder>
      <SwInt:Service>trgt.papss</SwInt:Service>
      <SwInt:RequestType>camt.009.001.04</SwInt:RequestType>
    </SwInt:RequestHeader>
    <SwInt:RequestPayload>
      <AppHdr xmlns="urn:swift.xsd:$ahV10">
        <To>
          <Type>NAME</Type>
          <Id>PM</Id>
        </To>
        <MsgRef>ABCDEFGHIJKLMNQRST1234567890</MsgRef>
        <CrDate>2006-11-29T08:20:00</CrDate>
      </AppHdr>
      <Document xmlns="urn:swift.xsd:camt.009.001.04">
        <GetLmt>
          <MsgId>
            <Id>ABC123456</Id>
          </MsgId>
          <LmtQryDef>
            <NewCrit>
              <SchCrit>
                <AcctOwnr>BANKNL2AXXX</AcctOwnr>
              </SchCrit>
            </NewCrit>
          </LmtQryDef>
        </GetLmt>
      </Document>
    </SwInt:RequestPayload>
  </SwInt:Request>
</SwInt:ExchangeRequest>
```

- Response

```

<?xml version="1.0" encoding="UTF-8"?>
<!DOCTYPE SwInt:ExchangeResponse SYSTEM 'trgt.dtd'>
<SwInt:ExchangeResponse>
  <SwInt:ResponseHandle>
    <SwInt:RequestDescriptor>
      <SwInt:SwiftRequestRef>SNL00123-2005-08-14T16:27:03.162976.216437Z
      </SwInt:SwiftRequestRef>
      <SwInt:SwiftRef>swi00001-2005-08-14T16:27:04.21408.014541Z
      </SwInt:SwiftRef>
      <SwInt:NonRep>
        <SwInt:NRTType>SVCOPT</SwInt:NRTType>
      </SwInt:NonRep>
    </SwInt:RequestDescriptor>
    <SwInt:ResponseDescriptor>
      <SwInt:SwiftResponseRef>SNL00321-2005-08-14T16:27:05.84574.244122Z
      </SwInt:SwiftResponseRef>
      <SwInt:NonRep>
        <SwInt:NRTType>SVCOPT</SwInt:NRTType>
      </SwInt:NonRep>
    </SwInt:ResponseDescriptor>
    <SwInt:ResponseHeader>
      <SwInt:Responder>ou=interact,o=trgtxepm,o=swift</SwInt:Responder>
    </SwInt:ResponseHeader>
    <SwInt:ResponsePayload>
      <AppHdr xmlns="urn:swift:xsd: $ahV10">
        <From>
          <Type>NAME</Type>
          <Id>PM</Id>
        </From>
        <MsgRef>ABCDEFGHJKLMNOPQRST1234567890</MsgRef>
        <CrDate>2007-01-01T12:00:00</CrDate>
      </AppHdr>
      <Document xmlns=" urn:swift:xsd:camt.010.001.04 ">
        <RtrLmt>
          <MsgId>
            <Id>ABC123456</Id>
          </MsgId>
          <BizQryRef>
            <QryRef>ABCDEFGHJKLMNOPQRSTUVWXYZabcdefghi</QryRef>
          </BizQryRef>
          <BizRpt>
            <CurLmt>
              <LmtId>
                <BillLmtCtrPtyId>
                  <BIC>BANKNL2AXXX</BIC>
                </BillLmtCtrPtyId>
                <Tp>BILL</Tp>
                <AcctOwnr>BANKNL2AXXX</AcctOwnr>
              </LmtId>
              <Lmt>
                <Amt>
                  <AmtWthtCcy>123456.12</AmtWthtCcy>
                </Amt>
                <CdtDbtInd>DBIT</CdtDbtInd>
              </Lmt>
            </CurLmt>
            <DfltLmt>
              <LmtId>
                <BillLmtCtrPtyId>
                  <BIC>BANKNL2AXXX</BIC>
                </BillLmtCtrPtyId>
                <Tp>MULT</Tp>
                <AcctOwnr>BANKNL2AXXX</AcctOwnr>
              </LmtId>
              <Lmt>
                <Amt>
                  <AmtWthtCcy>123456.12</AmtWthtCcy>
                </Amt>
                <CdtDbtInd>DBIT</CdtDbtInd>
              </Lmt>
            </DfltLmt>
          </BizRpt>
        </RtrLmt>
      </Document>
    </SwInt:ResponsePayload>
  </SwInt:ResponseHandle>
</SwInt:ExchangeResponse>

```

```
</Document>
</SwInt:ResponsePayload>
<SwSec:Crypto>
  <SwSec:CryptoInternal>oejq4h8Ugd .... </SwSec:CryptoInternal>
  <SwSec:CryptoDescriptor>
    <SwSec:MemberRef>ReqresponseHeader</SwSec:MemberRef>
    <SwSec:MemberRef>ResponsePayload</SwSec:MemberRef>
    <SwSec:MemberRef>ResponseDescriptor.SwiftResponseRef</SwSec:MemberRef>
    <SwSec:SignDN>cn=%34,o=trgtxepm,o=swift</SwSec:SignDN>
    <SwSec:CertPolicyId>1.3.21.6.1</SwSec:CertPolicyId>
  </SwSec:CryptoDescriptor>
</SwSec:Crypto>
</SwInt:ResponseHandle>
</SwInt:ExchangeResponse>
```

4.1.3 Correlation / referencing of XML messages

The following diagram shows the correlation / referencing of XML messages. The tag <Ref> present in Receipt, GetTask and ReturnTask contains the unique reference number within TARGET2. It is defined by TARGET2 itself. Please note, that original Message Id of the underlying message will **not** be forwarded within ReturnTask message.

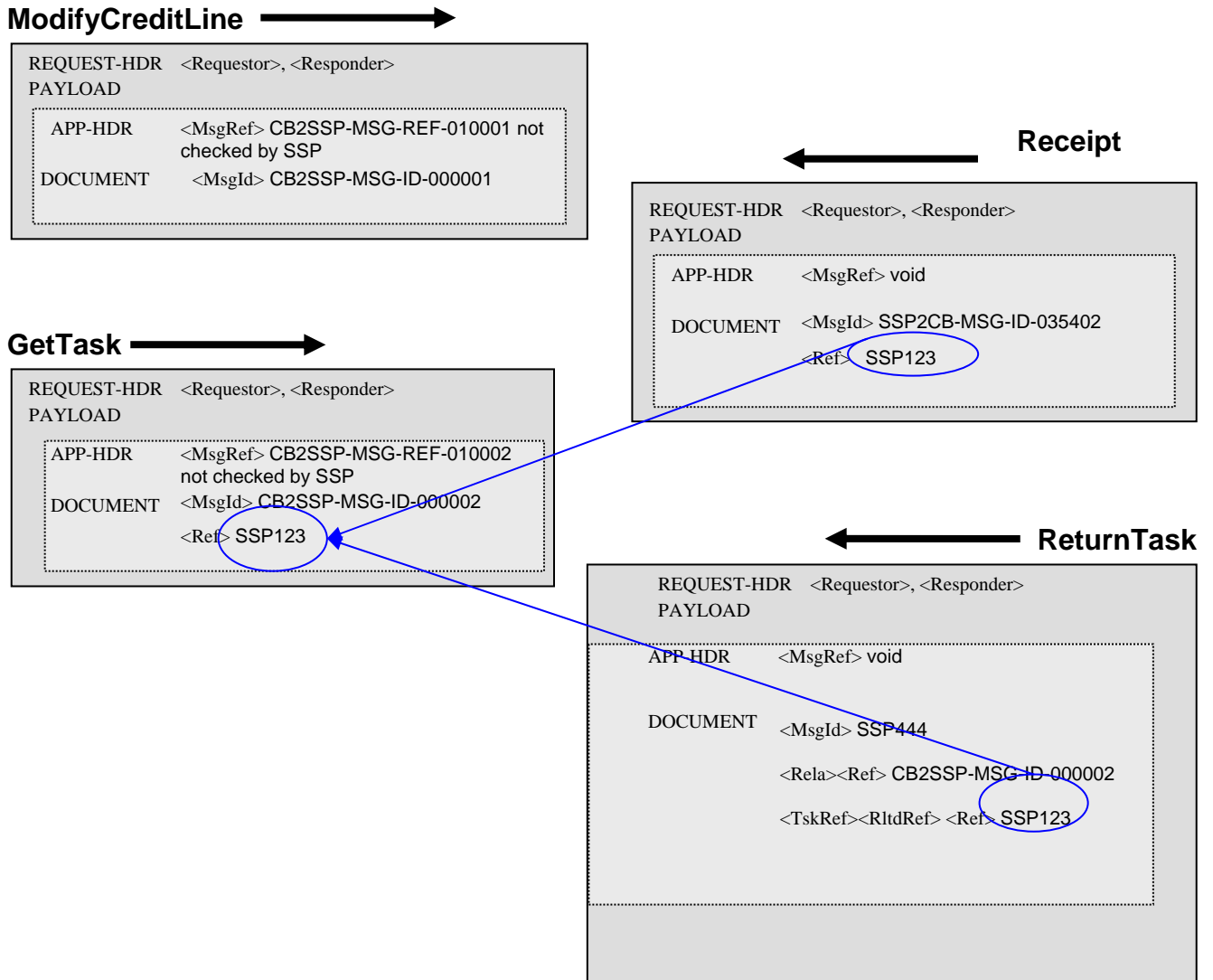

4.2 Authorisation Context, Authenticator, and Requestor

This block is mandatory by SWIFT. It contains the 'User Distinguished Name' (DN) of the entity that authorised the sending of the message. The User DN is a X.500 distinguished name, ending with

```
o=<BIC8>,o=swift
```

It is used by SWIFT to identify and authenticate the sending user. The sending user can be an operator (= human being) or an application certificate.

As this field is used for authorisation checks by SWIFT, this information is not forwarded to TARGET2 (= the recipient). It is also used by SWIFT for the RBAC checks and processing related to user roles (see ICM User Handbook I, chapter 3.2).

Example: BANKNL2A sends a XML request to TARGET2 using the following User DN

```
<SwSec:UserDN>cn=anjadroenen,o=banknl2a,o=swift</SwSec:UserDN>
```

4.3 Request control

This block is mandatory by SWIFT. It indicates vis-à-vis SWIFT whether the request

- contains cryptographic operations to be performed
- requires Non-Repudiation of Emission (NRE)¹⁹
- is to be handled by means of store & forward

In TARGET2 those requests require NRE which have 'writing access'; e.g. requests to initiate a liquidity transfer or to change data. For those requests the field <NRIndicator> must contain the value "TRUE". Otherwise the request will be rejected by the TARGET2.

¹⁹ Non-Repudiation of Emission (NRE) is a service feature offered by SWIFT. It makes sure the emission of a message cannot be denied by the emitting party.

All XML requests for which the use of NRE is mandatory are contained in the following list:

XML message related to ...	Request ²⁰	
Payments Module (PM)	BackupPayment_PM CancelTransaction_PM DeleteLimit_PM DeleteReservation_PM LiquidityCreditTransfer_PM ModifyCreditLine_PM ModifyLimit_PM ModifyReservation_PM ModifySequence_PM ModifyTransaction_PM ReleasePayment_PM	camt.023.001.06 or camt.023.001.04 camt.008.001.07 or camt.008.001.05 camt.012.001.06 or camt.012.001.05 camt.049.001.04 or camt.049.001.03 camt.050.001.04 or camt.050.001.03 camt.998.001.02 or camt.998.001.03 camt.011.001.06 or camt.011.001.05 camt.048.001.04 or camt.048.001.03 camt.998.001.02 or camt.998.001.03 camt.007.001.07 or camt.007.001.05 camt.998.001.02 or camt.998.001.03
Static Data Module (SD)	DeleteHAMAccount_SD ModifyLimit_SD ModifyReservation_SD DeleteRTGSAccount_SD DeleteSFAccount_SD DeleteSubAccount_SD ModifyHAMAccount_SD ModifyRTGSAccount_SD ModifySFAccount_SD ModifyStandingOrder_SD ModifyStandingOrderMirror_SD ModifySubAccount_SD ModifyStandingOrderDCA_SD	camt.998.001.02 or camt.998.001.03 camt.011.001.06 or camt.011.001.05 camt.048.001.04 or camt.048.001.03 camt.998.001.02 or camt.998.001.03 camt.998.001.02 or camt.998.001.03 camt.998.001.02 or camt.998.001.03 camt.998.001.02 or camt.998.001.03 camt.998.001.02 or camt.998.001.03 camt.998.001.02 or camt.998.001.03 camt.024.001.05 or camt.024.001.04 camt.998.001.02 or camt.998.001.03 camt.998.001.02 or camt.998.001.03
Ancillary System Interface (ASI)	ASInitiationStatus ASTransferInitiation ASTransferNotice ReturnGeneralBusinessInformation_AS SBTransferInitiation_AS	pain.998.001.01 pain.998.001.01 pain.998.001.01 camt.021.001.05 or camt.021.001.03 pain.998.001.01
Home Accounting Module (HAM)	CancelTransaction_HAM LiquidityCreditTransfer_HAM ModifyReservation_HAM	camt.008.001.07 or camt.008.001.05 camt.050.001.04 or camt.050.001.03 camt.048.001.04 or camt.048.001.03

²⁰ depends on the supported CAMT version

XML message related to ...	Request ²⁰	
	ModifyStandingOrder_HAM ModifyTransaction_HAM ReleasePayment_HAM	camt.024.001.05 or camt.024.001.04 camt.007.001.07 or camt.007.001.05 camt.998.001.02 or camt.998.001.03
Standing Facilities Module (SF)	LiquidityCreditTransfer_SF	camt.050.001.04 or camt.050.001.03
Reserve Management Module (RM)	AuthorizePenalty_RM InsertCompulsoryReserve_RM InsertPHABalance_RM	camt.998.001.02 or camt.998.001.03 camt.998.001.02 or camt.998.001.03 camt.998.001.02 or camt.998.001.03
Contingency Module	LiquidityCreditTransfer_CM	camt.050.001.04 or camt.050.001.03
Proprietary Home Account (PHA)	LiquidityCreditTransfer_PHA ModifyStandingOrder_PHA	camt.050.001.04 or camt.050.001.03 camt.024.001.05 or camt.024.001.04
T2S Interface (T2SI)	CancelTransaction_T2SI LiquidityCreditTransfer_T2SI	camt.008.001.07 camt.050.001.04

4.4 Request Header

This block is mandatory by SWIFT. It contains the following information:

- Distinguished Name of the Requestor (Requestor DN)
- Distinguished Name of the Responder (Responder DN)
- Service Name
- Request Type (*recommended by TARGET2*)
- Priority (*not used by TARGET2*)
- Request Reference

4.4.1 Requestor DN

The 'Requestor DN' identifies the sending party (= institution that sends the XML message).

The 'Requestor DN' is a X.500 distinguished name, ending with

o=<SWIFTNet institution BIC-8>,o=swift

No registration in the SWIFTNet directory tree of the sending party or certification of this DN is required. SWIFT recommends to use DN without too much nesting levels.

<SwInt:Requestor>,o=BIC-8,o=swift</SwInt:Requestor>

The value of the requestor field may be equal to the 'user DN' which is used to sign the message, but this is not mandatory.

4.4.2 Responder DN

The 'Responder DN' identifies the receiving party (= institution that receives the XML message and will reply on it). The 'Responder DN' is a X.500 distinguished name, ending with

o=<SWIFTNet institution BIC-8>,o=swift

For TARGET2 the 'Responder DN' to be used in the XML requests sent are the following:

- Customer test environment for INTERACT
<SwInt:Responder>cn=interact,ou=tet,o=trgtxepm,o=swift
</SwInt:Responder>
- Customer test environment for FILEACT
<SwInt:Responder>cn=fileact,ou=tet,o=trgtxepm,o=swift
</SwInt:Responder>
- Live environment for INTERACT
<SwInt:Responder>cn=interact,ou=prod,o=trgtxepm,o=swift
</SwInt:Responder>
- Arial environment for FILEACT
<SwInt:Responder>cn=fileact,ou=prod,o=trgtxepm,o=swift
</SwInt:Responder>

4.4.3 Service Name

The Service Name contains the SWIFTNet service used. For TARGET2 there are different Service Names in place for

- Customer test environment

Service Name	SWIFTNet service	Mode	Comment
trgt.papss!p	InterAct FileAct Browse	Real-time	-
trgt.sfpapss!p	InterAct	Store & forward	-

	FileAct		
trgt.cm!p	InterAct Browse	Real-time	For CBs only

- Live environment

Service Name	SWIFTNet service	Mode	Comment
trgt.papss	InterAct FileAct Browse	Real-time	-
trgt.sfpapss	InterAct FileAct	Store & forward	-
trgt.cm	InterAct Browse	Real-time	For CBs only

Note: The 'mode' determines which APIs/primitives developers will have to use to exchange XML messages.

The tag containing the Service Name is called <SwInt:Service>.

4.4.4 Request Type

The 'Request Type' identifies the message type of the XML message using the standard code for of the message (not a textual description). The use of this tag is optionally (in InterAct) but recommended by TARGET2.

The tag containing the 'Request Type' is called <SwInt:RequestType>

The following list contains all requests used by TARGET2 having a unique Request Type. All other messages (so called TARGET2 proprietary messages) will use the "container message" for free format messages provided by SWIFT (camt.998.001.xx).

Name	Request Type ²¹	Business Area
BackupPayment	camt.023.001.06 camt.023.001.04	cash management
CancelTransaction	camt.008.001.07 camt.008.001.05	cash management

²¹ depends on the supported CAMT version.

Name	Request Type²¹	Business Area
DeleteLimit	camt.012.001.06 camt.012.001.05	cash management
GetAccount	camt.003.001.06 camt.003.001.05	cash management
GetBusinessDayInformation	camt.018.001.04 camt.018.001.03	cash management
GetLimit	camt.009.001.06 camt.009.001.05	cash management
GetTransaction	camt.005.001.07 camt.005.001.05	cash management
LiquidityCreditTransfer	camt.050.001.04 camt.050.001.03	cash management
ModifyLimit	camt.011.001.06 camt.011.001.05	cash management
ModifyStandingOrder	camt.024.001.05 camt.024.001.04	cash management
ModifyTransaction	camt.007.001.07 camt.007.001.05	cash management
ReturnAccount (if pushed in SF)	camt.004.001.07 camt.004.001.05	cash management
GetReservation	camt.046.001.04 camt.046.001.03	cash management
ModifyReservation	camt.048.001.04 camt.048.001.03	cash management
DeleteReservation	camt.049.001.04 camt.049.001.03	cash management
SSPProprietaryMessage	camt.998.001.02 camt.998.001.03	cash management
STPCreditTransferInitiation	pain.998.001.01	payment initiation
PaymentInitiationStatus	pain.998.001.01	payment initiation
ASTransferNotice	pain.998.001.01	payment initiation
Receipt_AS	camt.025.001.04 camt.025.001.03	cash management
BillingReport_CRSS	camt.077.001.01	cash management

4.5 Payload

The blocks belonging to the Payload (Application header and the document of the XML message itself) are described in chapter 6.

Note: The application header and the document of the XML message are separated as shown in the extract of the GetLimit request:

```
...
<AppHdr xmlns="urn:swift:xsd:ahV10">
  ...
</AppHdr>
<Document xmlns="urn:swift:xsd:camt.009.001.04">
  <GetLmt>
    ...
  </GetLmt>
</Document>
...
```

It is the same for responses.

4.6 Cryptographic Blocks

This block is in general optional by SWIFT but mandatory when NRE is applied. There are no specific rules defined for this block by TARGET2.

4.7 Message Signature

This block is not relevant for TARGET2. It might be used according to the rules defined by SWIFT.

5 “Work as” and “act on behalf” scenario

5.1 Definition

The following definitions have to be taken into account when reading this chapter:

- The DN identifies the requestor, i.e. the participant’s application in A2A mode.
- The relation “work as” identifies the BIC(s) that are linked to the DN. In other words it identifies all participants (identified by a BIC) on which the DN has the possibility to perform actions. The relation is stored in the Static Data module in a so called DN-BIC table. *Note: When speaking of a DN-suffix (see sample below) in this context it is only the DN without CN (= common name).*
- The relation “act on behalf” identifies the BIC(s) that are linked to one BIC and corresponds to the situation when an account holder has the possibility to perform actions on accounts of other account holders (i.e. Co-Manager, GoA Manager, responsible CB). These relations are stored in the Static Data module in a so called BIC-BIC table.

Sample “User DN” and the corresponding “DN-suffix”:

User DN:	DN-suffix:
cn=josef,o=bankbebb,o=swift	o=bankbebb,o=swift
cn=app,ou=businessunit1,o=bankbebb,o=swift	ou=businessunit1,o=bankbebb,o=swift
ou=businessunit2,o=bankbebb,o=swift	ou=businessunit2,o=bankbebb,o=swift

5.2 Important information: One DN linked to several BIC11s (A2A)

There are differences in the implementation of messages processed via ICM and those processed via T2SI.

T2SI uses an extended application header where the “works as” BIC is included. Indication of this BIC will be mandatory if the requestor’s DN is linked to several BICs. Only the “acts on behalf” relation is taken from the Document part of the message.

ICM uses a simpler header where no customer BIC is included. Therefore, the management of “works as” relation with one DN matching to several BICs will be possible if the Document provides an indication of customer BIC or account ID, but in this case no “acts on behalf” relation is supported for the BICs covered by the “works as” relation.

There are some messages where the "works as scenario" in ICM-A2A is not possible because the XML messages do not contain a field to give the indication needed. As stated above, in case of two DN-BIC's in the matching table ICM would return error code 'X46' = 'No access. There is more than one BIC assigned to the DN' as response to these messages.

Messages where the “works as” scenario via ICM-A2A is not possible:

BackupPayment (for CI Customer)

GetBroadcast

GetCalendar

GetLegalEntity

GetSystemTime

GetPendingData

CancelTransaction

GetBusinessDayInformation

GetSettlementInformation

GetTransaction_PM

Modify Creditline (“work as” selection possible, but not meaningful)

ModifyTransaction

ReleasePayment

GetThreshold

Get CompulsoryReserve

5.3 Example

The definitions given in chapter 5.1 should be explained by the following examples.

Table DN-BIC reflecting the “work as scenario”

Institution	DN	BIC
CB1	DN-suffix01 ²²	BITAITR0XXX
CB2	DN-suffix02	MARKDEFFXXX
CB2	DN-suffix02	MARKDEMURXXX
CI1	DN-suffix03	BROMITRRXXX
CI2	DN-suffix04	DRESDEFFXXX
CI3	DN-suffix05	DEUTDEBE123

Table “acts on behalf” reflecting the “act on behalf scenario”

Type of relation	“Master” BIC	“Submitted” BIC
“CB responsible for”	BIC of the related CB	BICs of the participants of the CB
“co-management”	BIC of the co-manager	BICs of the co-managed accounts
“group of accounts”	BIC of the manager of the group of accounts	BICs of the accounts included in the group of accounts

In the example, only a “CB responsible for” relation with the following values is considered:

Type of relation	“Master” BIC	“Submitted” BIC
“CB responsible for”	BITAITR0XXX	BROMITRRXXX
“CB responsible for”	MARKDEFFXXX	DRESDEFFXXX
“CB responsible for”	MARKDEFFXXX	DEUTDEBE123

The relations between the DN-suffix and the BIC through “work as” and “act on behalf of” scenarios are presented in the scheme below. In addition, it is necessary to highlight that the various relations covered by “act on behalf” correspond to distinct functions applied to distinct set of BICs. For example, the set of BICs attached to one BIC in the frame of a “group of account manager” relation can be different from the one attached to the same BIC in the frame of a “co-manager” relation. The example below is only related to “CB responsible for” relation.

²² DN-suffix = DN without common name (CN)

Relations between DN-suffix and BIC through “work as” and “act on behalf of” scenarios:

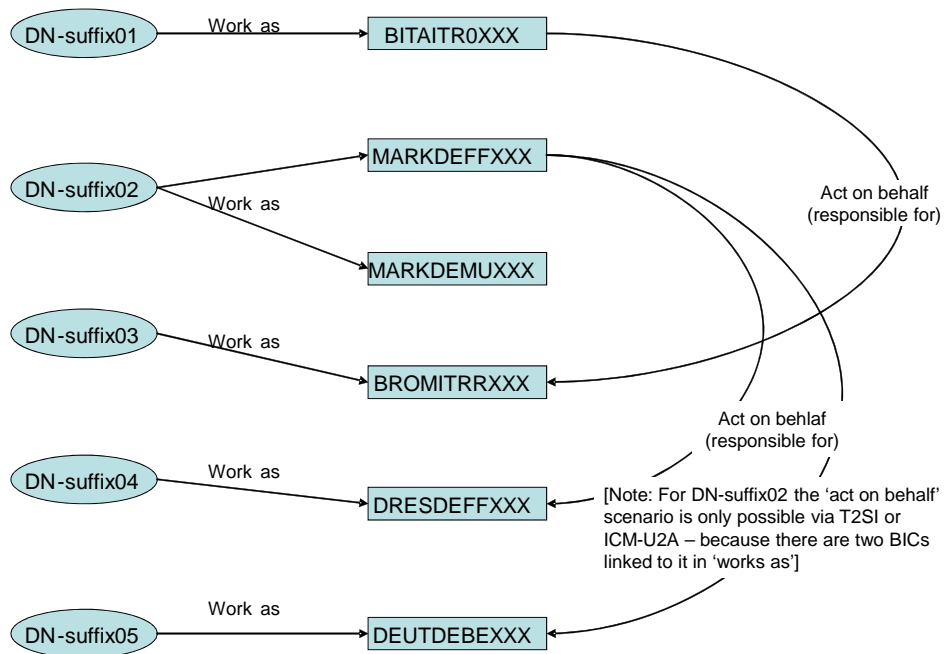

5.4 Implementation in A2A

The application of the participant (= requestor identified by its DN) has to mention the BIC on which it wants to perform actions (whatever the “work as” or “act on behalf”) in the XML message it sends. TARGET2 will check that the DN has the authorisation to perform the action using the following algorithm²³:

1st step Is the relation DN-suffix – BIC mentioned in the XML message listed in the “work as” table?

- ⇒ If yes the algorithm will be finished
- ⇒ If no 2nd step will be performed

2nd step Has the DN-suffix more than one ‘works as’ BICs?

- ⇒ If yes no ‘act on behalf’ scenario will be allowed (except for T2SI).
- ⇒ If no the 3rd step will be performed.

²³ The RBAC roles have to be checked before.

- 3rd step Is the relation between the BIC deducted out of the “work as” table and the BIC mentioned in the XML message listed in the “act on behalf” table?
- ⇒ If yes the algorithm will be finished.
 - ⇒ If no neither “work as” nor “act on behalf” is allowed.

5.5 Examples

The following examples should illustrate the implementation in A2A in addition to the general description given in chapter 5.3.

EXAMPLE 1:

The CB sends an XML message. TARGET2 takes the DN-suffix and the BIC out of the XML message (DN-suffix01 and BITAITR0XXX). (BDI: For all examples it is true that the DN-suffix is taken out from the XML message header but the BIC is taken out from the XML message payload):

Only the step 1 of the algorithm is performed → OK

DN-suffix01 is allowed to ‘work as’ BITAITR0XXX.

EXAMPLE 2:

The CB sends an XML message. TARGET2 takes the DN-suffix and the BIC out of the XML message (DN-suffix02 and MARKDEFFXXX):

Only the step 1 of the algorithm is performed → OK

DN-suffix02 is allowed to ‘work as’ MARKDEFFXXX.

EXAMPLE 3:

The CB sends an XML message. TARGET2 takes the DN and the BIC out of the XML message (DN-suffix02 and MARKDEMUMXXX):

Only the step 1 of the algorithm is performed → OK

DN-suffix02 is allowed to 'work as' MARKDEMUXXX.

EXAMPLE 4:

The CB sends an XML message. TARGET2 takes the DN and the BIC out of the XML message (DN-suffix02 and DRESDEFFXXX):

The step 1 of the algorithm is first performed → Not OK

The step 2 of the algorithm is performed → OK

DN-suffix02 is NOT allowed to work on behalf of DRESDEFFXXX.

EXAMPLE 5:

The CB sends an XML message. TARGET2 takes the DN and the BIC out of the XML message (DN-suffix01 and BROMITRRXXX):

The step 1 of the algorithm is first performed → Not OK

The step 2 of the algorithm is then performed → Not OK

The step 3 of the algorithm is then performed → OK

=> DN-suffix01 is allowed to 'act on behalf' of BROMITRRXXX.

6 Description of the Payload

Please note that Application header and document of the XML message are separated by

<Document>

(see chapter 4.5). The tags <Document> and </Document> are part of the payload.

6.1 How to read chapter 6

The detailed description of the Payload begins with the description of the Application header (chapter 6.2) and the common XML documents (chapter 6.3). Then it continues with the definition of specific XML documents used by each module (chapter 6.4 up to chapter 6.13).

For each XML message it is indicated whether the message:

- belongs to the Cash Management Standard/Payment Initiation or
- is a SSP Proprietary Message.

Note: When indicating that a message belongs to the Cash Management Standard it refers to version 2017 and 2012 (5.0) of the standard, except of camt.077 BillingReport which is candidate for ISO registration but not yet passed to a SWIFT Standards release.

To be able to clearly identify a single description and the related examples the following naming convention was chosen:

<name of XML message>[_<module>][_ <number of the example>]

Example: GetAccount_PM = definition of the XML message used by PM

GetAccount

GetAccount_PM_1 = first example related to the XML message

GetAccount_PM

For the different modules the following abbreviations are used:

ASI = Ancillary System Interface
CM = Contingency Module
CRSS = Customer Related Services System
HAM = Home Accounting Module
PHA = Proprietary Home Accounting System
PM = Payments Module
RM = Reserve Management Module
SD = Static Data
SF = Standing Facilities Module
T2SI = TARGET2 Securities Interface
TIPSI = TIPS Interface
no abbreviation = common XML messages

6. 2 Application Header

6. 2. 1 ApplicationHeader ASI

Cash Management Standard

ApplicationHeader_ASI

Scope: The ApplicationHeader is sent by both the customer client application and by the SSP server together with each message. For incoming messages, the ApplicationHeader must be used to address a message to a certain SSP module. For outgoing messages, the ApplicationHeader reports the module the message is coming from.

Usage
Related module:all

The message contains the following information:
Receiving or emitting module
Date and time when the message is issued.

Technical Examples

A message should be addressed to a certain module. To route the message to the module, the Application Header takes the short name of the addressed module.

- the module name ICM can be used in Receipt messages returned by SSP in case of a severe error. E.g. when no ApplicationHeader was sent in the request and a module can not be evaluated.

Structure:

ApplicationHeader	<AppHdr>
InitiatingEntityIdentification	<From>
Type	<Type>NAME</Type>
Entity Identifier	<Id>ASI</Id>
End of InitiatingEntityIdentification	</From>
ReceivingEntityIdentification	<To>
Type	<Type>NAME</Type>
Message business identification	<Id>ASI</Id>
End of ReceivingEntityIdentification	</To>
MessageReference	<MsgRef></MsgRef>
CreationDateTime	<CrDate></CrDate>
End of ApplicationHeader	</AppHdr>

Attributes:

name of attribute	format	short description	description
<AppHdr>		ApplicationHeader	ApplicationHeader
		Mandatory	Validation:
<From>		InitiatingEntityIdentification	The entity being the business responsible for submitting this message. The type of identification must be determined when defining the Standards.
		Optional	Validation: [0..1]
<Type>-</Type>	4x	Type	The type of identifier. This can be the URI of the registrar of the names.
		Mandatory	Validation: [1..1] always "NAME"
<Id>-</Id>	30x	Entity Identifier	The actual identification of the entity
		Mandatory	Validation: [1..1] only ASI (Ancillary System Interface) is possible
</From>		End of InitiatingEntityIdentification	
		Optional	Validation: [0..1]
<To>		ReceivingEntityIdentification	The entity that the "From" business entity has chosen to be the business receiver of the message. The type of identification must be determined when defining the Standards.
		Optional	Validation: [0..1]
<Type>-</Type>	4x	Type	The type of identifier. This can be the URI of the registrar of the names.
		Mandatory	Validation: [1..1] always "NAME"
<Id>-</Id>	35x	Message business identification	
		Mandatory	Validation: [1..1] only ASI (Ancillary System Interface) is possible
</To>		End of ReceivingEntityIdentification	
		Optional	Validation: [0..1]
<MsgRef>-</MsgRef>	30x	MessageReference	It uniquely identifies a Message from a business application standpoint. It must be unique between a "From" and a "To".
		Mandatory	Validation: [1..1] not used in SSP
<CrDate>-</CrDate>	ISODateTime	CreationDateTime	Time when the message was created. This is the time the "From" claims to have created the message.
		Mandatory	Validation: [1..1] creation date - time when the message was created

name of attribute	format	short description	description
</AppHdr>		End of ApplicationHeader	end of ApplicationHeader
		Mandatory	Validation:

Error Codes:

ApplicationHeader_ASI_1

Scope: Message from ASI

ApplicationHeader	<AppHdr>
InitiatingEntityIdentification	<From>
Type	<Type>NAME</Type>
Entity Identifier	<Id>ASI</Id>
End of InitiatingEntityIdentification	</From>
MessageReference	<MsgRef>void</MsgRef>
CreationDateTime	<CrDate>2007-01-01T12:00:00</CrDate>
End of ApplicationHeader	</AppHdr>

ApplicationHeader_ASI_2

Scope: Message to ASI

ApplicationHeader	<AppHdr>
ReceivingEntityIdentification	<To>
Type	<Type>NAME</Type>
Message business identification	<Id>ASI</Id>
End of ReceivingEntityIdentification	</To>
MessageReference	<MsgRef>void</MsgRef>
CreationDateTime	<CrDate>2007-01-01T12:00:00</CrDate>
End of ApplicationHeader	</AppHdr>

6. 2. 2 ApplicationHeader CM (for CBs only)

Cash Management Standard

ApplicationHeader_CM

Scope: The ApplicationHeader is sent by both the customer client application and by the SSP server together with each message. For incoming messages, the ApplicationHeader must be used to address a message to a certain SSP module. For outgoing messages, the ApplicationHeader reports the module the message is coming from.

Usage

Related module: CM

The message contains the following information:

Receiving or emitting module

Date and time when the message is issued.

Technical Examples

A message should be addressed to a certain module. To route the message to the module, the Application Header takes the short name of the addressed module.

- the module name ICM can be used in Receipt messages returned by SSP in case of a severe error. E.g. when no ApplicationHeader was sent in the request and a module can not be evaluated.

Structure:

ApplicationHeader	<AppHdr>
InitiatingEntityIdentification	<From>
Type	<Type>NAME</Type>
Entity Identifier	<Id>CM</Id>
End of InitiatingEntityIdentification	</From>
ReceivingEntityIdentification	<To>
Type	<Type>NAME</Type>
Entity Identifier	<Id>CM</Id>
End of ReceivingEntityIdentification	</To>
MessageReference	<MsgRef></MsgRef>
CreationDateTime	<CrDate></CrDate>
End of ApplicationHeader	</AppHdr>

Attributes:

name of attribute	format	short description	description
<AppHdr>		ApplicationHeader	ApplicationHeader
		Mandatory	Validation:
		A2A	[1..1]
<From>		InitiatingEntityIdentification	The entity being the business responsible for submitting this message. The type of identification must be determined when defining the Standards.
		Optional	Validation:
		A2A	[0..1] source - used for Return and Receipt messages only
<Type>-</Type>	4x	Type	The type of identifier. This can be the URI of the registrar of the names.
		Mandatory	Validation:
		A2A	[1..1] only NAME is possible
<Id>-</Id>	30x	Entity Identifier	The actual identification of the entity
		Mandatory	Validation:
		A2A	[1..1] It must be "CM" (Contingency Module)
</From>		End of InitiatingEntityIdentification	
		Optional	Validation:
		A2A	[0..1]
<To>		ReceivingEntityIdentification	The entity that the "From" business entity has chosen to be the business receiver of the message. The type of identification must be determined when defining the Standards.
		Optional	Validation:
		A2A	[0..1] destination - used for Get, LiquidityCreditTransfer, etc. messages only
<Type>-</Type>	4x	Type	The type of identifier. This can be the URI of the registrar of the names.
		Mandatory	Validation:
		A2A	[1..1] only NAME is possible
<Id>-</Id>	30x	Entity Identifier	The actual identification of the entity
		Mandatory	Validation:
		A2A	[1..1] It must be "CM" (Contingency Module)
</To>		End of ReceivingEntityIdentification	
		Optional	Validation:
		A2A	[0..1]
<MsgRef>-</MsgRef>	30x	MessageReference	It uniquely identifies a Message from a business application standpoint. It must be unique between a "From" and a "To".
		Mandatory	Validation:
		A2A	[1..1] Not used in SSP.
<CrDate>-</CrDate>	ISODateTime	CreationDateTime	Time when the message was created. This is the time the "From" claims to have created the message.

name of attribute	format	short description	description
		Mandatory A2A	Validation: [1..1] Time when the message was created
</AppHdr>		End of ApplicationHeader	end of ApplicationHeader
		Mandatory A2A	Validation: [1..1]

Error Codes:

ApplicationHeader_CM_1

Scope: Message to CM

ApplicationHeader	<AppHdr>
ReceivingEntityIdentification	<To>
Type	<Type>NAME</Type>
Entity Identifier	<Id>CM</Id>
End of ReceivingEntityIdentification	</To>
MessageReference	<MsgRef>void</MsgRef>
CreationDateTime	<CrDate>2007-01-01T12:00:00</CrDate>
End of ApplicationHeader	</AppHdr>

ApplicationHeader_CM_2

Scope: Message from CM

ApplicationHeader	<AppHdr>
InitiatingEntityIdentification	<From>
Type	<Type>NAME</Type>
Entity Identifier	<Id>CM</Id>
End of InitiatingEntityIdentification	</From>
MessageReference	<MsgRef>void</MsgRef>
CreationDateTime	<CrDate>2007-01-01T12:00:00</CrDate>
End of ApplicationHeader	</AppHdr>

6. 2. 3 ApplicationHeader HAM

Cash Management Standard

ApplicationHeader_HAM

Scope: The ApplicationHeader is send by both the customer client application and by the SSP server together with each message. For incoming messages, the ApplicationHeader must be used to address a message to a certain SSP module. For outgoing messages, the ApplicationHeader reports the module the message is coming from.

Usage
Related module:all

The message contains the following information:
Receiving or emitting module
Date and time when the message is issued.

Technical Examples

A message should be addressed to a certain module. To route the message to the module, the Application Header takes the short name of the addressed module.

- the module name ICM can be used in Receipt messages returned by SSP in case of a severe error. E.g. when no ApplicationHeader was sent in the request and a module can not be evaluated.

Structure:

ApplicationHeader	<AppHdr>
InitiatingEntityIdentification	<From>
Type	<Type>NAME</Type>
Entity Identifier	<Id>HAM</Id>
End of InitiatingEntityIdentification	</From>
ReceivingEntityIdentification	<To>
Type	<Type>NAME</Type>
Entity Identifier	<Id>HAM</Id>
End of ReceivingEntityIdentification	</To>
MessageReference	<MsgRef></MsgRef>
CreationDateTime	<CrDate></CrDate>
End of ApplicationHeader	</AppHdr>

Attributes:

name of attribute	format	short description	description
<AppHdr>		ApplicationHeader	ApplicationHeader
		Mandatory A2A	Validation:
<From>		InitiatingEntityIdentification	The entity being the business responsible for submitting this message. The type of identification must be determined when defining the Standards.
		Optional A2A	Validation: [0..1] source - used for Return and Receipt messages only
<Type>-</Type>	4x	Type	The type of identifier. This can be the URI of the registrar of the names.
		Mandatory A2A	Validation: [1..1] only NAME is possible
<Id>-</Id>	30x	Entity Identifier	The actual identification of the entity
		Mandatory A2A	Validation: [1..1] In SSP only HAM (Home Accounting Module) and ICM (Information and Control Module - used for technical protocol messages send by SSP and not linked to the module) is possible
</From>		End of InitiatingEntityIdentification	
		Optional A2A	Validation: [0..1]
<To>		ReceivingEntityIdentification	The entity that the "From" business entity has chosen to be the business receiver of the message. The type of identification must be determined when defining the Standards.
		Optional A2A	Validation: [0..1] destination - used for Get, Modify, Cancel etc messages only
<Type>-</Type>	4x	Type	The type of identifier. This can be the URI of the registrar of the names.
		Mandatory A2A	Validation: [1..1] only NAME is possible
<Id>-</Id>	30x	Entity Identifier	The actual identification of the entity
		Mandatory A2A	Validation: [1..1] In SSP only HAM (Home Accounting Module) is possible
</To>		End of ReceivingEntityIdentification	
		Optional A2A	Validation: [0..1]
<MsgRef>-</MsgRef>	30x	MessageReference	It uniquely identifies a Message from a business application standpoint. It must be unique between a "From" and a "To".
		Mandatory	Validation:

name of attribute	format	short description	description
		A2A	[1..1] Not used in SSP
<CrDate>-</CrDate>	ISODateTime	CreationDateTime	Time when the message was created. This is the time the "From" claims to have created the message.
		Mandatory	Validation:
		A2A	[1..1] Time when the message was created
</AppHdr>		End of ApplicationHeader	end of ApplicationHeader
		Mandatory	Validation:
		A2A	

Error Codes:

ApplicationHeader_HAM_1

Scope: Message to HAM

ApplicationHeader	<AppHdr>
ReceivingEntityIdentification	<To>
Type	<Type>NAME</Type>
Entity Identifier	<Id>HAM</Id>
End of ReceivingEntityIdentification	</To>
MessageReference	<MsgRef>void</MsgRef>
CreationDateTime	<CrDate>2007-01-01T12:00:00</CrDate>
End of ApplicationHeader	</AppHdr>

ApplicationHeader_HAM_2

Scope: Message from HAM

ApplicationHeader	<AppHdr>
InitiatingEntityIdentification	<From>
Type	<Type>NAME</Type>
Entity Identifier	<Id>HAM</Id>
End of InitiatingEntityIdentification	</From>
MessageReference	<MsgRef>void</MsgRef>
CreationDateTime	<CrDate>2007-01-01T12:00:00</CrDate>
End of ApplicationHeader	</AppHdr>

6. 2. 4 ApplicationHeader PM

Cash Management Standard

ApplicationHeader_PM

Scope: The ApplicationHeader is send by both the customer client application and by the SSP server together with each message. For incoming messages, the ApplicationHeader must be used to address a message to a certain SSP module. For outgoing messages, the ApplicationHeader reports the module the message is coming from.

Usage
Related module:all

The message contains the following information:
Receiving or emitting module
Date and time when the message is issued.

Technical Examples
A message should be addressed to a certain module. To route the message to the module, the Application Header takes the short name of the addressed module.

- the module name ICM can be used in Receipt messages returned by SSP in case of a severe error. E.g. when no ApplicationHeader was sent in the request and a module can not be evaluated.

Structure:

ApplicationHeader	<AppHdr>
InitiatingEntityIdentification	<From>
Type	<Type>NAME</Type>
Entity Identifier	<Id>PM</Id>
End of InitiatingEntityIdentification	</From>
ReceivingEntityIdentification	<To>
Type	<Type>NAME</Type>
Entity Identifier	<Id>PM</Id>
End of ReceivingEntityIdentification	</To>
MessageReference	<MsgRef></MsgRef>
CreationDateTime	<CrDate></CrDate>
End of ApplicationHeader	</AppHdr>

Attributes:

name of attribute	format	short description	description
<AppHdr>		ApplicationHeader	ApplicationHeader
		Mandatory A2A	Validation:
<From>		InitiatingEntityIdentification	The entity being the business responsible for submitting this message. The type of identification must be determined when defining the Standards.
		Optional A2A	Validation: [0..1] source - used for Return and Receipt messages only
<Type>-</Type>	4x	Type	The type of identifier. This can be the URI of the registrar of the names.
		Mandatory A2A	Validation: [1..1] only NAME is possible
<Id>-</Id>	30x	Entity Identifier	The actual identification of the entity
		Mandatory A2A	Validation: [1..1] only PM and ICM (Information and Control Module - used for technical protocol messages send by SSP and not linked to the module) is possible
</From>		End of InitiatingEntityIdentification	
		Optional A2A	Validation: [0..1]
<To>		ReceivingEntityIdentification	The entity that the "From" business entity has chosen to be the business receiver of the message. The type of identification must be determined when defining the Standards.
		Optional A2A	Validation: [0..1] destination - used for Get, Modify, Cancel etc messages only
<Type>-</Type>	4x	Type	The type of identifier. This can be the URI of the registrar of the names.
		Mandatory A2A	Validation: [1..1] only NAME is possible
<Id>-</Id>	30x	Entity Identifier	The actual identification of the entity
		Mandatory A2A	Validation: [1..1] only PM (Payment Module) is possible
</To>		End of ReceivingEntityIdentification	
		Optional A2A	Validation: [0..1]
<MsgRef>-</MsgRef>	30x	MessageReference	It uniquely identifies a Message from a business application standpoint. It must be unique between a "From" and a "To".
		Mandatory A2A	Validation: [1..1] Not used in SSP

name of attribute	format	short description	description
<CrDate>-</CrDate>	ISODateTime	CreationDateTime	Time when the message was created. This is the time the "From" claims to have created the message.
		Mandatory	Validation:
		A2A	[1..1] Time when the message was created
</AppHdr>		End of ApplicationHeader	end of ApplicationHeader
		Mandatory	Validation:
		A2A	

Error Codes:

ApplicationHeader_PM_1

Scope: Message to PM

ApplicationHeader	<AppHdr>
ReceivingEntityIdentification	<To>
Type	<Type>NAME</Type>
Entity Identifier	<Id>PM</Id>
End of ReceivingEntityIdentification	</To>
MessageReference	<MsgRef>void</MsgRef>
CreationDateTime	<CrDate>2007-01-01T12:00:00</CrDate>
End of ApplicationHeader	</AppHdr>

ApplicationHeader_PM_2

Scope: Message from PM

ApplicationHeader	<AppHdr>
InitiatingEntityIdentification	<From>
Type	<Type>NAME</Type>
Entity Identifier	<Id>PM</Id>
End of InitiatingEntityIdentification	</From>
MessageReference	<MsgRef>void</MsgRef>
CreationDateTime	<CrDate>2007-01-01T12:00:00</CrDate>
End of ApplicationHeader	</AppHdr>

6. 2. 5 ApplicationHeader RMM

Cash Management Standard

ApplicationHeader_RMM

Scope: The ApplicationHeader is send by both the customer client application and by the SSP server together with each message. For incoming messages, the ApplicationHeader must be used to address a message to a certain SSP module. For outgoing messages, the ApplicationHeader reports the module the message is coming from.

Usage
Related module:all

The message contains the following information:
Receiving or emitting module
Date and time when the message is issued.

Technical Examples

A message should be addressed to a certain module. To route the message to the module, the Application Header takes the short name of the addressed module.

- the module name ICM can be used in Receipt messages returned by SSP in case of a severe error. E.g. when no ApplicationHeader was sent in the request and a module can not be evaluated.

Structure:

ApplicationHeader	<AppHdr>
InitiatingEntityIdentification	<From>
Type	<Type>NAME</Type>
Entity Identifier	<Id>RMM</Id>
End of InitiatingEntityIdentification	</From>
ReceivingEntityIdentification	<To>
Type	<Type>NAME</Type>
Entity Identifier	<Id>RMM</Id>
End of ReceivingEntityIdentification	</To>
MessageReference	<MsgRef></MsgRef>
CreationDateTime	<CrDate></CrDate>
End of ApplicationHeader	</AppHdr>

Attributes:

name of attribute	format	short description	description
<AppHdr>		ApplicationHeader	ApplicationHeader
		Mandatory A2A	Validation:
<From>		InitiatingEntityIdentification	The entity being the business responsible for submitting this message. The type of identification must be determined when defining the Standards.
		Optional A2A	Validation: [0..1] source - used for Return and Receipt messages only
<Type>-</Type>	4x	Type	The type of identifier. This can be the URI of the registrar of the names.
		Mandatory A2A	Validation: [1..1] only NAME is possible
<Id>-</Id>	30x	Entity Identifier	The actual identification of the entity
		Mandatory A2A	Validation: [1..1] only RMM (Reserve Management Module) and ICM (Information and Control Module - used for technical protocol messages send by SSP and not linked to the module) is possible
</From>		End of InitiatingEntityIdentification	
		Optional A2A	Validation: [0..1]
<To>		ReceivingEntityIdentification	The entity that the "From" business entity has chosen to be the business receiver of the message. The type of identification must be determined when defining the Standards.
		Optional A2A	Validation: [0..1] destination - used for Get, Modify, Cancel etc messages only
<Type>-</Type>	4x	Type	The type of identifier. This can be the URI of the registrar of the names.
		Mandatory A2A	Validation: [1..1] only NAME is possible
<Id>-</Id>	30x	Entity Identifier	The actual identification of the entity
		Mandatory A2A	Validation: [1..1] only RMM (Reserve Management Module) is possible
</To>		End of ReceivingEntityIdentification	
		Optional A2A	Validation: [0..1]
<MsgRef>-</MsgRef>	30x	MessageReference	It uniquely identifies a Message from a business application standpoint. It must be unique between a "From" and a "To".
		Mandatory	Validation:

name of attribute	format	short description	description
		A2A	[1..1] Not used in SSP
<CrDate>-</CrDate>	ISODateTime	CreationDateTime	Time when the message was created. This is the time the "From" claims to have created the message.
		Mandatory	Validation:
		A2A	[1..1] Time when the message was created
</AppHdr>		End of ApplicationHeader	end of ApplicationHeader
		Mandatory	Validation:
		A2A	

Error Codes:

ApplicationHeader_RMM_1

Scope: Message to RMM

ApplicationHeader	<AppHdr>
ReceivingEntityIdentification	<To>
Type	<Type>NAME</Type>
Entity Identifier	<Id>RMM</Id>
End of ReceivingEntityIdentification	</To>
MessageReference	<MsgRef>void</MsgRef>
CreationDateTime	<CrDate>2007-01-01T12:00:00</CrDate>
End of ApplicationHeader	</AppHdr>

ApplicationHeader_RMM_2

Scope: Message from RMM

ApplicationHeader	<AppHdr>
InitiatingEntityIdentification	<From>
Type	<Type>NAME</Type>
Entity Identifier	<Id>RMM</Id>
End of InitiatingEntityIdentification	</From>
MessageReference	<MsgRef>void</MsgRef>
CreationDateTime	<CrDate>2007-01-01T12:00:00</CrDate>
End of ApplicationHeader	</AppHdr>

6. 2. 6 ApplicationHeader SDM

Cash Management Standard

ApplicationHeader_SDM

Scope: The ApplicationHeader is send by both the customer client application and by the SSP server together with each message. For incoming messages, the ApplicationHeader must be used to address a message to a certain SSP module. For outgoing messages, the ApplicationHeader reports the module the message is coming from.

Usage
Related module:all

The message contains the following information:
Receiving or emitting module
Date and time when the message is issued.

Technical Examples

A message should be addressed to a certain module. To route the message to the module, the Application Header takes the short name of the addressed module.

- the module name ICM can be used in Receipt messages returned by SSP in case of a severe error. E.g. when no ApplicationHeader was sent in the request and a module can not be evaluated.

Structure:

ApplicationHeader	<AppHdr>
InitiatingEntityIdentification	<From>
Type	<Type>NAME</Type>
Entity Identifier	<Id>SDM</Id>
End of InitiatingEntityIdentification	</From>
ReceivingEntityIdentification	<To>
Type	<Type>NAME</Type>
Entity Identifier	<Id>SDM</Id>
End of ReceivingEntityIdentification	</To>
MessageReference	<MsgRef></MsgRef>
CreationDateTime	<CrDate></CrDate>
End of ApplicationHeader	</AppHdr>

Attributes:

name of attribute	format	short description	description
<AppHdr>		ApplicationHeader	ApplicationHeader
		Mandatory A2A	Validation:
<From>		InitiatingEntityIdentification	The entity being the business responsible for submitting this message. The type of identification must be determined when defining the Standards.
		Optional A2A	Validation: [0..1] source - used for Return and Receipt messages only
<Type>-</Type>	4x	Type	The type of identifier. This can be the URI of the registrar of the names.
		Mandatory A2A	Validation: [1..1] only NAME is possible
<Id>-</Id>	30x	Entity Identifier	The actual identification of the entity
		Mandatory A2A	Validation: [1..1] only SDM (Static Data Module) and ICM (Information and Control Module - used for technical protocol messages send by SSP and not linked to the module) is possible
</From>		End of InitiatingEntityIdentification	
		Optional A2A	Validation: [1..1]
<To>		ReceivingEntityIdentification	The entity that the "From" business entity has chosen to be the business receiver of the message. The type of identification must be determined when defining the Standards.
		Optional A2A	Validation: [0..1] destination - used for Get, Modify, Cancel etc messages only
<Type>-</Type>	4x	Type	The type of identifier. This can be the URI of the registrar of the names.
		Mandatory A2A	Validation: [1..1] only NAME is possible
<Id>-</Id>	30x	Entity Identifier	The actual identification of the entity
		Mandatory A2A	Validation: [1..1] only SDM (Static Data Module) is possible
</To>		End of ReceivingEntityIdentification	
		Optional A2A	Validation: [0..1]
<MsgRef>-</MsgRef>	30x	MessageReference	It uniquely identifies a Message from a business application standpoint. It must be unique between a "From" and a "To".
		Mandatory A2A	Validation: [1..1] Not used in SSP

name of attribute	format	short description	description
<CrDate>-</CrDate>	ISODateTime	CreationDateTime	Time when the message was created. This is the time the "From" claims to have created the message.
		Mandatory	Validation:
		A2A	[1..1] Time when the message was created
</AppHdr>		End of ApplicationHeader	end of ApplicationHeader
		Mandatory	Validation:
		A2A	

Error Codes:

ApplicationHeader_SDM_1

Scope: Message to SDM

ApplicationHeader	<AppHdr>
ReceivingEntityIdentification	<To>
Type	<Type>NAME</Type>
Entity Identifier	<Id>SDM</Id>
End of ReceivingEntityIdentification	</To>
MessageReference	<MsgRef>void</MsgRef>
CreationDateTime	<CrDate>2007-01-01T12:00:00</CrDate>
End of ApplicationHeader	</AppHdr>

ApplicationHeader_SDM_2

Scope: Message from SDM

ApplicationHeader	<AppHdr>
InitiatingEntityIdentification	<From>
Type	<Type>NAME</Type>
Entity Identifier	<Id>SDM</Id>
End of InitiatingEntityIdentification	</From>
MessageReference	<MsgRef>void</MsgRef>
CreationDateTime	<CrDate>2007-01-01T12:00:00</CrDate>
End of ApplicationHeader	</AppHdr>

6. 2. 7 ApplicationHeader SFM

Cash Management Standard

ApplicationHeader_SFM

Scope: The ApplicationHeader is send by both the customer client application and by the SSP server together with each message. For incoming messages, the ApplicationHeader must be used to address a message to a certain SSP module. For outgoing messages, the ApplicationHeader reports the module the message is coming from.

Usage
Related module:all

The message contains the following information:
Receiving or emitting module
Date and time when the message is issued.

Technical Examples

A message should be addressed to a certain module. To route the message to the module, the Application Header takes the short name of the addressed module.

- the module name ICM can be used in Receipt messages returned by SSP in case of a severe error. E.g. when no ApplicationHeader was sent in the request and a module can not be evaluated.

Structure:

ApplicationHeader	<AppHdr>
InitiatingEntityIdentification	<From>
Type	<Type>NAME</Type>
Entity Identifier	<Id>SFM</Id>
End of InitiatingEntityIdentification	</From>
ReceivingEntityIdentification	<To>
Type	<Type>NAME</Type>
Entity Identifier	<Id>SFM</Id>
End of ReceivingEntityIdentification	</To>
MessageReference	<MsgRef></MsgRef>
CreationDateTime	<CrDate></CrDate>
End of ApplicationHeader	</AppHdr>

Attributes:

name of attribute	format	short description	description
<AppHdr>		ApplicationHeader	ApplicationHeader
		Mandatory A2A	Validation:
<From>		InitiatingEntityIdentification	The entity being the business responsible for submitting this message. The type of identification must be determined when defining the Standards.
		Optional A2A	Validation: [0..1] source - used for Return and Receipt messages only
<Type>-</Type>	4x	Type	The type of identifier. This can be the URI of the registrar of the names.
		Mandatory A2A	Validation: [1..1] only NAME is possible
<Id>-</Id>	30x	Entity Identifier	The actual identification of the entity
		Mandatory A2A	Validation: [1..1] only SFM (Standing Facilities Module) and ICM (Information and Control Module - used for technical protocol messages send by SSP and not linked to the module) is possible
</From>		End of InitiatingEntityIdentification	
		Optional A2A	Validation: [0..1]
<To>		ReceivingEntityIdentification	The entity that the "From" business entity has chosen to be the business receiver of the message. The type of identification must be determined when defining the Standards.
		Optional A2A	Validation: [0..1] destination - used for Get, Modify, Cancel etc messages only
<Type>-</Type>	4x	Type	The type of identifier. This can be the URI of the registrar of the names.
		Mandatory A2A	Validation: [1..1] only NAME is possible
<Id>-</Id>	30x	Entity Identifier	The actual identification of the entity
		Mandatory A2A	Validation: [1..1] only SFM (Standing Facilities Module) is possible
</To>		End of ReceivingEntityIdentification	
		Optional A2A	Validation: [0..1]
<MsgRef>-</MsgRef>	30x	MessageReference	It uniquely identifies a Message from a business application standpoint. It must be unique between a "From" and a "To".
		Mandatory A2A	Validation: [1..1] Not used in SSP

name of attribute	format	short description	description
<CrDate>-</CrDate>	ISODateTime	CreationDateTime	Time when the message was created. This is the time the "From" claims to have created the message.
		Mandatory	Validation:
		A2A	[1..1] Time when the message was created
</AppHdr>		End of ApplicationHeader	end of ApplicationHeader
		Mandatory	Validation:
		A2A	

Error Codes:

ApplicationHeader_SFM_1

Scope: Message to SFM

ApplicationHeader	<AppHdr>
ReceivingEntityIdentification	<To>
Type	<Type>NAME</Type>
Entity Identifier	<Id>SFM</Id>
End of ReceivingEntityIdentification	</To>
MessageReference	<MsgRef>void</MsgRef>
CreationDateTime	<CrDate>2007-01-01T12:00:00</CrDate>
End of ApplicationHeader	</AppHdr>

ApplicationHeader_SFM_2

Scope: Message from SFM

ApplicationHeader	<AppHdr>
InitiatingEntityIdentification	<From>
Type	<Type>NAME</Type>
Entity Identifier	<Id>SFM</Id>
End of InitiatingEntityIdentification	</From>
MessageReference	<MsgRef>void</MsgRef>
CreationDateTime	<CrDate>2007-01-01T12:00:00</CrDate>
End of ApplicationHeader	</AppHdr>

6. 2. 8 ApplicationHeaderPHAExtern

Cash Management Standard

ApplicationHeaderPHAExtern

Scope: Each incoming and outgoing message contains an Application Header. The Application Header serves to transmit information on how to process the functional document. Application Header for external usage. Mandatory for message exchange between user and SSP. It is created and used by either the initiating user (requests) or by SSP (responses).

- the module name ICM can be used in Receipt messages returned by SSP in case of a severe error. E.g. when no ApplicationHeader was sent in the request and a module can not be evaluated.

Structure:

ApplicationHeader	<AppHdr>
InitiatingEntityIdentification	<From>
Type	<Type>NAME</Type>
Entity Identifier	<Id>PHA</Id>
End of InitiatingEntityIdentification	</From>
ReceivingEntityIdentification	<To>
Type	<Type>NAME</Type>
Entity Identifier	<Id>PHA</Id>
End of ReceivingEntityIdentification	</To>
MessageReference	<MsgRef></MsgRef>
CreationDateTime	<CrDate></CrDate>
End of ApplicationHeader	</AppHdr>

Attributes:

name of attribute	format	short description	description
<AppHdr>		ApplicationHeader	ApplicationHeader
		Mandatory	Validation:
		A2A	ApplicationHeader for external usage. Mandatory for message exchange between user and SSP
<From>		InitiatingEntityIdentification	The entity being the business responsible for submitting this message. The type of identification must be determined when defining the Standards.
		Optional	Validation:
		A2A	[0..1] source - used for Return and Receipt messages only
<Type>-</Type>	4x	Type	The type of identifier. This can be the URI of the registrar of the names.
		Mandatory	Validation:
		A2A	[1..1] only NAME is possible
<Id>-</Id>	30x	Entity Identifier	The actual identification of the entity
		Mandatory	Validation:
		A2A	[1..1] only PHA is possible
</From>		End of InitiatingEntityIdentification	
		Optional	Validation:
		A2A	[0..1]
<To>		ReceivingEntityIdentification	The entity that the "From" business entity has chosen to be the business receiver of the message. The type of identification must be determined when defining the Standards.
		Optional	Validation:
		A2A	[0..1] destination - used for Get, Modify, Cancel etc messages only
<Type>-</Type>	4x	Type	The type of identifier. This can be the URI of the registrar of the names.
		Mandatory	Validation:
		A2A	[1..1] only NAME is possible
<Id>-</Id>	30x	Entity Identifier	The actual identification of the entity
		Mandatory	Validation:
		A2A	[1..1] only PHA is possible
</To>		End of ReceivingEntityIdentification	
		Optional	Validation:
		A2A	[0..1]
<MsgRef>-</MsgRef>	30x	MessageReference	It uniquely identifies a Message from a business application standpoint. It must be unique between a "From" and a "To".
		Mandatory	Validation:
		A2A	[1..1] Not used in SSP
<CrDate>-</CrDate>	ISODateTim	CreationDateTime	Time when the message was created. This is the time

name of attribute	format	short description	description
	e	Mandatory A2A	the "From" claims to have created the message. Validation: [1..1] Time when the message was created
</AppHdr>		End of ApplicationHeader Mandatory A2A	end of ApplicationHeader Validation:

Error Codes:

ApplicationHeaderPHAExtern_1

Scope: Sample for Get, Modify, Cancel etc. messages

ApplicationHeader	<AppHdr>
ReceivingEntityIdentification	<To>
Type	<Type>NAME</Type>
Entity Identifier	<Id>PHA</Id>
End of ReceivingEntityIdentification	</To>
MessageReference	<MsgRef>void</MsgRef>
CreationDateTime	<CrDate>2007-01-01T12:00:00</CrDate>
End of ApplicationHeader	</AppHdr>

ApplicationHeaderPHAExtern_2

Scope: Sample for Return and Receipt messages

ApplicationHeader	<AppHdr>
InitiatingEntityIdentification	<From>
Type	<Type>NAME</Type>
Entity Identifier	<Id>PHA</Id>
End of InitiatingEntityIdentification	</From>
MessageReference	<MsgRef>void</MsgRef>
CreationDateTime	<CrDate>2007-01-01T12:00:00</CrDate>
End of ApplicationHeader	</AppHdr>

6. 2. 9 ApplicationHeaderPHAIntern (for CBs only)

PHA internal usage

ApplicationHeaderPHAIntern

Scope: Each incoming and outgoing message contains an Application Header. The Application Header serves to transmit information on how to process the functional document. Application Header for internal usage. Mandatory for message exchange between ICM and PHA. It is created and used by either ICM (requests) or the PHA (responses).

- the module name ICM can be used in Receipt messages returned by SSP in case of a severe error. E.g. when no ApplicationHeader was sent in the request and a module can not be evaluated.

Structure:

ApplicationHeader	<AppHdr>
InitiatingEntityIdentification	<From>
Type	<Type>NAME</Type>
Entity Identifier	<Id>PHA</Id>
End of InitiatingEntityIdentification	</From>
ReceivingEntityIdentification	<To>
Type	<Type>NAME</Type>
Entity Identifier	<Id>PHA</Id>
End of ReceivingEntityIdentification	</To>
MessageName	<MsgName></MsgName>
MessageReference	<MsgRef></MsgRef>
CreationDateTime	<CrDate></CrDate>
Duplicate Indication	<Dup>
Duplicate Reference	<Ref></Ref>
Information	<Info></Info>
End duplicate indication	</Dup>
End of ApplicationHeader	</AppHdr>

Attributes:

name of attribute	format	short description	description
<AppHdr>		ApplicationHeader	ApplicationHeader
		Mandatory	Validation:
		A2A	Application header for internal usage. Mandatory for message exchange between SSP and PHA.
<From>		InitiatingEntityIdentification	The entity being the business responsible for submitting this message. The type of identification must be determined when defining the Standards.
		Optional	Validation:
		A2A	[0..1] source - used for Return and Receipt messages only
<Type>-</Type>	4x	Type	The type of identifier. This can be the URI of the registrar of the names.
		Mandatory	Validation:
		A2A	[1..1] only NAME is possible
<Id>-</Id>	30x	Entity Identifier	The actual identification of the entity Indicates PHA. Used for requests only.
		Mandatory	Validation:
		A2A	[1..1]
</From>		End of InitiatingEntityIdentification	
		Optional	Validation:
		A2A	[0..1]
<To>		ReceivingEntityIdentification	The entity that the "From" business entity has chosen to be the business receiver of the message. The type of identification must be determined when defining the Standards.
		Optional	Validation:
		A2A	[0..1] destination - used for Get, Modify, Cancel etc messages only
<Type>-</Type>	4x	Type	The type of identifier. This can be the URI of the registrar of the names.
		Mandatory	Validation:
		A2A	[1..1] only NAME is possible
<Id>-</Id>	30x	Entity Identifier	The actual identification of the entity Indicates PHA. Used for responses only.
		Mandatory	Validation:
		A2A	[1..1]
</To>		End of ReceivingEntityIdentification	
		Optional	Validation:
		A2A	[0..1]
<MsgName>-</MsgName>	30x	MessageName	Identifies the type of business transaction described in the payload.
		Optional	Validation:
			[0..1]The Message Name is optional in response messages, but mandatory for requests.

name of attribute	format	short description	description
<MsgRef>-</MsgRef>	30x	MessageReference	It uniquely identifies a Message from a business application standpoint. It must be unique between a "From" and a "To".
		Mandatory	Validation:
		A2A	[1..1] Not used in SSP
<CrDate>-</CrDate>	ISODateTime	CreationDateTime	Time when the message was created. This is the time the "From" claims to have created the message.
		Mandatory	Validation:
		A2A	[1..1] Time when the message was created
<Dup>		Duplicate Indication	sender of the initial request
		Mandatory	Validation:
			[1..1]
<Ref>-</Ref>		Duplicate Reference	
		Mandatory	Validation:
			[1..1]always "DN" for distinguished name
<Info>-</Info>	100x	Information	Indicates the DN of the initiator (CI)
		Mandatory	Validation:
			[1..1]
</Dup>		End duplicate indication	
		Mandatory	Validation:
			[1..1]
</AppHdr>		End of ApplicationHeader	end of ApplicationHeader
		Mandatory	Validation:
		A2A	

Error Codes:

ApplicationHeaderPHAItern_1

Scope: Sample for Return and Receipt messages

ApplicationHeader	<AppHdr>
InitiatingEntityIdentification	<From>
Type	<Type>NAME</Type>
Entity Identifier	<Id>PHA</Id>
End of InitiatingEntityIdentification	</From>
MessageReference	<MsgRef>void</MsgRef>
CreationDateTime	<CrDate>2007-01-01T12:00:00</CrDate>
Duplicate Indication	<Dup>
Duplicate Reference	<Ref>DN</Ref>
Information	<Info>cn=A2A-Application; ou=Payments; o=DEUTDEFF; o=SWIFT</Info>
End duplicate indication	</Dup>
End of ApplicationHeader	</AppHdr>

ApplicationHeaderPHAItern_2

Scope: Sample for Get, Modify, Cancel etc. messages

ApplicationHeader	<AppHdr>
ReceivingEntityIdentification	<To>
Type	<Type>NAME</Type>
Entity Identifier	<Id>PHA</Id>
End of ReceivingEntityIdentification	</To>
MessageName	<MsgName>fourEyesPrinciple</MsgName>
MessageReference	<MsgRef>void</MsgRef>
CreationDateTime	<CrDate>2007-01-01T12:00:00</CrDate>
Duplicate Indication	<Dup>
Duplicate Reference	<Ref>DN</Ref>
Information	<Info>cn=A2A-Application; ou=Payments; o=DEUTDEFF; o=SWIFT</Info>
End duplicate indication	</Dup>
End of ApplicationHeader	</AppHdr>

6. 2.10 ApplicationHeader T2SI

Cash Management Standard

ApplicationHeader_T2SI

Scope: An Application Header has to be used in all messages the customer client application sends to the TARGET2 server. It addresses the TARGET2 module which has to process the request. If T2SI is the addressed module, the Application Header also enables the sender to name the "work as" BIC required in cases the requestor's DN is linked to several participants.

In responses or push messages from T2SI to the customer client TARGET2 names the sending module - and if "works as" BIC was mentioned in the request, also the BIC of the receiving participant.

For T2SI there are two different schemas available: First schema is used by TARGET2 to validate the Application Header of inbound messages. The second schema will be observed in case of outgoing messages from T2SI. It can be used by customer client to validate the messages he receives. However, here in the UDFS the structure is only explained once.

Structure:

ApplicationHeader	<AppHdr>
InitiatingEntityIdentification	<From>
Type	<Type></Type>
Entity Identifier	<Id></Id>
End of InitiatingEntityIdentification	</From>
ReceivingEntityIdentification	<To>
Type	<Type></Type>
Entity Identifier	<Id></Id>
End of ReceivingEntityIdentification	</To>
MessageReference	<MsgRef></MsgRef>
CreationDateTime	<CrDate></CrDate>
End of ApplicationHeader	</AppHdr>

Attributes:

name of attribute	format	short description	description
<AppHdr>		ApplicationHeader	ApplicationHeader
		Mandatory A2A	Validation: [1..1]
<From>		InitiatingEntityIdentification	The entity being the business responsible for submitting this message. The type of identification must be determined when defining the Standards.
		Optional A2A	Validation: [0..1]Must be present if requestor's DN is linked to several participants.
<Type>-</Type>		Type	The type of identifier. Possible values are: "NAME" = Name of the sending/receiving module. "BIC" = BIC of the direct participant.
		Mandatory A2A	Validation: [1..1]
<Id>-</Id>	30x	Entity Identifier	The actual identification of the entity
		Mandatory A2A	Validation: [1..1]If message is a customer request, a BIC linked to the requestor's DN has to be mentioned.
</From>		End of InitiatingEntityIdentification	
		Optional A2A	Validation: [0..1]
<To>		ReceivingEntityIdentification	The entity that the "From" business entity has chosen to be the business receiver of the message. The type of identification must be determined when defining the Standards.
		Optional A2A	Validation: [0..1]Must be present in case of customer requests.
<Type>-</Type>		Type	The type of identifier. Possible values are: "NAME" = Name of the sending/receiving module. "BIC" = BIC of the direct participant.
		Mandatory A2A	Validation: [1..1]
<Id>-</Id>	30x	Entity Identifier	The actual identification of the entity
		Mandatory A2A	Validation: [1..1]If message is a customer request, the name of addressed module "T2SI" has to be mentioned.
</To>		End of ReceivingEntityIdentification	
		Optional A2A	Validation: [0..1]
<MsgRef>-</MsgRef>	30x	MessageReference	It uniquely identifies a Message from a business application standpoint. It must be unique between a "From" and a "To". The reference received is not processed by TARGET2

name of attribute	format	short description	description
		Mandatory	In messages sent by T2SI it is filled in a copy of MessageID from Document's MessageHeader. Validation: [1..1] none
<CrDate>-</CrDate>	ISODateTime	CreationDateTime	Time when the message was created. This is the time the "From" claims to have created the message. The timestamp is not processed by TARGET2. Validation: [1..1] none
</AppHdr>		End of ApplicationHeader	end of ApplicationHeader Validation: [1..1]

Error Codes:

Order	Error code				Error Text / Validation/ Remark
	SSP	Y-copy	V-shape	XML	
1	X60			1420	Error Text: "Work as" selection mandatory if DN is linked to several participants. Validation: If RequestorDN is linked to several participants, an InitiatingEntityIdentification must be given in Application Header. Remark:
2	X61			1421	Error Text: Requestor DN not linked to the indicated working BIC. Validation: If an InitiatingEntityIdentification is used in Application Header, the RequestorDN must match to the indicated BIC. Remark:

ApplicationHeader_T2SI_1

Scope: Message to T2SI

ApplicationHeader	<AppHdr>
InitiatingEntityIdentification	<From>
Type	<Type>BIC</Type>
Entity Identifier	<Id>MARKDEFFXX</Id>
End of InitiatingEntityIdentification	</From>
ReceivingEntityIdentification	<To>
Type	<Type>NAME</Type>
Entity Identifier	<Id>T2SI</Id>
End of ReceivingEntityIdentification	</To>
MessageReference	<MsgRef>void</MsgRef>
CreationDateTime	<CrDate>2014-11-11T12:00:00</CrDate>
End of ApplicationHeader	</AppHdr>

ApplicationHeader_T2SI_2

Scope: Message pushed by T2SI

ApplicationHeader	<AppHdr>
InitiatingEntityIdentification	<From>
Type	<Type>NAME</Type>
Entity Identifier	<Id>T2SI</Id>
End of InitiatingEntityIdentification	</From>
MessageReference	<MsgRef>132456</MsgRef>
CreationDateTime	<CrDate>2014-11-11T12:00:00</CrDate>
End of ApplicationHeader	</AppHdr>

6. 2.11 ApplicationHeader CRSS (for CBs only)

Cash Management Standard

ApplicationHeader_CRSS

Scope: The ApplicationHeader is used to send billing files to the customer application.

Details will be provided later.

Structure:

Attributes:

Error Codes:

6. 2.12 ApplicationHeader TIPS!

Cash Management Standard

ApplicationHeader_TIPSI

Scope: The ApplicationHeader is send by both the customer client application and by the SSP server together with each message. For incoming messages, the ApplicationHeader must be used to address a message to a certain SSP module. For outgoing messages, the ApplicationHeader reports the module the message is coming from.

Usage
Related module:all

The message contains the following information:
Receiving or emitting module
Date and time when the message is issued.

Technical Examples

A message should be addressed to a certain module. To route the message to the module, the Application Header takes the short name of the addressed module.

- the module name ICM can be used in Receipt messages returned by SSP in case of a severe error. E.g. when no ApplicationHeader was sent in the request and a module can not be evaluated.

Structure:

ApplicationHeader	<AppHdr>
InitiatingEntityIdentification	<From>
Type	<Type>--</Type>
Entity Identifier	<Id>--</Id>
End of InitiatingEntityIdentification	</From>
ReceivingEntityIdentification	<To>
Type	<Type>--</Type>
Entity Identifier	<Id>--</Id>
End of ReceivingEntityIdentification	</To>
MessageReference	<MsgRef>--</MsgRef>
CreationDateTime	<CrDate>--</CrDate>
End of ApplicationHeader	</AppHdr>

Attributes:

name of attribute	format	short description	description
<AppHdr>		ApplicationHeader	ApplicationHeader
		Mandatory	Validation: [1..1]
<From>		InitiatingEntityIdentification	The entity being the business responsible for submitting this message. The type of identification must be determined when defining the Standards.
		Optional	Validation: [0..1]
<Type>-</Type>		Type	The type of identifier.
		Mandatory	Possible values are: "NAME" = Name of the sending/receiving module. "BIC" = BIC of the direct participant. Validation: [1..1]
<Id>-</Id>	30x	Entity Identifier	The actual identification of the entity
		Mandatory	Validation: [1..1]
</From>		End of InitiatingEntityIdentification	
		Optional	Validation: [0..1]
<To>		ReceivingEntityIdentification	The entity that the "From" business entity has chosen to be the business receiver of the message. The type of identification must be determined when defining the Standards.
		Optional	Validation: [0..1]Must be present in case of customer requests.
<Type>-</Type>		Type	The type of identifier.
		Mandatory	Possible values are: "NAME" = Name of the sending/receiving module. "BIC" = BIC of the direct participant. Validation: [1..1]
<Id>-</Id>	30x	Entity Identifier	The actual identification of the entity
		Mandatory	Validation: [1..1]If message is a customer request, the name of addressed module "TIPSI" has to be mentioned.
</To>		End of ReceivingEntityIdentification	
		Optional	Validation: [0..1]
<MsgRef>-</MsgRef>	30x	MessageReference	It uniquely identifies a Message from a business application standpoint. It must be unique between a "From" and a "To".
		Optional	Validation: [1..1]

name of attribute	format	short description	description
<CrDate>-</CrDate>	ISODateTime	CreationDateTime	Time when the message was created. This is the time the "From" claims to have created the message.
		Optional	Validation: [1..1]
</AppHdr>		End of ApplicationHeader	end of ApplicationHeader
		Optional	Validation: [1..1]

Error Codes:

ApplicationHeader_TIPSI_1

Scope:

ApplicationHeader	<AppHdr>
InitiatingEntityIdentification	<From>
Type	<Type>BIC</Type>
Entity Identifier	<Id>MARKDEFFXX X</Id>
End of InitiatingEntityIdentification	</From>
ReceivingEntityIdentification	<To>
Type	<Type>NAME</Type>
Entity Identifier	<Id>TIPSI-</Id>
End of ReceivingEntityIdentification	</To>
MessageReference	<MsgRef>void</MsgRef>
CreationDateTime	<CrDate>2014 -11-11T12:00:00</CrDate>
End of ApplicationHeader	</AppHdr>

ApplicationHeader_TIPSI_2

Scope: Message Scope: pushed by TIPSI

ApplicationHeader	<AppHdr>
InitiatingEntityIdentification	<From>
Type	<Type>NAME</Type>
Entity Identifier	<Id>TIPSI</Id>
End of InitiatingEntityIdentification	</From>
MessageReference	<MsgRef>12345</MsgRef>
CreationDateTime	<CrDate>2014-11-11T12:00:00</CrDate>
End of ApplicationHeader	</AppHdr>

6. 3 Common XML messages

6.3.1 GetBroadcast

SSP Proprietary Messages

GetBroadcast

Scope: The GetBroadcast message is sent to fetch the broadcasts sent to the direct participant during the current business day (or former days, if the expiration date is not yet reached). Independent which SSP module is mentioned within the Application Header, there will be always returned the whole broadcasts to the participant. The customer application has to care or administer by itself, which broadcasts already received and which are new. SSP will not support a status management. Within the Application Header following SSP modules (HAM, PM, RMM, SDM, SFM) can be mentioned.

CB applications will receive

- all broadcasts sent and received by the CB itself
- all received broadcasts related to a specific participant via "works as" or "act on behalf" scenario

All other participants will get

- only broadcasts they are addressee for

In case of broadcasts addressed to a group of receivers, these are only displayed once to the senders side, no matter how many receivers are addressed. On receivers side they are singled, so that each user can confirm the reading of his own broadcast

The GetBroadcast message is replied by a ReturnBroadcast message.

<camt.998.001.xx>

Structure:

Name Proprietary message	<PrtryMsg>
Message Header	<MsgHdr>
Message Identification	<MsgId></MsgId>
End of Message Header	</MsgHdr>
Proprietary Data	<PrtryData>
Proprietary Data type	<Tp>GetBroadcast</Tp>
Proprietary Data	<Data>
SSP Proprietary Data	<SspPrtryDt>
Broadcast Query Definition	<BrdQryDef>
Broadcast Criteria Definition	<BrdCrit>
NewCriteria	<NewCrit>
SearchCriteria	<SchCrit>
Broadcast Details	<Brd>
DateTimePeriodChoice	<DtTmSch>
choice	xorFrDtTmToDtTmDtTmRg
FromDateTime	<FrDtTm></FrDtTm>
ToDateTime	<ToDtTm></ToDtTm>
DateTimeRange	<DtTmRg>
FromDateTime	<FrDtTm></FrDtTm>
ToDateTime	<ToDtTm></ToDtTm>
End of DateTimeRange	</DtTmRg>
End of choice	/xorFrDtTmToDtTmDtTmRg
End of DateTimePeriodChoice	</DtTmSch>
Subject	<Sbjt></Sbjt>
Receiver Information	<RecvrInf>
Responsible Central Bank	<RspnsblCB>
Country Code	<Ctry></Ctry>
End responsible Cental Bank	</RspnsblCB>
Participant BIC	<Ptcpt></Ptcpt>
User Role	<UsrRole></UsrRole>
End of Receiver Information	</RecvrInf>
Broadcast type	<Tp></Tp>
Sender	<Sndr></Sndr>

broadcast status	<Sts></Sts>
End of broadcast details	</Brd>
End of SearchCriteria	</SchCrit>
End of NewCriteria	</NewCrit>
End of Broadcast Criteria Defintion	</BrdCrit>
End of Broadcast Query Definition	</BrdQryDef>
End of SSP Proprietary Data	</SspPrtryDt>
End of Proprietary Data	</Data>
End of Proprietary Data	</PrtryData>
End proprietary message	</PrtryMsg>

Attributes:

name of attribute	format	short description	description
<PrtryMsg>		Name Proprietary message Mandatory A2A	Validation:
<MsgHdr>		Message Header Mandatory A2A	Set of characteristics specific to the message Message Reference Validation: [1..1]
<MsgId>-</MsgId>	35x	Message Identification Mandatory A2A	Message Identification Validation: [1..1]
</MsgHdr>		End of Message Header Mandatory A2A	Validation: [1..1]
<PrtryData>		Proprietary Data Mandatory A2A	Proprietary Data Validation: [1..1]
<Tp>-</Tp>		Proprietary Data type Mandatory A2A	Proprietary Data type here only GetBroadcast is possible Validation: [1..1]
<Data>		Proprietary Data Mandatory	Proprietary data content Validation: [1..1]
<SspPrtryDt>		SSP Proprietary Data Mandatory A2A	Root element for all SSP proprietary data Validation: [1..1]
<BrdQryDef>		Broadcast Query Definition Optional A2A	Broadcast Query Definition Validation: [0..1]
<BrdCrit>		Broadcast Criteria Defintion Optional A2A	Broadcast Criteria Definition Validation: [0..1]
<NewCrit>		NewCriteria Mandatory A2A	Defines the criteria based on which the information is extracted. Validation: [1..1]
<SchCrit>		SearchCriteria Optional A2A	Defines the criteria used to search for. Validation: [0..1] when not stated all broadcasts sent to the participant will be selected

name of attribute	format	short description	description
<Brd>		Broadcast Details	Broadcast Details Search Criteria
		Mandatory	Validation:
		A2A	[1..1]
<DtTmSch>		DateTimePeriodChoice	A choice between various date time patterns.
			FromDateTime [1..1] DateTimePeriodChoice ToDateTime [1..1] DateTimePeriodChoice DateTimeRange [1..1] DateTimePeriodChoice
		Optional	Delivery Date and Time
		A2A	Validation: [0..1] if nothing is selected "ALL" Broadcast Messages are shown
xorFrDtTmToDtTmDtTmRg		choice	choice amongst <FrDtTm>, <ToDtTm> or <DtTmRg>
		Mandatory	Validation:
<FrDtTm>-</FrDtTm>	ISODateTime	FromDateTime	Date and time at which the range starts.
		Mandatory	Validation:
		A2A	[1..1]
<ToDtTm>-</ToDtTm>	ISODateTime	ToDateTime	Date and time at which the range ends.
		Mandatory	Validation:
		A2A	[1..1]
<DtTmRg>		DateTimeRange	Range of time between a start date and time and an end date and time.
		Mandatory	Validation:
		A2A	[1..1]
<FrDtTm>-</FrDtTm>	ISODateTime	FromDateTime	Date and time at which the range starts.
		Mandatory	Validation:
		A2A	[1..1] when not stated all broadcasts sent to the participant will be selected
<ToDtTm>-</ToDtTm>	ISODateTime	ToDateTime	Date and time at which the range ends.
		Mandatory	Validation:
		A2A	[1..1]
</DtTmRg>		End of DateTimeRange	
		Mandatory	Validation:
		A2A	[1..1]
/xorFrDtTmToDtTmDtTmRg		End of choice	end of choice amongst <FrDtTm>, or <ToDtTm> or <DtTmRg>
		Mandatory	Validation:
</DtTmSch>		End of DateTimePeriodChoice	End of DateTimePeriodChoice
		Optional	Validation:
		A2A	[0..1]
<Sbjt>-</Sbjt>	140x	Subject	Subject line summarizing the topic of the information. e.g. NewTarget2Directory, search for respective subject,

name of attribute	format	short description	description
		Optional A2A	wildcards are possible Validation: [0..1]
<RecvrInf>		Receiver Information Optional A2A	Receiver Information: responsible CB, Receiver Participant, User Role free format tag ReceiverDetails Validation: [0..1] all sent and received broadcast only in case of CB user, this function not available for other user profiles
<RspnsblCB>		Responsible Central Bank Optional A2A	Responsible Central Bank The CB's country code will be filled in <Ctry>. Validation: [0..1]
<Ctry>-</Ctry>	2!a	Country Code Mandatory A2A	Country Code Code to identify a country, a dependency, or another area of particular geopolitical interest, on the basis of country names obtained from the United Nations (ISO 3166, Alpha-2 code). Country Code Responsible CB Validation: [1..1]
</RspnsblCB>		End responsible Cental Bank Optional A2A	end responsible Cental Bank Validation: [0..1]
<Ptcpt>-</Ptcpt>	4!a2!a2!c3!c	Participant BIC Optional A2A	Participant BIC if DN is linked to several BIC's --> "works as" scenario otherwise "act on behalf" scenario Validation: [0..1] if nothing is selected all values are searched
<UsrRole>-</UsrRole>	70x	User Role	free format tag Proprietary Role Receiver User Role U2A - following values are possible: CUPAYM CULIQU CULIMI CUBAUP CURMAN CUINFO CUGAMA CURGOA CUCOMA CURCOM HAMANA LVMANA ASMANA ASINFO CSMANA CSINFO TAMANA TAINFR CMMANA CMINFO CBMANA CBSDMA CBINFR CBBILM

name of attribute	format	short description	description
			CBBILR CBCUSM CBCUSR CBEVCM CBEVCR BOMANA BOADMIN BOINFO TOINFO
		Optional A2A	Validation: [0..1] if nothing is selected all values are searched
</RecvrInf>		End of Receiver Information	End of Receiver Information
		Optional A2A	Validation: [0..1]
<Tp>-</Tp>		Broadcast type	Broadcast types: Alert = ALRT used for very important information, directly displayed at receivers side on an additional screen. This information is always captured by CB or SSP. Normal = NORM created in an automatic way by the system in special situations (related to a single message and the related participants) less important information captured by CB or SSP user BroadcastType
		Optional A2A	Validation: [0..1] if nothing is selected all values are searched
<Sndr>-</Sndr>	35x	Sender	free format tag Sender values: SSP operator, CB <CC>, System Sender
		Optional A2A	Validation: [0..1] if nothing is selected all values are searched
<Sts>-</Sts>		broadcast status	free format tag broadcast status RECV = received READ = read DELI = delivered (only for CB's)
		Optional A2A	Validation: [0..1] values for received broadcasts: "received", "read" default value: "received" in case broadcast type = "normal" value for send broadcasts (only for CB available): delivered
</Brd>		End of broadcast details	end broadcast details search criteria
		Mandatory A2A	Validation: [1..1]
</SchCrit>		End of SearchCriteria	End of SearchCriteria
		Optional A2A	Validation: [0..1]

name of attribute	format	short description	description
</NewCrit>		End of NewCriteria	End of NewCriteria
		Mandatory	Validation:
	A2A		[1..1]
</BrdCrit>		End of Broadcast Criteria Definition	End of Broadcast Criteria Definition
		Optional	Validation:
	A2A		[0..1]
</BrdQryDef>		End of Broadcast Query Definition	End of Broadcast Query Definition
		Optional	Validation:
	A2A		[0..1]
</SspPrtryDt>		End of SSP Proprietary Data	End of Root element for all SSP proprietary data
		Mandatory	Validation:
	A2A		[1..1]
</Data>		End of Proprietary Data	
		Mandatory	Validation:
			[1..1]
</PrtryData>		End of Proprietary Data	End of Proprietary Data
		Mandatory	Validation:
	A2A		[1..1]
</PrtryMsg>		End proprietary message	
		Mandatory	Validation:
	A2A		

Error Codes:

Order	Error code				Error Text / Validation/ Remark
	SSP	Y-copy	V-shape	XML	
1	X41			1401	Error Text: No permission. RBAC User role(s) are not sufficient. Validation: RBAC role name "APPLICATE", "APPLICBTE", "APPLICSTE" or "APPLIASTE" are required Remark: checked by ICM / ReturnBroadcast
2	P08			P008	Error Text: You are not allowed to select the element Receiver Information Validation: <RecvrInf>-</RecvrInf> all sent and received broadcast only in case of CB user, this function not available for other user profiles Remark: checked by ICM / ReturnBroadcast
3	P09			P009	Error Text: You are not allowed to select this broadcast status Validation: Broadcast Status<Sts>-</Sts> values for send broadcasts (only for CB available): "delivered" Remark: checked by ICM / ReturnBroadcast
4	862	C2	TM01	2862	Error Text: Request out of cut-off time Validation: Possibility to use this function during the current phase of business day. Remark: checked by PM / ReturnBroadcast
5	P24			P024	Error Text: No Broadcast Information found Validation: available Broadcast Information Remark: ReturnBroadcast
6	X40			1400	Error Text: BIC must indicate a SSP participant Validation: <Ptcpt> must indicate a SSP Participant. Remark: checked by ICM / ReturnBroadcast
7	X42			1402	Error Text: No authorisation. User is not allowed acting on behalf of another participant. Validation: <Ptcpt> must indicate a participant who the CB is responsible for. Remark: checked by ICM / ReturnBroadcast

GetBroadcast _1

Scope: Get Broadcast request with all possible search criteria (Requestor CB -> "act on behalf" scenario)

Name Proprietary message	<PrtryMsg>
Message Header	<MsgHdr>
Message Identification	<MsgId>ABC123</MsgId>
End of Message Header	</MsgHdr>
Proprietary Data	<PrtryData>
Proprietary Data type	<Tp>GetBroadcast</Tp>
Proprietary Data	<Data>
SSP Proprietary Data	<SspPrtryDt>
Broadcast Query Definition	<BrdQryDef>
Broadcast Criteria Definition	<BrdCrit>
NewCriteria	<NewCrit>
SearchCriteria	<SchCrit>
Broadcast Details	<Brd>
DateTimePeriodChoice	<DtTmSch>
FromDateTime	<FrDtTm>2005-07-21T08:35:30</FrDtTm>
End of DateTimePeriodChoice	</DtTmSch>
Subject	<Sbjt>Information period of Bilateral Settlement for AS is started</Sbjt>
Receiver Information	<RecvrInf>
Participant BIC	<Ptcpt>DEUTDEFFXXX</Ptcpt>
User Role	<UsrRole>CUPAYM</UsrRole>
End of Receiver Information	</RecvrInf>
Broadcast type	<Tp>NORM</Tp>
Sender	<Sndr>SSP operator</Sndr>
broadcast status	<Sts>RECV</Sts>
End of broadcast details	</Brd>
End of SearchCriteria	</SchCrit>
End of NewCriteria	</NewCrit>
End of Broadcast Criteria Definition	</BrdCrit>
End of Broadcast Query Definition	</BrdQryDef>
End of SSP Proprietary Data	</SspPrtryDt>
End of Proprietary Data	</Data>
End of Proprietary Data	</PrtryData>
End proprietary message	</PrtryMsg>

GetBroadcast _2

Scope: Get Broadcast request with all broadcasts since a certain time

Name Proprietary message	<PrtryMsg>
Message Header	<MsgHdr>
Message Identification	<MsgId>ABC123</MsgId>
End of Message Header	</MsgHdr>
Proprietary Data	<PrtryData>
Proprietary Data type	<Tp>GetBroadcast</Tp>
Proprietary Data	<Data>
SSP Proprietary Data	<SspPrtryDt>
Broadcast Query Definition	<BrdQryDef>
Broadcast Criteria Defintion	<BrdCrit>
NewCriteria	<NewCrit>
SearchCriteria	<SchCrit>
Broadcast Details	<Brd>
DateTimePeriodChoice	<DtTmSch>
FromDateTime	<FrDtTm>2012-07-21T08:35:30</FrDtTm>
End of DateTimePeriodChoice	</DtTmSch>
End of broadcast details	</Brd>
End of SearchCriteria	</SchCrit>
End of NewCriteria	</NewCrit>
End of Broadcast Criteria Defintion	</BrdCrit>
End of Broadcast Query Definition	</BrdQryDef>
End of SSP Proprietary Data	</SspPrtryDt>
End of Proprietary Data	</Data>
End of Proprietary Data	</PrtryData>
End proprietary message	</PrtryMsg>

6. 3. 2 GetPendingData

SSP Proprietary Messages

GetPendingData

Scope: The GetPendingData message is sent to asynchronously retrieve the result of a previous inquiry that was disrupted by the ICM server because of a timeout event.
 "Timeout event" in this context means that the execution of the request received by the ICM server takes longer than the allowed time. Therefore it was distributed by the ICM server. Within the Application Header following SSP modules (HAM, PM, RMM, SDM, SFM and PHA) can be mentioned.

The GetPendingData message can be sent by the application of a direct PM participant.

The GetPendingData message will be replied by the XML response related to the previously sent XML request. The information given with the response message is the input for the GetPendingData message as follows.

Response elements:

- RltdRef/Ref or
- Rela/Ref or
- BizQryRef/QryRef

<camt.998.001.xx>

Structure:

Name Proprietary message	<PrtryMsg>
Message Header	<MsgHdr>
Message Identification	<MsgId></MsgId>
End of Message Header	</MsgHdr>
Proprietary Data	<PrtryData>
Proprietary Data type	<Tp>GetPendingData</Tp>
Proprietary Data	<Data>
SSP Proprietary Data	<SspPrtryDt>
PendingDataQueryDefinition	<PndDtQryDef>
PendingDataCriteria	<PndDtCrit>
NewCriteria	<NewCrit>
SearchCriteria	<SchCrit>
Additional Reference	<RltdRef>
Reference	<Ref></Ref>
End of Additional Reference	</RltdRef>
End of SearchCriteria	</SchCrit>
End of NewCriteria	</NewCrit>
End of PendingDataCriteria	</PndDtCrit>
End of PendingDataQueryDefinition	</PndDtQryDef>
End of SSP Proprietary Data	</SspPrtryDt>
End of Proprietary Data	</Data>
End of Proprietary Data	</PrtryData>
End proprietary message	</PrtryMsg>

Attributes:

name of attribute	format	short description	description
<PrtryMsg>		Name Proprietary message Mandatory A2A	Validation:
<MsgHdr>		Message Header Mandatory A2A	Set of characteristics specific to the message Message Reference Validation: [1..1]
<MsgId>-</MsgId>	35x	Message Identification Mandatory A2A	Message Identification Validation: [1..1]
</MsgHdr>		End of Message Header Mandatory A2A	Validation: [1..1]
<PrtryData>		Proprietary Data Mandatory A2A	Proprietary Data Validation: [1..1]
<Tp>-</Tp>		Proprietary Data type Mandatory A2A	Proprietary Data type Validation: [1..1] here only GetPendingData is possible
<Data>		Proprietary Data Mandatory	Proprietary data content Validation: [1..1]
<SspPrtryDt>		SSP Proprietary Data Mandatory A2A	Root element for all SSP proprietary data Validation: [1..1]
<PndDtQryDef>		PendingDataQueryDefinitio n Mandatory A2A	PendingDataQueryDefinition Validation: [1..1]
<PndDtCrit>		PendingDataCriteria Mandatory A2A	PendingDataCriteria Validation: [1..1]
<NewCrit>		NewCriteria Mandatory A2A	Validation: [1..1]
<SchCrit>		SearchCriteria Mandatory A2A	Validation: [1..1]
<RltdRef>		Additional Reference Mandatory	Additional Reference Pending Data Identification Validation:

name of attribute	format	short description	description
		A2A	[1..1]
<Ref>-</Ref>	35x	Reference	Unique and unambiguous reference The timeout status message (Receipt or Return message) includes the related reference for the later access to the data. The exact returned element depends on the type of message: Returned SWIFT standard, Receipt or SSP proprietary
		Mandatory	Validation: [1..1]
		A2A	[1..1]
</RltdRef>		End of Additional Reference	End of Additional Reference
		Mandatory	Validation: [1..1]
		A2A	[1..1]
</SchCrit>		End of SearchCriteria	
		Mandatory	Validation: [1..1]
		A2A	[1..1]
</NewCrit>		End of NewCriteria	
		Mandatory	Validation: [1..1]
		A2A	[1..1]
</PndDtCrit>		End of PendingDataCriteria	
		Mandatory	Validation: [1..1]
		A2A	[1..1]
</PndDtQryDef>		End of PendingDataQueryDefinition	End of PendingDataQueryDefinition
		Mandatory	Validation: [1..1]
		A2A	[1..1]
</SspPrtryDt>		End of SSP Proprietary Data	End of Root element for all SSP proprietary data
		Mandatory	Validation: [1..1]
		A2A	[1..1]
</Data>		End of Proprietary Data	
		Mandatory	Validation: [1..1]
</PrtryData>		End of Proprietary Data	End of Proprietary Data
		Mandatory	Validation: [1..1]
		A2A	[1..1]
</PrtryMsg>		End proprietary message	
		Mandatory	Validation: [1..1]
		A2A	[1..1]

Error Codes:

Order	Error code				Error Text / Validation/ Remark
	SSP	Y-copy	V-shape	XML	
1	X02			1002	Error Text: Data not yet available Validation: After the execution timeout the pending data must have been prepared in the background Remark: try again later Response: Receipt
2	X05			1005	Error Text: Data not available Validation: The related reference ("RltdRef") must indicate an existing pending data. The pending data must not have been retrieved before. Remark: Receipt
3	862	C2	TM01	2862	Error Text: Request out of cut-off time Validation: Possibility to use this function during the current phase of business day. Remark: checked by SSP

GetPendingData_1

Scope: Sample:

Name Proprietary message	<PrtryMsg>
Message Header	<MsgId>
Message Identification	<MsgId>ABC123</MsgId>
End of Message Header	</MsgId>
Proprietary Data	<PrtryData>
Proprietary Data type	<Tp>GetPendingData</Tp>
Proprietary Data	<Data>
SSP Proprietary Data	<SspPrtryDt>
PendingDataQueryDefinition	<PndDtQryDef>
PendingDataCriteria	<PndDtCrit>
NewCriteria	<NewCrit>
SearchCriteria	<SchCrit>
Additional Reference	<RltdRef>
Reference	<Ref>ABCDEFGHIJKLMN OPQRSTUVWXYZ12345678 9</Ref>
End of Additional Reference	</RltdRef>
End of SearchCriteria	</SchCrit>
End of NewCriteria	</NewCrit>
End of PendingDataCriteria	</PndDtCrit>
End of PendingDataQueryDefinition	</PndDtQryDef>
End of SSP Proprietary Data	</SspPrtryDt>
End of Proprietary Data	</Data>
End of Proprietary Data	</PrtryData>
End proprietary message	</PrtryMsg>

6. 3. 3 GetSystemTime

SSP Proprietary Messages

GetSystemTime

Scope: The GetSystemTime message is sent to receive the system time of the SSP. It can be used to check the connection between the application of the direct PM participant and the ICM server. Within the Application Header following SSP modules (HAM, PM, RMM, SDM, SFM and PHA) can be mentioned, the result is always the same system time.

The GetSystemTime message can be sent by the application of a any participant in SSP.

The GetSystemTime message is replied by a ReturnSystemTime message.

The execution of the GetSystemTime message requires no RBA role. Every customer client application who has access to the SSP service is allowed to execute the connection test.

<camt.998.001.xx>

Structure:

Name Proprietary message	<PrtryMsg>
Message Header	<MsgHdr>
Message Identification	<MsgId></MsgId>
End of Message Header	</MsgHdr>
Proprietary Data	<PrtryData>
Proprietary Data type	<Tp>GetSystemTime</Tp>
Proprietary Data	<Data>
SSP Proprietary Data	<SspPrtryDt>
System Time Query Definition	<SysTmQryDef/>
End of SSP Proprietary Data	</SspPrtryDt>
End of Proprietary Data	</Data>
End of Proprietary Data	</PrtryData>
End proprietary message	</PrtryMsg>

Attributes:

name of attribute	format	short description	description
<PrtryMsg>		Name Proprietary message Mandatory A2A	Validation:
<MsgHdr>		Message Header Mandatory A2A	Set of characteristics specific to the message Validation: [1..1]
<MsgId>-</MsgId>	35x	Message Identification Mandatory A2A	Message Identification Message Reference Validation: [1..1]
</MsgHdr>		End of Message Header Mandatory A2A	Validation: [1..1]
<PrtryData>		Proprietary Data Mandatory A2A	Proprietary Data Validation: [1..1]
<Tp>-</Tp>		Proprietary Data type Mandatory A2A	Proprietary Data type Validation: [1..1]
<Data>		Proprietary Data Mandatory	Proprietary data content Validation: [1..1]
<SspPrtryDt>		SSP Proprietary Data Mandatory A2A	Root element for all SSP proprietary data Validation: [1..1]
<SysTmQryDef>	empty	System Time Query Definition Mandatory A2A	System Time Query Definition Validation: [1..1]
</SspPrtryDt>		End of SSP Proprietary Data Mandatory A2A	End of Root element for all SSP proprietary data Validation: [1..1]
</Data>		End of Proprietary Data Mandatory	Validation: [1..1]
</PrtryData>		End of Proprietary Data Mandatory A2A	End of Proprietary Data Validation: [1..1]
</PrtryMsg>		End proprietary message Mandatory	Validation:

name of attribute	format	short description	description
-------------------	--------	-------------------	-------------

A2A

Error Codes:

GetSystemTime_1

Scope: Sample:

Name Proprietary message	<PrtryMsg>
Message Header	<MsgId>
Message Identification	<MsgId>ABC123</MsgId>
End of Message Header	</MsgHdr>
Proprietary Data	<PrtryData>
Proprietary Data type	<Tp>GetSystemTime</Tp>
Proprietary Data	<Data>
SSP Proprietary Data	<SspPrtryDt>
System Time Query Definition	<SysTmQryDef/>
End of SSP Proprietary Data	</SspPrtryDt>
End of Proprietary Data	</Data>
End of Proprietary Data	</PrtryData>
End proprietary message	</PrtryMsg>

6.3.4 GetTask

SSP Proprietary Messages

GetTask

Scope: The GetTask message is sent by the customer client application to the SSP server. It is used to query the task queue of a single SSP module.

Related SSP modules: HAM, PM, RMM, SDM, SFM or PHA

The query can be either the search for all tasks with a certain status, or the search for a certain task with a given reference. To retrieve the whole task queue of a SSP module, the query can be executed with no constrains. The query can be executed on behalf of a third party in case of CB. The participant who inserted the task in the task queue has access only to it's own tasks, with the exception of Central Banks.

The GetTask message can be sent by the application of any participant in SSP.

The GetTask message will be replied by a ReturnTask message.

<camt.998.001.xx>

Structure:

Name Proprietary message	<PrtryMsg>
Message Header	<MsgHdr>
Message Identification	<MsgId></MsgId>
End of Message Header	</MsgHdr>
Proprietary Data	<PrtryData>
Proprietary Data type	<Tp>GetTask</Tp>
Proprietary Data	<Data>
SSP Proprietary Data	<SspPrtryDt>
TaskQueryDefinition	<TskQryDef>
TaskCriteriaDefinition	<TskCrit>
NewCriteria	<NewCrit>
SearchCriteria	<SchCrit>
choice amongst	xorTskIdTskSts
TaskIdentificationSearchCriteria	<TskId>
Additional Reference	<RltdRef>
Reference	<Ref></Ref>
End of Additional Reference	</RltdRef>
End of TaskIdentificationSearchCriteria	</TskId>
TaskStatus	<TskSts></TskSts>
End choice amongst	/xorTskIdTskSts
Requestor	<Reqr>
BIC	<BIC></BIC>
End Requestor	</Reqr>
End of SearchCriteria	</SchCrit>
End of NewCriteria	</NewCrit>
End of TaskCriteriaDefinition	</TskCrit>
End of TaskQueryDefinition	</TskQryDef>
End of SSP Proprietary Data	</SspPrtryDt>
End of Proprietary Data	</Data>
End of Proprietary Data	</PrtryData>
End proprietary message	</PrtryMsg>

Attributes:

name of attribute	format	short description	description
<PrtryMsg>		Name Proprietary message Mandatory A2A	Validation:
<MsgHdr>		Message Header Mandatory A2A	Set of characteristics specific to the message Message Reference Validation: [1..1]
<MsgId>-</MsgId>	35x	Message Identification Mandatory A2A	Message Identification Validation: [1..1]
</MsgHdr>		End of Message Header Mandatory A2A	Validation: [1..1]
<PrtryData>		Proprietary Data Mandatory A2A	Proprietary Data Validation: [1..1]
<Tp>-</Tp>		Proprietary Data type Mandatory A2A	Proprietary Data type Validation: [1..1] here only GetTask is possible
<Data>		Proprietary Data Mandatory	Proprietary data content Validation: [1..1]
<SspPrtryDt>		SSP Proprietary Data Mandatory A2A	Root element for all SSP proprietary data Validation: [1..1]
<TskQryDef>		TaskQueryDefinition Mandatory A2A	TaskQueryDefinition Validation: [1..1]
<TskCrit>		TaskCriteriaDefinition Optional A2A	TaskCriteriaDefintion Validation: [0..1]
<NewCrit>		NewCriteria Mandatory A2A	Validation: [1..1]
<SchCrit>		SearchCriteria Mandatory A2A	Defines the criteria used to search for. Validation: [1..1] when not stated all tasks captured by all users of the participant will be selected
xorTskldTskSts		choice amongst	choice amongst Tskld or TskSts

name of attribute	format	short description	description
		Optional	Validation:
<TskId>		TaskIdentificationSearchCriteria	TaskIdentificationSearchCriteria
		Mandatory	Validation:
		A2A	[0..1]
<RltdRef>		Additional Reference	Additional Reference
		Mandatory	Validation:
		A2A	[1..1]
<Ref>-</Ref>	35x	Reference	Unique and unambiguous reference
		Mandatory	Validation:
		A2A	[1..1]
</RltdRef>		End of Additional Reference	End of Additional Reference
		Mandatory	Validation:
		A2A	[1..1]
</TskId>		End of TaskIdentificationSearchCriteria	end of TaskIdentificationSearchCriteria
		Mandatory	Validation:
		A2A	[0..1]
<TskSts>-</TskSts>		TaskStatus	TaskStatus
		Optional	Validation:
		A2A	[0..1] possible values: "toConfirm" "waiting" "processing" "revoked" "rejected" "completed" "pending" and "partiallyPending" (only relevant for module PM, in combination with other modules these statuses are not allowed)
/xorTskIdTskSts		End choice amongst	end choice amongst TaskIdentification and TaskStatus
		Optional	Validation:
		A2A	
<Reqr>		Requestor	Requestor used on behalf of third parties or used to indicate the "work as" BIC if the requestor DN is linked to several BICs.
		Optional	Validation:
		A2A	[0..1] The on behalf scenario is supported for Central Banks, only. CBs can request for all tasks captured by an initiator, for which the CB is responsible for. A co-manager and a GoA manager has only access to tasks he inserted in the task queue on his own. They have no access on tasks inserted by a co-managed participant or a member of group of accounts. Requestor BIC is the co-manager or GoA manager: tasks they have inserted for their own account, and tasks - if they have inserted - on behalf of their participant. Requestor BIC is a co-managed participant or member of a group of accounts: tasks the participant has inserted for his own account.

name of attribute	format	short description	description
<BIC>-</BIC>	11x	BIC	BICIdentifier Code allocated to financial institutions by the Registration Authority, under an international identification scheme, as described in the latest version of the standard ISO 9362 "Banking - Banking telecommunication messages - Bank Identifier Codes". SWIFT is the Registration Authority for ISO 9362. Mandatory: A2A Validation: [1..1]when not stated the BIC of the participant is used
</Req>		End Requestor	End Requestor Optional: A2A Validation: [0..1]
</SchCrit>		End of SearchCriteria	End of SearchCriteria Mandatory: A2A Validation: [1..1]
</NewCrit>		End of NewCriteria	End of NewCriteria Mandatory: A2A Validation: [1..1]
</TskCrit>		End of TaskCriteriaDefinition	End of TaskCriteriaDefintion Optional: A2A Validation: [0..1]
</TskQryDef>		End of TaskQueryDefinition	End of TaskQueryDefinition Mandatory: A2A Validation: [1..1]
</SspPrtryDt>		End of SSP Proprietary Data	End of Root element for all SSP proprietary data Mandatory: A2A Validation: [1..1]
</Data>		End of Proprietary Data	End of Proprietary Data Mandatory: Validation: [1..1]
</PrtryData>		End of Proprietary Data	End of Proprietary Data Mandatory: A2A Validation: [1..1]
</PrtryMsg>		End proprietary message	End proprietary message Mandatory: A2A Validation:

Error Codes:

Order	Error code				Error Text / Validation/ Remark
	SSP	Y-copy	V-shape	XML	
1	X41			1401	<p>Error Text: No permission. RBAC User role(s) are not sufficient.</p> <p>Validation: RBAC role name "APPLICATE", "APPLICBTE", "APPLICSTE" or "APPLIASTE" are required</p> <p>Remark: checked by ICM/ ReturnTask</p>
2	X34			1304	<p>Error Text: No task-queue information found</p> <p>Validation: tasks have to be available for the A2A requests. Certain tasks are only available via U2A</p> <p>Remark: No element in the returnTask to return an operating error / Receipt</p>
2	X34			1304	<p>Error Text: No task-queue information found</p> <p>Validation: <RltdRef><Ref> The query must at least result to one task or one task must be found</p> <p>Remark: No element in the returnTask to return an operating error / Receipt</p>
3	X34			1304	<p>Error Text: No task-queue information found</p> <p>Validation: <TskSts></TskSts> the query must at least result to one task or one task must be found</p> <p>Remark: No element in the returnTask to return an operating error / Receipt</p>
4	X42			1402	<p>Error Text: No authorisation. User is not allowed acting on behalf of another participant.</p> <p>Validation: Reqr/BIC (profile Credit Institution) value must indicate the CI itself</p> <p>Remark: checked by ICM/ ReturnTask</p>
5	X45			1405	<p>Error Text: No authorisation or rather interaction not possible. User is not allowed acting on behalf of another participant as Group of Account manager</p> <p>Validation: Reqr/BIC (profile Group of Accounts manager) value must indicate the GoA manager</p> <p>Remark: checked by ICM/ ReturnTask</p>
6	X47			1407	<p>Error Text: No authorisation. User is not allowed acting on behalf of another Participant as Central Bank</p> <p>Validation: Reqr/BIC (profile Central Bank) value must indicate the CB itself or a participant who is managed by the CB</p> <p>Remark: checked by ICM/ ReturnTask</p>
7	H01		XI01	H001	<p>Error Text: Sender not allowed</p> <p>Validation: The participant who inserted the task in the task queue, has only access to ist own tasks, he has inserted directly (e.g. co-managers have no access right to task inserted by co-managed participants)</p> <p>Remark: checked by HAM/ ReturnTask</p>
8	H01		XI01	H001	<p>Error Text: Sender not allowed</p> <p>Validation: The participant who inserted the task in the task queue, has only access to ist own tasks, he has inserted directly (e.g. co-managers have no access right to task inserted by co-managed participants)</p> <p>Remark: checked by SF/ ReturnTask</p>
9	862	C2	TM01	2862	<p>Error Text: Request out of cut-off time</p> <p>Validation: Possibility to use this function during the current phase of business day.</p> <p>Remark: checked by PM / ReturnTask</p>
10	X34			1304	<p>Error Text: No task-queue information found</p>

Order	Error code				Error Text / Validation/ Remark
	SSP	Y-copy	V-shape	XML	

Validation: The search with status "pending" is only allowed in combination with related module PM.

Remark: No element in the returnTask to return an operating error
/ Receipt

GetTask_1

Scope: Sample: Query for all tasks with certain status

Name Proprietary message	<PrtryMsg>
Message Header	<MsgHdr>
Message Identification	<MsgId>ABC123</MsgId>
End of Message Header	</MsgHdr>
Proprietary Data	<PrtryData>
Proprietary Data type	<Tp>GetTask</Tp>
Proprietary Data	<Data>
SSP Proprietary Data	<SspPrtryDt>
TaskQueryDefinition	<TskQryDef>
TaskCriteriaDefinition	<TskCrit>
NewCriteria	<NewCrit>
SearchCriteria	<SchCrit>
TaskStatus	<TskSts>toConfirm</TskSts>
End of SearchCriteria	</SchCrit>
End of NewCriteria	</NewCrit>
End of TaskCriteriaDefinition	</TskCrit>
End of TaskQueryDefinition	</TskQryDef>
End of SSP Proprietary Data	</SspPrtryDt>
End of Proprietary Data	</Data>
End of Proprietary Data	</PrtryData>
End proprietary message	</PrtryMsg>

GetTask_2

Scope: Sample: Query for certain task

Name Proprietary message	<PrtryMsg>
Message Header	<MsgHdr>
Message Identification	<MsgId>ABC123</MsgId>
End of Message Header	</MsgHdr>
Proprietary Data	<PrtryData>
Proprietary Data type	<Tp>GetTask</Tp>
Proprietary Data	<Data>
SSP Proprietary Data	<SspPrtryDt>
TaskQueryDefinition	<TskQryDef>
TaskCriteriaDefinition	<TskCrit>
NewCriteria	<NewCrit>
SearchCriteria	<SchCrit>
TaskIdentificationSearchCriteria	<TskId>
Additional Reference	<RltdRef>
Reference	<Ref>ABCDEFGHIJKLMNO1234</Ref>
End of Additional Reference	</RltdRef>
End of TaskIdentificationSearchCriteria	</TskId>
End of SearchCriteria	</SchCrit>
End of NewCriteria	</NewCrit>
End of TaskCriteriaDefinition	</TskCrit>
End of TaskQueryDefinition	</TskQryDef>
End of SSP Proprietary Data	</SspPrtryDt>
End of Proprietary Data	</Data>
End of Proprietary Data	</PrtryData>
End proprietary message	</PrtryMsg>

GetTask_3

Scope: Sample: Query without constraint

Name Proprietary message	<PrtryMsg>
Message Header	<MsgHdr>
Message Identification	<MsgId>ABC123</MsgId>
End of Message Header	</MsgHdr>
Proprietary Data	<PrtryData>
Proprietary Data type	<Tp>GetTask</Tp>
Proprietary Data	<Data>
SSP Proprietary Data	<SspPrtryDt>
TaskQueryDefinition	<TskQryDef/>
End of SSP Proprietary Data	</SspPrtryDt>
End of Proprietary Data	</Data>
End of Proprietary Data	</PrtryData>
End proprietary message	</PrtryMsg>

GetTask_4

Scope: GetTask request on behalf of third party

Name Proprietary message	<PrtryMsg>
Message Header	<MsgHdr>
Message Identification	<MsgId>ABC123</MsgId>
End of Message Header	</MsgHdr>
Proprietary Data	<PrtryData>
Proprietary Data type	<Tp>GetTask</Tp>
Proprietary Data	<Data>
SSP Proprietary Data	<SspPrtryDt>
TaskQueryDefinition	<TskQryDef>
TaskCriteriaDefinition	<TskCrit>
NewCriteria	<NewCrit>
SearchCriteria	<SchCrit>
Requestor	<Reqr>
BIC	<BIC>DEUTDEFF</BIC>
End Requestor	</Reqr>
End of SearchCriteria	</SchCrit>
End of NewCriteria	</NewCrit>
End of TaskCriteriaDefinition	</TskCrit>
End of TaskQueryDefinition	</TskQryDef>
End of SSP Proprietary Data	</SspPrtryDt>
End of Proprietary Data	</Data>
End of Proprietary Data	</PrtryData>
End proprietary message	</PrtryMsg>

6. 3. 5 Receipt

Cash Management Standard

Receipt

Scope: The Receipt message is used to return a technical response to the application of the participant.

It is used for the following purposes:

Response to Delete- and Modify- messages:

- Statement of a technical error message: If applicable, a related reference for the subsequent protocol messages is returned
- Confirmation, that a task is stored in the task queue: a related reference (i.e. the task-Id) for the subsequence processing (e.g. confirmation) of the task is returned

Response to Get-messages:

Indication of a serious error, e. g. when the type of message can not be evaluated or is unknown

Success means:

- the task is o.k. from technical point of view
- the task has been inserted in the task queue

Error means:

- during the input processing an error has occurred
- the task has not been inserted in the task queue

The connected request is performed e.g. by the following messages

- BackupPayment
- CancelTransaction
- DeleteLimit
- DeleteReservation
- LiquidityCreditTransfer
- ModifyCreditLine
- ModifyLimit
- ModifyReservation
- ModifyStandingOrder
- ModifyTransaction
- ReleasePayment
- RevokeTask

<camt.025.001.xx>

Structure:

message name receipt	<Rct>
Message Header	<MsgHdr>
Message Identification	<MsgId></MsgId>
End of Message Header	</MsgHdr>
Receipt details	<RctDtls>
original message ID	<OrgnMsgId>
Message Identification	<MsgId></MsgId>
End of Original Message ID	</OrgnMsgId>
RequestHandling	<ReqHdlg>
StatusCode	<StsCd></StsCd>
Description	<Desc></Desc>
End of Request Handling	</ReqHdlg>
End of Receipt details	</RctDtls>
End message name Receipt	</Rct>

Attributes:

name of attribute	format	short description	description
<Rct>		message name receipt Mandatory A2A	Validation:
<MsgHdr>		Message Header Mandatory A2A	Set of characteristics specific to the message Validation: [1..1]
<MsgId>-</MsgId>	35x	Message Identification Mandatory A2A	Message Identification Validation: [1..1]
</MsgHdr>		End of Message Header Mandatory A2A	Validation: [1..1]
<RctDtls>		Receipt details Mandatory	may be multiple in case of deletion/modification of several standing order or current limits Validation: [1..n]
<OrgnlMsgId>		original message ID Optional A2A	Additional Reference Reference to the task, generated by SSP module Validation: [0..1]successful write operation: task identification, status codes 1001 and 1003: protocol data identification, other: reference to the query In case of an error Message Id of the request
<MsgId>-</MsgId>	35x	Message Identification Mandatory A2A	Message Identification In a Receipt for ModifyLimit_SD the task queue reference will be replaced by bilateral counterpart or codeword MULT. Validation: [1..1] Reference according to the initiating message. = Reference of the task (e. g.needed for GetTask message) or in case an error is reported the original <MsgId> of the initiating request
</OrgnlMsgId>		End of Original Message ID Optional A2A	End of Original Message ID Validation: [0..1]
<ReqHdlg>		RequestHandling Mandatory A2A	Gives the status of the request. StatusCode Description technical error Validation: ****[1..1]differs from the CashManagementStandard in SSP should be mandatory [1..1]
<StsCd>-</StsCd>	4lx	StatusCode	Specifies the status of the request. Specifies an alphanumeric string with a maximum length of 4 characters.

name of attribute	format	short description	description
			XML Name: Max4AlphaNumericText XML Type: string Example: aBc9 Separate Specification see UDFS Error Codes
		Mandatory A2A	Validation: [1..1]
<Desc></Desc>	140x	Description	Specification of the error, in free format.
		Optional A2A	Validation: [0..1]
</ReqHdlg>		End of Request Handling	End of Request Handling
		Mandatory A2A	Validation: *****[1..1]
</RctDtls>		End of Receipt details	
		Mandatory	Validation: [1..n]
</Rct>		End message name Receipt	
		Mandatory A2A	Validation:

Error Codes:

Order	Error code				Error Text / Validation/ Remark
	SSP	Y-copy	V-shape	XML	
1	X00			0000	Error Text: O.k. Validation: Confirmation, that a task is stored in the task queue. A related reference for the subsequent processing (e.g. confirmation) of the task is returned. Remark:
2	X01			1001	Error Text: Execution timeout limit exceeded Validation: The execution must not take longer than 30 sec. Remark:
3	X02			1002	Error Text: Data not yet available Validation: Remark:
4	X03			1003	Error Text: Message size limit exceeded Validation: The size of the response must not be larger than the maximum size for SWIFTnet InterAct. Remark: This size is defined by SSP and considerably lower than 100.000 Byte. Remark:
5	X04			1004	Error Text: File size limit exceeded (Sw:RejectDescription) Validation: Remark:
6	X05			1005	Error Text: Data not available Validation: Remark:
7	X07			1101	Error Text: An application header must be sent with each message Validation: Remark:
8	X08			1102	Error Text: The payload must not be empty Validation: Remark:
10	X11			1199	Error Text: free text (parser output) Validation: Remark:
11	X34			1304	Error Text: No task-queue information found Validation: Remark:
12	X35			1305	Error Text: The query name is not related to a previous query. Validation: Remark:
13	X22			9999	Error Text: General system error Validation:

Order	Error code				Error Text / Validation/ Remark
	SSP	Y-copy	V-shape	XML	

Remark:

14	X44			1404	<p>Error Text: If "non repudiation of emission" is mandatory, the NRE indicator flag has to be present</p> <p>Validation: If non-repudiaton processing is mandatory, the tag <SwInt:NRIndicator>TRUE</SwInt:NRIndicator> has to be present.</p> <p>Remark:</p>
15	X42			1402	<p>Error Text: No authorisation. User is not allowed acting on behalf of another participant.</p> <p>Validation:</p> <p>Remark:</p>
16	X43			1403	<p>Error Text: No permission. At least one RBAC role is reserved in A2A mode only but used in U2A</p> <p>Validation:</p> <p>Remark:</p>
17	X45			1405	<p>Error Text: No authorisation or rather interaction not possible. User is not allowed acting on behalf of another participant as Group of Account manager</p> <p>Validation:</p> <p>Remark:</p>
18	X47			1407	<p>Error Text: No authorisation. User is not allowed acting on behalf of another Participant as Central Bank</p> <p>Validation:</p> <p>Remark:</p>
19	X48			1408	<p>Error Text: Interaction only possible for the virtual account manager</p> <p>Validation:</p> <p>Remark:</p>
20	X49			1409	<p>Error Text: No permission. At least one RBAC role is reserved in U2A mode only but used in A2A</p> <p>Validation:</p> <p>Remark:</p>
21	862	C2	TM01	2862	<p>Error Text: Request out of cut-off time</p> <p>Validation: Possibility to use this function during the current phase of business day.</p> <p>Remark:</p>

Receipt_1

Scope: Sample: Execution timeout limit exceeded

message name receipt	<Rct>
Message Header	<MsgHdr>
Message Identification	<MsgId>ABCD1234</MsgId>
End of Message Header	</MsgId>
Receipt details	<RctDtls>
original message ID	<OrgnMsgId>
Message Identification	<MsgId>ABCDEFGHIJKLMNPOQRSTUVWXYZ</MsgId>
End of Original Message ID	</OrgnMsgId>
RequestHandling	<ReqHdlg>
StatusCode	<StsCd>1001</StsCd>
Description	<Desc>Execution timeout limit exceeded</Desc>
End of Request Handling	</ReqHdlg>
End of Receipt details	</RctDtls>
End message name Receipt	</Rct>

Receipt_2

Scope: Sample: Data not yet available

message name receipt	<Rct>
Message Header	<MsgHdr>
Message Identification	<MsgId>ABCDEFGHIJKLMNQRST123456789012345</MsgId>
End of Message Header	</MsgHdr>
Receipt details	<RctDtls>
original message ID	</MsgHdr>
Message Identification	<MsgId>ABCDEFGHIJKLMNQRSTUWXYZ</MsgId>
End of Original Message ID	</OrgnMsgId>
RequestHandling	<ReqHdlg>
StatusCode	<StsCd>1002</StsCd>
Description	<Desc>Data not yet available</Desc>
End of Request Handling	</ReqHdlg>
End of Receipt details	</RctDtls>
End message name Receipt	</Rct>

Receipt_3

Scope: Sample: Message size limit exceeded

message name receipt	<Rct>
Message Header	<MsgHdr>
Message Identification	<MsgId>ABCDEFGHIJKLMNQRST123456789012345</MsgId>
End of Message Header	</MsgHdr>
Receipt details	<RctDtls>
original message ID	<OrgnMsgId>
Message Identification	<MsgId>ABCDEFGHIJKLMNQRSTUWXYZ</MsgId>
End of Original Message ID	</OrgnMsgId>
RequestHandling	<ReqHdlg>
StatusCode	<StsCd>1003</StsCd>
Description	<Desc>Message size limit exceeded</Desc>
End of Request Handling	</ReqHdlg>
End of Receipt details	</RctDtls>
End message name Receipt	</Rct>

Receipt_4

Scope: Sample: O.k.

message name receipt	<Rct>
Message Header	<MsgHdr>
Message Identification	<MsgId>ABCDEFGHIJKLMNOPQRSTUVWXYZ123456789012345</MsgId>
End of Message Header	</MsgHdr>
Receipt details	<RctDtls>
original message ID	<OrgnlMsgId>
Message Identification	<MsgId>ABCDEFGHIJKLMNOPQRSTUVWXYZ</MsgId>
End of Original Message ID	</OrgnlMsgId>
RequestHandling	<ReqHdlg>
StatusCode	<StsCd>0000</StsCd>
Description	<Desc>O.k.</Desc>
End of Request Handling	</ReqHdlg>
End of Receipt details	</RctDtls>
End message name Receipt	</Rct>

6.3.6 ReturnBroadcast

SSP Proprietary Messages

ReturnBroadcast

Scope: The ReturnBroadcast message is used to return the broadcasts sent to the direct PM participant during the current business day.

The connected request is performed by a GetBroadcast message.

<camt.998.001.xx>

Structure:

Name Proprietary message	<PrtryMsg>
Message Header	<MsgHdr>
Message Identification	<MsgId></MsgId>
End of Message Header	</MsgHdr>
Related	<Rltd>
Reference	<Ref></Ref>
End of Related	</Rltd>
Proprietary Data	<PrtryData>
Proprietary Data type	<Tp>ReturnBroadcast</Tp>
Proprietary Data	<Data>
SSP Proprietary Data	<SspPrtryDt>
choice	xorBizRptOprlErr
BusinessReport	<BizRpt>
Broadcast Report	<BrdRpt>
Broadcast Details	<BrdDtls>
Sender	<Sndr></Sndr>
Receiver Information	<RecvrInf>
Receiver Details	<RcvrDtls>
choice amongst	xorRspnsblCBPtcpt
Responsible Central Bank	<RspnsblCB>
Country Code	<Ctry></Ctry>
End responsible Cental Bank	</RspnsblCB>
Participant BIC	<Ptcpt></Ptcpt>
End choice amongst	/xorRspnsblCBPtcpt
End of Receiver Details	</RcvrDtls>
User Role	<UsrRole></UsrRole>
End of Receiver Information	</RecvrInf>
Broadcast type	<Tp></Tp>
Subject	<Sbjt></Sbjt>
SubjectDetails	<SbjtDtls></SbjtDtls>
DateTime	<DtTm></DtTm>
broadcast status	<Sts></Sts>
Expiration Date	<ExpDt></ExpDt>
End Broadcast Details	</BrdDtls>
End of Broadcast Report	</BrdRpt>
End of BusinessReport	</BizRpt>
OperationalError	<OprlErr>
Error handling	<Err>
Proprietary error code	<Prtry></Prtry>
End error handling	</Err>
Description	<Desc></Desc>
End of Operational Error	</OprlErr>

End choice
End of SSP Proprietary Data
End of Proprietary Data
End of Proprietary Data
End proprietary message

```
| | | | /xorBizRptOprlErr  
| | | | </SspPrtryDt>  
| | | | </Data>  
| | | | </PrtryData>  
| | | | </PrtryMsg>
```

Attributes:

name of attribute	format	short description	description
<PrtryMsg>		Name Proprietary message Mandatory A2A	Validation:
<MsgHdr>		Message Header Mandatory A2A	Set of characteristics specific to the message Message Reference Validation: [1..1]
<MsgId>-</MsgId>	35x	Message Identification Mandatory A2A	Message Identification Validation: [1..1]
</MsgHdr>		End of Message Header Mandatory A2A	Validation: [1..1]
<Rltd>		Related Mandatory A2A	References a previously received message. Validation: [1..1]
<Ref>-</Ref>	35x	Reference Mandatory A2A	Unique and unambiguous reference Message Identification of the initiating Get Message (here Get Broadcast) Validation: [1..1]
</Rltd>		End of Related Mandatory A2A	End of Related Validation: [1..1]
<PrtryData>		Proprietary Data Mandatory A2A	Proprietary Data Validation: [1..1]
<Tp>-</Tp>		Proprietary Data type Mandatory A2A	Proprietary Data type here only ReturnBroadcast is possible Validation: [1..1]
<Data>		Proprietary Data Mandatory	Proprietary data content Validation: [1..1]
<SspPrtryDt>		SSP Proprietary Data Mandatory A2A	Root element for all SSP proprietary data Validation: [1..1]
xorBizRptOpriErr		choice	choice amongst BizRpt und OpriErr Rule description: If BusinessReport is present then OperationalError is not allowed. If BusinessReport is not present, then OperationalError is mandatory.

name of attribute	format	short description	description
		Mandatory A2A	Validation:
<BizRpt>		BusinessReport Mandatory A2A	BusinessReport Validation: [1..1]
<BrdRpt>		Broadcast Report Mandatory A2A	Broadcast Report Validation: [1..n]
<BrdDtls>		Broadcast Details Mandatory A2A	Broadcast Details Validation: [1..1]
<Sndr>-</Sndr>	35x	Sender Mandatory A2A	free format tag Sender values: SSP operator, CB <CC>, System Validation: [1..1]
<RecvrInf>		Receiver Information Optional A2A	Receiver Information: responsible CB, Receiver Participant, User Role free format tag Validation: [0..1] only displayed for CB's
<RcvrDtls>		Receiver Details Optional A2A	Validation: [0..1]
xorRspnsblCBPcpt		choice amongst Mandatory	choice amongst all participants of responsible CB or Participant BIC Validation:
<RspnsblCB>		Responsible Central Bank Mandatory A2A	Responsible Central Bank The CB's country code will be filled in <Ctry>. Validation: [1..1]
<Ctry>-</Ctry>	2!a	Country Code Mandatory A2A	Country Code Code to identify a country, a dependency, or another area of particular geopolitical interest, on the basis of country names obtained from the United Nations (ISO 3166, Alpha-2 code). Validation: [1..1]
</RspnsblCB>		End responsible Cental Bank Mandatory	end responsible Cental Bank Validation:

name of attribute	format	short description	description
		A2A	[1..1]
<Ptcpt>-</Ptcpt>	11x	Participant BIC	free format tag Receiver Participant
		Mandatory	Validation: [1..1]
		A2A	[1..1]
/xorRspnsblCBPtcpt		End choice amongst	end choice amongst all participants of responsible CB or Participant BIC
		Mandatory	Validation:
</RcvrDtIs>		End of Receiver Details	
		Optional	Validation: [0..1]
		A2A	[0..1]
<UsrRole>-</UsrRole>	70x	User Role	free format tag Proprietary Role Following U2A user roles can occur: CUPAYM CULIQU CULIMI CUBAUP CURMAN CUINFO CUGAMA CURGOA CUCOMA CURCOM HAMANA LVMANA ASMANA ASINFO CSMANA CSINFO TAMANA TAINFR CMMANA CMINFO CBMANA CBSDMA CBINFR CBBILM CBBILR CBCUSM CBCUSR CBEVCM CBEVCR BOMANA BOADMIN BOINFO TOINFO
		Optional	Validation: [0..1]
		A2A	[0..1]
</RecvrInf>		End of Receiver Information	End of Receiver Information
		Optional	Validation: [0..1]
		A2A	[0..1]
<Tp>-</Tp>		Broadcast type	Broadcast types:

name of attribute	format	short description	description
			Alert = ALRT used for very important information, directly displayed at receivers side on an additional screen. This information is always captured by CB or SSP. Normal = NORM created in an automatic way by the system in special situations (related to a single message and the related participants) less important information captured by CB or SSP user
		Mandatory A2A	Validation: [1..1]
<Sbjt>	140x	Subject	Subject line of an item of general business information, summarizing the topic and intended destination of the information. Subject
		Mandatory A2A	Validation: [1..1] e.g. NewTarget2Directory, search for respective subject, wildcards are possible
<SbjtDtls>	770x	SubjectDetails	General business information, in unstructured form text
		Mandatory A2A	Validation: [1..1]
<DtTm>		DateTime	A specified date and time. Delivery Date and Time
		Mandatory A2A	Validation: [1..1]
<Sts>-</Sts>		broadcast status	free format tag broadcast status RECV = received READ = read DELI = delivered (only for CB's) Broadcast status
		Mandatory A2A	Validation: [1..1] values for received broadcasts: "received", "read" default value: "received" in case broadcast type = "normal" values for send broadcasts (only for CB available): "delivered"
<ExpDt>-</ExpDt>	ISODate	Expiration Date	Expiration Date
		Mandatory A2A	Validation: [1..1]
</BrdDtls>		End Broadcast Details	End Broadcast Details
		Mandatory A2A	Validation: [1..1]
</BrdRpt>		End of Broadcast Report	End of Broadcast Report
		Mandatory A2A	Validation: [1..n]
</BizRpt>		End of BusinessReport	End of BusinessReport
		Mandatory	Validation:

name of attribute	format	short description	description
		A2A	[1..1]
<OprlErr>		OperationalError	<p>Rule rationale: The message will contain either the information matching the search criteria of the related Get message or an error indication.</p> <p>Rule description: If BusinessReport is present then OperationalError is not allowed. If BusinessReport is not present, then OperationalError is mandatory.</p> <p>Separate Specification see UDFS books regarding error codes</p>
		Mandatory	Validation:
		A2A	[1..1]
<Err>		Error handling	
		Mandatory	Validation:
		A2A	[1..1]
<Prtry>-</Prtry>	4x	Proprietary error code	Specification of the error, in free format.
		Mandatory	Validation:
		A2A	[1..1]
</Err>		End error handling	
		Mandatory	Validation:
		A2A	[1..1]
<Desc>-</Desc>	140x	Description	Specification of the error, in free format.
		Optional	Validation:
		A2A	[0..1]
</OprlErr>		End of Operational Error	End of Operational Error
		Mandatory	Validation:
		A2A	[1..1]
/xorBizRptOprlErr		End choice	Rule description: If BusinessReport is present then OperationalError is not allowed. If BusinessReport is not present, then OperationalError is mandatory.
		Mandatory	Validation:
		A2A	
</SspPrtryDt>		End of SSP Proprietary Data	End of Root element for all SSP proprietary data
		Mandatory	Validation:
		A2A	[1..1]
</Data>		End of Proprietary Data	
		Mandatory	Validation:
			[1..1]
</PrtryData>		End of Proprietary Data	End of Proprietary Data
		Mandatory	Validation:
		A2A	[1..1]
</PrtryMsg>		End proprietary message	
		Mandatory	Validation:
		A2A	

Error Codes:

ReturnBroadcast_1

Scope: Return Broadcast with all Broadcast details (for CB), for all participants for the CB

Name Proprietary message	<PrtryMsg>
Message Header	<MsgHdr>
Message Identification	<MsgId>ABC123</MsgId>
End of Message Header	</MsgHdr>
Related	<Rltd>
Reference	<Ref>GHIJKLMN12345</Ref>
End of Related	</Rltd>
Proprietary Data	<PrtryData>
Proprietary Data type	<Tp>ReturnBroadcast</Tp>
Proprietary Data	<Data>
SSP Proprietary Data	<SspPrtryDt>
BusinessReport	<BizRpt>
Broadcast Report	<BrdRpt>
Broadcast Details	<BrdDtls>
Sender	<Sndr>System</Sndr>
Receiver Information	<RecvrInf>
Receiver Details	<RcvrDtls>
Responsible Central Bank	<RspnsblCB>
Country Code	<Ctry>DE</Ctry>
End responsible Cental Bank	</RspnsblCB>
End of Receiver Details	</RcvrDtls>
End of Receiver Information	</RecvrInf>
Broadcast type	<Tp>NORM</Tp>
Subject	<Sbjt>Payment PM / HAM failed</Sbjt>
SubjectDetails	<SbjtDtls>XXXXXXXXXXXXXXXX</SbjtDtls>
DateTime	<DtTm>2002-07-21T08:35:30</DtTm>
broadcast status	<Sts>RECV</Sts>
Expiration Date	<ExpDt>2007-05-04</ExpDt>
End Broadcast Details	</BrdDtls>
End of Broadcast Report	</BrdRpt>
End of BusinessReport	</BizRpt>
End of SSP Proprietary Data	</SspPrtryDt>
End of Proprietary Data	</Data>
End of Proprietary Data	</PrtryData>
End proprietary message	</PrtryMsg>

ReturnBroadcast_2

Scope: Return Broadcast with Broadcast details Participant (non CB) with the role of liquidity manager

Name Proprietary message	<PrtryMsg>
Message Header	<MsgHdr>
Message Identification	<MsgId>ABC123</MsgId>
End of Message Header	</MsgHdr>
Related	<Rltd>
Reference	<Ref>GHIJKLMN12345</Ref>
End of Related	</Rltd>
Proprietary Data	<PrtryData>
Proprietary Data type	<Tp>ReturnBroadcast</Tp>
Proprietary Data	<Data>
SSP Proprietary Data	<SspPrtryDt>
BusinessReport	<BizRpt>
Broadcast Report	<BrdRpt>
Broadcast Details	<BrdDtls>
Sender	<Sndr>System</Sndr>
Receiver Information	<RecvrInf>
Receiver Details	<RcvrDtls>
Participant BIC	<Ptcpt>DRESDEFF</Ptcpt>
End of Receiver Details	</RcvrDtls>
User Role	<UsrRole>CUPAYM</UsrRole>
End of Receiver Information	</RecvrInf>
Broadcast type	<Tp>NORM</Tp>
Subject	<Sbjt>Payment PM / HAM failed</Sbjt>
SubjectDetails	<SbjtDtls>Payment from PM to a CB's customer in HAM that fails in HAM.</SbjtDtls>
DateTime	<DtTm>2002-07-21T08:35:30</DtTm>
broadcast status	<Sts>RECV</Sts>
Expiration Date	<ExpDt>2007-05-04</ExpDt>
End Broadcast Details	</BrdDtls>
End of Broadcast Report	</BrdRpt>
End of BusinessReport	</BizRpt>
End of SSP Proprietary Data	</SspPrtryDt>
End of Proprietary Data	</Data>
End of Proprietary Data	</PrtryData>
End proprietary message	</PrtryMsg>

6.3.7 ReturnSystemTime

SSP Proprietary Messages

ReturnSystemTime

Scope: The ReturnSystemTime message is used to return the system time of the SSP (Actual system time of the SSP server). It is used to confirm that the connection from the SSP server is ok.

The connected request is performed by a GetSystemTime message.

Related modules: PM, HAM, RMM, SDM, SFM and PHA

<camt.998.001.xx>

Structure:

Name Proprietary message	<PrtryMsg>
Message Header	<MsgHdr>
Message Identification	<MsgId></MsgId>
End of Message Header	</MsgHdr>
Related	<Rltd>
Reference	<Ref></Ref>
End of Related	</Rltd>
Proprietary Data	<PrtryData>
Proprietary Data type	<Tp>ReturnSystemTime</Tp>
Proprietary Data	<Data>
SSP Proprietary Data	<SspPrtryDt>
choice	xorBizRptOprlErr
BusinessReport	<BizRpt>
SystemTimeReport	<SysTmRpt>
SystemTimeDetails	<SysTmDtls>
DateTime	<SysTm></SysTm>
End of SystemTimeDetails	</SysTmDtls>
End of SystemTimeReport	</SysTmRpt>
End of BusinessReport	</BizRpt>
OperationalError	<OprlErr>
Error handling	<Err>
Proprietary error code	<Prtry></Prtry>
End error handling	</Err>
Description	<Desc></Desc>
End of Operational Error	</OprlErr>
End choice	/xorBizRptOprlErr
End of SSP Proprietary Data	</SspPrtryDt>
End of Proprietary Data	</Data>
End of Proprietary Data	</PrtryData>
End proprietary message	</PrtryMsg>

Attributes:

name of attribute	format	short description	description
<PrtryMsg>		Name Proprietary message Mandatory A2A	Validation:
<MsgHdr>		Message Header Mandatory A2A	Set of characteristics specific to the message Message Reference Validation: [1..1]
<MsgId>-</MsgId>	35x	Message Identification Mandatory A2A	Message Identification Validation: [1..1]
</MsgHdr>		End of Message Header Mandatory A2A	Validation: [1..1]
<Rltd>		Related Mandatory A2A	References a previously received message. Validation: [1..1]
<Ref>-</Ref>	35x	Reference Mandatory A2A	Unique and unambiguous reference Validation: [1..1]
</Rltd>		End of Related Mandatory A2A	End of Related Validation: [1..1]
<PrtryData>		Proprietary Data Mandatory A2A	Proprietary Data Validation: [1..1]
<Tp>-</Tp>		Proprietary Data type Mandatory A2A	Proprietary Data type Validation: [1..1]
<Data>		Proprietary Data Mandatory	Proprietary data content Validation: [1..1]
<SspPrtryDt>		SSP Proprietary Data Mandatory A2A	SSP Proprietary Data Validation: [1..1]
xorBizRptOprlErr		choice Mandatory A2A	choice amongst BizRpt und OprlErr Rule description: If BusinessReport is present then OperationalError is not allowed. If BusinessReport is not present, then OperationalError is mandatory. Validation:

name of attribute	format	short description	description
<BizRpt>		BusinessReport	BusinessReport
		Mandatory	Validation:
		A2A	[1..1]
<SysTmRpt>		SystemTimeReport	SystemTimeReport
		Mandatory	Validation:
		A2A	[1..1]
<SysTmDtls>		SystemTimeDetails	SystemTimeDetails
		Mandatory	Validation:
		A2A	[1..1]
<SysTm></SysTm>		DateTime	DateTime
		Mandatory	Validation:
		A2A	[1..1]
</SysTmDtls>		End of SystemTimeDetails	end of SystemTimeDetails
		Mandatory	Validation:
		A2A	[1..1]
</SysTmRpt>		End of SystemTimeReport	end of SystemTimeReport
		Mandatory	Validation:
		A2A	[1..1]
</BizRpt>		End of BusinessReport	
		Mandatory	Validation:
		A2A	[1..1]
<OprlErr>		OperationalError	Indicates an operational error
			Rule description: If BusinessReport is present then OperationalError is not allowed. If BusinessReport is not present, then OperationalError is mandatory.
		Mandatory	Validation:
		A2A	[1..1]
<Err>		Error handling	
		Mandatory	Validation:
		A2A	[1..1]
<Prtry></Prtry>	4x	Proprietary error code	Specification of the error, in free format.
		Mandatory	Validation:
		A2A	[1..1]
</Err>		End error handling	
		Mandatory	Validation:
		A2A	[1..1]
<Desc></Desc>	140x	Description	Specification of the error, in free format.
		Optional	Validation:
		A2A	[0..1]

name of attribute	format	short description	description
</OprlErr>		End of Operational Error	End of Operational Error
		Mandatory	Validation:
		A2A	[1..1]
/xorBizRptOprlErr		End choice	Rule description: If BusinessReport is present then OperationalError is not allowed. If BusinessReport is not present, then OperationalError is mandatory.
		Mandatory	Validation:
		A2A	
</SspPrtryDt>		End of SSP Proprietary Data	End of Root element for all SSP proprietary data
		Mandatory	Validation:
		A2A	[1..1]
</Data>		End of Proprietary Data	
		Mandatory	Validation:
			[1..1]
</PrtryData>		End of Proprietary Data	End of Proprietary Data
		Mandatory	Validation:
		A2A	[1..1]
</PrtryMsg>		End proprietary message	
		Mandatory	Validation:
		A2A	

Error Codes:

ReturnSystemTime_1

Scope: Sample:

Name Proprietary message	<PrtryMsg>
Message Header	<MsgHdr>
Message Identification	<MsgId>ABC123</MsgId>
End of Message Header	</MsgHdr>
Related	<Rltd>
Reference	<Ref>ABCDEFGHIJKLMNOPQRSTUVWXYZ123456789</Ref>
End of Related	</Rltd>
Proprietary Data	<PrtryData>
Proprietary Data type	<Tp>ReturnSystemTime</Tp>
Proprietary Data	<Data>
SSP Proprietary Data	<SspPrtryDt>
BusinessReport	<BizRpt>
SystemTimeReport	<SysTmRpt>
SystemTimeDetails	<SysTmDtls>
DateTime	<SysTm>2007-01-01T12:00:00</SysTm>
End of SystemTimeDetails	</SysTmDtls>
End of SystemTimeReport	</SysTmRpt>
End of BusinessReport	</BizRpt>
End of SSP Proprietary Data	</SspPrtryDt>
End of Proprietary Data	</Data>
End of Proprietary Data	</PrtryData>
End proprietary message	</PrtryMsg>

6.3.8 ReturnTask

SSP Proprietary Messages

ReturnTask

Scope: The ReturnTask message is used to return the information about the tasks listed in the task queue. The ReturnTask messages is sent by the SSP server to report the current status of the elements in the task queue of a single SSP module.

The connected request is performed by a GetTask message.

Usage

Related module: HAM, PM, RMM, SDM, SFM and PHA

The message contains the following information:

- Identification of the task
- Entry date/time
- Current status of the task
- Error code and description (when the current status is (rejected)
- Last User
- Modification date (only used for SDM)
- Message body of the request that initiated the task or Remark: This is a reconstruction based on the available parameters and not the original request sent by the customer client.

The captured task is returned as separate XML document together with the payload. The payload is a queue of separate XML documents. Only one Application Header is used.

Illustration of the payload:

AppHdr ReturnTask Message ReturnTask Message etc.

Technical Examples

Both U2A users and A2A applications requested modifications. The send requests to the SSP which are stored in the task queue. An A2A application queries the task queue to get a report on all tasks (which have been generated by A2A) that have been executed during the day.

<camt.998.001.xx>

Structure:

Name Proprietary message	<PrtryMsg>
Message Header	<MsgHdr>
Message Identification	<MsgId></MsgId>
End of Message Header	</MsgHdr>
Related	<Rltd>
Reference	<Ref></Ref>
End of Related	</Rltd>
Proprietary Data	<PrtryData>
Proprietary Data type	<Tp>ReturnTask</Tp>
Proprietary Data	<Data>
SSP Proprietary Data	<SspPrtryDt>
choice	xorBizRptOprlErr
BusinessReport	<BizRpt>
Task report	<TskRpt>
Task Reference	<TskRef>
Additional Reference	<RltdRef>
Reference	<Ref></Ref>
End of Additional Reference	</RltdRef>
End of TaskReference	</TskRef>
Task details	<Tsk>
Task Entry	<TskNtry>
Entry Date / Time	<NtryDt>
DateTime	<DtTm></DtTm>
End of Entry Date / Time	</NtryDt>
Requestor	<Reqr>
BIC	<BIC></BIC>

End Requestor	</Req>
End task entry	</TskNtry>
task queue status	<TskQSts>
TaskStatus	<TskSts></TskSts>
Task status reason	<TskStsRsn>
Error handling	<Err>
Proprietary error code	<Prtry></Prtry>
End error handling	</Err>
Description	<Desc></Desc>
End task status reason	</TskStsRsn>
Last user DN	<LstUsr></LstUsr>
Task status date	<TskStsDt>
Date	<Dt></Dt>
End task status date	</TskStsDt>
End task queue status	</TskQSts>
processing instruction	any
End task details	</Tsk>
End task report	</TskRpt>
End of BusinessReport	</BizRpt>
OperationalError	<OprlErr>
Error handling	<Err>
Proprietary error code	<Prtry></Prtry>
End error handling	</Err>
Description	<Desc></Desc>
End of Operational Error	</OprlErr>
End choice	/xorBizRptOprlErr
End of SSP Proprietary Data	</SspPrtryDt>
End of Proprietary Data	</Data>
End of Proprietary Data	</PrtryData>
End proprietary message	</PrtryMsg>

Attributes:

name of attribute	format	short description	description
<PrtryMsg>		Name Proprietary message Mandatory A2A	Validation:
<MsgHdr>		Message Header Mandatory A2A	Set of characteristics specific to the message Validation: [1..1]
<MsgId>-</MsgId>	35x	Message Identification Mandatory A2A	Message Identification Message Reference Validation: [1..1]
</MsgHdr>		End of Message Header Mandatory A2A	Validation: [1..1]
<Rltd>		Related Mandatory A2A	References a previously received message. Validation: [1..1]
<Ref>-</Ref>	35x	Reference Mandatory A2A	Unique and unambiguous reference Message Identification of the initiating Get Message (here GetTask) Validation: [1..1]
</Rltd>		End of Related Mandatory A2A	End of Related Validation: [1..1]
<PrtryData>		Proprietary Data Mandatory A2A	Proprietary Data Validation: [1..1]
<Tp>-</Tp>		Proprietary Data type Mandatory A2A	Proprietary Data type Validation: [1..1]
<Data>		Proprietary Data Mandatory	Proprietary data content Validation: [1..1]
<SspPrtryDt>		SSP Proprietary Data Mandatory A2A	SSP Proprietary Data Validation: [1..1]
xorBizRptOpriErr		choice Mandatory	choice amongst BizRpt und OpriErr Validation: Rule description: If BusinessReport is present then OperationalError is not allowed. If BusinessReport is not present, then OperationalError is mandatory.

name of attribute	format	short description	description
			[1..1]
<BizRpt>		BusinessReport	BusinessReport
		Mandatory	Validation:
		A2A	[1..1]
<TskRpt>		Task report	
		Mandatory	Validation:
		A2A	[1..n]
<TskRef>		Task Reference	Task Reference
		Mandatory	Validation:
		A2A	[1..1] Unique and unambiguous identification of the task
<RltdRef>		Additional Reference	Additional Reference
		Mandatory	Validation:
		A2A	[1..1] identification of the task that has been returned to the initiator with the Receipt or related return message
<Ref>-</Ref>	35x	Reference	Unique and unambiguous reference
		Mandatory	Validation:
		A2A	[1..1]
</RltdRef>		End of Additional Reference	End of Additional Reference
		Mandatory	Validation:
		A2A	[1..1]
</TskRef>		End of TaskReference	End of TaskReference
		Mandatory	Validation:
		A2A	[1..1]
<Tsk>		Task details	
		Mandatory	Validation:
		A2A	[1..1]
<TskNtry>		Task Entry	fixed parameters of a task
		Mandatory	Validation:
		A2A	[1..1]
<NtryDt>		Entry Date / Time	Date and time at which an entry is posted to an account on the account servicer's books.
		Optional	Validation:
		A2A	[0..1]
<DtTm>		DateTime	A specified date and time.
		Mandatory	Validation:
		A2A	[1..1]
</NtryDt>		End of Entry Date / Time	
		Optional	Validation:
		A2A	[0..1]
<Req>		Requestor	Requestor used on behalf of third parties This element is only returned by PM to CB users.

name of attribute	format	short description	description
		Optional	It reports the BIC of the customer who is affected by the task. Different customers will be mentioned in case the CB ordered credit line changes for several accounts and did not limit the task query to a single account holder. Validation: [0..1]
<BIC>-</BIC>	11x	BIC	BICIdentifier Code allocated to financial institutions by the Registration Authority, under an international identification scheme, as described in the latest version of the standard ISO 9362 "Banking - Banking telecommunication messages - Bank Identifier Codes". SWIFT is the Registration Authority for ISO 9362. Validation: [1..1]
</Req>		End Requestor	End Requestor
		Optional	Validation: [0..1]
</TskNtry>		End task entry	
		Mandatory	Validation: [1..1]
		A2A	
<TskQSts>		task queue status	changing parameters of a task
		Mandatory	Validation: [1..1]
		A2A	
<TskSts>-</TskSts>		TaskStatus	current status of the task - toConfirm (the task has to be confirmed by a second user [in U2A mode] and will not be processed by then) - waiting (the task can be processed) - pending (only relevant for PM - it was tried to process the task) - processing (the task is being processed at the moment) - partiallyPending (only relevant for PM - the order is partially processed, the task will be updated and further processed, if the pre-conditions for the status (e.g. liquidity increase) are changed.) - revoked (the task has been revoked by a user) - rejected (an error was detected) - completed (the task was processed successfully) For further details refer to chapter 2.6.2. Validation: [1..1] current status of the task
		Mandatory	
		A2A	
<TskStsRsn>		Task status reason	Task status reason used in case of errors (if task is rejected) or in case the task is only partially processed Validation: [0..1]
		Optional	
		A2A	
<Err>		Error handling	An error code is only reported if the task status is "rejected". Validation: [0..1]
		Optional	
		A2A	
<Prtry>-</Prtry>	4x	Proprietary error code	Specification of the error, in free format. Validation:
		Mandatory	

name of attribute	format	short description	description
			[1..1]
</Err>		End error handling Optional	Validation: [0..1]
<Desc>-</Desc>	140x	Description Optional A2A	In case of an error the error text is reported. In case of a reservation order is only partially executed the amount of the pending increase of reservation value is reported. Validation: [0..1]
</TskStsRsn>		End task status reason Optional A2A	Validation: [0..1]
<LstUsr>-</LstUsr>	100x	Last user DN Mandatory A2A	free format tag Validation: [1..1]
<TskStsDt>		Task status date Optional A2A	Validation: [0..1]
<Dt>-</Dt>	ISODate	Date Mandatory A2A	Date within a particular calendar year represented by YYYY-MM-DD (ISO 8601). Validation: [1..1]Modification date only used for Static Data
</TskStsDt>		End task status date Optional A2A	Validation: [0..1]
</TskQSts>		End task queue status Mandatory A2A	Validation: [1..1]
any		processing instruction Mandatory	message body (business payload) of the request, that initiated the task e.g. report of a ModifyLimit and ModifyTransaction task from PM or other SSP modules. Validation: [1..1]in case of an initiated U2A "payment modification", the elements of the LongBizId (TRN, amount, value date, message type, sender, receiver and potential related reference) will be displayed.
</Tsk>		End task details Mandatory A2A	Validation: [1..1]
</TskRpt>		End task report Mandatory A2A	Validation: [1..n]
</BizRpt>		End of BusinessReport Mandatory	End of BusinessReport Validation:

name of attribute	format	short description	description
		A2A	[1..1]
<OprlErr>		OperationalError	Rule rationale: The message will contain either the information matching the search criteria of the related Get message or an error indication. Rule description: If BusinessReport is present then OperationalError is not allowed. If BusinessReport is not present, then OperationalError is mandatory. Separate Specification see UDFS books regarding error codes
		Optional	Validation:
		A2A	[0..1] technical error report
<Err>		Error handling	
		Mandatory	Validation:
		A2A	[1..1]
<Prtry>-</Prtry>	4x	Proprietary error code	Specification of the error, in free format.
		Mandatory	Validation:
		A2A	[1..1]
</Err>		End error handling	
		Mandatory	Validation:
		A2A	[1..1]
<Desc>-</Desc>	140x	Description	Specification of the error, in free format.
		Optional	Validation:
		A2A	[0..1]
</OprlErr>		End of Operational Error	End of Operational Error
		Optional	Validation:
		A2A	[0..1]
/xorBizRptOprlErr		End choice	Rule description: If BusinessReport is present then OperationalError is not allowed. If BusinessReport is not present, then OperationalError is mandatory.
		Mandatory	Validation:
			[1..1]
</SspPrtryDt>		End of SSP Proprietary Data	End of Root element for all SSP proprietary data
		Mandatory	Validation:
		A2A	[1..1]
</Data>		End of Proprietary Data	
		Mandatory	Validation:
			[1..1]
</PrtryData>		End of Proprietary Data	End of Proprietary Data
		Mandatory	Validation:
		A2A	[1..1]
</PrtryMsg>		End proprietary message	
		Mandatory	Validation:
		A2A	

Error Codes:

ReturnTask_1

Scope: Report of rejected task (Modify Limit)

Please have a look for details of the complete ReturnTask structure within the general chapter of book 4.

Name Proprietary message	<PrtryMsg>
Message Header	<MsgHdr>
Message Identification	<MsgId>ABC123</MsgId>
End of Message Header	</MsgHdr>
Related	<Rltd>
Reference	<Ref>ABC124</Ref>
End of Related	</Rltd>
Proprietary Data	<PrtryData>
Proprietary Data type	<Tp>ReturnTask</Tp>
Proprietary Data	<Data>
SSP Proprietary Data	<SspPrtryDt>
BusinessReport	<BizRpt>
Task report	<TskRpt>
Task Reference	<TskRef>
Additional Reference	<RltdRef>
Reference	<Ref>Task1</Ref>
End of Additional Reference	</RltdRef>
End of TaskReference	</TskRef>
Task details	<Tsk>
Task Entry	<TskNtry>
Entry Date / Time	<NtryDt>
DateTime	<DtTm>2008-07-21T08:35:30</DtTm>
End of Entry Date / Time	</NtryDt>
End task entry	</TskNtry>
task queue status	<TskQSts>
TaskStatus	<TskSts>rejected</TskSts>
Task status reason	<TskStsRsn>
Error handling	<Err>
Proprietary error code	<Prtry>2862</Prtry>
End error handling	</Err>
Description	<Desc>Request out of cut-off or time</Desc>
End task status reason	</TskStsRsn>
Last user DN	<LstUsr>cn=Josef,ou=tssp,ou=markdeff,o=swift</LstUsr>
End task queue status	</TskQSts>
processing instruction	<Document xmlns="urn:swift:xsd:\$camt.011.001.03">payload of ModifyLimit</Document>
End task details	</Tsk>
End task report	</TskRpt>
End of BusinessReport	</BizRpt>
End of SSP Proprietary Data	</SspPrtryDt>
End of Proprietary Data	</Data>
End of Proprietary Data	</PrtryData>
End proprietary message	</PrtryMsg>

ReturnTask_2

Scope: Report of completed task
(ModifyTransaction)

Please have a look for details of the complete ReturnTask structure within the general chapter of book 4.

Name Proprietary message	<PrtryMsg>
Message Header	<MsgHdr>
Message Identification	<MsgId>ABC123</MsgId>
End of Message Header	</MsgHdr>
Related	<Rltd>
Message Identification	<Ref>ABC124</Ref>
End of Related	</Rltd>
Proprietary Data	<PrtryData>
Proprietary Data type	<Tp>ReturnTask</Tp>
Proprietary Data	<Data>
SSP Proprietary Data	<SspPrtryDt>
BusinessReport	<BizRpt>
Task report	<TskRpt>
Task Reference	<TskRef>
Additional Reference	<RltdRef>
Message Identification	<Ref>Task2</Ref>
End of Additional Reference	</RltdRef>
End of TaskReference	</TskRef>
Task details	<Tsk>
Task Entry	<TskNtry>
Entry Date / Time	<NtryDt>
DateTime	<DtTm>2008-07-21T08:35:30</DtTm>
End of Entry Date / Time	</NtryDt>
End task entry	</TskNtry>
task queue status	<TskQSts>
TaskStatus	<TskSts>completed</TskSts>
Last user DN	<LstUsr>cn=Josef,ou=tssp,ou=markdeff,o=swift</LstUsr>
End task queue status	</TskQSts>
processing instruction	<Document xmlns="urn:swift:xsd:\$camt.007.001.03">payload of ModifyTransaction</Document>
End task details	</Tsk>
End task report	</TskRpt>
End of BusinessReport	</BizRpt>
End of SSP Proprietary Data	</SspPrtryDt>
End of Proprietary Data	</Data>
End of Proprietary Data	</PrtryData>
End proprietary message	</PrtryMsg>

6. 4 XML messages related to PM

6. 4. 1 BackupPayment

Cash Management Standard

BackupPayment_PM

Scope: The BackupPayment message (for CI customer) is used to create backup liquidity redistribution and contingency payments in case the direct PM participant is temporarily not able to send SWIFTNet FIN messages. Backup liquidity redistribution payments can be created in favour of other direct PM participants. Contingency payments can be created in favour of CLS and EURO1 (EURO1 collateral account and EURO1 pre-settlement account).

The BackupPayment message can be sent by the application of a direct PM participant after the functionality was released by the national help desk of his related CB.

The BackupPayment message is replied by a Receipt message.
Non-Repudiation of Emission (NRE) is supported.

<camt.023.001.xx>

Structure:

Message name for BackupPayment	<BckpPmt>
Message Header	<MsgHdr>
Message Identification	<MsgId></MsgId>
End of Message Header	</MsgHdr>
Original Message ID	<OrgnlMsgId>
Message Identification	<MsgId></MsgId>
End of Original Message ID	</OrgnlMsgId>
Payment Instruction Information	<InstrInf>
RequestedExecutionDateTime	<ReqdExctnDtTm></ReqdExctnDtTm>
Payment Type	<PmtTp>
Payment type code	<Cd></Cd>
End Payment Type	</PmtTp>
End Payment Instruction Information	</InstrInf>
Transferred Amount	<TrfdAmt>
Amount without currency	<AmtWthtCcy></AmtWthtCcy>
End of Transferred Amount	</TrfdAmt>
Creditor	<Cdtr>
Member Identification	<Mmbld>
BICFIIdentifier	<BICFI></BICFI>
End of Member Identification	</Mmbld>
End of Creditor	</Cdtr>
CreditorAgent	<CdtrAgt>
Member Identification	<Mmbld>
BICFIIdentifier	<BICFI></BICFI>
End of Member Identification	</Mmbld>
End of Creditor Agent	</CdtrAgt>
Debtor Agent	<DbtrAgt>
Member Identification	<Mmbld>
BICFIIdentifier	<BICFI></BICFI>
End of Member Identification	</Mmbld>
End of Debtor Agent	</DbtrAgt>
End of Message name for BackupPayment	</BckpPmt>

Attributes:

name of attribute	format	short description	description
<BckpPmt>		Message name for BackupPayment Mandatory A2A	Message name for BackupPayment Validation:
<MsgHdr>		Message Header Mandatory A2A	Set of characteristics specific to the message Validation: [1..1]
<MsgId>-</MsgId>	16x	Message Identification Mandatory A2A	String of characters that uniquely identifies a message Validation: [1..1]
</MsgHdr>		End of Message Header Mandatory A2A	Validation: [1..1]
<OrgnlMsgId>		Original Message ID Optional A2A	Additional Payment Reference Validation: [0..1] Only to be used in case of backup contingency payments to CLS or EURO1.
<MsgId>-</MsgId>	16x	Message Identification Mandatory A2A	String of characters that uniquely identifies a message represents F21_RELATED_REF Validation: [1..1]
</OrgnlMsgId>		End of Original Message ID Optional A2A	End of Original Message ID Validation: [0..1]
<InstrInf>		Payment Instruction Information Optional A2A	Payment Instruction Information represents F72 Sender to Receiver Information Validation: [0..1]
<ReqdExctnDtTm>		RequestedExecutionDateT ime Mandatory A2A	RequestedExecutionDateTime ISODateTime needed to fill CLS TIME_INDICATION Validation: *****[1..1] differs from the cash management standard only used in BackupPayment CLS, only time "08:35:30" is necessary for functional requirements, the date within the ISODateTime must indicate the date of current SSP business day
<PmtTp>		Payment Type Mandatory A2A	Payment Type Validation: *****[1..1]
<Cd>-</Cd>	PaymentTyp e3Code	Payment type code	Payment type code SSP restricted code list: CLS needed to fill CLS TIME_INDICATION

name of attribute	format	short description	description
		Mandatory A2A	Validation: [1..1] only used for BackupPayment CLS
</PmtTp>		End Payment Type Mandatory A2A	Validation: [1..1]
</InstrInf>		End Payment Instruction Information Optional A2A	End Payment Instruction Information Validation: [0..1]
<TrfdAmt>		Transferred Amount Mandatory A2A	The amount may be defined with or without the currency. <AmtWthCcy> CurrencyAndAmount <AmtWthCcy> ImpliedCurrencyAndAmount Validation: [1..1] in PM only <AmtWthCcy> is used. field must be followed by <Cdtr>
<AmtWthCcy>- </AmtWthCcy>	18n	Amount without currency Mandatory A2A	Number of monetary units specified in a currency where the unit of currency is implied by the context. totalDigits = 18 fractionDigits = 5 represents F32_AMOUNT Validation: [1..1] in PM only 2 fraction digits are possible value restriction: maximum value 999.999.999.999,99 0,00 value is not allowed
</TrfdAmt>		End of Transferred Amount Mandatory A2A	Validation: [1..1]
<Cdtr>		Creditor Mandatory A2A	Provides details about a system and about a member of a system. represents F58_BIC Validation: [1..1] only used in Backup Payment CLS, SSP and EURO1 EURO1 pre-settlement account = fixed with EBAPFRPPPSA (EBA Clearing BIC for prefund participants deduced from SSP-Parameters) not changeable EURO1 collateral account= fixed with EBAPFRPPCOL (EBA Clearing-BIC deduced from SSP-Parameters) not changeable <SysId> not used in PM The Creditor BIC must be different from the Debtor BIC
<Mmbld>		Member Identification Mandatory A2A	Unique and unambiguous identification of a member within a system, assigned using the member identification scheme of the system Validation: [1..1] in PM only BICFI is used
<BICFI>-</BICFI>	4!a2!a2!c3!c	BICFIIdentifier Mandatory A2A	BICFIIdentifier represents F58_BIC Validation: [1..1] Field 58 / <Cdtr> must be a valid BIC according BIC directory. BackupPayment one Direct PM Participant Field 58 /<Cdtr> must be a valid BIC according participant table

name of attribute	format	short description	description
			and must have an RTGS account.
</Mmbld>		End of Member Identification Mandatory A2A	Validation: [1..1]
</Cdtr>		End of Creditor Mandatory A2A	Validation: [1..1]
<CdtrAgt>		CreditorAgent Optional A2A	Final Agent represents F57_BIC Validation: [0..1] F57_BIC only used with F57_BIC : CLS BackupPayment = fixed with CLSBUS33XXX (CLS Clearing BIC deducted from SSP-Parameters) not changeable but optional in this request since the order type is detected by <PmtTp>CLS</PmtTp>! <Sysld> not used in PM
<Mmbld>		Member Identification Mandatory A2A	Unique and unambiguous identification of a member within a system, assigned using the member identification scheme of the system Validation: [1..1] in PM only BICFI is used
<BICFI>-</BICFI>	4!a2!a2!c3!c	BICFIIdentifier Mandatory A2A	BICFIIdentifier represents F57_BIC Validation: [1..1] Field 57 / <FnlAgt> must be a valid BIC according BIC directory.
</Mmbld>		End of Member Identification Mandatory A2A	Validation: [1..1]
</CdtrAgt>		End of Creditor Agent Optional A2A	End of Creditor Agent Validation: [0..1]
<DbtrAgt>		Debtor Agent Optional A2A	Debtor Agent in SSP only <Mmbld> with BICFI possible represents F52_BIC Validation: [0..1] Ordering / Instructing Institution in Backup Payment CLS, EURO1 (preallocated with the instructing institution but changeable) <Sysld> not used in PM
<Mmbld>		Member Identification Mandatory A2A	Unique and unambiguous identification of a member within a system, assigned using the member identification scheme of the system Validation: [1..1] in PM only BICFI is used
<BICFI>-</BICFI>	4!a2!a2!c3!c	BICFIIdentifier	BICFIIdentifier represents F52 BIC

name of attribute	format	short description	description
		Mandatory A2A	Validation: [1..1] Field 52 / <FrstAgt> must be a valid BIC according BIC directory.
</Mmbld>		End of Member Identification Mandatory A2A	Validation: [1..1]
</DbtrAgt>		End of Debtor Agent Optional A2A	End of Debtor Agent Validation: [0..1]
</BckpPmt>		End of Messagename for BackupPayment Mandatory A2A	Validation:

Error Codes:

Order	Error code				Error Text / Validation/ Remark
	SSP	Y-copy	V-shape	XML	
1	X00			0000	Error Text: O.k. Validation: Confirmation, that a task is stored in the task queue. A related reference for the subsequent processing (e.g. confirmation) of the task is returned. Remark: Receipt (status code)
2	X44			1404	Error Text: If "non repudiation of emission" is mandatory, the NRE indicator flag has to be present Validation: If non-repudiaton processing is mandatory, the tag <SwInt:NRIndicator>TRUE</SwInt:NRIndicator> has to be present.. Remark: checked by ICM/ Receipt
3	X41			1401	Error Text: No permission. RBAC User role(s) are not sufficient. Validation: RBAC role name "APPLICATE", "APPLICSTE" or "APPLICBTE" are required Remark: checked by ICM/ Receipt
4	871	D1	DT01	2871	Error Text: Backup payment is not allowed / Value date in past not allowed Validation: The National Help Desk has to activate the backup functionality in the ICM for the PM participant. Remark: checked by ICM/ Receipt
5	P96	T3		P126	Error Text: Date is not the current SSP business day Validation: ReqdExctnDtTm: date within the ISODateTime must indicate the date of current SSP business day Remark: checked by ICM / Receipt
6	P60			P060	Error Text: Only valid BICs are allowed. Validation: If <PmtTp> is filled with CLS, the CLS Clearing BIC has to be filled in <FnlAgt><Mmbld><BIC> Remark: checked by ICM / Receipt
7	867	C7	XI00	2867	Error Text: BIC debtor and creditor must be different Validation: Cdtr/Mmbld/BIC (profile credit institution) value must not indicate the credit institution itself Remark: checked by ICM / Receipt
8	869			2869	Error Text: Backup to TARGET1 is no longer supported. Validation: FinalAgent may only be filled with BIC of CLS. There is no longer a non-migrated central bank that could be indicated. Remark: checked by ICM / Receipt
9	X40			1400	Error Text: BIC must indicate a SSP participant Validation: BIC must indicate a SSP Participant Remark: checked by ICM/ Receipt
10	P94			P124	Error Text: Requested time must be later than opening time of SSP Validation: The <ReqdExctnDtTm> /CLSTIME cannot be earlier than the opening time of SSP (Start of Day Trade). Remark: checked by ICM / Receipt
11	P85			P115	Error Text: Requested time must be before closing time of SSP Validation: The <ReqdExctnDtTm> / CLSTime cannot be later than the closing time of SSP (Cut-off-Bank-to-Bank). Remark: checked by ICM / Receipt
12	P62			P062	Error Text: BIC must be valid and have an RTGS account.

Order	Error code				Error Text / Validation/ Remark
	SSP	Y-copy	V-shape	XML	
					Validation: BackupPayment one Direct PM Participant Field 58 /<Cdtr> must be a valid BIC according participant table and must have an RTGS account with Account Type 'Normal', 'CB' or 'CB Customer Liquidity Bridge'. Only for backup payments to direct PM participant Remark: checked by PM / TaskQueue
13	894	K4		2894	Error Text: Function is not allowed in the current business day phase Validation: SSP is open Remark: TaskQueue / checked by PM
14	866	C6	AC06	2866	Error Text: Exclusion of participant Validation: If requestor is direct participant or ancillary system or GoA manager and this requestor is excluded, no change of data is allowed Remark: TaskQueue / checked by PM
15	862	C2	TM01	2862	Error Text: Request out of cut-off time Validation: Request has to be within the SSP opening time Remark: TaskQueue / checked by PM
16	P62			P062	Error Text: BIC must be valid and have an RTGS account. Validation: Cdtr/Mmbld/BIC must indicate a SSP Participant. Exception: if the BackupPayment is a CLS BackupPayment, this check will not be executed. Remark: checked by PM/ TaskQueue
17	P60			P060	Error Text: Only valid BICs are allowed. Validation: If used field 57 / <FnlAgt> must be a valid BIC according BIC directory. Remark: TaskQueue / checked by PM
18	862	C2	TM01	2862	Error Text: Request out of cut-off time Validation: Possibility to use this function during the current phase of business day. Remark: checked by PM / TaskQueue
19	P60			P060	Error Text: Only valid BICs are allowed. Validation: If used field 52 / <FrstAgt> must be a valid BIC according BIC directory. Remark: TaskQueue / checked by PM
21	P60			P060	Error Text: Only valid BICs are allowed. Validation: Field 58 / <Cdtr> must be a valid BIC according BIC directory. Remark: TaskQueue / checked by PM
22	P62			P062	Error Text: BIC must be valid and have an RTGS account. Validation: BackupPayment CLS, EURO1: BIC of ECB (PM Static Data) is an Participant with account Remark: checked by PM / TaskQueue
24	P60			P060	Error Text: Only valid BICs are allowed. Validation: If within BackupPayment CLS, EURO1 BIC 52, 57 and 58 are used as subtypes it's not allowed to use BEID, TRCO and TESP Remark: TaskQueue / checked by PM
25	867	C7	XI00	2867	Error Text: BIC debtor and creditor must be different Validation: BIC of the credited and debited account must be different

Order	Error code				Error Text / Validation/ Remark
	SSP	Y-copy	V-shape	XML	

Remark: TaskQueue / checked by PM

BackupPayment_PM_1

Scope: BackupPayment CLS (CLS BIC <FnlAgt> is part of SSP Parameters held at Static Data)

MessageName for BackupPayment	<BckpPmt>
Message Header	<MsgHdr>
Message Identification	<MsgId>ABC123</MsgId>
End of Message Header	</MsgHdr>
Original Message ID	<OrgnlMsgId>
Message Identification	<MsgId>981201123456AA</MsgId>
End of Original Message ID	</OrgnlMsgId>
Payment Instruction Information	<InstrInf>
RequestedExecutionDateTime	<ReqdExctnDtTm>2008-07-21T08:35:30</ReqdExctnDtTm>
Payment Type	<PmtTp>
Payment type code	<Cd>CLS</Cd>
End Payment Type	</PmtTp>
End Payment Instruction Information	</InstrInf>
Transferred Amount	<TrfdAmt>
Amount without currency	<AmtWthtCcy>123456.12</AmtWthtCcy>
End of Transferred Amount	</TrfdAmt>
Creditor	<Cdtr>
Member Identification	<Mmbld>
BICFIIdentifier	<BICFI>DRESDEFFXXX</BICFI>
End of Member Identification	</Mmbld>
End of Creditor	</Cdtr>
CreditorAgent	<CdtrAgt>
Member Identification	<Mmbld>
BICFIIdentifier	<BICFI>CLSBUS33XXX</BICFI>
End of Member Identification	</Mmbld>
End of Creditor Agent	</CdtrAgt>
Debtor Agent	<DbtrAgt>
Member Identification	<Mmbld>
BICFIIdentifier	<BICFI>DEUTDEFFXXX</BICFI>
End of Member Identification	</Mmbld>
End of Debtor Agent	</DbtrAgt>
End of MessageName for BackupPayment	</BckpPmt>

BackupPayment_PM_2

Scope: BackupPayment EURO1 collateral account (EBA BIC "EBAPFRPPCOL" is part of SSP Parameters held at Static Data) - EURO1 is direct participant of SSP with a RTGS account.

MessageName for BackupPayment	<BckpPmt>
Message Header	<MsgHdr>
Message Identification	<MsgId>ABC123</MsgId>
End of Message Header	</MsgHdr>
Original Message ID	<OrgnlMsgId>
Message Identification	<MsgId>981201123456AA</MsgId>
End of Original Message ID	</OrgnlMsgId>
Transferred Amount	<TrfdAmt>
Amount without currency	<AmtWthtCcy>123456.12</AmtWthtCcy>
End of Transferred Amount	</TrfdAmt>
Creditor	<Cdtr>
Member Identification	<Mmbld>
BICFIIdentifier	<BICFI>EBAPFRPPCOL</BICFI>
End of Member Identification	</Mmbld>
End of Creditor	</Cdtr>
Debtor Agent	<DbtrAgt>
Member Identification	<Mmbld>
BICFIIdentifier	<BICFI>DEUTDEFFXXX</BICFI>
End of Member Identification	</Mmbld>
End of Debtor Agent	</DbtrAgt>
End of MessageName for BackupPayment	</BckpPmt>

BackupPayment_PM_3

Scope: BackupPayment EURO1 pre-settlement account (EBA BIC "EBAPFRPPPSA" is part of SSP Parameters held at Static Data) - EBA is direct participant of SSP with a RTGS account.

MessageName for BackupPayment	<BckpPmt>
Message Header	<MsgHdr>
Message Identification	<MsgId>ABC123</MsgId>
End of Message Header	</MsgHdr>
Original Message ID	<OrgnlMsgId>
Message Identification	<MsgId>981201123456AA</MsgId>
End of Original Message ID	</OrgnlMsgId>
Transferred Amount	<TrfdAmt>
Amount without currency	<AmtWthtCcy>123456.12</AmtWthtCcy>
End of Transferred Amount	</TrfdAmt>
Creditor	<Cdtr>
Member Identification	<Mmbld>
BICFIIdentifier	<BICFI>EBAPFRPPPSA</BICFI>
End of Member Identification	</Mmbld>
End of Creditor	</Cdtr>
Debtor Agent	<DbtrAgt>
Member Identification	<Mmbld>
BICFIIdentifier	<BICFI>DEUTDEFFXXX</BICFI>
End of Member Identification	</Mmbld>
End of Debtor Agent	</DbtrAgt>
End of MessageName for BackupPayment	</BckpPmt>

BackupPayment_PM_4

Scope: BackupPayment PM One direct Participant (SSP)

Messagename for BackupPayment	<BckpPmt>
Message Header	<MsgHdr>
Message Identification	<MsgId>ABC123</MsgId>
End of Message Header	</MsgHdr>
Transferred Amount	<TrfdAmt>
Amount without currency	<AmtWthtCcy>123456.12</AmtWthtCcy>
End of Transferred Amount	</TrfdAmt>
Creditor	<Cdtr>
Member Identification	<Mmbld>
BICFIIdentifier	<BICFI>DRESDEFFXXX</BICFI>
End of Member Identification	</Mmbld>
End of Creditor	</Cdtr>
End of Messagename for BackupPayment	</BckpPmt>

6. 4. 2 BackupPayment (for CBs only)

SSP Proprietary Messages

Scope: The BackupPayment message (for CB's only) is used to create backup liquidity redistribution and contingency payments in case the direct PM participant is temporarily not able to send SWIFTNet FIN messages. This request is only provided for CB in case on behalf of another PM Participant. Backup liquidity redistribution payments can be created in favour of other direct PM participants. Contingency payments can be created in favour of CLS and EURO1 (EURO1 collateral account and EURO1 pre-settlement account) .

The BackupPayment message can be sent by the application of a CB.

The BackupPayment message is replied by a Receipt message.
Non-Repudiation of Emission (NRE) is mandatory.

<camt.998.001.xx>

Structure:

Name Proprietary message	<PrtryMsg>
Message Header	<MsgHdr>
Message Identification	<MsgId></MsgId>
End of Message Header	</MsgHdr>
Proprietary Data	<PrtryData>
Type	<Tp>BackupPayment</Tp>
Proprietary Data	<Data>
SSP Proprietary Data	<SspPrtryDt>
Payment Instruction Reference	<PmtInstrRef>
Message business identification	<Id></Id>
End Payment Instruction Reference	</PmtInstrRef>
Payment Instruction Information	<InstrInf>
RequestedExecutionDateTime	<ReqdExctnDtTm></ReqdExctnDtTm>
Payment Type	<PmtTp>
Payment Type	<PmtTp></PmtTp>
End Payment Type	</PmtTp>
End Payment Instruction Information	</InstrInf>
Transferred Amount	<TrfdAmt>
Amount without currency	<AmtWthtCcy></AmtWthtCcy>
End of Transferred Amount	</TrfdAmt>
Creditor	<Cdtr>
Member Identification	<Mmbld>
BIC	<BIC></BIC>
End Member Identification	</Mmbld>
End of Creditor	</Cdtr>
Final Agent	<FnlAgt>
Member Identification	<Mmbld>
BIC	<BIC></BIC>
End Member Identification	</Mmbld>
End of Final Agent	</FnlAgt>
First Agent	<FrstAgt>
Member Identification	<Mmbld>
BIC	<BIC></BIC>
End Member Identification	</Mmbld>
End First Agent	</FrstAgt>
Debtor	<Dbtr>
Member Identification	<Mmbld>
BIC	<BIC></BIC>

End Member Identification					</Mmbld>
End of debtor					</Dbtr>
End of SSP Proprietary Data					</SspPrtryDt>
End of Proprietary Data					</Data>
End of Proprietary Data					</PrtryData>
End proprietary message					</PrtryMsg>

Attributes:

name of attribute	format	short description	description
<PrtryMsg>		Name Proprietary message Mandatory A2A	Validation:
<MsgHdr>		Message Header Mandatory A2A	Set of characteristics specific to the message Validation: [1..1]
<MsgId>-</MsgId>	16x	Message Identification Mandatory A2A	String of characters that uniquely identifies a message Validation: [1..1]
</MsgHdr>		End of Message Header Mandatory A2A	Validation: [1..1]
<PrtryData>		Proprietary Data Mandatory A2A	Proprietary Data Validation: [1..1]
<Tp>-</Tp>	35x	Type Mandatory A2A	here only BackupPayment is possible Validation: [1..1]
<Data>		Proprietary Data Mandatory	Proprietary data content Validation: [1..1]
<SspPrtryDt>		SSP Proprietary Data Mandatory A2A	SSP Proprietary Data Validation: [1..1]
<PmtInstrRef>		Payment Instruction Reference Optional A2A	Payment Instruction Reference Validation: [0..1]
<Id>-</Id>	16x	Message business identification Mandatory A2A	String of characters that uniquely identifies a message at senders side. Unique and unambiguous identifier for a message, as assigned by the Sender. This unique identifier can be used for cross-referencing purposes in subsequent messages. represents F21_RELATED_REF Validation: [1..1] max 16x used in Backup Payment CLS and EURO1
</PmtInstrRef>		End Payment Instruction Reference Optional A2A	End Payment Instruction Reference Validation: [0..1]
<InstrInf>		Payment Instruction Information	Payment Instruction Information represents F72 Sender to Receiver Information

name of attribute	format	short description	description
		Optional A2A	Validation: [0..1]
<ReqdExctnDtTm>		RequestedExecutionDateTi me Mandatory A2A	RequestedExecutionDateTime ISODatetime needed to fill CLS TIME_INDICATION Validation: *****[1..1] differs from the cash management standard only used in BackupPayment CLS, only time "08:35:30" is necessary for functional requirements, the date within the ISODatetime must indicate the date of current SSP business day
<PmtTp>		Payment Type Mandatory A2A	Payment Type Validation: *****[1..1] differs from the cash management standard only <PmtTp> is possible
<PmtTp>-</PmtTp>	3x	Payment Type Mandatory A2A	Payment Type3 CBS BCK BAL CLS CTR CBH CBP DPG DPN EXP TCH LMT LIQ DPP DPH DPS STF TRP TCS LOA LOR TCP OND MGL needed to fill CLS TIME_INDICATION Validation: [1..1] only used for BackupPayment CLS
</PmtTp>		End Payment Type Mandatory A2A	End Payment Type Validation: [1..1]
</InstrInf>		End Payment Instruction Information Optional A2A	End Payment Instruction Information Validation: [0..1]
<TrfdAmt>		Transferred Amount Mandatory A2A	The amount may be defined with or without the currency. <AmtWthCcy> CurrencyAndAmount <AmtWthCcy> ImpliedCurrencyAndAmount Validation: [1..1] in PM only <AmtWthCcy> is used. field must be followed by <Cdtr>
<AmtWthCcy>-	18n	Amount without currency	Number of monetary units specified in a currency where

name of attribute	format	short description	description
</AmtWthtCcy>			<p>the unit of currency is implied by the context.</p> <p>The integer part of Amount must contain at least one digit. The decimal separator is a dot '.'. It is not mandatory but included in the maximum length. The number of digits following the dot must not exceed the maximum number allowed for that specific currency as specified in ISO 4217.</p> <p>represents F32_AMOUNT</p> <p>Mandatory:</p> <p>A2A</p> <p>Validation:</p> <p>[1..1] in PM only 2 fraction digits are possible value restriction: maximum value 999.999.999.999,99 0,00 value is not allowed</p>
</TrfdAmt>		End of Transferred Amount	<p>Mandatory:</p> <p>A2A</p> <p>Validation:</p> <p>[1..1]</p>
<Cdtr>		Creditor	<p>represents F58_BIC</p> <p>Mandatory:</p> <p>A2A</p> <p>Validation:</p> <p>[1..1] used in Backup Payment CLS, SSP and EURO1 EURO1 pre-settlement account = fixed with EBAPFRPPPSA (EBA Clearing BIC for prefund participants deduced from SSP-Parameters) not changeable EURO1 colateral account= fixed with EBAPFRPPCOL (EBA Clearing-BIC deduced from SSP-Parameters) not changeable <Sysld> not used in PM The Creditor BIC must be different from the Debtor BIC</p>
<Mmbld>		Member Identification	<p>Mandatory:</p> <p>A2A</p> <p>Validation:</p> <p>[1..1] in PM only BIC is used</p>
<BIC>-</BIC>	4!a2!a2!c3!c	BIC	<p>A code allocated to a financial institution by a Registration Authority under an international identification scheme, as described in the latest edition of the international standard ISO 9362 "Banking - Banking telecommunication messages - Bank identifier codes".</p> <p>represents F58_BIC</p> <p>Mandatory:</p> <p>A2A</p> <p>Validation:</p> <p>[1..1] Field 58 / <Cdtr> must be a valid BIC according BIC directory. BackupPayment one Direct PM Participant Field 58 /<Cdtr> must be a valid BIC according participant table and must have an RTGS account.</p>
</Mmbld>		End Member Identification	<p>Mandatory:</p> <p>A2A</p> <p>Validation:</p> <p>[1..1]</p>
</Cdtr>		End of Creditor	<p>Mandatory:</p> <p>A2A</p> <p>Validation:</p> <p>[1..1]</p>
<FnIAgt>		Final Agent	<p>Provides details about a system and about a member of a system</p> <p>represents F57_BIC</p> <p>Optional:</p> <p>A2A</p> <p>Validation:</p> <p>[0..1] F57_BIC only used with F57_BIC : CLS BackupPayment = fixed with CLSBUS33XXX (CLS Clearing BIC deduced from SSP-Parameters) not changeable but optional in this request since the order type is detected by <PmtTp>CLS</PmtTp>!</p>

name of attribute	format	short description	description
			<Sysld> not used in PM
<Mmbld>		Member Identification Mandatory A2A	Validation: [1..1] in PM only BIC is used
<BIC>-</BIC>	4!a2!a2!c3!c BIC	Mandatory A2A	A code allocated to a financial institution by a Registration Authority under an international identification scheme, as described in the latest edition of the international standard ISO 9362 "Banking - Banking telecommunication messages - Bank identifier codes". represents F57_BIC Validation: [1..1] Field 57 / <FnlAgt> must be a valid BIC according BIC directory.
</Mmbld>		End Member Identification Mandatory A2A	Validation: [1..1]
</FnlAgt>		End of Final Agent Optional A2A	End of Final Agent Validation: [0..1]
<FrstAgt>		First Agent Optional A2A	FirstAgent in SSP only <Mmbld> with BIC possible represents F52_BIC Validation: [0..1] Ordering / Instructing Institution in Backup Payment CLS and EURO1 (preallocated with the instructing institution but changeable) <Sysld> not used in PM
<Mmbld>		Member Identification Mandatory A2A	Validation: [1..1] in PM only BIC is used
<BIC>-</BIC>	4!a2!a2!c3!c BIC	Mandatory A2A	A code allocated to a financial institution by a Registration Authority under an international identification scheme, as described in the latest edition of the international standard ISO 9362 "Banking - Banking telecommunication messages - Bank identifier codes". represents F52_BIC Validation: [1..1] Field 52 / <FrstAgt> must be a valid BIC according BIC directory.
</Mmbld>		End Member Identification Mandatory A2A	Validation: [1..1]
</FrstAgt>		End First Agent Optional A2A	End First Agent Validation: [0..1]
<Dbtr>		Debtor Optional	Information about the debtor of a payment. Validation:

name of attribute	format	short description	description
		A2A	[0..1]Specifies the participant who is the debtor of the BackupPayment, mandatory if the CB acts on behalf of another SSP member, when not stated the BIC of the CB is used
<Mmbld>		Member Identification	
		Mandatory	Validation:
		A2A	[1..1]
<BIC>-</BIC>	4!a2!a2!c3!c	BIC	A code allocated to a financial institution by a Registration Authority under an international identification scheme, as described in the latest edition of the international standard ISO 9362 "Banking - Banking telecommunication messages - Bank identifier codes".
		Mandatory	Validation:
		A2A	[1..1]
</Mmbld>		End Member Identification	
		Mandatory	Validation:
		A2A	[1..1]
</Dbtr>		End of debtor	
		Optional	Validation:
		A2A	[0..1]
</SspPrtryDt>		End of SSP Proprietary Data	End of Root element for all SSP proprietary data
		Mandatory	Validation:
		A2A	[1..1]
</Data>		End of Proprietary Data	
		Mandatory	Validation:
			[1..1]
</PrtryData>		End of Proprietary Data	End of Proprietary Data
		Mandatory	Validation:
		A2A	[1..1]
</PrtryMsg>		End proprietary message	
		Mandatory	Validation:
		A2A	

Error Codes:

Order	Error code				Error Text / Validation/ Remark
	SSP	Y-copy	V-shape	XML	
1	X00			0000	<p>Error Text: O.k.</p> <p>Validation: Confirmation, that a task is stored in the task queue. A related reference for the subsequent processing (e.g. confirmation) of the task is returned.</p> <p>Remark: Receipt (status code)</p>
2	X44			1404	<p>Error Text: If "non repudiation of emission" is mandatory, the NRE indicator flag has to be present</p> <p>Validation: If non-repudiaton processing is mandatory, the tag <SwInt:NRIndicator>TRUE</SwInt:NRIndicator> has to be present.</p> <p>Remark: checked by ICM / Receipt</p>
3	X41			1401	<p>Error Text: No permission. RBAC User role(s) are not sufficient.</p> <p>Validation: message is allowed for central banks only. RBAC role name "APPLICBTE" is required</p> <p>Remark: checked by ICM / Receipt</p>
4	X47			1407	<p>Error Text: No authorisation. User is not allowed acting on behalf of another Participant as Central Bank</p> <p>Validation: Dbtr/Mmbld/BIC value must indicate a participant who the CB is responsible for</p> <p>Remark: checked by ICM / Receipt</p>
5	867	C7	XI00	2867	<p>Error Text: BIC debtor and creditor must be different</p> <p>Validation: Cdtr/Mmbld/BIC and Dbtr/Mmbld/BIC the Creditor BIC must be different from the Debtor BIC.</p> <p>Remark: checked by ICM/ Receipt</p>
6	P62			P062	<p>Error Text: BIC must be valid and have an RTGS account.</p> <p>Validation: Dbtr/Mmbld/BIC must indicate a SSP Participant</p> <p>Remark: checked by ICM/ Receipt</p>
7	871	D1	DT01	2871	<p>Error Text: Backup payment is not allowed / Value date in past not allowed</p> <p>Validation: The National Help Desk has to activate the backup functionality in the ICM for the PM participant.</p> <p>Remark: checked by ICM/ Receipt</p>
8	P96	T3		P126	<p>Error Text: Date is not the current SSP business day</p> <p>Validation: ReqdExctnDtTm: date within the ISODateTime must indicate the date of current SSP business day</p> <p>Remark: checked by ICM / Receipt</p>
9	P60			P060	<p>Error Text: Only valid BICs are allowed.</p> <p>Validation: If <PmtTp> is filled with CLS, the CLS Clearing BIC has to be filled in <FnlAgt><Mmbld><BIC></p> <p>Remark: checked by ICM / Receipt</p>
10	869			2869	<p>Error Text: Backup to TARGET1 is no longer supported.</p> <p>Validation: FinalAgent may only be filled with the BIC of CLS. (<PmtTp> has to be filled with "CLS".) There is no longer a non-migrated CB that can be indicated.</p> <p>Remark: checked by ICM / Receipt</p>
11	P94			P124	<p>Error Text: Requested time must be later than opening time of SSP</p> <p>Validation: The <ReqdExctnDtTm> /CLSTIME cannot be earlier than the opening time of SSP (Start of Day Trade).</p> <p>Remark: checked by ICM / Receipt</p>

Order	Error code				Error Text / Validation/ Remark
	SSP	Y-copy	V-shape	XML	
12	P85			P115	Error Text: Requested time must be before closing time of SSP Validation: The <ReqdExctnDtTm> / CLSTime cannot be later than the closing time of SSP (Cut-off-Bank-to-Bank). Remark: checked by ICM / Receipt
13	X40			1400	Error Text: BIC must indicate a SSP participant Validation: BIC must indicate a SSP Participant Remark: checked by ICM/ Receipt
14	866	C6	AC06	2866	Error Text: Exclusion of participant Validation: If requestor is direct participant or ancillary system or GoA manager and this requestor is excluded, no change of data is allowed Remark: checked by PM / TaskQueue
15	P62			P062	Error Text: BIC must be valid and have an RTGS account. Validation: Cdtr/Mmbld/BIC must indicate a SSP Participant. Exception: if the BackupPayment is a CLS BackupPayment, this check will not be executed. Remark: checked by PM/ TaskQueue
16	894	K4		2894	Error Text: Function is not allowed in the current business day phase Validation: SSP is open Remark: checked by PM / TaskQueue
17	862	C2	TM01	2862	Error Text: Request out of cut-off time Validation: Possibility to use this function during the current phase of business day. Remark: checked by PM / TaskQueue
19	P60			P060	Error Text: Only valid BICs are allowed. Validation: Field 58 / <Cdtr> must be a valid BIC according BIC directory. Remark: TaskQueue / checked by PM
20	P60			P060	Error Text: Only valid BICs are allowed. Validation: If used field 57 / <FnlAgt> must be a valid BIC according BIC directory. Remark: TaskQueue / checked by PM
21	P60			P060	Error Text: Only valid BICs are allowed. Validation: If used field 52 / <FrstAgt> must be a valid BIC according BIC directory. Remark: TaskQueue / checked by PM
22	P62			P062	Error Text: BIC must be valid and have an RTGS account. Validation: BackupPayment one Direct PM Participant Field 58 /<Cdtr> must be a valid BIC according participant table and must have an RTGS account with Account Type 'Normal', 'CB' or 'CB Customer Liquidity Bridge'. Only for backup payments to direct PM participant Remark: TaskQueue / checked by PM
24	P60			P060	Error Text: Only valid BICs are allowed. Validation: If within BackupPayment CLS, EURO1 BIC 52, 57 and 58 are used as subtypes it's not allowed to use BEID, TRCO and TESP Remark: TaskQueue / checked by PM
26	P62			P062	Error Text: BIC must be valid and have an RTGS account.

Order	Error code				Error Text / Validation/ Remark
	SSP	Y-copy	V-shape	XML	
					Validation: BackupPayment CLS, EURO1: BIC of ECB (PM Static Data) is an Participant with account. Remark: checked by PM / TaskQueue
27	867	C7	XI00	2867	Error Text: BIC debtor and creditor must be different Validation: BIC of the credited and debited account must be different Remark: TaskQueue / checked by PM

BackupPayment_PM_5

Scope: Backup Payment CLS, message of a central bank acting on behalf of a PM Participant (CLS BIC is part of SSP Parameters held at Static Data)

Name Proprietary message	<PrtryMsg>
Message Header	<MsgHdr>
Message Identification	<MsgId>ABC123</MsgId>
End of Message Header	</MsgHdr>
Proprietary Data	<PrtryData>
Type	<Tp>BackupPayment</Tp>
Proprietary Data	<Data>
SSP Proprietary Data	<SspPrtryDt>
Payment Instruction Reference	<PmtInstrRef>
Message business identification	<Id>985620</Id>
End Payment Instruction Reference	</PmtInstrRef>
Payment Instruction Information	<InstrInf>
RequestedExecutionDateTime	<ReqdExctnDtTm>2008-07-21T08:35:30</ReqdExctnDtTm>
Payment Type	<PmtTp>
Payment Type	<PmtTp>CLS</PmtTp>
End Payment Type	</PmtTp>
End Payment Instruction Information	</InstrInf>
Transferred Amount	<TrfdAmt>
Amount without currency	<AmtWthtCcy>500000.00</AmtWthtCcy>
End of Transferred Amount	</TrfdAmt>
Creditor	<Cdtr>
Member Identification	<Mmbld>
BIC	<BIC>DRESDEFFXXX</BIC>
End Member Identification	</Mmbld>
End of Creditor	</Cdtr>
Final Agent	<FnIAgt>
Member Identification	<Mmbld>
BIC	<BIC>CLSBUS33XXX</BIC>
End Member Identification	</Mmbld>
End of Final Agent	</FnIAgt>
First Agent	<FrstAgt>
Member Identification	<Mmbld>
BIC	<BIC>DEUTDEFF300</BIC>
End Member Identification	</Mmbld>
End First Agent	</FrstAgt>
Debtor	<Dbtr>
Member Identification	<Mmbld>
BIC	<BIC>DEUTDEFF500</BIC>
End Member Identification	</Mmbld>
End of debtor	</Dbtr>
End of SSP Proprietary Data	</SspPrtryDt>
End of Proprietary Data	</Data>
End of Proprietary Data	</PrtryData>
End proprietary message	</PrtryMsg>

BackupPayment_PM_6

Scope: Backup Payment EURO1 collateral account, message of a central bank acting on behalf of a PM Participant (EBA BIC "EBAPFRPPCOL" is part of SSP Parameters held at Static Data) - EURO1 is direct participant of SSP with a RTGS account.

Name Proprietary message	<PrtryMsg>
Message Header	<MsgHdr>
Message Identification	<MsgId>ABC123</MsgId>
End of Message Header	</MsgHdr>
Proprietary Data	<PrtryData>
Type	<Tp>BackupPayment</Tp>
Proprietary Data	<Data>
SSP Proprietary Data	<SspPrtryDt>
Payment Instruction Reference	<PmtInstrRef>
Message business identification	<Id>985620</Id>
End Payment Instruction Reference	</PmtInstrRef>
Transferred Amount	<TrfdAmt>
Amount without currency	<AmtWthtCcy>123456.12</AmtWthtCcy>
End of Transferred Amount	</TrfdAmt>
Creditor	<Cdtr>
Member Identification	<Mmbld>
BIC	<BIC>EBAPFRPPCOL</BIC>
End Member Identification	</Mmbld>
End of Creditor	</Cdtr>
First Agent	<FrstAgt>
Member Identification	<Mmbld>
BIC	<BIC>DEUTDEFF300</BIC>
End Member Identification	</Mmbld>
End First Agent	</FrstAgt>
Debtor	<Dbtr>
Member Identification	<Mmbld>
BIC	<BIC>DEUTDEFF500</BIC>
End Member Identification	</Mmbld>
End of debtor	</Dbtr>
End of SSP Proprietary Data	</SspPrtryDt>
End of Proprietary Data	</Data>
End of Proprietary Data	</PrtryData>
End proprietary message	</PrtryMsg>

BackupPayment_PM_7

Scope: Backup Payment EURO1 pre-settlement account, message of a central bank acting on behalf of a PM Participant (EBA BIC "EBAPFRPPPSA" is part of SSP Parameters held at Static Data) - EBA is direct participant of SSP with a RTGS account.

Name Proprietary message	<PrtryMsg>
Message Header	<MsgHdr>
Message Identification	<MsgId>ABC123</MsgId>
End of Message Header	</MsgHdr>
Proprietary Data	<PrtryData>
Type	<Tp>BackupPayment</Tp>
Proprietary Data	<Data>
SSP Proprietary Data	<SspPrtryDt>
Transferred Amount	<TrfdAmt>
Amount without currency	<AmtWthtCcy>500000.00</AmtWthtCcy>
End of Transferred Amount	</TrfdAmt>
Creditor	<Cdtr>
Member Identification	<Mmbld>
BIC	<BIC>EBAPFRPPPSA</BIC>
End Member Identification	</Mmbld>
End of Creditor	</Cdtr>
First Agent	<FrstAgt>
Member Identification	<Mmbld>
BIC	<BIC>DEUTDEFF300</BIC>
End Member Identification	</Mmbld>
End First Agent	</FrstAgt>
Debtor	<Dbtr>
Member Identification	<Mmbld>
BIC	<BIC>DEUTDEFF500</BIC>
End Member Identification	</Mmbld>
End of debtor	</Dbtr>
End of SSP Proprietary Data	</SspPrtryDt>
End of Proprietary Data	</Data>
End of Proprietary Data	</PrtryData>
End proprietary message	</PrtryMsg>

BackupPayment_PM_8

Scope: Backup Payment to one direct participant (SSP), message of a central bank acting on behalf of a PM Participant

Name Proprietary message	<PrtryMsg>
Message Header	<MsgHdr>
Message Identification	<MsgId>ABC123</MsgId>
End of Message Header	</MsgHdr>
Proprietary Data	<PrtryData>
Type	<Tp>BackupPayment</Tp>
Proprietary Data	<Data>
SSP Proprietary Data	<SspPrtryDt>
Transferred Amount	<TrfdAmt>
Amount without currency	<AmtWthtCcy>999999999.99</AmtWthtCcy>
End of Transferred Amount	</TrfdAmt>
Creditor	<Cdtr>
Member Identification	<Mmbld>
BIC	<BIC>DRESDEFFXXX</BIC>
End Member Identification	</Mmbld>
End of Creditor	</Cdtr>
Debtor	<Dbtr>
Member Identification	<Mmbld>
BIC	<BIC>DEUTDEFF500</BIC>
End Member Identification	</Mmbld>
End of debtor	</Dbtr>
End of SSP Proprietary Data	</SspPrtryDt>
End of Proprietary Data	</Data>
End of Proprietary Data	</PrtryData>
End proprietary message	</PrtryMsg>

6. 4. 3 CancelTransaction

Cash Management Standard

CancelTransaction_PM

Scope: The CancelTransaction message is used to cancel a pending or an earmarked payment in the payment queue. Only the sender of a payment, his central bank, his Virtual Account Manager (if exists) is able to revoke the payment. In case of (an) excluded participant(s) only his central bank can trigger the revocation.

The customer has to ask for the SSP Booking ID <PrtryRef> by sending a GetTransaction, first. Afterwards, this reference has to be used to identify the booking order to be cancelled.

The CancelTransaction message is replied by a Receipt message.
Non-Repudiation of Emission (NRE) is mandatory.

<camt.008.001.xx>

Structure:

Message name for CancelTransaction	<CcITx>
Message Header	<MsgHdr>
Message Identification	<MsgId></MsgId>
End of Message Header	</MsgHdr>
PaymentIdentification	<PmtId>
Choice	xorLngBizIdPrtryId
LongBusinessIdentification	<LngBizId>
TransactionIdentification 16x	<TxId></TxId>
ImpliedCurrencyAndAmount	<IntrBkSttlmAmt></IntrBkSttlmAmt>
Value date	<IntrBkSttlmDt></IntrBkSttlmDt>
PaymentMethod	<PmtMtd>
Choice	xorFINMTPrtry
FINMessageType	<FINMT></FINMT>
ProprietaryPaymentOriginType	<Prtry></Prtry>
End of Choice	/xorFINMTPrtry
End Payment Method	</PmtMtd>
Instructing Agent	<InstgAgt>
Financial Institution Identification	<FinInstnId>
BICFIIdentifier	<BICFI></BICFI>
End of Financial Institution Identification	</FinInstnId>
End of Instructing Agent	</InstgAgt>
Instructed Agent	<InstdAgt>
Financial Institution Identification	<FinInstnId>
BICFIIdentifier	<BICFI></BICFI>
End of Financial Institution Identification	</FinInstnId>
End of Instructed Agent	</InstdAgt>
EndToEndIdentification	<EndToEndId></EndToEndId>
End LongBusinessIdentification	</LngBizId>
ProprietaryId	<PrtryId></PrtryId>
End of choice	/xorLngBizIdPrtryId
EndPaymentIdentification	</PmtId>
End of Message name for CancelTransaction	</CcITx>

Attributes:

name of attribute	format	short description	description
<CcITx>		Message name for CancelTransaction Mandatory A2A	Validation: Cancellation of payments are only possible for status of payments queued and earmarked. Only the sender of a payment, his central bank or user group profile SSP is able to revoke the payment.
<MsgHdr>		Message Header Mandatory A2A	Set of characteristics specific to the message Validation: [1..1]
<MsgId>-</MsgId>	35x	Message Identification Mandatory A2A	Message Identification Validation: [1..1]
</MsgHdr>		End of Message Header Mandatory A2A	Validation: [1..1]
<PmtId>		PaymentIdentification Mandatory A2A	Set of elements to provide further means of referencing a payment transaction unique and unambiguous identification of a payment Validation: [1..1]
xorLngBizIdPrtryId		Choice Mandatory	PaymentIdentificationChoice: Choice between <LngBizId> and <PrtryId> Validation:
<LngBizId>		LongBusinessIdentification Mandatory A2A	Identifies a payment instruction by a set of characteristics which provides an unambiguous identification of the instruction. TransactionIdentification InterBankSettlementAmount InterBankSettlementDate PaymentMethod InstructingAgent InstructedAgent EndToEndIdentification Validation: [1..1]
<TxId>-</TxId>	16x	TransactionIdentification 16x Mandatory	Unique and unambiguous identification of a payment transaction, as assigned by the originator. The payment transaction reference is used for reconciliation or to link tasks relating to the payment transaction. Validation: [1..1]
<IntrBkSttlmAmt>-</IntrBkSttlmAmt>		ImpliedCurrencyAndAmount Mandatory	ImpliedCurrencyAndAmount Validation: [1..1]
<IntrBkSttlmDt>-</IntrBkSttlmDt>	ISODate	Value date Mandatory	Value date Validation: [1..1]

name of attribute	format	short description	description
<PmtMtd>		PaymentMethod	PaymentMethod
		Mandatory	Validation: [1..1]
xorFINMTPrtry		Choice	Choice amongst <FINMT> and <Prtry>
		Mandatory	Validation:
<FINMT>-</FINMT>	3ln	FINMessageType	possible values: 103 202 204
		Mandatory	Validation: [1..1]
<Prtry>-</Prtry>	6c	ProprietaryPaymentOriginType	ASXML = Bookings stemming from incoming AS XML payments T2SXML = Bookings stemming from incoming T2S XML payments T2SXML = Bookings stemming from incoming TIPS XML payments INTERN = Bookings stemming from internal messages ORDER = Bookings stemming from current orders sent via ICM
		Mandatory	Validation: [1..1]Only the values ASXML, T2SXML, TIPSXML, INTERN and ORDER are allowed: ASXML: The result set will include all bookings stemming from an incoming AS XML payments (incl. SBTransferInitiation). T2SXML: The result set will include all bookings stemming from an incoming T2S XML payments INTERN: The result set will include all bookings stemming from internal messages: - Automatic processing by PM, including Standing Orders - Payments delivered from HAM (e.g. Simplified MT202), RM, SF, CRISP, CM ORDER: The result set will include all bookings stemming from current orders sent via ICM. (E.g. Backup Payments. - But not SBTransferInitiation.)
/xorFINMTPrtry		End of Choice	
		Mandatory	Validation:
</PmtMtd>		End Payment Method	
		Mandatory	Validation: [1..1]
<InstgAgt>		Instructing Agent	Instructing Agent
		Mandatory	Validation: [1..1]
<FinInstnId>		Financial Institution Identification	Financial Institution Identification
		Mandatory	Validation: [1..1]
<BICFI>-</BICFI>	4!a2!a2!c3!c	BICFIIdentifier	BICFIIdentifier - Sender - FirstAgent BIC in case of AS XML payments
		Mandatory	Validation: [1..1]

name of attribute	format	short description	description
</FinInstnId>		End of Financial Institution Identification Mandatory	End of Financial Institution Identification Validation: [1..1]
</InstgAgt>		End of Instructing Agent Mandatory	End of Instructing Agent Validation: [1..1]
<InstdAgt>		Instructed Agent Mandatory	Instructed Agent Validation: [1..1]
<FinInstnId>		Financial Institution Identification Mandatory	Financial Institution Identification Validation: [1..1]
<BICFI>-</BICFI>	4!a2!a2!c3!c	BICFIIdentifier Mandatory	BICFIIdentifier - Receiver - FinalAgent BIC in case of AS XML payments Validation: [1..1]
</FinInstnId>		End of Financial Institution Identification Mandatory	End of Financial Institution Identification Validation: [1..1]
</InstdAgt>		End of Instructed Agent Mandatory	End of Instructed Agent Validation: [1..1]
<EndToEndId>-</EndToEndId>	16x	EndToEndIdentification Optional	Unique and unambiguous identification of a payment transaction, as assigned by any of the parties on the initiating side, that will be passed on throughout the entire end-to-end chain Validation: [0..1]
</LngBizId>		End LongBusinessIdentification Mandatory	End LongBusinessIdentification Validation: [1..1]
<PrtryId>-</PrtryId>	16n	ProprietaryId Mandatory	ProprietaryId SSP-Reference (generated by PM [16x]; unique identifier of a business case - Note: Some business cases consist of several bookings.) SSP-Reference will be delivered within every the ReturnTransaction message. Validation: [1..1] Only transactions with an unambiguous SSP-Reference can be cancelled.
/xorLngBizIdPrtryId		End of choice Mandatory	End of PaymentIdentificationChoice Validation:
</PmtId>		EndPaymentIdentification	End of Set of elements to reference a payment transaction

name of attribute	format	short description	description
		Mandatory A2A	Validation: [1..1]
</CclTx>		End of Messagename for CancelTransaction Mandatory A2A	Validation:

Error Codes:

Order	Error code				Error Text / Validation/ Remark
	SSP	Y-copy	V-shape	XML	
1	X00			0000	Error Text: O.k. Validation: Confirmation, that a task is stored in the task queue. A related reference for the subsequent processing (e.g. confirmation) of the task is returned. Remark: Receipt (status code)
2	X44			1404	Error Text: If "non repudiation of emission" is mandatory, the NRE indicator flag has to be present Validation: If non-repudiaton processing is mandatory, the tag <SwInt:NRIndicator>TRUE</SwInt:NRIndicator> has to be present. Remark: checked by ICM / Receipt
3	X41			1401	Error Text: No permission. RBAC User role(s) are not sufficient. Validation: RBAC role name "APPLICATE", "APPLICSTE" or "APPLICBTE" are required Remark: checked by ICM / Receipt
4	X42			1402	Error Text: No authorisation. User is not allowed acting on behalf of another participant. Validation: PrtryRef (profile credit institution) value must indicate a transaction sent by the te SSP Participant itself or by a participant the SSP participant is entitled to act on behalf of Remark: checked by ICM / Receipt
5	X45			1405	Error Text: No authorisation or rather interaction not possible. User is not allowed acting on behalf of another participant as Group of Account manager Validation: PrtryRef (profile group of account manager) the sender of the related transaction must belong to a group of accounts the participant is the manager of Remark: checked by ICM / Receipt
6	X47			1407	Error Text: No authorisation. User is not allowed acting on behalf of another Participant as Central Bank Validation: PrtryRef (profile central bank) value must indicate a transaction sent by a participant the CB is responsible for Remark: checked by ICM / Receipt
10	862	C2	TM01	2862	Error Text: Request out of cut-off time Validation: Possibility to use this function during the current phase of business day. Remark: checked by PM /TaskQueue
11	866	C6	AC06	2866	Error Text: Exclusion of participant Validation: If requestor is direct participant or ancillary system or GoA manager and this requestor is excluded, no change of data is allowed Remark: checked by PM / TaskQueue
12	P13			P013	Error Text: No payment found Validation: there has to be a payment which can be revoked Remark: checked by PM / TaskQueue
13	P13			P013	Error Text: No payment found Validation: PrtryRef does exist Remark: checked by PM/ TaskQueue
14	P71			P101	Error Text: You are not allowed to revoke the payment(s)

Order	Error code				Error Text / Validation/ Remark
	SSP	Y-copy	V-shape	XML	
					Validation: Only the sender (Creditor MT204) of a payment, his Virtual Account Manager (if exists), his central bank can do this only on behalf. Remark: checked by PM / TaskQueue
15	P71			P101	Error Text: You are not allowed to revoke the payment(s) Validation: In case of (an) excluded participant(s) only his central bank can trigger the revocation. The orderer must not be excluded. Remark: checked by PM / TaskQueue
16	894	K4		2894	Error Text: Function is not allowed in the current business day phase Validation: SSP is open Remark: checked by PM / TaskQueue
17	X40			1400	Error Text: BIC must indicate a SSP participant Validation: BIC must indicate a SSP participant Remark: checked by PM TaskQueue
18	P71			P101	Error Text: You are not allowed to revoke the payment(s) Validation: Only the sender (Debtor MT202, MT103) of a payment, his central bank, his Virtual Account Manager (if exists) can do this only on behalf. Remark: checked by PM / TaskQueue
19	P71			P101	Error Text: You are not allowed to revoke the payment(s) Validation: in case of AS payments a revocation is only possible in connection with settlement procedures 1, 2, 3 Remark: checked by PM / TaskQueue
20	P71			P101	Error Text: You are not allowed to revoke the payment(s) Validation: in case of AS payments a revocation is only possible by the CB responsible for the AS Remark: checked by PM / TaskQueue
21	P70			P100	Error Text: Function is only possible for AS: "info period", all other: "warehoused", "pending" (but not for change earliest debit time) and "earmarked" Validation: the payment must not be final (only queued or earmarked) Remark: checked by PM / TaskQueue

CancelTransaction_PM_1

Scope: CancelTransaction via PM Reference (SSP-Reference)

MessageName for CancelTransaction	<CclTx>
Message Header	<MsgHdr>
Message Identification	<MsgId>ABC123</MsgId>
End of Message Header	</MsgId>
PaymentIdentification	<PmtId>
ProprietaryId	<PrtryId>1234</PrtryId>
EndPaymentIdentification	</PmtId>
End of MessageName for CancelTransaction	</CclTx>

CancelTransaction_PM_2

Scope: CancelTransaction via LongBusinessIdentification

MessageName for CancelTransaction	<CclTx>
Message Header	<MsgHdr>
Message Identification	<MsgId>ABC123</MsgId>
End of Message Header	</MsgHdr>
PaymentIdentification	<PmtId>
LongBusinessIdentification	<LngBizId>
TransactionIdentification 16x	<TxId>12345FEDCBA</TxId>
ImpliedCurrencyAndAmount	<IntrBkSttlmAmt>1000.00</IntrBkSttlmAmt>
Value date	<IntrBkSttlmDt>2012-06-01</IntrBkSttlmDt>
PaymentMethod	<PmtMtd>
FINMessageType	<FINMT>202</FINMT>
End Payment Method	</PmtMtd>
Instructing Agent	<InstgAgt>
Financial Institution Identification	<FinInstnId>
BICFIIdentifier	<BICFI>DEUTDEFFXXX</BICFI>
End of Financial Institution Identification	</FinInstnId>
End of Instructing Agent	</InstgAgt>
Instructed Agent	<InstdAgt>
Financial Institution Identification	<FinInstnId>
BICFIIdentifier	<BICFI>DRESDEFFXXX</BICFI>
End of Financial Institution Identification	</FinInstnId>
End of Instructed Agent	</InstdAgt>
End LongBusinessIdentification	</LngBizId>
EndPaymentIdentification	</PmtId>
End of MessageName for CancelTransaction	</CclTx>

6. 4. 4 DeleteLimit

Cash Management Standard

DeleteLimit_PM

Scope: The DeleteLimit message is used to delete

- a current bilateral limit
- the current multilateral limit
- all current bilateral limits (separate tasks for every bilateral limit; the multilateral limit is deleted automatically) which was defined in the past. The deletion of a current limit will become effective immediately.

ModifyLimit can be used for deletion of limits, too, and supports additional business cases. In a ReturnTask message it's never presented the original customer message but a recreated XML structure. In case of DeleteLimit you'll find a ModifyLimit instead. If all bilateral limits are deleted with one request within a ReturnTask it is presented one ModifyLimit (new value: zero) per deleted bilateral limit/per task queue reference.

The DeleteLimit message can be sent by the application of a direct PM participant or the application of a group of accounts manager ("virtual account" definition and change of limits and in case of bilateral limits against bilateral counterparts, possible for the whole group only, not for the single account holder)

If a participant is a member of an account group, the limit can only be defined against the whole group. Therefore limits that are defined against an account group have to be defined against the BIC of the group of accounts manager.

The DeleteLimit message is replied by a Receipt message. The Receipt can contain multiple ReceiptDetails (if all bilateral limits shall be deleted) - one per affected limit. In case a remarkable number of limits is affected it may happen that a time-out message is returned. Then the customer application may send a GetPendingData request to get the Receipt with the list of task queue references.

Non-Repudiation of Emission (NRE) is supported.

<camt.012.001.xx>

Structure:

Message name for DeleteLimit	<DelLmt>
Message Header	<MsgHdr>
Message Identification	<MsgId></MsgId>
End of Message Header	</MsgHdr>
LimitDetails	<LmtDtls>
choice amongst	xorCurLmtIdAllCurLmts
Current Limit Identification	<CurLmtId>
BilateralLimitCounterpartyId	<BilLmtCtrPtyId>
Financial Institution Identification	<FinInstnId>
BICFIIdentifier	<BICFI></BICFI>
End of Financial Institution Identification	</FinInstnId>
End of BilateralLimitCounterpartyId	</BilLmtCtrPtyId>
Limit Type	<Tp>
Limit Type Code	<Cd></Cd>
End of Limit Type	</Tp>
Account Owner	<AcctOwnr>
Financial Institution Identification	<FinInstnId>
BICFIIdentifier	<BICFI></BICFI>
End of Financial Institution Identification	</FinInstnId>
End of Account owner	</AcctOwnr>
End of CurrentLimitIdentification	</CurLmtId>
Identification of the current limit.	<AllCurLmts>
Limit Type	<Tp>
Limit Type Code	<Cd></Cd>
End of Limit Type	</Tp>
Account Owner	<AcctOwnr>
Financial Institution Identification	<FinInstnId>
BICFIIdentifier	<BICFI></BICFI>
End of Financial Institution Identification	</FinInstnId>

End of Account owner					</AcctOwnr>
End of Identification of the current limit.					</AllCurLmts>
End choice amongst					/xorCurLmtIdAllCurLmts
End Limit Details					</LmtDtls>
End of Messagename for DeleteLimit					</DelLmt>

Attributes:

name of attribute	format	short description	description
<DelLmt>		Message name for DeleteLimit Mandatory A2A	Validation: [1..1]
<MsgHdr>		Message Header Mandatory A2A	Set of characteristics specific to the message Validation: [1..1]
<MsgId>-</MsgId>	35x	Message Identification Mandatory A2A	Message Identification Validation: [1..1]
</MsgHdr>		End of Message Header Mandatory A2A	Validation: [1..1]
<LmtDtls>		LimitDetails Mandatory	Identification of the details of one particular limit. Validation: [1..1]
xorCurLmtIdAllCurLmts		choice amongst Mandatory	Validation:
<CurLmtId>		Current Limit Identification Mandatory A2A	Validation: [1..1]
<BilLmtCtrPtyId>		BilateralLimitCounterpartyId Optional A2A	Unique and unambiguous identification of a member within a system, assigned using the member identification scheme of the system. Validation: [0..1] Counterpart is filled in the case of an asked Bilateral Limit. If multilateral Limit is used as LimitType this tag should not be used In PM only BIC is used
<FinInstnId>		Financial Institution Identification Mandatory	Financial Institution Identification Validation: [1..1]
<BICFI>-</BICFI>	4!a2!a2!c3!c	BICFIIdentifier Mandatory A2A	BICFIIdentifier Validation: [1..1] There has to be a current bilateral limit for the mentioned counterpart else an error is returned.
</FinInstnId>		End of Financial Institution Identification Mandatory	End of Financial Institution Identification Validation: [1..1]
</BilLmtCtrPtyId>		End of BilateralLimitCounterpartyId Optional A2A	End ofBilateralLimitCounterpartyIdentification Validation: [0..1]

name of attribute	format	short description	description
<Tp>		Limit Type	Limit Type
		Mandatory	Validation:
		A2A	[1..1]
<Cd>-</Cd>		Limit Type Code	Limit Type Code
			SSP restricted code list:
			BILL = Bilateral Limit is applied by one party to a specific counterparty, and corresponds to the maximum amount of traffic party setting the limit can send to that counterparty. The limit can be expressed as a debit or a credit limit. With the help of a bilateral limit, the direct participant restricts the use of liquidity when clearing payments with another direct participant.
			MULT = Multilateral Limit is a maximum amount value applied to, or by, a participant to a set of counterparties. The multilateral limit is taken into account by the transaction administrator to contain the risk in the system. With the help of the multilateral limit, the direct participant restricts the use of liquidity when clearing payments with all other direct participants for which no bilateral limit is set
		Mandatory	Validation:
			[1..1]MULT can only be used if there is an existing current multilateral limit.
</Tp>		End of Limit Type	End of Limit Type
		Mandatory	Validation:
			[1..1]
<AcctOwnr>		Account Owner	
		Optional	Validation:
		A2A	[0..1]
<FinInstnId>		Financial Institution Identification	Financial Institution Identification
		Mandatory	Validation:
			[1..1]
<BICFI>-</BICFI>	4!a2!a2!c3!c	BICFIIdentifier	BICFIIdentifier
			e.g. needed on behalf of third parties if e. g. the NCB are able to start several transactions on behalf their national banking community.
			BIC of the RTGS main account / in case of group of accounts virtual account the BIC of the group of accounts manager
		Optional	Validation:
			[0..1] In the case of "on behalf" scenario (sending party not Account Owner) mandatory. When not stated the BIC of the participant is used. Usage of AccountOwner is only allowed once per request. The sender has to be authorized to work on behalf of the mentioned account owner. A CB can only fill in BICs of participants she is responsible for; a GoA manager may only enter his own BIC.
</FinInstnId>		End of Financial Institution Identification	End of Financial Institution Identification
		Mandatory	Validation:
			[1..1]

name of attribute	format	short description	description
</AcctOwnr>		End of Account owner Optional	Validation: [0..1]
</CurLmtId>		End of CurrentLimitIdentification Mandatory A2A	End of CurrentLimit Validation: [1..1]
<AllCurLmts>		Identification of the current limit. Mandatory	Validation: [1..1]
<Tp>		Limit Type Mandatory A2A	Limit Type Validation: [1..1]
<Cd>-</Cd>		Limit Type Code Mandatory	Limit Type Code SSP restricted code list: BILI = Bilateral Limit is applied by one party to a specific counterparty, and corresponds to the maximum amount of traffic party setting the limit can send to that counterparty. The limit can be expressed as a debit or a credit limit. With the help of a bilateral limit, the direct participant restricts the use of liquidity when clearing payments with another direct participant. MULT = Multilateral Limit is a maximum amount value applied to, or by, a participant to a set of counterparties. The multilateral limit is taken into account by the transaction administrator to contain the risk in the system. With the help of the multilateral limit, the direct participant restricts the use of liquidity when clearing payments with all other direct participants for which no bilateral limit is set Validation: [1..1]
</Tp>		End of Limit Type Mandatory	End of Limit Type Validation: [1..1]
<AcctOwnr>		Account Owner Optional A2A	Validation: [0..1]
<FinInstnId>		Financial Institution Identification Mandatory	Financial Institution Identification Validation: [1..1]
<BICFI>-</BICFI>	4!a2!a2!c3!c	BICFIIdentifier Optional	BICFIIdentifier Interfaced models = BIC of the Settlement Bank Real Time models = Not used BIC of the RTGS main account / in case of group of accounts BIC of the leading account of the group BIC of the RTGS main account / in case of group of accounts BIC of the leading account of the group Validation: [0..1] In the case of "on behalf" scenario (sending party not Account Owner) mandatory. When not stated the BIC

name of attribute	format	short description	description
			of the participant is used. Usage of AccountOwner is only allowed once per request.
</FinInstnId>		End of Financial Institution Identification Mandatory	End of Financial Institution Identification Validation: [1..1]
</AcctOwnr>		End of Account owner Optional	Validation: [0..1]
</AllCurLmts>		End of Identification of the current limit. Mandatory	Validation: [1..1]
/xorCurLmtIdAllCurLmts		End choice amongst Mandatory	Validation:
</LmtDtls>		End Limit Details Mandatory	Validation: [1..1]
</DelLmt>		End of Messagename for DeleteLimit Mandatory A2A	Validation: [1..1]

Error Codes:

Order	Error code				Error Text / Validation/ Remark
	SSP	Y-copy	V-shape	XML	
1	X00			0000	<p>Error Text: O.k.</p> <p>Validation: Confirmation, that a task is stored in the task queue. A related reference for the subsequent processing (e.g. confirmation) of the task is returned.</p> <p>Remark: Receipt (status code)</p>
2	X44			1404	<p>Error Text: If "non repudiation of emission" is mandatory, the NRE indicator flag has to be present</p> <p>Validation: When non-repudiaton processing is mandatory, the tag If non-repudiaton processing is mandatory, the tag <SwInt:NRIndicator>TRUE</SwInt:NRIndicator> has to be present.</p> <p>Remark: checked by ICM / Receipt</p>
3	X41			1401	<p>Error Text: No permission. RBAC User role(s) are not sufficient.</p> <p>Validation: RBAC role name "APPLICATE" or "APPLICBTE" are required</p> <p>Remark: checked by ICM / Receipt</p>
4	X42			1402	<p>Error Text: No authorisation. User is not allowed acting on behalf of another participant.</p> <p>Validation: AcctOwnr (profile credit institution), value must indicate the participant itself or a participant the CI is entitled to act on behalf of</p> <p>Remark: checked by ICM / Receipt</p>
5	X45			1405	<p>Error Text: No authorisation or rather interaction not possible. User is not allowed acting on behalf of another participant as Group of Account manager</p> <p>Validation: AcctOwnr (profile group of account manager) value must indicate the group of account manager</p> <p>Remark: checked by ICM / Receipt</p>
6	X47			1407	<p>Error Text: No authorisation. User is not allowed acting on behalf of another Participant as Central Bank</p> <p>Validation: AcctOwnr (profile central bank), value must indicate the CB itself or a participant the CB is responsible for</p> <p>Remark: checked by ICM / Receipt</p>
7	X48			1408	<p>Error Text: Interaction only possible for the virtual account manager</p> <p>Validation: change of limits for group of accounts is only possible by "Virtual account" manager</p> <p>Remark: checked by ICM / Receipt</p>
8	P51			P051	<p>Error Text: BIC Bilateral Counterpart does not exist</p> <p>Validation: BilLmtCtrPtyId/FinInstnId/BICFI BIC of the RTGS main account must be valid and indicate a SSP participant</p> <p>Remark: checked by ICM / Receipt</p>
9	X40			1400	<p>Error Text: BIC must indicate a SSP participant</p> <p>Validation: BIC must indicate a SSP participant</p> <p>Remark: checked by ICM / Receipt</p>
10	P12			P012	<p>Error Text: Modification, setting or deletion of limits not possible</p> <p>Validation: BilLmtCtrPtyId/FinInstnId/BICFI must not indicate the participant itself, self-addressed bilateral limit is not allowed,</p> <p>Remark: checked by ICM / Receipt</p>
11	862	C2	TM01	2862	<p>Error Text: Request out of cut-off time</p> <p>Validation: Possibility to use this function during the current phase of</p>

Order	Error code				Error Text / Validation/ Remark
	SSP	Y-copy	V-shape	XML	
					business day. Remark: checked by PM / TaskQueue
12	866	C6	AC06	2866	Error Text: Exclusion of participant Validation: If requestor is direct participant or ancillary system or GoA manager and this requestor is excluded, no change of data is allowed Remark: checked by PM/ TaskQueue
13	P14			P014	Error Text: No Limit found Validation: it's not allowed to define a multilateral limit for the current day, if no multilateral limit exists. Remark: checked by PM/ TaskQueue
14	894	K4		2894	Error Text: Function is not allowed in the current business day phase Validation: SSP is open Remark: checked by PM/ TaskQueue
15	P15			P015	Error Text: No bilateral limit defined for Counter Party Validation: Existing bilateral Limit for <BilLmtCtrPtyId> Remark: checked by PM/ TaskQueue
17	P51			P051	Error Text: BIC Bilateral Counterpart does not exist Validation: Bilateral counterparty is a Participant with account Remark: checked by PM/ TaskQueue
18	P12			P012	Error Text: Modification, setting or deletion of limits not possible Validation: bilateral limit against accounts without non-liability of cover is not allowed Remark: checked by PM/ TaskQueue
19	P15			P015	Error Text: No bilateral limit defined for Counter Party Validation: it's not allowed to define a bilateral limit for the current day, if no bilateral limit exists Remark: checked by PM/ TaskQueue
20	P30			P030	Error Text: Only one occurrence of the element <AcctOwnr> per message is allowed. Validation: If element <AcctOwnr> is used it may only occur once. Remark: checked by ICM / Receipt
21	P31			P031	Error Text: The modification or removal of a multilateral limit is allowed only once per message. Validation: The modification or removal of a multilateral limit may be requested only once per request. If type "MULT" occurs more than once an error message will be returned. Remark: checked by ICM / Receipt
22	P32			P032	Error Text: The same counterpart-BIC is only allowed not more than once per message. Validation: For deletion of several bilateral limits: The same counterpart-BIC is only allowed not more than once to have a unique reference within the Receipt message. Remark: checked by ICM / Receipt

DeleteLimit_PM_1

Scope: Delete Bilateral Limit against Counterpart <BilLmtCtrPtyId>

MessageName for DeleteLimit	<DelLmt>
Message Header	<MsgHdr>
Message Identification	<MsgId>ABC123</MsgId>
End of Message Header	</MsgHdr>
LimitDetails	<LmtDtls>
Current Limit Identification	<CurLmtId>
BilateralLimitCounterpartyId	<BilLmtCtrPtyId>
BICFIIdentifier	<BICFI>DRESDEFFXX</BICFI>
End of BilateralLimitCounterpartyId	</BilLmtCtrPtyId>
Limit Type	<Tp>
Limit Type Code	<Cd>BILI</Cd>
End of Limit Type	</Tp>
End of CurrentLimitIdentification	</CurLmtId>
End Limit Details	</LmtDtls>
End of MessageName for DeleteLimit	</DeLmt>

DeleteLimit_PM_2

Scope: Delete Bilateral Limit against Counterpart <BilLmtCtrPtyId> on behalf of third party <AcctOwnr>, (Sender and Account Owner are different parties), CB deletes a bilateral limit instead of "COBADEFFXXX".

MessageName for DeleteLimit	<DelLmt>
Message Header	<MsgHdr>
Message Identification	<MsgId>ABC123</MsgId>
End of Message Header	</MsgHdr>
LimitDetails	<LmtDtls>
Current Limit Identification	<CurLmtId>
BilateralLimitCounterpartyId	<BilLmtCtrPtyId>
Financial Institution Identification	<FinInstnId>
BICFIIdentifier	<BICFI>DEUTDEFFXXX</BICFI>
End of Financial Institution Identification	</FinInstnId>
End of BilateralLimitCounterpartyId	</BilLmtCtrPtyId>
Limit Type	<Tp>
Limit Type Code	<Cd>BILI</Cd>
End of Limit Type	</Tp>
End of CurrentLimitIdentification	</CurLmtId>
Account Owner	<AcctOwnr>
Financial Institution Identification	<FinInstnId>
BICFIIdentifier	<BICFI>COBADEFFXXX</BICFI>
End of Financial Institution Identification	</FinInstnId>
End of Account owner	</AcctOwnr>
End Limit Details	</LmtDtls>
End of MessageName for DeleteLimit	</DelLmt>

DeleteLimit_PM_3

Scope: Delete Multilateral Limit of a RTGS main Account (Sender and Account Owner are identic)

Messagename for DeleteLimit	<DelLmt>
Message Header	<MsgHdr>
Message Identification	<MsgId>ABC123</MsgId>
End of Message Header	</MsgHdr>
LimitDetails	<LmtDtIs>
Current Limit Identification	<CurLmtId>
Limit Type	<Tp>
Limit Type Code	<Cd>MULT</Cd>
End of Limit Type	</Tp>
End of CurrentLimitIdentification	</CurLmtId>
End Limit Details	</LmtDtIs>
End of Messagename for DeleteLimit	</DelLmt>

DeleteLimit_PM_4

Scope: The requestor deletes all bilateral limits

Messagenname for DeleteLimit	<DelLmt>
Message Header	<MsgHdr>
Message Identification	<MsgId>ABC123</MsgId>
End of Message Header	</MsgHdr>
LimitDetails	<LmtDtls>
Identification of the current limit.	<AllCurLmts>
Limit Type	<Tp>
Limit Type Code	<Cd>BILI</Cd>
End of Limit Type	</Tp>
End of Identification of the current limit.	</AllCurLmts>
End Limit Details	</LmtDtls>
End of Messagenname for DeleteLimit	</DelLmt>

6. 4. 5 DeleteReservation

Cash Management Standard

DeleteReservation_PM

Scope: The DeleteReservation message is used to delete a valid

- current urgent or highly urgent reservation

The DeleteReservation message can be sent by the application of a direct PM participant or the application of a group of accounts manager ("virtual account" reservation of liquidity possible for the whole group only, not for the single account holder).

If a participant is a member of an account group, the limit can only be defined against the whole group. Therefore limits that are defined against an account group have to be defined against the account owner (BIC) of the leading account of the group.

The DeleteReservation message is replied by a Receipt message.
Non-Repudiation of Emission (NRE) is supported.

<camt.049.001.xx>

Structure:

message name for DeleteReservation	<DelRsvatn>
Message Header	<MsgHdr>
Message Identification	<MsgId></MsgId>
End of Message Header	</MsgHdr>
CurrentReservation	<CurRsvatn>
ReservationType	<Tp>
ReservationTypeCode	<Cd></Cd>
End of ReservationType	</Tp>
Account Owner	<AcctOwnr>
Financial Institution Identification	<FinInstnId>
BICFIIdentifier	<BICFI></BICFI>
End of Financial Institution Identification	</FinInstnId>
End of Account owner	</AcctOwnr>
End of CurrentReservation	</CurRsvatn>
End of message name for DeleteReservation	</DelRsvatn>

Attributes:

name of attribute	format	short description	description
<DelRsvatn>		message name for DeleteReservation Mandatory A2A	message name for DeleteReservation Validation:
<MsgHdr>		Message Header Mandatory A2A	Set of characteristics specific to the message Validation: [1..1]
<MsgId>-</MsgId>	35x	Message Identification Mandatory A2A	Message Identification Validation: [1..1]
</MsgHdr>		End of Message Header Mandatory A2A	Validation: [1..1]
<CurRsvatn>		CurrentReservation Mandatory A2A	CurrentReservation Validation: ****[1..1]in PM mandatory differs from the cash management standard only one occurrence is used, <AcctId> not used in PM
<Tp>		ReservationType Mandatory A2A	ReservationType Validation: [1..1] in PM only UPAR and HPAR are used
<Cd>-</Cd>		ReservationTypeCode Mandatory	ReservationTypeCode SSP restricted code list: UPAR = UrgentPaymentReservation Amount set aside by a participant to reserve liquidity from its own account, exclusively for executing urgent payments. HPAR = HighlyUrgentPayment reservation Amount set aside by a participant to reserve liquidity from its own account, exclusively for executing highly urgent payment Validation: [1..1]
</Tp>		End of ReservationType Mandatory	End of ReservationType Validation: [1..1]
<AcctOwnr>		Account Owner Optional A2A	Validation: [0..1]
<FinInstnId>		Financial Institution Identification Mandatory	Financial Institution Identification Validation: [1..1]
<BICFI>-</BICFI>	4!a2!a2!c3!c	BICFIIdentifier	BICFIIdentifier BIC of the RTGS main account / in case of group of

name of attribute	format	short description	description
		Optional	accounts BIC of the leading account of the group Validation: [0..1]mandatory if BIC of RTGS main account is used on behalf of third parties, when not stated the BIC of the participant is used
</FinInstnId>		End of Financial Institution Identification Mandatory	End of Financial Institution Identification Validation: [1..1]
</AcctOwnr>		End of Account owner Optional	Validation:
</CurRsvatn>		End of CurrentReservation Mandatory A2A	End of CurrentReservation Validation: [1..1]
</DelRsvatn>		End of message name for DeleteReservation Mandatory A2A	end of message name for DeleteReservation Validation:

Error Codes:

Order	Error code				Error Text / Validation/ Remark
	SSP	Y-copy	V-shape	XML	
1	X00			0000	<p>Error Text: O.k.</p> <p>Validation: Confirmation, that a task is stored in the task queue. A related reference for the subsequent processing (e.g. confirmation) of the task is returned.</p> <p>Remark: Receipt (status code)</p>
2	X44			1404	<p>Error Text: If "non repudiation of emission" is mandatory, the NRE indicator flag has to be present</p> <p>Validation: If non-repudiaton processing is mandatory, the tag <SwInt:NRIndicator>TRUE</SwInt:NRIndicator> has to be present.</p> <p>Remark: checked by ICM / Receipt</p>
3	X41			1401	<p>Error Text: No permission. RBAC User role(s) are not sufficient.</p> <p>Validation: RBAC role name "APPLICATE" or "APPLICBTE" are required</p> <p>Remark: checked by ICM / Receipt</p>
4	X42			1402	<p>Error Text: No authorisation. User is not allowed acting on behalf of another participant.</p> <p>Validation: AcctOwnr (profile credit institution), value must indicate the participant itself or a participant the CI is entitled to act on behalf of</p> <p>Remark: checked by ICM / Receipt</p>
5	X45			1405	<p>Error Text: No authorisation or rather interaction not possible. User is not allowed acting on behalf of another participant as Group of Account manager</p> <p>Validation: AcctOwnr (profile group of account manager) value must indicate the group of account manager</p> <p>Remark: checked by ICM / Receipt</p>
6	X47			1407	<p>Error Text: No authorisation. User is not allowed acting on behalf of another Participant as Central Bank</p> <p>Validation: AcctOwnr (profile central bank), value must indicate the CB itself or a participant the CB is responsible for</p> <p>Remark: checked by ICM / Receipt</p>
7	X48			1408	<p>Error Text: Interaction only possible for the virtual account manager</p> <p>Validation: Reservation of liquidity only possible for the Virtual account manager, for single account holders not possible</p> <p>Remark: checked by ICM / Receipt</p>
8	894	K4		2894	<p>Error Text: Function is not allowed in the current business day phase</p> <p>Validation: SSP is open</p> <p>Remark: checked by PM/ TaskQueue</p>
9	862	C2	TM01	2862	<p>Error Text: Request out of cut-off time</p> <p>Validation: Possibility to use this function during the current phase of business day.</p> <p>Remark: checked by PM / ReturnTask</p>
10	866	C6	AC06	2866	<p>Error Text: Exclusion of participant</p> <p>Validation: If requestor is direct participant or ancillary system or GoA manager and this requestor is excluded, no change of data is allowed</p> <p>Remark: checked by PM/ TaskQueue</p>
11	X40			1400	<p>Error Text: BIC must indicate a SSP participant</p> <p>Validation: BIC must indicate a SSP participant</p>

Order	Error code				Error Text / Validation/ Remark
	SSP	Y-copy	V-shape	XML	

Remark: checked by PM/ TaskQueue

12	P16	P016	Error Text: No current Reservation found Validation: existing current reservation Remark: checked by PM/ TaskQueue
----	-----	------	---

13	P61	P061	Error Text: For accounts without non-liability of cover, this function is not allowed Validation: For accounts without non-liability of cover, liquidity reservation are not allowed Remark: checked by PM/ TaskQueue
----	-----	------	--

DeleteReservation_PM_1

Scope: Delete current reservations for urgent payments. Sending party and Account Owner (SSP-Participant) are identic

message name for DeleteReservation	<DelRsvatn>
Message Header	<MsgHdr>
Message Identification	<MsgId>ABC123</MsgId>
End of Message Header	</MsgHdr>
CurrentReservation	<CurRsvatn>
ReservationType	<Tp>
ReservationTypeCode	<Cd>UPAR</Cd>
End of ReservationType	</Tp>
End of CurrentReservation	</CurRsvatn>
End of message name for DeleteReservation	</DelRsvatn>

DeleteReservation_PM_2

Scope: Delete current reservation for highly urgent payments. Act on behalf of scenario, Sending party and Account Owner are different

message name for DeleteReservation	<DelRsvatn>
Message Header	<MsgHdr>
Message Identification	<MsgId>ABC123</MsgId>
End of Message Header	</MsgHdr>
CurrentReservation	<CurRsvatn>
ReservationType	<Tp>
ReservationTypeCode	<Cd>HPAR</Cd>
End of ReservationType	</Tp>
Account Owner	<AcctOwnr>
Financial Institution Identification	<FinInstnId>
BICFIIdentifier	<BICFI>DEUTDEFFXXX</BICFI>
End of Financial Institution Identification	</FinInstnId>
End of Account owner	</AcctOwnr>
End of CurrentReservation	</CurRsvatn>
End of message name for DeleteReservation	</DelRsvatn>

6. 4. 6 GetAccount

Cash Management Standard

GetAccount_PM

Scope: The GetAccount message is sent to request information about the
 - balance on the following accounts kept in PM
 - RTGS account.
 - sub-account.

The GetAccount message can be sent by the application of the
 - direct PM participant
 - group of accounts manager
 - CB

The GetAccount message is replied by a ReturnAccount message.

<camt.003.001.xx>

Structure:

Message Type	<GetAcct>
Message Header	<MsgHdr>
Message Identification	<MsgId></MsgId>
End of Message Header	</MsgHdr>
Account Query Definition	<AcctQryDef>
AccountCriteria	<AcctCrit>
NewCriteria	<NewCrit>
SearchCriteria	<SchCrit>
Choice	xorAcctIdAcctOwnr
Account Identification	<AcctId>
AccountIdentificationChoice	<EQ>
GenericAccountIdentification	<Othr>
Identification	<Id></Id>
End of GenericAccountIdentification	</Othr>
End of AccountIdentificationChoice	</EQ>
End of Account Identification	</AcctId>
Account Owner	<AcctOwnr>
Identification	<Id>
OrganisationIdentification	<OrgId>
AnyBICIdentifier	<AnyBIC></AnyBIC>
End of OrganisationIdentification	</OrgId>
End Identification	</Id>
End of Account owner	</AcctOwnr>
End of Choice	/xorAcctIdAcctOwnr
End of SearchCriteria	</SchCrit>
End of NewCriteria	</NewCrit>
End of AccountCriteria	</AcctCrit>
End of AccountQueryDefinition	</AcctQryDef>
End of Message Type	</GetAcct>

Attributes:

name of attribute	format	short description	description
<GetAcct>		Message Type	Message name for GetAccount
		Mandatory	Validation:
<MsgHdr>		Message Header	Set of characteristics specific to the message
		Mandatory	Validation:
		A2A	[1..1]
<MsgId>-</MsgId>	35x	Message Identification	Message Identification
		Mandatory	Validation:
		A2A	[1..1]
</MsgHdr>		End of Message Header	
		Mandatory	Validation:
		A2A	[1..1]
<AcctQryDef>		Account Query Definition	Specification of the query criteria.
		Optional	Validation:
		A2A	[0..1] In PM only <AcctCrit> is used
<AcctCrit>		AccountCriteria	Definition of the account query criteria.
		Optional	Validation:
		A2A	[0..1]
<NewCrit>		NewCriteria	Defines the criteria based on which the information is extracted.
		Mandatory	Validation:
		A2A	[1..1] <NewQryNm> and <RtrCrit> are not used in PM
<SchCrit>		SearchCriteria	Defines the criteria used to search for.
		Optional	Validation:
		A2A	*****[0..1] differs from the cash management standard all possible balances are returned within the ReturnAccount message. Balance for Group of Account can only be received by single Requests for each account belonging to a Group of Account and calculation on customer side. *****Rule: It should only be possible to choice amongst <AcctId> or <AcctOwnr>, both tags are not allowed.
xorAcctIdAcctOwnr		Choice	Choice between AccountIdentification and AccountOwner
		Optional	Validation:
			*****[0..1] differs from the Cash Management Standard. There is no choice in the standard. All child elements of SearchCriteria are optional but do not exclude each other.
<AcctId>		Account Identification	Unique and unambiguous identification for the account between the account owner and the account servicer.
		Mandatory	Validation:
		A2A	*****[1..1] differs from the cash management standard In PM only EQ with <DmstAcct><Id> is used. - Field has to be filled with a valid sub-account ID
<EQ>		AccountIdentificationChoice	Search for one or more accounts based on exact

name of attribute	format	short description	description
			identification of the account(s).
		Mandatory A2A	Validation: [1..1]
<Othr>		GenericAccountIdentification Mandatory A2A	GenericAccountIdentification Validation: [1..1]
<Id>-</Id>	34x	Identification Mandatory A2A	Name or number assigned by an entity to enable recognition of that entity, eg, account identifier. RTGS sub-account number. If not stated the RTGS main account information is called up. Validation: [1..1] only used if balance of a specific RTGS sub-account is (34x) requested
</Othr>		End of GenericAccountIdentification Mandatory A2A	End of GenericAccountIdentification Validation: [1..1]
</EQ>		End of AccountIdentificationChoice Mandatory A2A	End of search for one or more accounts based on exact identification of the account(s). Validation: [1..1]
</AcctId>		End of Account Identification Mandatory A2A	Unique and unambiguous identification for the account between the account owner and the account servicer. Validation: *****[1..1]
<AcctOwnc>		Account Owner Mandatory A2A	Validation: *****[1..1]
<Id>		Identification Mandatory	Identification Validation: *****[1..1]
<OrgId>		OrganisationIdentification Mandatory	OrganisationIdentification Validation: [1..1]
<AnyBIC>-</AnyBIC>	4!a2!a2!c[3!cAnyBICIdentifier]	Mandatory	AnyBICIdentifier / BIC used on behalf of third parties BIC of the RTGS main account / SSP-Participant Validation: *****[1..1] - In case the requestor is a normal CI, his DN must match to the stated BIC. - If requestor is a GoA manager, the mentioned BIC must be his own or a group member's BIC. - A CB may only select accounts she is responsible for.
</OrgId>		End of OrganisationIdentification Mandatory	End of OrganisationIdentification Validation:

name of attribute	format	short description	description
			[1..1]
</ld>		End Identification Mandatory	Validation: ****[1..1]
</AcctOwnr>		End of Account owner Mandatory	Validation: ****[1..1]
/xorAcctldAcctOwnr		End of Choice Optional	End of choice between AccountIdentification and AccountOwner Validation: ****[0..1]
</SchCrit>		End of SearchCriteria Optional A2A	End of SearchCriteria Validation: ****[0..1]
</NewCrit>		End of NewCriteria Mandatory A2A	End of NewCriteria Validation: [1..1]
</AcctCrit>		End of AccountCriteria Optional A2A	End of AccountCriteria Validation: [0..1]
</AcctQryDef>		End of AccountQueryDefinition Optional A2A	End of AccountQueryDefinition Validation: [0..1]
</GetAcct>		End of Message Type Mandatory A2A	End of GetAccount Validation:

Error Codes:

Order	Error code				Error Text / Validation/ Remark
	SSP	Y-copy	V-shape	XML	
1	X41			1401	Error Text: No permission. RBAC User role(s) are not sufficient. Validation: RBAC role name "APPLICATE", "APPLICBTE", "APPLICSTE" or "APPLIASTE" are required. Remark: checked by ICM / Receipt
2	X47			1407	Error Text: No authorisation. User is not allowed acting on behalf of another Participant as Central Bank Validation: AcctOwnr (profile central bank) value must indicate an account that belongs to the CB itself or to a participant the CB is responsible for Remark: checked by ICM/ ReturnAccount
3	X45			1405	Error Text: No authorisation or rather interaction not possible. User is not allowed acting on behalf of another participant as Group of Account manager Validation: AcctOwnr (profile group of account manager) value must indicate a member of the group of accounts the participant is the manager of Remark: checked by ICM/ ReturnAccount
4	X42			1402	Error Text: No authorisation. User is not allowed acting on behalf of another participant. Validation: AcctOwnr (profile credit institution) value must indicate an account that belongs to the credit institution itself or to the participant the credit institution is entitled to act on behalf of Remark: checked by ICM/ ReturnAccount
5	X45			1405	Error Text: No authorisation or rather interaction not possible. User is not allowed acting on behalf of another participant as Group of Account manager Validation: DmstAcct/Id (profile group of account manager) value must indicate a member of the group of accounts the participant is the manager of Remark: checked by ICM/ ReturnAccount
6	X47			1407	Error Text: No authorisation. User is not allowed acting on behalf of another Participant as Central Bank Validation: DmstAcct/Id (profile central bank) value must indicate an account that belongs to the CB itself or to a participant the CB is responsible for Remark: checked by ICM/ ReturnAccount
7	X42			1402	Error Text: No authorisation. User is not allowed acting on behalf of another participant. Validation: DmstAcct/Id (profile credit institution) value must indicate an account that belongs to the credit institution itself or to the participant the credit institution is entitled to act on behalf of Remark: checked by ICM/ ReturnAccount
8	X40			1400	Error Text: BIC must indicate a SSP participant Validation: BIC must indicate a SSP participant Remark: checked by ICM/ ReturnAccount
9	P55			P055	Error Text: Account does not exist or is invalid Validation: DmstAcct/Id value must indicate an existing sub account Remark: checked by ICM/ ReturnAccount
10	894	K4		2894	Error Text: Function is not allowed in the current business day phase Validation: SSP is open Remark: checked by PM/ ReturnAccount

Order	Error code				Error Text / Validation/ Remark
	SSP	Y-copy	V-shape	XML	

11	862	C2	TM01	2862	<p>Error Text: Request out of cut-off time</p> <p>Validation: Possibility to use this function during the current phase of business day.</p> <p>Remark: checked by PM / ReturnAccount</p>
----	-----	----	------	------	--

GetAccount_PM_1

Scope: Request balance. Sending party and Account Owner are identical.

Message Type	<GetAcct>
Message Header	<MsgHdr>
Message Identification	<MsgId>abc123</MsgId>
End of Message Header	</MsgHdr>
End of Message Type	</GetAcct>

GetAccount_PM_2

Scope: Request balance for specific sub-account.

Message Type	<GetAcct>
Message Header	<MsgHdr>
Message Identification	<MsgId>ABC123</MsgId>
End of Message Header	</MsgHdr>
Account Query Definition	<AcctQryDef>
AccountCriteria	<AcctCrit>
NewCriteria	<NewCrit>
SearchCriteria	<SchCrit>
Account Identification	<AcctId>
AccountIdentificationChoice	<EQ>
GenericAccountIdentification	<DmstAcct>
Identification	<Id>BE67123456789122345678</Id>
End of GenericAccountIdentification	</DmstAcct>
End of AccountIdentificationChoice	</EQ>
End of Account Identification	</AcctId>
End of SearchCriteria	</SchCrit>
End of NewCriteria	</NewCrit>
End of AccountCriteria	</AcctCrit>
End of AccountQueryDefinition	</AcctQryDef>
End of Message Type	</GetAcct>

GetAccount_PM_3

Scope: Request on behalf of third party (AccountOwner) e.g. BIC of NCB or GoA manager is the Sender of the GetAccount message. Sending party and AccountOwner are different

Message Type	<GetAcct>
Message Header	<MsgHdr>
Message Identification	<MsgId>ABC123</MsgId>
End of Message Header	</MsgHdr>
Account Query Definition	<AcctQryDef>
AccountCriteria	<AcctCrit>
NewCriteria	<NewCrit>
SearchCriteria	<SchCrit>
Account Owner	<AcctOwnr>
Identification	<Id>
OrganisationIdentification	<OrgId>
AnyBICIdentifier	<AnyBIC>DRESDEFF</AnyBIC>
End of OrganisationIdentification	</OrgId>
End Identification	</Id>
End of Account owner	</AcctOwnr>
End of SearchCriteria	</SchCrit>
End of NewCriteria	</NewCrit>
End of AccountCriteria	</AcctCrit>
End of AccountQueryDefinition	</AcctQryDef>
End of Message Type	</GetAcct>

6. 4. 7 GetBusinessDayInformation

Cash Management Standard

GetBusinessDayInformation_PM

Scope: The GetBusinessDayInformation message is sent to request information on SSP event times of the current business day.(E.g. Cutt-off times)

The GetBusinessDayInformation message can be sent by the application of the direct PM participant.

The GetBusinessDayInformation message is replied by a ReturnBusinessDayInformation message.

<camt.018.001.xx>

Structure:

Message name for GetBusinessDayInformation	<GetBizDayInf>
Message Header	<MsgHdr>
Message Identification	<MsgId></MsgId>
End of Message Header	</MsgHdr>
End of Message name for GetBusinessDayInformation	</GetBizDayInf>

Attributes:

name of attribute	format	short description	description
<GetBizDayInf>		Message name for GetBusinessDayInformation Mandatory A2A	Message name for GetBusinessDayInformation Validation:
<MsgHdr>		Message Header Mandatory A2A	Set of characteristics specific to the message Validation: [1..1]
<MsgId>--</MsgId>	35x	Message Identification Mandatory A2A	Message Identification Validation: [1..1]
</MsgHdr>		End of Message Header Mandatory A2A	Validation: [1..1]
</GetBizDayInf>		End of Message name for GetBusinessDayInformation Mandatory A2A	Validation:

Error Codes:

Order	Error code				Error Text / Validation/ Remark
	SSP	Y-copy	V-shape	XML	
1	X41			1401	Error Text: No permission. RBAC User role(s) are not sufficient. Validation: RBAC role name "APPLICATE", "APPLICBTE", "APPLICSTE" or "APPLIASTE" are required. Remark: checked by ICM / ReturnBusinessDayInformation
2	P18			P018	Error Text: No Business Day Data found Validation: available information of SSP-Business Day Remark: ReturnBusinessDayInformation
3	862	C2	TM01	2862	Error Text: Request out of cut-off time Validation: Possibility to use this function during the current phase of business day. Remark: checked by PM / ReturnBusinessDayInformation

GetBusinessDayInformation_PM_1

Scope: Only one sample possible, Request to get information about Country Status in SSP and the current Operating day

Message name for GetBusinessDayInformation	<GetBizDayInf>
Message Header	<MsgHdr>
Message Identification	<MsgId>ABC123</MsgId>
End of Message Header	</MsgHdr>
End of Message name for GetBusinessDayInformation	</GetBizDayInf>

6. 4. 8 GetCreditLine

SSP Proprietary Messages

GetCreditLine_PM

Scope: The GetCreditLine message is used to receive information on the credit line currently available on the RTGS main account.

The GetCreditLine message can be sent by the application of

- a direct PM participant,
- a Group of Accounts manager or
- a CB.

The GetCreditLine message is replied by a ReturnCreditLine message.

<camt.998.001.xx>

Structure:

Name Proprietary message	<PrtryMsg>
Message Header	<MsgHdr>
Message Identification	<MsgId></MsgId>
End of Message Header	</MsgHdr>
Proprietary Data	<PrtryData>
Proprietary Data type	<Tp>GetCreditLine</Tp>
Proprietary Data	<Data>
SSP Proprietary Data	<SspPrtryDt>
CreditLineQueryDefinition	<CrdtLnQryDef>
CreditLineCriteriaDefinition	<CrdtLnCrit>
NewCriteria	<NewCrit>
SearchCriteria	<SchCrit>
Account Owner	<AcctOwnr></AcctOwnr>
End of SearchCriteria	</SchCrit>
End of NewCriteria	</NewCrit>
End of CreditLineCriteriaDefinition	</CrdtLnCrit>
End of CreditLineQueryDefinition	</CrdtLnQryDef>
End of SSP Proprietary Data	</SspPrtryDt>
End of Proprietary Data	</Data>
End of Proprietary Data	</PrtryData>
End proprietary message	</PrtryMsg>

Attributes:

name of attribute	format	short description	description
<PrtryMsg>		Name Proprietary message Mandatory A2A	Validation:
<MsgHdr>		Message Header Mandatory A2A	Set of characteristics specific to the message Message Reference Validation: [1..1]
<MsgId>-</MsgId>	35x	Message Identification Mandatory A2A	Message Identification Validation: [1..1]
</MsgHdr>		End of Message Header Mandatory A2A	Validation: [1..1]
<PrtryData>		Proprietary Data Mandatory A2A	Proprietary Data Validation: [1..1]
<Tp>-</Tp>		Proprietary Data type Mandatory A2A	Proprietary Data type here only GetCreditLine is possible Validation: [1..1]
<Data>		Proprietary Data Mandatory	Proprietary data content Validation: [1..1]
<SspPrtryDt>		SSP Proprietary Data Mandatory A2A	Root element for all SSP proprietary data Validation: [1..1]
<CrdtLnQryDef>		CreditLineQueryDefinition Optional A2A	CreditLineQueryDefinition Validation: [0..1]
<CrdtLnCrit>		CreditLineCriteriaDefinition Optional A2A	CreditLineCriteriaDefinition Validation: [0..1]
<NewCrit>		NewCriteria Mandatory A2A	Defines the criteria based on which the information is extracted. Validation: [1..1]
<SchCrit>		SearchCriteria Optional A2A	Defines the criteria used to search for. Validation: [0..1]
<AcctOwnr>-</AcctOwnr>	11x	Account Owner	BICIdentifier

name of attribute	format	short description	description
			e.g. needed on behalf of third parties if e. g. the NCB are able to start several transactions on behalf their national banking community. BIC of the RTGS main account / SSP-Participant When not stated the BIC matching to the requestor DN is used.
		Optional A2A	Validation: [0..1] - In case the requestor is a normal CI, his DN must match to the stated BIC. - If requestor is a GoA manager, the mentioned BIC must be his own or a group member's BIC. - A CB may only select accounts she is responsible for.
</SchCrit>		End of SearchCriteria Optional A2A	End of SearchCriteria Validation: [0..1]
</NewCrit>		End of NewCriteria Mandatory A2A	End of NewCriteria Validation: [1..1]
</CrdtLnCrit>		End of CreditLineCriteriaDefinition Optional A2A	end of CreditLineCriteriaDefinition Validation: [0..1]
</CrdtLnQryDef>		End of CreditLineQueryDefinition Optional A2A	end of CreditLineQueryDefinition Validation: [0..1]
</SspPrtryDt>		End of SSP Proprietary Data Mandatory A2A	End of Root element for all SSP proprietary data Validation: [1..1]
</Data>		End of Proprietary Data Mandatory	Validation: [1..1]
</PrtryData>		End of Proprietary Data Mandatory A2A	End of Proprietary Data Validation: [1..1]
</PrtryMsg>		End proprietary message Mandatory A2A	Validation:

Error Codes:

Order	Error code				Error Text / Validation/ Remark
	SSP	Y-copy	V-shape	XML	
1	X41			1401	Error Text: No permission. RBAC User role(s) are not sufficient. Validation: RBAC role name "APPLICATE", "APPLICSTE" or "APPLICBTE" are required Remark: checked by ICM / ReturnCreditLine
2	X42			1402	Error Text: No authorisation. User is not allowed acting on behalf of another participant. Validation: AcctOwnr (profile credit institution) value must indicate the credit institution itself or a participant the credit institution is entitled to act on behalf of Remark: checked by ICM / ReturnCreditLine
3	X47			1407	Error Text: No authorisation. User is not allowed acting on behalf of another Participant as Central Bank Validation: AcctOwnr (profile central bank) value must indicate the central bank itself or a participant the central bank is entitled to act on behalf of Remark: checked by ICM / ReturnCreditLine
4	X45			1405	Error Text: No authorisation or rather interaction not possible. User is not allowed acting on behalf of another participant as Group of Account manager Validation: AcctOwnr (profile group of account manager) value must indicate a member of the group of accounts the participant is the manager of Remark: checked by ICM / ReturnCreditLine
5	X40			1400	Error Text: BIC must indicate a SSP participant Validation: BIC must indicate a SSP participant Remark: checked by ICM / ReturnCreditLine
6	862	C2	TM01	2862	Error Text: Request out of cut-off time Validation: Possibility to use this function during the current phase of business day. Remark: checked by PM / ReturnCreditLine

GetCreditLine_PM_1

Scope: GetCreditLine request Sending party and AccountOwner are identic

Name Proprietary message	<PrtryMsg>
Message Header	<MsgHdr>
Message Identification	<MsgId>ABC123</MsgId>
End of Message Header	</MsgHdr>
Proprietary Data	<PrtryData>
Proprietary Data type	<Tp>GetCreditLine</Tp>
Proprietary Data	<Data>
SSP Proprietary Data	<SspPrtryDt>
CreditLineQueryDefinition	<CrdtLnQryDef>
CreditLineCriteriaDefinition	<CrdtLnCrit>
NewCriteria	<NewCrit>
SearchCriteria	<SchCrit/>
End of NewCriteria	</NewCrit>
End of CreditLineCriteriaDefinition	</CrdtLnCrit>
End of CreditLineQueryDefinition	</CrdtLnQryDef>
End of SSP Proprietary Data	</SspPrtryDt>
End of Proprietary Data	</Data>
End of Proprietary Data	</PrtryData>
End proprietary message	</PrtryMsg>

GetCreditLine_PM_2

Scope: GetCreditLine request on behalf of third party (AccountOwner). Sending party and Account Owner are different.

Name Proprietary message	<PrtryMsg>
Message Header	<MsgHdr>
Message Identification	<MsgId>ABC123</MsgId>
End of Message Header	</MsgHdr>
Proprietary Data	<PrtryData>
Proprietary Data type	<Tp>GetCreditLine</Tp>
Proprietary Data	<Data>
SSP Proprietary Data	<SspPrtryDt>
CreditLineQueryDefinition	<CrdtLnQryDef>
CreditLineCriteriaDefinition	<CrdtLnCrit>
NewCriteria	<NewCrit>
SearchCriteria	<SchCrit>
Account Owner	<AcctOwnr>DRESDEFF</AcctOwnr>
End of SearchCriteria	</SchCrit>
End of NewCriteria	</NewCrit>
End of CreditLineCriteriaDefinition	</CrdtLnCrit>
End of CreditLineQueryDefinition	</CrdtLnQryDef>
End of SSP Proprietary Data	</SspPrtryDt>
End of Proprietary Data	</Data>
End of Proprietary Data	</PrtryData>
End proprietary message	</PrtryMsg>

6. 4. 9 GetLimit

Cash Management Standard

GetLimit_PM

Scope: The GetLimit message is sent to request information about

- a bilateral limit (current or standing order limit) defined vis-à-vis
 - another direct PM participant
 - a virtual group of accounts (definition and change of limits, possible for the whole group only, not possible for the single account holder, the displayed limit is the limit of the wole group, not the limit of a single account which belongs to the virtual account)
- the multilateral limit (current or standing order limit) defined vis-à-vis
 - all direct PM participants and virtual group of accounts without a bilateral limit.

The GetLimit message can be sent by the application of the

- direct PM participant
- group of accounts manager

The GetLimit message is replied by a ReturnLimit message.

<camt.009.001.xx>

Structure:

Message name for GetLimit	<GetLmt>
Message Header	<MsgHdr>
Message Identification	<MsgId></MsgId>
End of Message Header	</MsgHdr>
LimitQueryDefinition	<LmtQryDef>
LimitCriteria	<LmtCrit>
NewCriteria	<NewCrit>
SearchCriteria	<SchCrit>
Account Owner	<AcctOwnr>
Financial Institution Identification	<FinInstnId>
BICFIIdentifier	<BICFI></BICFI>
End of Financial Institution Identification	</FinInstnId>
End of Account owner	</AcctOwnr>
End of SearchCriteria	</SchCrit>
End of NewCriteria	</NewCrit>
End of LimitCriteria	</LmtCrit>
End of LimitQueryDefinition	</LmtQryDef>
End of message name for GetLimit	</GetLmt>

Attributes:

name of attribute	format	short description	description
<GetLmt>		Message name for GetLimit	Message name for GeLimit
		Mandatory	Validation:
		A2A	
<MsgHdr>		Message Header	Set of characteristics specific to the message
		Mandatory	Validation:
		A2A	[1..1]
<MsgId>-</MsgId>	35x	Message Identification	Message Identification
		Mandatory	Validation:
		A2A	[1..1]
</MsgHdr>		End of Message Header	
		Mandatory	Validation:
		A2A	[1..1]
<LmtQryDef>		LimitQueryDefinition	Definition of the limit query.
		Optional	Validation:
		A2A	[0..1]
<LmtCrit>		LimitCriteria	Defines the limit query criteria.
		Optional	Validation:
			[0..1]in PM only NewCrit is used
<NewCrit>		NewCriteria	Defines the criteria based on which the information is extracted.
		Mandatory	Validation:
		A2A	[1..1]Return Criteria is not used in PM
<SchCrit>		SearchCriteria	Defines the criteria used to search for.
		Optional	Validation:
		A2A	*****[0..1]only Account Owner as search criteria is possible, all possible Limits are delivered within the response of the ReturnLimit message differs from the cash management standard only one occurrence is used
<AcctOwnr>		Account Owner	
		Optional	Validation:
		A2A	[0..1]
<FinInstnId>		Financial Institution Identification	Financial Institution Identification
		Mandatory	Validation:
			[1..1]
<BICFI>-</BICFI>	4!a2!a2!c3!c	BICFIIdentifier	BICFIIdentifier
			BIC of the RTGS main Account / SSP-Participant used on behalf of third parties or BIC of the group of accounts manager
		Optional	Validation:
			[0..1]Specifies the participant to which the data is referred. The attribute is mandatory when the requestor is the group of accounts manager or the NCB of the participant, when not stated the BIC of the participant is used

name of attribute	format	short description	description
</FinInstId>		End of Financial Institution Identification Mandatory	End of Financial Institution Identification Validation: [1..1]
</AcctOwnr>		End of Account owner Optional	Validation: [0..1]
</SchCrit>		End of SearchCriteria Optional A2A	End of SearchCriteria Validation: *****[0..1]different from the cash management standard only one occurrence is used
</NewCrit>		End of NewCriteria Mandatory A2A	End of NewCriteria Validation: [1..1]
</LmtCrit>		End of LimitCriteria Optional	End of LimitCriteria Validation: [0..1]
</LmtQryDef>		End of LimitQueryDefinition Optional A2A	End of LimitQueryDefinition Validation: [0..1]
</GetLmt>		End of message name for GetLimit Mandatory A2A	Validation:

Error Codes:

Order	Error code				Error Text / Validation/ Remark
	SSP	Y-copy	V-shape	XML	
1	X41			1401	Error Text: No permission. RBAC User role(s) are not sufficient. Validation: RBAC role name "APPLICATE" or "APPLICBTE" are required Remark: checked by ICM / ReturnLimit
2	X42			1402	Error Text: No authorisation. User is not allowed acting on behalf of another participant. Validation: AcctOwnr ((profile group of account manager) value must indicate the credit institution itself or a participant the credit institution is entitled to act on behalf of Remark: checked by ICM / ReturnLimit
3	X47			1407	Error Text: No authorisation. User is not allowed acting on behalf of another Participant as Central Bank Validation: AcctOwnr (profile central bank) value must indicate the central bank itself or a participant the central bank is responsible for Remark: checked by ICM / ReturnLimit
4	X45			1405	Error Text: No authorisation or rather interaction not possible. User is not allowed acting on behalf of another participant as Group of Account manager Validation: AcctOwnr (profile group of account manager) value must indicate a member of the group of accounts the participant is the manager of Remark: checked by ICM / ReturnLimit
5	X40			1400	Error Text: BIC must indicate a SSP participant Validation: BIC must indicate a SSP participant Remark: checked by ICM / ReturnLimit
6	862	C2	TM01	2862	Error Text: Request out of cut-off time Validation: Possibility to use this function during the current phase of business day. Remark: checked by PM / ReturnLimit

GetLimit_PM_1

Scope: Request Get Limit: Sending party and SSP Participant are identic.

Message name for GetLimit	<GetLmt>
Message Header	<MsgHdr>
Message Identification	<MsgId>ABC123</MsgId>
End of Message Header	</MsgId>
End of message name for GetLimit	</GetLmt>

GetLimit_PM_2

Scope: Get Limit: request on behalf of third party. Sending party (e.g. NCB) and SSP Participant (Account Owner DEUTDEFFXXX) are different.

Message name for GetLimit	<GetLmt>
Message Header	<MsgHdr>
Message Identification	<MsgId>ABC123</MsgId>
End of Message Header	</MsgHdr>
LimitQueryDefinition	<LmtQryDef>
NewCriteria	<LmtCrit>
NewCriteria	<NewCrit>
SearchCriteria	<SchCrit>
Account Owner	<AcctOwnr>
Financial Institution Identification	<FinInstnId>
BICFIIdentifier	<BICFI>DEUTDEFFXXX</BICFI>
End of Financial Institution Identification	</FinInstnId>
End of Account owner	</AcctOwnr>
End of SearchCriteria	</SchCrit>
End of NewCriteria	</NewCrit>
End of NewCriteria	</LmtCrit>
End of LimitQueryDefinition	</LmtQryDef>
End of message name for GetLimit	</GetLmt>

6. 4.10 GetReservation

Cash Management Standard

GetReservation_PM

Scope: The GetReservation message is sent to request information about

- the highly-urgent reserve (current or standing order)
- the urgent reserve (current or standing order)

The GetReservation message can be sent by the application of the

- direct PM participant
- group of accounts manager ("Virtual account" reservation of liquidity possible for the whole group only, the displayed reservation are reservation of the wole group, not the reservation of a single account which belongs to the virtual account)

The GetReservation message is replied by a ReturnReservation message.

<camt.046.001.xx>

Structure:

message name for GetReservation	<GetRsvatn>
Message Header	<MsgHdr>
Message Identification	<MsgId></MsgId>
End of Message Header	</MsgHdr>
ReservationQueryDefinition	<RsvatnQryDef>
ReservationCriteriaDefinition	<RsvatnCrit>
NewCriteria	<NewCrit>
SearchCriteria	<SchCrit>
Account Owner	<AcctOwnr>
Financial Institution Identification	<FinInstnId>
BICFIIdentifier	<BICFI></BICFI>
End of Financial Institution Identification	</FinInstnId>
End of Account owner	</AcctOwnr>
End of SearchCriteria	</SchCrit>
End of NewCriteria	</NewCrit>
End of ReservationCriteriaDefinition	</RsvatnCrit>
End of ReservationQueryDefinition	</RsvatnQryDef>
End of message name for GetReservation	</GetRsvatn>

Attributes:

name of attribute	format	short description	description
<GetRsvatn>		message name for GetReservation Mandatory A2A	message name for GetReservation Validation:
<MsgHdr>		Message Header Mandatory A2A	Set of characteristics specific to the message Validation: [1..1]
<MsgId>-</MsgId>	35x	Message Identification Mandatory A2A	Message Identification Validation: [1..1]
</MsgHdr>		End of Message Header Mandatory A2A	Validation: [1..1]
<RsvatnQryDef>		ReservationQueryDefinition Optional A2A	ReservationQueryDefinition Validation: [0..1]
<RsvatnCrit>		ReservationCriteriaDefinition Optional A2A	ReservationCriteriaDefinition Validation: [0..1]
<NewCrit>		NewCriteria Mandatory A2A	Defines the criteria based on which the information is extracted. Validation: [1..1]
<SchCrit>		SearchCriteria Optional A2A	Defines the criteria used to search for. Validation: [0..1]
<AcctOwnc>		Account Owner Optional	Validation: [0..1]
<FinInstId>		Financial Institution Identification Mandatory	Financial Institution Identification Validation: [1..1]
<BICFI>-</BICFI>	4!a2!a2!c3!c	BICFIIdentifier Optional A2A	BICFIIdentifier BIC of the RTGS main account / SSP-Participant used on behalf of third parties Validation: [0..1] Specifies the participant to which the data is referred. The attribute is mandatory when the requestor is the group of accounts manager or the NCB of the SSP participant, when not stated the BIC of the participant is used
</FinInstId>		End of Financial Institution Identification Mandatory	End of Financial Institution Identification Validation:

name of attribute	format	short description	description
			[1..1]
</AcctOwnr>		End of Account owner Optional	Validation: [0..1]
</SchCrit>		End of SearchCriteria Optional A2A	End of SearchCriteria Validation: [0..1]
</NewCrit>		End of NewCriteria Mandatory A2A	Validation: [1..1]
</RsvatnCrit>		End of ReservationCriteriaDefinition Optional A2A	end of ReservationCriteriaDefinition Validation: [0..1]
</RsvatnQryDef>		End of ReservationQueryDefinition Optional A2A	end of ReservationQueryDefinition Validation: [0..1]
</GetRsvatn>		End of message name for GetReservation Mandatory A2A	end of message name for GetReservation Validation:

Error Codes:

Order	Error code				Error Text / Validation/ Remark
	SSP	Y-copy	V-shape	XML	
1	X41			1401	Error Text: No permission. RBAC User role(s) are not sufficient. Validation: RBAC role name "APPLICATE" or "APPLICBTE" are required Remark: checked by ICM / ReturnReservation
2	X42			1402	Error Text: No authorisation. User is not allowed acting on behalf of another participant. Validation: AcctOwnr (profile credit institution) value must indicate the credit institution itself or a participant the credit institution is entitled to act on behalf of Remark: checked by ICM / ReturnReservation
3	X45			1405	Error Text: No authorisation or rather interaction not possible. User is not allowed acting on behalf of another participant as Group of Account manager Validation: AcctOwnr (profile group of account manager) value must not indicate another participant than the manager himself. Remark: checked by ICM / ReturnReservation
4	X47			1407	Error Text: No authorisation. User is not allowed acting on behalf of another Participant as Central Bank Validation: AcctOwnr (profile central bank) value must indicate the central bank itself or a participant the central bank is responsible for Remark: checked by ICM / ReturnReservation
5	X40			1400	Error Text: BIC must indicate a SSP participant Validation: BIC must indicate a SSP participant Remark: checked by ICM / ReturnReservation
6	862	C2	TM01	2862	Error Text: Request out of cut-off time Validation: Possibility to use this function during the current phase of business day. Remark: checked by PM / ReturnReservation

GetReservation_PM_1

Scope: Request for all different types of reservation. Sending party and BIC SSP-Participant (AccountOwner) are identical

message name for GetReservation	<GetRsvatn>
Message Header	<MsgHdr>
Message Identification	<MsgId>ABC123</MsgId>
End of Message Header	</MsgHdr>
End of message name for GetReservation	</GetRsvatn>

GetReservation_PM_2

Scope: Request on behalf of third party Sending party and Account Owner BIC (DRESDEFFXXX) are different.

message name for GetReservation	<GetRsvatn>
Message Header	<MsgHdr>
Message Identification	<MsgId>ABC123</MsgId>
End of Message Header	</MsgHdr>
ReservationQueryDefinition	<RsvatnQryDef>
ReservationCriteriaDefinition	<RsvatnCrit>
NewCriteria	<NewCrit>
SearchCriteria	<SchCrit>
Account Owner	<AcctOwnr>
Financial Institution Identification	<FinInstnId>
BICFIIdentifier	<BICFI>DRESDEFFXXX</BICFI>
End of Financial Institution Identification	</FinInstnId>
End of Account owner	</AcctOwnr>
End of SearchCriteria	</SchCrit>
End of NewCriteria	</NewCrit>
End of ReservationCriteriaDefinition	</RsvatnCrit>
End of ReservationQueryDefinition	</RsvatnQryDef>
End of message name for GetReservation	</GetRsvatn>

6. 4.11 GetSequence

SSP Proprietary Messages

GetSequence_PM

Scope: The GetSequence message is sent to request information about

the level out sequence to fund debit balances on single accounts.

The group of accounts manager chooses the sequence of the accounts how they are used to fund debit balances on single accounts. There exist no level out sequence for sub accounts - they are balanced together with the corresponding RTGS account. The CB will only get a selection of accounts of their area (exception: the CB of the GoA manager will get all information of the whole group)

The GetSequence message can be sent by the application of the

- group of accounts manager
- the CB acting on behalf of group of accounts manager

The GetSequence message is replied by a ReturnSequence message.

<camt.998.001.xx>

Structure:

Message Type	<PrtryMsg>
Message Header	<MsgHdr>
Message Identification	<MsgId></MsgId>
End of Message Header	</MsgHdr>
Proprietary Data	<PrtryData>
Proprietary Data type	<Tp>GetSequence</Tp>
Proprietary Data	<Data>
SSP Proprietary Data	<SspPrtryDt>
Sequence query definition	<SqncQryDef>
Sequence Criteria	<SqncCrit>
NewCriteria	<NewCrit>
SearchCriteria	<SchCrit>
Account Owner	<AcctOwnr></AcctOwnr>
End of SearchCriteria	</SchCrit>
End of NewCriteria	</NewCrit>
End sequence criteria	</SqncCrit>
End sequence query definition	</SqncQryDef>
End of SSP Proprietary Data	</SspPrtryDt>
End of Proprietary Data	</Data>
End of Proprietary Data	</PrtryData>
End proprietary message	</PrtryMsg>

Attributes:

name of attribute	format	short description	description
<PrtryMsg>		Message Type Mandatory A2A	Validation:
<MsgHdr>		Message Header Mandatory A2A	Set of characteristics specific to the message Message Reference Validation: [1..1]
<MsgId>-</MsgId>	35x	Message Identification Mandatory A2A	Message Identification Validation: [1..1]
</MsgHdr>		End of Message Header Mandatory A2A	Validation: [1..1]
<PrtryData>		Proprietary Data Mandatory A2A	Proprietary Data Validation: [1..1]
<Tp>-</Tp>		Proprietary Data type Mandatory A2A	Proprietary Data type here only GetSequence is possible Validation: [1..1]
<Data>		Proprietary Data Mandatory	Proprietary data content Validation: [1..1]
<SspPrtryDt>		SSP Proprietary Data Mandatory A2A	SSP Proprietary Data Validation: [1..1]
<SqncQryDef>		Sequence query defintion Optional A2A	free format tag Validation: [0..1]
<SqncCrit>		Sequence Criteria Optional A2A	free format tag Validation: [0..1]
<NewCrit>		NewCriteria Optional A2A	Defines the criteria based on which the information is extracted. Validation: [0..1]
<SchCrit>		SearchCriteria Optional A2A	Defines the criteria used to search for. Validation: [0..1]
<AcctOwnr>-</AcctOwnr>	11x	Account Owner	BICIdentifier

name of attribute	format	short description	description
			e.g. needed on behalf of third parties if e. g. the NCB are able to start several transactions on behalf their national banking community. BIC of GoA manager (virtual account) / in case if the CB is acting on behalf, the GoA manager she is responsible for
		Optional	Validation:
		A2A	[0..1]
</SchCrit>		End of SearchCriteria	
		Optional	Validation:
		A2A	[0..1]
</NewCrit>		End of NewCriteria	
		Optional	Validation:
		A2A	[0..1]
</SqncCrit>		End sequence criteria	free format tag
		Optional	Validation:
		A2A	[0..1]
</SqncQryDef>		End sequence query definition	free format tag
		Optional	Validation:
		A2A	[0..1]
</SspPrtryDt>		End of SSP Proprietary Data	End of Root element for all SSP proprietary data
		Mandatory	Validation:
		A2A	[1..1]
</Data>		End of Proprietary Data	
		Mandatory	Validation:
			[1..1]
</PrtryData>		End of Proprietary Data	End of Proprietary Data
		Mandatory	Validation:
		A2A	[1..1]
</PrtryMsg>		End proprietary message	
		Mandatory	Validation:
		A2A	

Error Codes:

Order	Error code				Error Text / Validation/ Remark
	SSP	Y-copy	V-shape	XML	
1	X41			1401	Error Text: No permission. RBAC User role(s) are not sufficient. Validation: RBAC role name APPLICATE or APPLICBTE are required Remark: checked by ICM / ReturnSequence
2	X40			1400	Error Text: BIC must indicate a SSP participant Validation: BIC must indicate a SSP participant Remark: checked by ICM / ReturnSequence
3	X42			1402	Error Text: No authorisation. User is not allowed acting on behalf of another participant. Validation: AcctOwnr (profile CI) value must indicate the CI itself or a participant the CI is entitled to act on behalf of Remark: checked by ICM / ReturnSequence
4	X51			1411	Error Text: The selected participant is no Group of Accounts Manager Validation: AcctOwnr (profile CI) CI must be a GoA manager Remark: checked by ICM / ReturnSequence
5	X47			1407	Error Text: No authorisation. User is not allowed acting on behalf of another Participant as Central Bank Validation: AcctOwnr (profile CB) value must indicate the CB itself or a participant the CB is responsible for Remark: checked by ICM / ReturnSequence
6	X51			1411	Error Text: The selected participant is no Group of Accounts Manager Validation: AcctOwnr (profile CB) value must indicate a GoA manager the CB is responsible for Remark: checked by ICM / ReturnSequence
7	X45			1405	Error Text: No authorisation or rather interaction not possible. User is not allowed acting on behalf of another participant as Group of Account manager Validation: AcctOwnr (profile GoA) value must indicate a member of the group of accounts the participant is the manager of Remark: checked by ICM / ReturnSequence
8	X51			1411	Error Text: The selected participant is no Group of Accounts Manager Validation: AcctOwnr (profile GoA) value must indicate the GoA manager himself Remark: checked by ICM / ReturnSequence
9	862	C2	TM01	2862	Error Text: Request out of cut-off time Validation: Possibility to use this function during the current phase of business day. Remark: checked by PM / ReturnSequence

GetSequence_PM_1

Scope: Requestor is the CB, acting on behalf of the GoA manager BIC DEUTDEFFXXX

Message Type	<PrtryMsg>
Message Header	<MsgHdr>
Message Identification	<MsgId>ABC123</MsgId>
End of Message Header	</MsgHdr>
Proprietary Data	<PrtryData>
Proprietary Data type	<Tp>GetSequence</Tp>
Proprietary Data	<Data>
SSP Proprietary Data	<SspPrtryDt>
Sequence query definition	<SqncQryDef>
Sequence Criteria	<SqncCrit>
NewCriteria	<NewCrit>
SearchCriteria	<SchCrit>
Account Owner	<AcctOwnr>DEUTDEFFXXX</AcctOwnr>
End of SearchCriteria	</SchCrit>
End of NewCriteria	</NewCrit>
End sequence criteria	</SqncCrit>
End sequence query definition	</SqncQryDef>
End of SSP Proprietary Data	</SspPrtryDt>
End of Proprietary Data	</Data>
End of Proprietary Data	</PrtryData>
End proprietary message	</PrtryMsg>

GetSequence_PM_2

Scope: Requestor is a GoA manager

Message Type	<PrtryMsg>
Message Header	<MsgHdr>
Message Identification	<MsgId>ABC123</MsgId>
End of Message Header	</MsgHdr>
Proprietary Data	<PrtryData>
Proprietary Data type	<Tp>GetSequence</Tp>
Proprietary Data	<Data>
SSP Proprietary Data	<SspPrtryDt>
End of SSP Proprietary Data	</SspPrtryDt>
End of Proprietary Data	</Data>
End of Proprietary Data	</PrtryData>
End proprietary message	</PrtryMsg>

6. 4.12 GetSettlementInformation (for CBs only)

SSP Proprietary Messages

GetSettlementInformation_PM

Scope: The GetSettlementInformation message is used to request more detailed information related to any booking reported in ReturnTransaction. For debtor and creditor side following information will be returned:

- BIC
- Account ID (in case of booking on sub accounts)
- Country code of the responsible CB
- Name of the Group of Accounts (if the account owner is member of a Virtual Account)

The GetSettlementInformation message is replied by a ReturnSettlementInformation.

<camt.998.001.xx>

Structure:

Name Proprietary message	<PrtryMsg>
Message Header	<MsgHdr>
Message Identification	<MsgId></MsgId>
End of Message Header	</MsgHdr>
Proprietary Data	<PrtryData>
Proprietary Data type	<Tp>GetSettlementInformation</Tp>
Proprietary Data	<Data>
SSP Proprietary Data	<SspPrtryDt>
Settlement Information Query Definition	<SttlmInfQryDef>
Settlement Information Criteria	<SttlmInfCrit>
NewCriteria	<NewCrit>
SearchCriteria	<SchCrit>
InstructionReference	<InstrRef>
Proprietary Reference	<PrtryRef></PrtryRef>
End of InstructionReference	</InstrRef>
End of SearchCriteria	</SchCrit>
End of NewCriteria	</NewCrit>
End settlement Information Criteria	</SttlmInfCrit>
End settlement Information Query Definition	</SttlmInfQryDef>
End of SSP Proprietary Data	</SspPrtryDt>
End of Proprietary Data	</Data>
End of Proprietary Data	</PrtryData>
End proprietary message	</PrtryMsg>

Attributes:

name of attribute	format	short description	description
<PrtryMsg>		Name Proprietary message Mandatory A2A	Validation:
<MsgHdr>		Message Header Mandatory A2A	Set of characteristics specific to the message Message Reference Validation: [1..1]
<MsgId>-</MsgId>	35x	Message Identification Mandatory A2A	Message Identification Validation: [1..1]
</MsgHdr>		End of Message Header Mandatory A2A	Validation: [1..1]
<PrtryData>		Proprietary Data Mandatory A2A	Proprietary Data Validation: [1..1]
<Tp>-</Tp>		Proprietary Data type Mandatory A2A	Proprietary Data type here only GetSettlementInformation is possible Validation: [1..1]
<Data>		Proprietary Data Mandatory	Proprietary data content Validation: [1..1]
<SspPrtryDt>		SSP Proprietary Data Mandatory A2A	Root element for all SSP proprietary data Validation: [1..1]
<SttlmInfQryDef>		Settlement Information Query Definition Mandatory A2A	Settlement Information Query Definition Validation: [1..1]
<SttlmInfCrit>		Settlement Information Criteria Mandatory A2A	Settlement Information Criteria Validation: [1..1]
<NewCrit>		NewCriteria Mandatory A2A	Validation: [1..1]
<SchCrit>		SearchCriteria Mandatory A2A	Validation: [1..1]
<InstrRef>		InstructionReference Mandatory	InstructionReference Validation:

name of attribute	format	short description	description
		A2A	[1..1] in PM only <InstrRef> needed
<PrtryRef>-</PrtryRef>	16n	Proprietary Reference	Proprietary Reference SSP Booking ID (generated by PM [16x]; unique and unambiguous identifier of a booking - is delivered within every ReturnTransaction message)
		Mandatory	Validation: [1..1]
		A2A	
</InstrRef>		End of InstructionReference	
		Mandatory	Validation: [1..1]
		A2A	
</SchCrit>		End of SearchCriteria	End of SearchCriteria
		Mandatory	Validation: [1..1]
		A2A	
</NewCrit>		End of NewCriteria	
		Mandatory	Validation: [1..1]
		A2A	
</SttlmInfCrit>		End settlement Information Criteria	end settlement Information Criteria
		Mandatory	Validation: [1..1]
		A2A	
</SttlmInfQryDef>		End settlement Information Query Definition	end settlement Information Query Definition
		Mandatory	Validation: [1..1]
		A2A	
</SspPrtryDt>		End of SSP Proprietary Data	End of Root element for all SSP proprietary data
		Mandatory	Validation: [1..1]
		A2A	
</Data>		End of Proprietary Data	
		Mandatory	Validation: [1..1]
</PrtryData>		End of Proprietary Data	End of Proprietary Data
		Mandatory	Validation: [1..1]
		A2A	
</PrtryMsg>		End proprietary message	
		Mandatory	Validation: [1..1]
		A2A	

Error Codes:

Order	Error code				Error Text / Validation/ Remark
	SSP	Y-copy	V-shape	XML	
1	X41			1401	Error Text: No permission. RBAC User role(s) are not sufficient. Validation: message is allowed for CB's only. RBAC role name "APPLICBTE" is required Remark: checked by ICM / ReturnSettlementInformation
2	P13			P013	Error Text: No payment found Validation: PrtryRef does exist/ available settlement information Remark: ReturnSettlementInformation
3	862	C2	TM01	2862	Error Text: Request out of cut-off time Validation: Possibility to use this function during the current phase of business day. Remark: checked by PM / ReturnSettlementInformation

GetSettlementInformation_PM_1

Scope: GetSettlementInformation with SSP Booking ID

Name Proprietary message	<PrtryMsg>
Message Header	<MsgHdr>
Message Identification	<MsgId>ABC123</MsgId>
End of Message Header	</MsgHdr>
Proprietary Data	<PrtryData>
Proprietary Data type	<Tp>GetSettlementInformation</Tp>
Proprietary Data	<Data>
SSP Proprietary Data	<SspPrtryDt>
Settlement Information Query Definition	<SttlmInfQryDef>
Settlement Information Criteria	<SttlmInfCrit>
NewCriteria	<NewCrit>
SearchCriteria	<SchCrit>
InstructionReference	<InstrRef>
Proprietary Reference	<PrtryRef>123</PrtryRef>
End of InstructionReference	</InstrRef>
End of SearchCriteria	</SchCrit>
End of NewCriteria	</NewCrit>
End settlement Information Criteria	</SttlmInfCrit>
End settlement Information Query Definition	</SttlmInfQryDef>
End of SSP Proprietary Data	</SspPrtryDt>
End of Proprietary Data	</Data>
End of Proprietary Data	</PrtryData>
End proprietary message	</PrtryMsg>

6. 4.13 GetTransaction

Cash Management Standard

GetTransaction_PM

Scope: The GetTransaction message is sent to receive information about payments debited and/or credited to a direct PM participant's account. A subset of these payments can be requested by defining the following criteria: SWIFT message type, amount, settlement (debits/credits), priority (highly urgent, urgent, normal), type of payment, execution date, error code, status of payment, counterpart country, counterpart BIC, timed payments, settlement time, SWIFT fields, TRN.

The GetTransaction can be sent by

- Central Banks:

A CB is able to query payments related to her own accounts, accounts of participants she is responsible for, of members of a group of accounts where the CB is responsible for the group's manager or payments stemming from AS messages of an AS the CB is responsible for. In case of AS payments or payments related to a Group of Accounts which are only settled in accounts the CB is not responsible for, she has to use the account id of the debited or credited participant in the request. If the CB does not select an account all bookings for which the debit account or the credit account is linked to a participant the CB is responsible for will be returned. (SSP Business Relation = National; The multinational context is not applicable to the A2A mode.)

- Group of Accounts managers:

A GoA manager may query payments related to his own and his group members' accounts. He has no access rights to get payment details (SWIFT fields, InstructionCopy) of transactions only related to group members' accounts. - These information can neither be used as search criteria nor be requested as return criteria. (Return criteria indicators may be set to 'false!')

- Direct PM participants:

A direct participant only gets information on payments concerning his accounts.

- Ancillary Systems:

An AS has access to payment information in case the transaction is settled on ist own account, on a Settlement Bank's sub account linked to the AS, or on a Settlement Bank's main account if the payment is stemming from a file the AS has sent.

The GetTransaction message is replied by a ReturnTransaction message.

Business Data Compression via delta sets is supported. A GetTransaction request can be performed with the query type "CHNG", "MODF" or "DELD".

Technical Example:

A user wants to have continues information on the payments in status "final". He keeps a table where the actual payments in this status are recorded. When the business day starts, he sends a query with the suitable new selection criteria. SSP executes the query and returns the complete result set. With the result is returned a reference to this query. Once the query was executed, the user continues to refer to this query. No new selection criteria are stated. Each query is for new payments in status "final".

The returned data enables the user to update his current table.

<camt.005.001.xx>

Structure:

Message name for GetTransaction	<GetTx>
Message Header	<MsgHdr>
Message Identification	<MsgId></MsgId>
End of Message Header	</MsgHdr>
Transaction query definition	<TxQryDef>
QueryTypeCode	<QryTp></QryTp>
Transaction query criteria.	<TxCrit>
choice amongst	xorQryNmNewCrit
QueryName	<QryNm></QryNm>
NewCriteria	<NewCrit>
SearchCriteria	<SchCrit>
PaymentTo	<PmtTo>
Member Identification	<Mmbld>
Financial Institution Identification	<FinInstnId>
BICFIIdentifier	<BICFI></BICFI>
End of Financial Institution Identification	</FinInstnId>
End of Member Identification	</Mmbld>
Country Code	<Ctry></Ctry>
End PaymentTo	</PmtTo>
Payment From	<PmtFr>

Member Identification	<Mmbld>
Financial Institution Identification	<FinInstnId>
BICFIIdentifier	<BICFI></BICFI>
End of Financial Institution Identification	</FinInstnId>
End of Member Identification	</Mmbld>
Country Code	<Ctry></Ctry>
End Payment From	</PmtFr>
PaymentSearch	<PmtSch>
MessageIdentification	<Msgld></Msgld>
RequestedExecutionDate	<ReqdExctnDt>
DateSearchChoice	<DtSch>
DateSearchChoice	xorDtSch
FromDate	<FrDt></FrDt>
ToDate	<ToDt></ToDt>
FromToDate	<FrToDt>
FromDate	<FrDt></FrDt>
ToDate	<ToDt></ToDt>
End FromToDate	</FrToDt>
EqualDate	<EQDt></EQDt>
End Date Search	/xorDtSch
End of Date Search	</DtSch>
End of RequestedExecutionDate	</ReqdExctnDt>
PaymentIdentification	<PmtId>
choice	xorLngBizIdPrtryRef
LongBusinessIdentification	<LngBizId>
TransactionIdentification 16x	<TxId></TxId>
InterbankSettlementAmount	<IntrBkSttlmAmt></IntrBkSttlmAmt>
Value date	<IntrBkSttlmDt></IntrBkSttlmDt>
PaymentMethod	<PmtMtd>
Choice	xorFINMTPrtry
FINMessageType	<FINMT></FINMT>
Proprietary type	<Prtry></Prtry>
End of Choice	/xorFINMTPrtry
End of Payment Method	</PmtMtd>
Instructing Agent	<InstgAgt>
Financial Institution Identification	<FinInstnId>
BICFIIdentifier	<BICFI></BICFI>
End of Financial Institution Identification	</FinInstnId>
End of Instructing Agent	</InstgAgt>
Instructed Agent	<InstdAgt>
Financial Institution Identification	<FinInstnId>
BICFIIdentifier	<BICFI></BICFI>
End of Financial Institution Identification	</FinInstnId>
End of Instructed Agent	</InstdAgt>
EndToEndIdentification	<EndToEndId></EndToEndId>
End LongBusinessIdentification	</LngBizId>
ProprietaryId	<PrtryId></PrtryId>
End of choice	/xorLngBizIdPrtryRef
EndPaymentIdentification	</PmtId>
PaymentStatus	<Sts>
PaymentStatusCode	<PmtInstrSts>
choice	xorPdgStsFnlStsFnlandPdgSts

ProprietaryPaymentTypeCode					<Prtry></Prtry>
End Payment Type					</PmtTp>
Priority					<Prty>
Priority Code					<Cd></Cd>
End Priority					</Prty>
ProcessingValidityTime					<PrcgVldtyTm>
choice					xorFrDtTmToDtTmDtTmRg
FromDateTime					<FrDtTm></FrDtTm>
ToDateTime					<ToDtTm></ToDtTm>
DateTimeRange					<DtTmRg>
FromDateTime					<FrDtTm></FrDtTm>
ToDateTime					<ToDtTm></ToDtTm>
End Date Time Range					</DtTmRg>
End of choice					/xorFrDtTmToDtTmDtTmRg
End of ProcessingValidityTime					</PrcgVldtyTm>
Instruction					<Instr></Instr>
TransactionIdentification 16x					<Txld></Txld>
EndToEndIdentification					<EndToEndId></EndToEndId>
Parties					<Pties>
Debtor Agent					<DbtrAgt>
End of Financial Institution Identification					</FinInstnId>
BICFIIdentifier					<BICFI></BICFI>
End of Financial Institution Identification					</FinInstnId>
End of Debtor Agent					</DbtrAgt>
InstructedReimbursementAgent					<InstdRmbrsmntAgt>
Financial Institution Identification					<FinInstnId>
BICFIIdentifier					<BICFI></BICFI>
End of Financial Institution Identification					</FinInstnId>
End of InstructedReimbursementAgent					</InstdRmbrsmntAgt>
IntermediaryAgent					<IntrmyAgt>
Financial Institution Identification					<FinInstnId>
BICFIIdentifier					<BICFI></BICFI>
End of Financial Institution Identification					</FinInstnId>
End of IntermediaryAgent					</IntrmyAgt>
Creditor Agent					<CrdrAgt>
Financial Institution Identification					<FinInstnId>
BICFIIdentifier					<BICFI></BICFI>
End of Financial Institution Identification					</FinInstnId>
End of Creditor Agent					</CrdrAgt>
Creditor					<Cdtr>
Financial Institution Identification					<FinInstnId>
BICFIIdentifier					<BICFI></BICFI>
End of Financial Institution Identification					</FinInstnId>
End of Creditor					</Cdtr>
End of Parties					</Pties>
End of PaymentSearch					</PmtSch>
AccountEntrySearch					<AcctNtrySch>
Account Identification					<AcctId>
AccountIdentificationChoice					<EQ>
GenericAccountIdentification					<Othr>
Identification					<Id></Id>
GenericAccountIdentification					<Othr>

End of Transaction query criteria.			</TxCrit>
End of Transaction query definition			</TxQryDef>
End of Messagename for GetTransaction			</GetTx>

Attributes:

name of attribute	format	short description	description
<GetTx>		Message name for GetTransaction Mandatory A2A	Message name for GetTransaction Validation:
<MsgHdr>		Message Header Mandatory A2A	Set of characteristics specific to the message Validation: [1..1]
<MsgId>-</MsgId>	35x	Message Identification Mandatory A2A	Message Identification Validation: [1..1]
</MsgHdr>		End of Message Header Mandatory A2A	Validation: [1..1]
<TxQryDef>		Transaction query definition Optional A2A	Definition of the transaction query Validation: [0..1]
<QryTp>-</QryTp>		QueryTypeCode Optional A2A	Specifies the nature of the query, i.e. whether the query requests that all matching items be returned or only new matching items since the last similar query be returned. ALLL = All Specifies that the query requests that all matching items be returned. CHNG = Changes Specifies that the query requests that only new matching items since the last similar query be returned. MODF = Modified Specifies that the query requests to return only items that have changed since the last query. DELD = Deleted Specifies that the query requests to return only items that were deleted since the last query. New matching items are those with a new reference (primary key) in the last result set. (Further details can be found in the general chapter for delta set retrieval) Validation: [0..1] CHNG = only new matching items are returned MODF = only modified items are returned DELD = only deleted items are returned The provisioning of delta sets requires an initialisation with a statement of search criteria. These search criteria can be repeated again and again with the three shapings. Then SSP calculates the delta set again and again as difference between the current query and the respective previous query. The business data compression is only implemented for the ReturnTransaction message.
<TxCrit>		Transaction query criteria. Optional A2A	Defines the transaction query criteria. Validation: [0..1]
xorQryNmNewCrit		choice amongst	TransactionCriteriaDefinitionChoice QueryName and NewCriteria

name of attribute	format	short description	description
			<p>Defines the information that is searched either implicitly by recalling a previous query or explicitly by defining the criteria.</p> <p>QueryName [1..1] Max35Text TransactionCriteriaDefinitionChoice NewCriteria [1..1] TransactionCriteria</p> <p>Mandatory: A2A</p>
<QryNm>	35x	QueryName	<p>Recalls the criteria (search and return criteria) defined in a preceding query.</p> <p>Identifier of a preceding message. The cross-reference is used for the creation of delta sets</p> <p>Reference for the delta set retrieval. Value has been returned with the previous ReturnTransaction message</p> <p>Mandatory: A2A</p> <p>Validation: [1..1]</p>
<NewCrit>		NewCriteria	<p>Defines the criteria based on which the information is extracted.</p> <p>Mandatory: A2A</p> <p>Validation: [1..1]</p>
<SchCrit>		SearchCriteria	<p>Defines the criteria used to search for.</p> <p>Optional: A2A</p> <p>Validation: *****[0..1] differs from the cash management standard <PmtTo>, <PmtFrom>, <PmtSch>, <AcctNtrySch> - when not stated all bookings debited or credited to the participant's account(s) will be selected. In case the request is sent by a GoA manager or a Central Bank: All bookings for which the debit account or the credit account is under the responsibility of the requestor will be selected.</p>
<PmtTo>		PaymentTo	<p>Defines the criteria which are used to search for the destination of the payment.</p> <p>SystemIdentification [0..n] MemberIdentification [0..n]</p> <p>Optional: A2A</p> <p>Validation: [0..n] SysId in PM not used</p>
<Mmbld>		Member Identification	<p>Unique and unambiguous identification of a member within a system, assigned using the member identification scheme of the system</p> <p>Optional: A2A</p> <p>Validation: *****[0..1] differs from the cash management standard - In PM only BIC is used. - Only one occurrence of PmtTo/Mmbld is allowed per request.</p>
<FinInstnId>		Financial Institution Identification	<p>Financial Institution Identification</p> <p>Mandatory: A2A</p> <p>Validation: [1..1]</p>
<BICFI>-</BICFI>	4!a2!a2!c3!c	BICFIIdentifier	<p>BICFIIdentifier</p> <p>- BIC of the Receiver - In case the payment is addressed to TRGTXEPLVP, then the BIC of first filled field 56A-58A of MT103/MT202 or field 53A of MT204 (= receiving Internet-based</p>

name of attribute	format	short description	description
		Mandatory A2A	participant) - In case the booking stems from an AS XML message: BIC of the AS Validation: [1..1]
</FinInstnId>		End of Financial Institution Identification Mandatory A2A	End of Financial Institution Identification Validation: [1..1]
</Mmbld>		End of Member Identification Optional A2A	 Validation: [0..1]
<Ctry>-</Ctry>	21a	Country Code	Country Code Code to identify a country, a dependency, or another area of particular geopolitical interest, on the basis of country names obtained from the United Nations (ISO 3166, Alpha-2 code). Counterpart Country - SSP uses the country code(s) on the creditor side also as search criterion for the debtor side. All accounts (including Sub accounts), for which the Central Bank is responsible for, are included in the search. Cross Border Account Groups and Cross Border AS business are not taken into account. This means: - An account, linked to the selected Country Code but member of an Account Group linked to another country, will be taken into account. - An account, not linked to the selected Country Code but member of an Account Group linked to the selected country, will not be taken into account.
		Optional A2A	Validation: [0..1] If one or a list of counterpart countries is present in <PmtFr> element(s) then this element should not be used - or the list of counterpart countries present in <PmtTo> elements has to be equal to the list of counterpart countries present in <PmtFr> elements.
</PmtTo>		End PaymentTo Optional A2A	End PaymentTo Validation: [0..n]
<PmtFr>		Payment From Optional A2A	Defines the criteria which are used to search for the origin of the payment. SystemIdentification [0..n] MemberIdentification [0..n] Validation: [0..n] SysId in PM not used
<Mmbld>		Member Identification Optional A2A	Unique and unambiguous identification of a member within a system, assigned using the member identification scheme of the system Validation: *****[0..1] differs from the cash management standard - In PM only BIC is used. - Only one occurrence of PmtFr/Mmbld is allowed per request.
<FinInstnId>		Financial Institution Identification	Financial Institution Identification

name of attribute	format	short description	description
		Mandatory	Validation:
		A2A	[1..1]
<BICFI>--</BICFI>	4!a2!a2!c3!c	BICFIIdentifier	BICFIIdentifier - BIC of the Sender - In case of payments from Internet-based participants sent by PM with technical BIC TRGTXPMLVP, then the BIC of the IBP from filed 52A. - In case the booking stems from an AS XML message: BIC of the Sender (AS, CB or SB)
		Mandatory	Validation:
		A2A	[1..1]
</FinInstnId>		End of Financial Institution Identification	End of Financial Institution Identification
		Mandatory	Validation:
		A2A	[1..1]
</Mmbld>		End of Member Identification	
		Optional	Validation:
		A2A	[0..1]
<Ctry>--</Ctry>	2!a	Country Code	Country Code Code to identify a country, a dependency, or another area of particular geopolitical interest, on the basis of country names obtained from the United Nations (ISO 3166, Alpha-2 code). Counterpart Country - SSP uses the country code(s) on the debtor side also as search criterion for the creditor side. All accounts (including Sub accounts), for which the Central Bank is responsible for, are included in the search. Cross Border Account Groups and Cross Border AS business are not taken into account. This means: - An account, linked to the selected Country Code but member of an Account Group linked to another country, will be taken into account. - An account, not linked to the selected Country Code but member of an Account Group linked to the selected country, will not be taken into account.
		Optional	Validation:
		A2A	[0..1] If one or a list of counterpart countries is present in <PmtTo> element(s) then this element should not be used - or the list of counterpart countries present in <PmtFr> elements has to be equal to the list of counterpart countries present in <PmtTo> elements.
</PmtFr>		End Payment From	End Payment From
		Optional	Validation:
		A2A	[0..n]
<PmtSch>		PaymentSearch	Defines the criteria which are used to search for a payment. TransactionReference [0..n] TransferValueDate [0..n] InstructionReference [0..n] InstructionStatus [0..n] InstructedAmount [0..n] InstructedAmountCurrency [0..n] CreditDebitIndicator [0..1] InterbankSettlementAmount [0..n] InterbankSettlementAmountCurrency [0..n] PaymentMethod [0..n] ProcessingValidityTime [0..n] Priority [0..n] Instruction [0..n]

name of attribute	format	short description	description
			PaymentType [0..n] *****If the requestor wants to select a single transaction, identified via a Long business identifier (PaymentInstructionReference, Amount, Value date, PaymentMethod, Sender, Receiver, RelatedReference) or an internal booking identifier (SSP-Booking ID) no further selection criteria are allowed (<TxRef>, <TrfValDt>, <InstrSts>, <InstdAmt> etc.). The sequence can be used only once (repetition is not allowed). The requestor has to choose between <InstrRef> or the sequence of select criteria Validation: [0..1]In PM following elements are not used: InstructedAmountCurrency [0..n] InterbankSettlementAmount [0..n] InterbankSettlementAmountCurrency [0..n]
<MsgId>-</MsgId>	16n	MessageIdentification	SSP Business Case ID Validation: *****[0..1] (16n) differs from the cash management standard In SSP the MessageIdentification is used to search for SSP Business Case ID. This enables the user to select all booking entries stemming from this business case.
<ReqdExctnDt>		RequestedExecutionDate	Execution Date / Value Date If the requestor searches for both values ExecutionDate (<TrfValDt>) and Earliest/LatestdebitTime (<PrcgVldtyTm>) the date within the two elements has to be the same, if not the consequence is, that no payment is found. Validation: *****[0..1] differs from the cash management standard in PM only <DtSch> Execution Date
<DtSch>		DateSearchChoice	A choice between search criteria based on dates and date ranges. Execution Date current and future (5 future dates are possible) Validation: [1..1] in PM <NEQDt> is not used Execution Date current and future (5 future dates are possible)
xorDtSch		DateSearchChoice	DateSearchChoice FromDate [1..1] ToDate [1..1] FromToDate [1..1] EqualDate [1..1] Validation:
<FrDt>	ISODate	FromDate	Start date of the range. Validation: [1..1]
<ToDt>	ISODate	ToDate	End date of the range. Date within a particular calendar year represented by YYYY-MM-DD (ISO 8601). Validation:

name of attribute	format	short description	description
		A2A	[1..1]
<FrToDt>		FromDate	A particular time span specified between a start date and an end date.
		Mandatory	Validation:
		A2A	[1..1]
<FrDt>	ISODate	FromDate	Start date of the range.
		Mandatory	Validation:
		A2A	[1..1]
<ToDt>	ISODate	ToDate	End date of the range.
			Date within a particular calendar year represented by YYYY-MM-DD (ISO 8601).
		Mandatory	Validation:
		A2A	[1..1]
</FrToDt>		End FromToDate	End of a particular time span specified between a start date and an end date.
		Mandatory	Validation:
		A2A	[1..1]
<EQDt>	ISODate	EqualDate	A specified date to match.
			Date within a particular calendar year represented by YYYY-MM-DD (ISO 8601).
		Mandatory	Validation:
		A2A	[1..1]
/xorDtSch		End Date Search	End Date Search
		Mandatory	Validation:
		A2A	
</DtSch>		End of Date Search	End of Date Search
		Mandatory	Validation:
		A2A	[1..1]
</ReqdExctnDt>		End of RequestedExecutionDate	
		Optional	Validation:
		A2A	[0..1]
<PmtId>		PaymentIdentification	Set of elements to provide further means of referencing a payment transaction
			identification of a payment
		Optional	Validation:
		A2A	****[0..1] differs from the cash management standard In PM only <PrtryRef> or <LongBizId> can be used.
xorLngBizIdPrtryRef		choice	choice between <LongBizId> and <PrtryRef>
		Mandatory	Validation:
		A2A	
<LngBizId>		LongBusinessIdentification	Identifies a payment instruction by a set of characteristics which provides an unambiguous identification of the instruction.

name of attribute	format	short description	description
			<p>TransactionIdentification InterBankSettlementAmount InterBankSettlementDate PaymentMethod InstructingAgent InstructedAgent EndToEndIdentification</p> <p>If the LongBusinessIdentification is used, it is passed back inside payment details of the ReturnTransaction message. The LngBizId may not be unambiguous and refer to several booking entries identified by a unique and unambiguous SSP-Booking ID <PrtryRef>.</p> <p>Mandatory:</p> <p>A2A</p> <p>Validation:</p> <p>[1..1]In PM following criteria are mandatory PaymentInstructionReference [1..1] InterbankSettlementAmount [1..1] InterbankValueDate [1..1] PaymentMethod [1..1] InstructingAgentIdentification [1..1] InstructedAgentIdentification [1..1] RelatedReference [0..1]</p>
<TxId>-</TxId>	16x	TransactionIdentification 16x	<p>Unique and unambiguous identification of a payment transaction, as assigned by the originator. The payment transaction reference is used for reconciliation or to link tasks relating to the payment transaction.</p> <p>Instruction Identification - TRN in case of a FIN payment - InstructionIdentification in case of AS XML payments</p> <p>Mandatory:</p> <p>A2A</p> <p>Validation:</p> <p>[1..1]</p>
<IntrBkSttlmAmt>		InterbankSettlementAmount	<p>Amount of money transferred between the instructing agent and instructed agent.</p> <p>Amount</p> <p>Mandatory:</p> <p>A2A</p> <p>Validation:</p> <p>[1..1] in PM only 2 fraction digits are possible</p>
<IntrBkSttlmDt>-</IntrBkSttlmDt>	ISODate	Value date	<p>Value date</p> <p>Value Date</p> <p>Mandatory:</p> <p>A2A</p> <p>Validation:</p> <p>[1..1] Value Date</p>
<PmtMtd>		PaymentMethod	<p>Indicates the message or event from which an instruction has been initiated.</p> <p>FINMessageType [1..1] XMLMessageName [1..1] Proprietary [1..1] Instrument [1..1]</p> <p>Search criteria for payment type for details on payment origin.</p> <p>Mandatory:</p> <p>A2A</p> <p>Validation:</p> <p>*****[1..1] mandatory - differs from the cash management standard In PM only <FINMT> or <Prtry> can be used.</p>
xorFINMTPrtry		Choice	<p>Choice amongst <FINMT> and <Prtry></p> <p>Mandatory:</p> <p>Validation:</p>
<FINMT>-</FINMT>	3x	FINMessageType	<p>possible values: 103 202 204</p> <p>Mandatory:</p> <p>Validation:</p>

name of attribute	format	short description	description
		A2A	[1..1] Possible values are: 202: the result set will include all bookings stemming from an incoming SWIFT FIN message MT202. (MT202, which are created by PM, are not included in this selection criteria.) 103: the result set will include all bookings stemming from an incoming SWIFT FIN message MT103. 204: the result set will include all bookings stemming from an incoming SWIFT FIN message MT204.
<Prtry>-</Prtry>	35x	Proprietary type Mandatory A2A	Proprietary type of payment origin Validation: [1..1]only the values ASXML, T2SXML, TIPSXML, INTERN and ORDER are allowed: ASXML: The result set will include all bookings stemming from an incoming AS XML payments (incl. SBTransferInitiation). T2SXML: The result set will include all bookings stemming from an incoming T2S XML payments INTERN: The result set will include all bookings stemming from internal messages: - Automatic processing by PM, including Standing Orders - Payments delivered from HAM (e.g. Simplified MT202), RM, SF, CRISP, CM ORDER: The result set will include all bookings stemming from current orders sent via ICM. (E.g. Backup Payments. - But not SBTransferInitiation.)
/xorFINMTPtry		End of Choice Mandatory	Validation:
</PmtMtd>		End of Payment Method Mandatory A2A	End of Payment Method Validation: [1..1]
<InstgAgt>		Instructing Agent Mandatory A2A	Instructing Agent Validation: [1..1]
<FinInstnId>		Financial Institution Identification Mandatory A2A	Financial Institution Identification Validation: [1..1]
<BICFI>-</BICFI>	4!a2!a2!c3!c	BICFIIdentifier Mandatory A2A	BICFIIdentifier - Sender - FirstAgent BIC in case of AS XML payments Validation: [1..1]
</FinInstnId>		End of Financial Institution Identification Mandatory A2A	End of Financial Institution Identification Validation: [1..1]
</InstgAgt>		End of Instructing Agent Mandatory A2A	End of Instructing Agent Validation: [1..1]
<InstdAgt>		Instructed Agent Mandatory	Instructed Agent Validation:

name of attribute	format	short description	description
		A2A	[1..1]
<FinInstnId>		Financial Institution Identification Mandatory A2A	Financial Institution Identification Validation: [1..1]
<BICFI>-</BICFI>	4!a2!a2!c3!c	BICFIIdentifier Mandatory A2A	BICFIIdentifier - Receiver - FinalAgent BIC in case of AS XML payments Validation: [1..1]
</FinInstnId>		End of Financial Institution Identification Mandatory A2A	End of Financial Institution Identification Validation: [1..1]
</InstdAgt>		End of Instructed Agent Mandatory A2A	End of Instructed Agent Validation: [1..1]
<EndToEndId>-</EndToEndId>	16x	EndToEndIdentification Optional A2A	Unique and unambiguous identification of a payment transaction, as assigned by any of the parties on the initiating side, that will be passed on throughout the entire end-to-end chain End to End Identification - Related TRN (Field 21 in case of FIN messages) - EndToEndIdentification in case of XML ASI messages Validation: [0..1]
</LngBizId>		End LongBusinessIdentification Mandatory A2A	End LongBusinessIdentification Validation: [1..1]
<PrtryId>-</PrtryId>	16n	ProprietaryId Mandatory A2A	ProprietaryId SSP Booking ID (generated by PM [16x]; unique identifier of a booking) Validation: [0..1]
/xorLngBizIdPrtryRef		End of choice Mandatory	end of choice Validation:
</PmtId>		EndPaymentIdentification Optional A2A	End of Set of elements to reference a payment transaction Validation: [0..1]
<Sts>		PaymentStatus Optional A2A	Validation: [0..n]
<PmtInstrSts>		PaymentStatusCode Optional	Choice between a list of pending statuses or final statuses. Payment Status Validation:

name of attribute	format	short description	description
		A2A	<p>[0..1]In PM only used for Get Transaction: PSTL = Pending STLD = Final (closed normal) STLE = Earmarked noted CAND = Revoked RJTD = Rejected</p> <p>It's not possible to take into account search criteria PaymentInstructionStatusDateTime <PmtInstrStsDtTm> more than once per request. Thus if element InstructionStatus is repeated PaymentInstructionStatusDateTime can only apply to a single status.</p>
xorPdgStsFnIStsFnlandPdgSts	choice	Mandatory	<p>choice amongst <PdgSts>, <FnISts>, and <PdgAndFnISts></p> <p>Validation: choice amongst PendingStatus [1..1] FinalStatus [1..1] FinalStatusCode</p>
<PdgSts>	PendingStatus		<p>Qualifies further the pending status.</p> <p>ACPD= Accepted Transaction has been accepted by the clearing agent.</p> <p>AUTD= Authorised Transaction has been authorised by the transaction administrator or authorised party.</p> <p>INVD= Invalid Transaction is invalid.</p> <p>MATD = Matched Transaction has been matched with a corresponding transaction by the clearing agent.</p> <p>PCAN = PendingCancellation Clearing agent has received a cancellation request for the transaction, and needs either a matching request for cancellation from the counterparty or a confirmation from an authorised party.</p> <p>PFST = PendingFailingSettlement Transaction eligible for immediate settlement, has failed to settle.</p> <p>PSTL= PendingSettlement Transaction is eligible for settlement, but is pending.</p> <p>RMLR = ReceiverMultilateralLimitRelated Transaction causes the 'Receiver multilateral limit' to be exceeded and cannot currently be processed.</p> <p>SMLR = SenderMultilateralLimitRelated Transaction causes the 'Sender multilateral limit' to be exceeded and cannot currently be processed.</p> <p>SRBL = SenderReceiverBilateralLimitRelated Transaction causes the bilateral limit fixed between Sender and Receiver to be exceeded and cannot currently be processed.</p> <p>SSPD = Suspended Transaction has been suspended by the clearing agent.</p> <p>STLE = SettlementEligible Transaction is eligible for future settlement.</p> <p>STLM = SettlementMature Transaction is eligible for immediate settlement.</p> <p>UMAC = Unmatched Clearing agent attempted to match the transaction with a corresponding transaction but failed.</p> <p>VALD = Validated</p>

name of attribute	format	short description	description
			Transaction has been validated by the clearing agent.
		Mandatory	Validation:
	A2A		[1..1] in PM only STLE= earmarked, PSTL = Pending, ACPD = warehoused and STLM = information period (AS payment during information period) are used. <PdgSts> is not allowed if <PmtInstrStsDtTm> is used.
<FnlSts>		FinalStatus	Qualifies further the final status. CAND = Cancelled Transaction has been cancelled. FNLD= Finalised Transaction has been successfully processed by the clearing agent. Settlement will take place outside of the system. RJTD= Rejected Transaction has been rejected by the clearing agent. STLD = Settled Transaction has been successfully processed by the clearing agent.
		Mandatory	Validation:
	A2A		[1..1] in PM only CAND = revoked, STLD = by means of final and RJTD = rejected are used. If <PmtInstrStsDtTm> is used <FnlSts> is only allowed when code word STLD is filled in.
<PdgAndFnlSts>- </PdgAndFnlSts>		PendingAndFinalStatus	State of a payment instruction at a specified time. FINL = Final The payment has been settled or stopped. PDNG = Pending The payment is awaiting settlement.
		Mandatory	Validation:
	A2A		[1..1] <PdgAndFnlSts> is not allowed if <PmtInstrStsDtTm> is used.
/xorPdgStsFnlStsFnlAndPdgSts		End of choice	end of choice amongst <PdgSts>, <FnlSts>, <PdgAndFnlSts>
		Mandatory	Validation: end choice amongst PendingStatus [1..1] FinalStatus [1..1] FinalStatusCode PendingAndFinalStatus [1..1]
</PmtInstrSts>		End PaymentStatusCode	End PaymentStatusCode
		Optional	Validation:
	A2A		[0..1]
<PmtInstrStsDtTm>		PaymentInstructionStatusDateTime	Date and time at which the status was assigned to the transfer. FromDateTime [1..1] ToDateTime [1..1] DateTimeRange [1..1] Settlement Time
		Optional	Validation:
	A2A		[0..1] It's not possible to take into account search criteria PaymentInstructionStatusDateTime <PmtInstrStsDtTm> more than once per request. Thus if element InstructionStatus is repeated PaymentInstructionStatusDateTime can only apply to a

name of attribute	format	short description	description
			single status. Like in U2A mode, only the stated times - and not the dates - are taken into account.
xorFrDtTmToDtTm		choice	DateTimePeriodChoice FromDateTIme [1..1] ToDateTIme [1..1] Mandatory Validation:
<FrDtTm>-</FrDtTm>	ISODateTIme	FromDateTIme	Date and time at which the range starts. Mandatory A2A Validation: [1..1]
<ToDtTm>-</ToDtTm>	ISODateTIme	ToDateTIme	Date and time at which the range ends. Mandatory A2A Validation: [1..1]
<DtTmRg>		DateTimeRange	Range of time between a start date and time and an end date and time. Mandatory A2A Validation: [1..1]
<FrDtTm>-</FrDtTm>	ISODateTIme	FromDateTIme	Date and time at which the range starts. Mandatory A2A Validation: [1..1]
<ToDtTm>-</ToDtTm>	ISODateTIme	ToDateTIme	Date and time at which the range ends. Mandatory A2A Validation: [1..1]
</DtTmRg>		End of DateTimeRange	Mandatory A2A Validation: [1..1]
/xorFrDtTmToDtTm		End of choice	end of choice Mandatory Validation:
</PmtInstrStsDtTm>		End PaymentInstructionStatusDateTIme	End PaymentInstructionStatusDateTIme Optional A2A Validation: [0..1]
<PrtryStsRsn>-</PrtryStsRsn> 4x		ProprietaryStatusReasonCode	ProprietaryStatusReasonCode SSP Error Code According to the FinalStatusCode RJTD Optional A2A Validation: [0..1] The 3 digits alpha numeric SSP Error Codes published in chapter 3 are valid search criteria.
</Sts>		End of PaymentStatus	Optional A2A Validation: [0..n]

name of attribute	format	short description	description
<CdtDbtInd>-</CdtDbtInd>	4!a	Credit or debit indicator	CRDT = Credit Operation is an increase. DBIT = Debit Operation is a decrease. Case - Credits selected: All payments that are credited on one of the selected accounts are returned. - Debits selected: All payments that are debited on one of the selected accounts are returned. - Nothing selected: All payments belonging to the selected accounts are returned no matter if they were credited or debited.
		Optional	Validation:
		A2A	[0..1]
<IntrBkSttlmAmt>		InterbankSettlementAmount	Amount of money transferred between the instructing agent and instructed agent.
		Optional	Validation:
		A2A	*****[0..1] differs from the cash management standard
<ImpldCcyAndAmtRg>		ImpliedCurrencyAndAmountRange	Expresses an amount or an amount range with an explicit debit/credit indicator and where the currency is implied.
		Mandatory	Amount [1..1] CreditDebitIndicator [0..1]
		A2A	Validation: [1..1] in PM only 2 fraction digits are possible this part is for Amount
<Amt>		Amount	Amount in EUR
		Mandatory	Validation:
		A2A	[1..1] in PM only 2 fraction digits are possible
xorEQAmtFrToAmt		choice	
		Mandatory	Validation: choice amongst Amount equal <EQAmt> or Amount from / to <FrAmt>, <FrToAmt>
<FrAmt>		From amount	
		Mandatory	Validation:
		A2A	[1..1]
<BdryAmt>	18n	BoundaryAmount	Amount value of the range limit.
		Mandatory	Validation:
		A2A	[1..1]
<Incl>		Included	Indicates whether the boundary amount is included in the range of amount values.
			Indicates a "Yes" or "No" type of answer for an element.
			MeaningWhenTrue Yes "true" MeaningWhenFalse No "false"
		Mandatory	Validation:
		A2A	[1..1]in PM only true is possible

name of attribute	format	short description	description
</FrAmt>		End FromAmount	End FromAmount
		Mandatory	Validation:
		A2A	[1..1]
<ToAmt>		ToAmount	Upper boundary of a range of amount values.
			BoundaryAmount [1..1] Included [1..1]
		Mandatory	Validation:
		A2A	[1..1]
<BdryAmt>	18n	BoundaryAmount	Amount value of the range limit.
		Mandatory	Validation:
		A2A	[1..1]
<Incl>		Included	Indicates whether the boundary amount is included in the range of amount values.
			Indicates a "Yes" or "No" type of answer for an element.
			MeaningWhenTrue Yes "true" MeaningWhenFalse No "false"
		Mandatory	Validation:
		A2A	[1..1]n PM only false is possible
</ToAmt>		End To Amount	
		Mandatory	Validation:
		A2A	[1..1]
<FrToAmt>		FromToAmount	A range of valid amount values.
			FromAmount [1..1] ToAmount [1..1]
		Mandatory	Validation:
		A2A	[1..1]
<FrAmt>		FromAmount	Lower boundary of a range of amount values.
			BoundaryAmount [1..1] Included [1..1] More than or equal Amount
		Mandatory	Validation:
		A2A	[1..1]
<BdryAmt>	18n	BoundaryAmount	Amount value of the range limit.
		Mandatory	Validation:
		A2A	[1..1] in PM only 2 fraction digits are possible
<Incl>		Included	Indicates whether the boundary amount is included in the range of amount values.
			Indicates a "Yes" or "No" type of answer for an element.
			MeaningWhenTrue Yes "true" MeaningWhenFalse No "false"
		Mandatory	Validation:
		A2A	[1..1] in PM only true is possible

name of attribute	format	short description	description
</FrAmt>		End FromAmount	End FromAmount
		Mandatory	Validation:
		A2A	[1..1]
<ToAmt>		ToAmount	Upper boundary of a range of amount values.
			BoundaryAmount [1..1]
			Included [1..1]
			Less than Amount
		Mandatory	Validation:
		A2A	[1..1]
<BdryAmt>	18n	BoundaryAmount	Amount value of the range limit.
		Mandatory	Validation:
		A2A	[1..1] in PM only 2 fraction digits are possible
<Incl>		Included	Indicates whether the boundary amount is included in the range of amount values.
			Indicates a "Yes" or "No" type of answer for an element.
			MeaningWhenTrue Yes "true"
			MeaningWhenFalse No "false"
		Mandatory	Validation:
		A2A	[1..1] in PM only false is possible
</ToAmt>		End to Amount	End to Amount
		Mandatory	Validation:
		A2A	[1..1]
</FrToAmt>		End From To Amount	End From To Amount
		Mandatory	Validation:
		A2A	[1..1]
<EQAmt>	18n	EqualAmount	The exact value an amount must match to be considered valid.
			Amount (EUR) =
		Mandatory	Validation:
		A2A	[1..1] in PM only 2 fraction digits are possible
/xorEQAmtFrToAmt		End of choice	
		Mandatory	Validation:
			choice amongst Amount equal <EQAmt> or Amount from / to <FrAmt>, <FrToAmt>
</Amt>		End of Amount	End of Amount
		Mandatory	Validation:
		A2A	[1..1]
</ImpldCcyAndAmtRg>		End ImpliedCurrencyandAmount Range	End ImpliedCurrencyandAmount Range
		Mandatory	Validation:
		A2A	[1..1]
</IntrBkSttlmAmt>		End of InterbankSettlementAmount	

name of attribute	format	short description	description
		Optional A2A	Validation: [0..1]
<PmtMtd>		PaymentMethod	Indicates the message or event from which an instruction has been initiated. FINMessageType [1..1] XMLMessageName [1..1] Proprietary [1..1] Instrument [1..1] Search criteria for Payment Type for details on payment origin.
		Optional A2A	Validation: *****[0..6]differs from the cash management standard In PM only <FINMT> or <Prtry> can be used.
xorFINMTPrtry		Choice	Choice amongst <FINMT> and <Prtry>
		Mandatory	Validation:
<FINMT>-</FINMT>	3x	FINMessageType	possible values: 103 202 204
		Mandatory A2A	Validation: [1..1] Possible values are: 202: the result set will include all bookings stemming from an incoming SWIFT FIN message MT202. (MT202, which are created by PM, are not included in this selection criteria.) 103: the result set will include all bookings stemming from an incoming SWIFT FIN message MT103. 204: the result set will include all bookings stemming from an incoming SWIFT FIN message MT204.
<Prtry>-</Prtry>	35x	Proprietary type	Proprietary type of payment origin
		Mandatory A2A	Validation: [1..1]only the values ASXML, T2SXML, TIPSXML, INTERN and ORDER are allowed: ASXML: The result set will include all bookings stemming from an incoming AS XML payments (incl. SBTransferInitiation). T2SXML: The result set will include all bookings stemming from an incoming T2S XML payments INTERN: The result set will include all bookings stemming from internal messages: - Automatic processing by PM, including Standing Orders - Payments delivered from HAM (e.g. Simplified MT202), RM, SF, CRISP, CM ORDER: The result set will include all bookings stemming from current orders sent via ICM. (E.g. Backup Payments. - But not SBTransferInitiation.)
/xorFINMTPrtry		End of Choice	
		Mandatory	Validation:
</PmtMtd>		End of Payment Method	End of Payment Method
		Optional A2A	Validation: [0..6]
<PmtTp>		Payment Type	Type, or nature, of the payment..
		Optional A2A	Validation: *****[0..10]differs from the cash management standard In PM only Proprietary Payment Type is used.

name of attribute	format	short description	description
<Prtry>-</Prtry>		ProprietaryPaymentTypeCode	Proprietary Payment Type REGP = Regular Payment CONP = Connected Payment BACP = Backup Payment LIQP = Liquidity transfer via payments ASYP = Ancillary Systems Payments MANP= mandated payment INTP = interests PDDB = penalties BIDB = billing T2SL = T2S transactions TIPS = TIPS transactions Mandatory A2A
			Validation: [1..1]
</PmtTp>		End Payment Type	End Payment Type Optional A2A
			Validation: [0..10]
<Prty>		Priority	The relative urgency or order of importance that the originator would like the recipient of the payment instruction to apply to the processing of the payment instruction. Code [1..1] PriorityCode PriorityCodeChoice ProprietaryCode [1..1] Max4AlphaNumericText Optional A2A
			Validation: *****[0..3]differs from the cash managemt standard
<Cd>-</Cd>		Priority Code	Specifies the priority level of an event. HIGH = High Priority level is high. LOWW = Low Priority level is low. NORM = Normal Priority level is normal. Priority Mandatory A2A
			Validation: [1..1] here only PriorityCode is used If nothing is selected, all values are searched Normal = NORM is defined in PM as = urgent Priority High = HIGH is defined in PM as = highly urgent Priority Low = LOWW is defined in PM as = normal Priority
</Prty>		End Priority	End Priority Optional A2A
			Validation: [0..3]
<PrcgVldtyTm>		ProcessingValidityTime	Date and time range within which the payment instruction must be processed. Timed payments, Earliest and Latest Debit Time defined by the Instruction Code. If the requestor searches for both values ExecutionDate (<TrfValDt>) and Earliest/LatestdebitTime (<PrcgVldtyTm>) the date within the two elements has to be the same, if not the consequence is, that no payment is found. Optional A2A
			Validation: *****[0..2]differs from the cash management standard

name of attribute	format	short description	description
			The multiplicity of the element "Instr" and "PrcgVldtyTm" must be the same
xorFrDtTmToDtTmDtTmRg		choice Mandatory	choice amongst <FrDtTm>, <ToDtTm> or <DtTmRg> Validation: choice amongst FromDateTime [1..1] ToDateTime [1..1] or DateTimeRange [1..1]
<FrDtTm>-</FrDtTm>	ISODateTime	FromDateTime Mandatory A2A	Date and time at which the range starts. Validation: [1..1]
<ToDtTm>-</ToDtTm>	ISODateTime	ToDateTime Mandatory A2A	Date and time at which the range ends. Validation: [1..1]
<DtTmRg>		DateTimeRange Mandatory A2A	Range of time between a start date and time and an end date and time. Validation: [1..1] the date time range is only possible within one day e.g.<FrDtTm>2006-07-21T08:35:30</FrDtTm><ToDtTm>2006-07-21T09:35:30</ToDtTm>, if the range includes different dates the request will be rejected with an error (see list of error code). If there is a requirement to ask for different dates within the DtTmRg, there has to be initiated further requests.
<FrDtTm>-</FrDtTm>	ISODateTime	FromDateTime Mandatory A2A	Date and time at which the range starts. Validation: [1..1]
<ToDtTm>-</ToDtTm>	ISODateTime	ToDateTime Mandatory A2A	Date and time at which the range ends. Validation: [1..1]
</DtTmRg>		End Date Time Range Mandatory A2A	 Validation: [1..1]
/xorFrDtTmToDtTmDtTmRg		End of choice Mandatory	end of choice amongst <FrDtTm>, or <ToDtTm> or <DtTmRg> Validation: End choice amongst FromDateTime [1..1] ToDateTime [1..1] or DateTimeRange [1..1]
</PrcgVldtyTm>		End of ProcessingValidityTime Optional A2A	End of ProcessingValidityTime Validation: [0..2]
<Instr>-</Instr>		Instruction	Further information related to the processing of the payment instruction. The instruction can relate to a level of service between the bank and the customer, or give instructions to and for specific parties in the payment chain.

name of attribute	format	short description	description
			<p>PBEN = PayTheBeneficiary Beneficiary to be paid only after verification of identity.</p> <p>TFRO = TimeFrom Payment instruction will be valid and eligible for execution from the date and time stipulated.</p> <p>TTIL = TimeTill Payment instruction is valid and eligible for execution until the date and time stipulated. Otherwise, the payment instruction will be rejected.</p> <p>Definition Earliest Debit Time is related to the Codeword (FROTIME) or Latest Debit Time is related to payments with codeword /TILTIME/, /REJTIME/ or /CLSTIME/.</p>
		Optional	Validation:
		A2A	[0..2]in PM only TTIL (Latest Debit Time) and TFRO (Earliest Debit Time) are used to define Timed Payments The multiplicity of the element "Instr" and "PrcgVldtyTm" must be the same
<Txld>-</Txld>	16x	TransactionIdentification 16x	<p>Unique and unambiguous identification of a payment transaction, as assigned by the originator. The payment transaction reference is used for reconciliation or to link tasks relating to the payment transaction.</p> <p>Instruction Identification - TRN in case of a FIN payment - InstructionIdentification in case of AS XML payments</p>
		Optional	Validation:
		A2A	*****[0..1] differs from the cash management standard
<EndToEndId>-</EndToEndId>	16x	EndToEndIdentification	<p>Unique and unambiguous identification of a payment transaction, as assigned by any of the parties on the initiating side, that will be passed on throughout the entire end-to-end chain</p> <p>End to End Identification - Related TRN (Field 21 in case of FIN messages) - EndToEndIdentification in case of AS XML payments</p>
		Optional	Validation:
		A2A	*****[0..1] differs from the cash management standard
<Pties>		Parties	<p>PaymentTransactionParties needed for selection of Selection SWIFT FIN Fields</p>
		Optional	Validation:
		A2A	*****[0..1] differs from the cash management standard If GoA manager selects SWIFT fields, there are only displayed his own accounts as participant.
<DbtrAgt>		Debtor Agent	<p>Debtor Agent</p> <p>in SSP only <Mmblid> with BICFI possible</p>
		Optional	Validation:
		A2A	[0..1]
</FinInstnId>		End of Financial Institution Identification	End of Financial Institution Identification
		Mandatory	Validation:
		A2A	[1..1]
<BICFI>-</BICFI>	4!a2!a2!c3!c	BICFIIdentifier	<p>BICFIIdentifier</p> <p>F52, ordering institution in case of FIN payment / or FirstAgent BIC of AS XML message</p>
		Mandatory	Validation:
		A2A	[1..1]

name of attribute	format	short description	description
</FinInstnId>		End of Financial Institution Identification Mandatory A2A	End of Financial Institution Identification Validation: [1..1]
</DbtrAgt>		End of Debtor Agent Optional A2A	End of Debtor Agent Validation: [0..1]
<InstdRmbrsmntAgt>		InstructedReimbursementAgent Optional A2A	Receivers Correspondent Validation: [0..1]
</FinInstnId>		Financial Institution Identification Mandatory A2A	Financial Institution Identification Validation: [1..1]
<BICFI></BICFI>	4!a2!a2!c3!c	BICFIIdentifier Mandatory A2A	BICFIIdentifier F54, receivers correspondent in case of FIN payment / or Debtor BIC of AS XML message Validation: [1..1]
</FinInstnId>		End of Financial Institution Identification Mandatory A2A	End of Financial Institution Identification Validation: [1..1]
</InstdRmbrsmntAgt>		End of InstructedReimbursementAgent Optional A2A	Validation: [0..1]
<IntrmyAgt>		IntermediaryAgent Optional A2A	Intermediary party in the settlement chain, eg, a party from which the Sender received the cash, when other than the originator. Validation: [0..1]
</FinInstnId>		Financial Institution Identification Mandatory A2A	Financial Institution Identification Validation: [1..1]
<BICFI></BICFI>	4!a2!a2!c3!c	BICFIIdentifier Mandatory A2A	BICFIIdentifier F56, intermediary institution in case of FIN payment / or AS counterpart BIC (in case of cross-AS settlement) of AS XML message Validation: [1..1]
</FinInstnId>		End of Financial Institution Identification Mandatory A2A	End of Financial Institution Identification Validation: [1..1]
</IntrmyAgt>		End of IntermediaryAgent Optional	Validation:

name of attribute	format	short description	description
		A2A	[0..1]
<CtrAgt>		Creditor Agent	Provides details about a system and about a member of a system
		Optional	Validation:
		A2A	[0..1]
<FinInstnId>		Financial Institution Identification	Financial Institution Identification
		Mandatory	Validation:
		A2A	[1..1]
<BICFI>-</BICFI>	4!a2!a2!c3!c	BICFIIdentifier	BICFIIdentifier
			F57, account with institution in case of FIN payment / or FinalAgent BIC of AS XML message
		Mandatory	Validation:
		A2A	[1..1]
</FinInstnId>		End of Financial Institution Identification	End of Financial Institution Identification
		Mandatory	Validation:
		A2A	[1..1]
</CtrAgt>		End of Creditor Agent	End of Creditor Agent
		Optional	Validation:
		A2A	[0..1]
<Ctr>		Creditor	Provides details about a system and about a member of a system.
		Optional	Validation:
		A2A	[0..1]
<FinInstnId>		Financial Institution Identification	Financial Institution Identification
		Mandatory	Validation:
		A2A	[1..1]
<BICFI>-</BICFI>	4!a2!a2!c3!c	BICFIIdentifier	BICFIIdentifier
			return F58, beneficiary institution in case of FIN payment / or Creditor BIC of AS XML message
		Mandatory	Validation:
		A2A	[1..1]
</FinInstnId>		End of Financial Institution Identification	End of Financial Institution Identification
		Mandatory	Validation:
		A2A	[1..1]
</Ctr>		End of Creditor	
		Optional	Validation:
		A2A	[0..1]
</Pties>		End of Parties	End Selection SWIFT FIN Fields
		Optional	Validation:
		A2A	[0..1]
</PmtSch>		End of PaymentSearch	End of PaymentSearch
		Optional	Validation:

name of attribute	format	short description	description
		A2A	[0..1]
<AcctNtrySch>		AccountEntrySearch	Defines the criteria which are used to search for a cash entry.
		Optional	Validation:
		A2A	[0..1]
<AcctId>		Account Identification	Account Identification RTGSAccount /Sub-Account If <AcctId> is not stated, the requestor (e.g. GoA manager, CB) can see all payments of participants he is responsible for (according the other selection criteria) else he gets all payments related to the selected account(s).
		Optional	Validation:
		A2A	****[0..n] If the requestor asks for debit/credit indication he has to query payments for a single account. A multiple occurrence of <AcctId> is not allowed in that case.
<EQ>		AccountIdentificationChoice	AccountIdentificationChoice
		Mandatory	Validation:
		A2A	[1..1] only <DmstAcct><Id> is used
<Othr>		GenericAccountIdentification	GenericAccountIdentification
		Mandatory	Validation:
		A2A	[1..1]
<Id>-</Id>	34x	Identification	Name or number assigned by an entity to enable recognition of that entity, eg, account identifier. Account ID
		Mandatory	Validation:
		A2A	[1..1] depending on the user group: - CB: All accounts the CB is responsible for. Additionally RTGS and sub accounts of Group of Accounts members the CB is NOT responsible for if she is responsible for the group's manager. And all RTGS and sub accounts linked to an Ancillary System the CB is responsible for and which belong to a Settlement Bank the CB is NOT responsible for. - GoA manager (Virtual Account/Consolidated Information): All RTGS accounts of the group members and the related sub-accounts - Ancillary System: All technical account(s), mirror account(s), related settlement bank RTSG and sub account(s) and guarantee account(s), which are connected to the ancillary system - Participant: The RTGS account and the sub-accounts (if exists) of the requestor
<Othr>		GenericAccountIdentification	GenericAccountIdentification
		Mandatory	Validation:
		A2A	[1..1]
</EQ>		End of AccountIdentificationChoice	End of search for one or more accounts based on exact identification of the account(s).
		Mandatory	Validation:
		A2A	[1..1]
</AcctId>		End of Account Identification	End Account Identification
		Optional	Validation:

name of attribute	format	short description	description	
		A2A	[0..n]	
<NtryDt>		Entry Date / Time	Date and time at which an entry is posted to an account on the account servicer's books. Entry Date Time	
		Optional	Validation:	
		A2A	[0..n]	
<DtTmSch>		DateTimePeriodChoice	A choice between various date time patterns.	
			FromDateTime [1..1] ToDateTime [1..1] DateTimeRange [1..1]	DateTimePeriodChoice DateTimePeriodChoice DateTimePeriodChoice
		Mandatory	Validation:	
		A2A	[1..1]	
xorDtTmSch		DateTimeSearch	DateTimeSearch	
			FromDateTime [1..1] ToDateTime [1..1] DateTimeRange [1..1]	
		Mandatory	Validation:	
		A2A		
<FrDtTm>-</FrDtTm>	ISODateTime	FromDateTime	Date and time at which the range starts.	
		Mandatory	Validation:	
		A2A	[1..1]	
<ToDtTm>-</ToDtTm>	ISODateTime	ToDateTime	Date and time at which the range ends.	
		Mandatory	Validation:	
		A2A	[1..1]	
<DtTmRg>		DateTimeRange	Range of time between a start date and time and an end date and time.	
		Mandatory	Validation:	
		A2A	[1..1]	
<FrDtTm>-</FrDtTm>	ISODateTime	FromDateTime	Date and time at which the range starts.	
		Mandatory	Validation:	
		A2A	[1..1]	
<ToDtTm>-</ToDtTm>	ISODateTime	ToDateTime	Date and time at which the range ends.	
		Mandatory	Validation:	
		A2A	[1..1]	
</DtTmRg>		End of DateTimeRange		
		Mandatory	Validation:	
		A2A	[1..1]	
/xorDtTmSch		End Date Time Choice	end Date Time Choice	
		Mandatory	Validation:	
		A2A		
</DtTmSch>		End of DateTimePeriodChoice	End of DateTimePeriodChoice	
		Mandatory	Validation:	

name of attribute	format	short description	description
		A2A	[1..1]
</NtryDt>		End of Entry Date / Time	
	Optional		Validation: [0..n]
		A2A	
</AcctNtrySch>		End AccountEntrySearch	End of defines the criteria which are used to search for a cash entry.
	Optional		Validation: [0..1]
		A2A	
</SchCrit>		End of SearchCriteria	End of SearchCriteria
	Optional		Validation: [0..1]
		A2A	
<RtrCrit>		ReturnCriteria	Defines the Transaction criteria used to report on.
	Optional		Validation: [0..1] It depends on the occurrence of element ReturnCriteria whether the default criteria are used or not. Only if the element is not present in the request, the default values apply. The usage of ReturnCriteria overwrites the default and changes the appearance of the report. Only the information related to the indicators with value "true" will be reported. Indicators not mentioned are considered as "false". In some cases the information related to selected return criteria might be unavailable as a consequence the corresponding element will not be part of the ReturnTransaction.
		A2A	StatementReport <StrmRpt> is not used in PM
<PmtToRtrCrit>		PaymentToReturnCriteria	Destination of the payment (be it a member or a system or both).
	Optional		Validation: [0..1] <SysIdInd>, <CtryInd> and <AcctIdInd> not used in PM
		A2A	
<MmblIdInd>		MemberIdentificationIndicat or Mandatory	Indicates whether the member identification is requested. default = true Validation: ****[1..1]
		A2A	
</PmtToRtrCrit>		End PaymentToReturnCriteria	End of destination of the payment (be it a member or a system or both).
	Optional		Validation: [0..1]
		A2A	
<PmtFrRtrCrit>		PaymentFromReturnCriteri	Origin of the payment (be it a member or a system or both).
	Optional		Validation: [0..1] <SysIdInd>, <CtryInd> and <AcctIdInd> not used in PM
		A2A	
<MmblIdInd>		MemberIdentificationIndicat or Mandatory	Indicates whether the member identification is requested. default = true Validation: ****[1..1]
		A2A	
</PmtFrRtrCrit>		End PaymentFromReturnCriteri	End of origin of the payment (be it a member or a system or both).

name of attribute	format	short description	description
		Optional A2A	Validation: [0..1]
<AcctCshNtryRtrCrit>		AccountCashEntryReturnCriteria Optional A2A	Defines the criteria used to report on the cash entry. Validation: [0..1]
<NtryDtInd>		EntryDateIndicator Mandatory A2A	Indicates whether the entry date is requested. default = true Validation: ****[1..1]
</AcctCshNtryRtrCrit>		End AccountCashEntryReturnCriteria Optional A2A	End of defines the criteria used to report on the cash entry. Validation: [0..1]
<PmtRtrCrit>		PaymentReturnCriteria Optional A2A	Defines the criteria used to report on the payment. Validation: [0..1]
<MsgIdInd></MsgIdInd>		MessageIdIndicator Optional A2A	Indicates whether the MessageId is requested. return of SSP Business Case ID default = true This ID can be used to match reverse bookings (with reversal reason) to the original payments (where no error code is stated). Or to link duplicate payment entries with the first settled booking. Validation: [0..1]
<InstrStsRtrCrit>		InstructionStatusReturnCriteria Optional A2A	Indicates whether the instruction status is requested. return payment status Validation: [0..1]
<PmtInstrStsInd>		PaymentInstructionStatusIndicator Mandatory A2A	Indicates if the instruction status is requested. return status default = true Validation: [1..1]
<PmtInstrStsDtTmInd>		PaymentInstructionStatusDateTimeIndicator Optional A2A	Indicates if the status date and time are requested. return settlement time default = true Validation: [0..1]
<PmtInstrStsRsnInd>		PaymentInstructionStatusReasonIndicator Optional A2A	Indicates if the status reason is requested. return error code default = true Validation: [0..1]
</InstrStsRtrCrit>		End	End of indicates whether the instruction status is

name of attribute	format	short description	description
		InstructionStatusReturnCriteria	requested.
	Optional	A2A	Validation: [0..1]
<CdtDbtInd>		Credit Debit Indicator	Credit Debit Indicator
			Indicates whether a Credit Debit Code is requested. default = false
	Optional	A2A	Validation: [0..1] Indicator might only be set to 'true' if the requestor has only access to a single PM account or if in AccountEntrySearch it is given only one AccountIdentification as search criterion.
<IntrBkSttlmAmtInd>- </IntrBkSttlmAmtInd>		InterBankSettlementAmountIndicator	Indicates whether the InterBankSettlementAmount is requested. return amount
			default = true
	Optional	A2A	Validation: [0..1]
<PrtyInd>		PriorityIndicator	Indicates whether the payment priority is requested. return priority
			default = true
	Optional	A2A	Validation: [0..1]
<PrcgVldtyTmInd>		ProcessingValidityTimeIndicator	Indicates whether the processing validity time is requested. return timed payments
			default = true
	Optional	A2A	Validation: [0..1]
<InstrCpyInd>		InstructionCopyIndicator	Indicates whether the instruction copy is requested. In SSP 10000x
			used to return the complete copy of the payment message (SWIFT FIN string of the selected message including Header and Trailer or internal message or XML message) both messages will returned unformatted. In case of receiving an original XML message, SSP use a CDATA section, so that the text will be ignored by the parser, with the effect, that the markup signs <> will be ignored too. From a technical point of view it seems to be a string. The client A2A application have to unpack this CDATA section. This will look as follows: <InstrCpy><![CDATA[<Document xmlns="urn:swift:xsd:\$pain.998.001.01"><pain.998.001.01><PrtryDt><Tp>ASTransferInitiation</Tp>...</PrtryDt></pain.998.001.01></Document>]]></InstrCpy>
			default = true
			In case a GoA manager sends the request for group members' payments (or a CB is working as GoA manager = has selected an group account she is not responsible for) this return criterion has to be used with value 'false'.
	Optional	A2A	Validation: [0..1]

name of attribute	format	short description	description
<PmtTpInd>		PaymentTypeIndicator	Indicates whether the payment type is requested. return payment type default = true
		Optional	Validation:
		A2A	[0..1]
<TxIdInd>-</TxIdInd>		TransactionIdIndicator	Indicates whether the TransactionId is requested. return TRN in case of a FIN payment / InstructionIdentification in case of AS XML payments default = true
		Optional	Validation:
		A2A	[0..1]
<IntrBkSttlmDtInd>		InterBankSettlementDateIndicator	Indicates whether the InterBankSettlementDate is requested. return execution date / value date default = true
		Optional	Validation:
			[0..1]
<EndToEndIdInd>		EndToEndIdIndicator	Indicates whether the EndToEndIdIndicator is requested. return F21 RelatedReference in case of a FIN payment / EndToEndIdentification in case of AS XML payments default = true
		Optional	Validation:
		A2A	[0..1]
<PmtMtdInd>		PaymentMethod Indicator	PaymentMethod Indicator MeaningWhenTrue Requested MeaningWhenFalse Not Requested return message type default = true
		Optional	Validation:
		A2A	[0..1]
<DbtrAgtInd>-</DbtrAgtInd>		DebtorAgentIndicator	Indicates whether the DebtorAgent is requested. return F52, ordering institution / or FirstAgent BIC of AS XML message default = true In case a GoA manager sends the request for group members' payments (or a CB is working as GoA manager = has selected an group account she is not responsible for) this return criterion has to be used with value 'false'.
		Optional	Validation:
		A2A	[0..1]
<InstdRmbrsmntAgtInd>-</InstdRmbrsmntAgtInd>		InstructedReimbursementAgentIndicator	Indicates whether the InstructedReimbursementAgent is requested return F54, receivers correspondent / or Debtor BIC of AS XML message default = true In case a GoA manager sends the request for group members' payments (or a CB is working as GoA manager = has selected an group account she is not responsible for) this return criterion has to be used with value 'false'.
		Optional	Validation:

name of attribute	format	short description	description
		A2A	[0..1]
<IntrmyInd></IntrmyInd>		IntermediaryIndication	Indicates whether the Intermediary Indicator is requested. MeaningWhenTrue: :Requested MeaningWhenFalse: Not Requested return F56, intermediary institution / or AS counterpart BIC (in case of cross-AS settlement) of AS XML message default = true In case a GoA manager sends the request for group members' payments (or a CB is working as GoA manager = has selected an group account she is not responsible for) this return criterion has to be used with value 'false'. Validation: [0..1]
		Optional A2A	
<CdtrAgtInd></CdtrAgtInd>		CreditorAgentIndicator	Indicates whether the CreditorAgent is requested return F57, account with institution / or FinalAgent BIC of AS XML message default = true In case a GoA manager sends the request for group members' payments (or a CB is working as GoA manager = has selected an group account she is not responsible for) this return criterion has to be used with value 'false'. Validation: [0..1]
		Optional A2A	
<CdtrInd></CdtrInd>		CreditorIndicator	Indicates whether the Creditor is requested return F58, beneficiary institution / or Creditor BIC of AS XML message default = true In case a GoA manager sends the request for group members' payments (or a CB is working as GoA manager = has selected an group account she is not responsible for) this return criterion has to be used with value 'false'. Validation: [0..1]
		Optional A2A	
</PmtRtrCrit>		End PaymentReturnCriteria	End of defines the criteria used to report on the payment. Validation: [0..1]
		Optional A2A	
</RtrCrit>		End of ReturnCriteria	End of ReturnCriteria Validation: [0..1]
		Optional A2A	
</NewCrit>		End of NewCriteria	End of NewCriteria Validation: [1..1]
		Mandatory A2A	
/xorQryNmNewCrit		End choice amongst	end choice amongst TransactionCriteriaDefinitionChoice Validation:
		Mandatory	
</TxCrit>		End of Transaction query criteria.	

name of attribute	format	short description	description
		Optional A2A	Validation: [0..1]
</TxQryDef>		End of Transaction query definition Optional A2A	Validation: [0..1]
</GetTx>		End of Messagename for GetTransaction Optional A2A	Validation:

Error Codes:

Order	Error code				Error Text / Validation/ Remark
	SSP	Y-copy	V-shape	XML	
1	X41			1401	<p>Error Text: No permission. RBAC User role(s) are not sufficient.</p> <p>Validation: RBAC role name "APPLICATE", "APPLICBTE", "APPLICSTE" or "APPLIASTE" are required.</p> <p>Remark: checked by ICM / ReturnTransaction</p>
2	X42			1402	<p>Error Text: No authorisation. User is not allowed acting on behalf of another participant.</p> <p>Validation: AcctId/DmstAcct/Id value must indicate a sub-account or a main account that belongs to the credit institution itself or to a participant the credit institution is entitled to act on behalf of</p> <p>Remark: checked by ICM/ ReturnTransaction</p>
3	X47			1407	<p>Error Text: No authorisation. User is not allowed acting on behalf of another Participant as Central Bank</p> <p>Validation: AcctId/DmstAcct/Id value must indicate a main or sub-account that belongs. . . to the requesting central bank itself, to a participant the CB is responsible for, to a member of a GoA where the CB is responsible for the group's manager or to a Settlement Bank of an Ancillary System the CB is responsible for. (The CB does not need to be responsible for the Settlement Bank or the GoA member.)</p> <p>Remark: checked by ICM/ ReturnTransaction</p>
4	X45			1405	<p>Error Text: No authorisation or rather interaction not possible. User is not allowed acting on behalf of another participant as Group of Account manager</p> <p>Validation: AcctId/DmstAcct/Id value must indicate a sub-account or a main account that belongs to a member of the group of accounts the participant is manager of</p> <p>Remark: checked by ICM/ ReturnTransaction</p>
5	X35			1305	<p>Error Text: The query name is not related to a previous query.</p> <p>Validation: QryNm value must indicate a previous query</p> <p>Remark: checked by ICM/ ReturnTransaction</p>
8	P10			P010	<p>Error Text: The multiplicity of the element "Instr" and "PrcgVldtyTm" is unequal</p> <p>Validation: The multiplicity of the element "Instr" and "PrcgVldtyTm" must be the same</p> <p>Remark: ReturnTransaction</p>
9	P06			P006	<p>Error Text: If you want to select SWIFT fields, you must select your own accounts.</p> <p>Validation: It's not possible for the GoA manager to search for <PmtTxPty> (SWIFT fields), GoA manager is only able to select his own accounts as participant.</p> <p>Remark: ReturnTransaction</p>
10	P04			P004	<p>Error Text: If you want to select SWIFT fields in your preferences, you must select your own accounts.</p> <p>Validation: It's not possible for the GoA manager to search for (SWIFT fields within the ReturnCriteria): <FrstAgtInd>, <InstrCpy>, <InstdAgtCrsptdInd>, <IntrmyInd>, <FnlAgtInd>, <CdrtrInd>The GoA manager is only able to select his own accounts as participant.</p> <p>Remark: ReturnTransaction</p>
11	P86			P116	<p>Error Text: Only one date for Execution Date is allowed</p> <p>Validation: PrcgVldtyTm/ DtTmRg / FrDtTm and /ToDtTm: the date instruction within FrDtTm and ToDtTm must be the same.</p> <p>Remark: checked by ICM / ReturnTransaction</p>

Order	Error code				Error Text / Validation/ Remark
	SSP	Y-copy	V-shape	XML	
12	P07			P007	<p>Error Text: If you want to search for PaymentInstructionStatusDateTime, you have to send one request per payment status.</p> <p>Validation: It's not possible to take into account search criteria PaymentInstructionStatusDateTime <PmtInstrStsDtTm> more than once per request. Thus if element InstructionStatus is repeated PaymentInstructionStatusDateTime can only apply to a single status.</p> <p>Remark: checked by ICM / ReturnTransaction</p>
13	862	C2	TM01	2862	<p>Error Text: Request out of cut-off time</p> <p>Validation: Possibility to use this function during the current phase of business day.</p> <p>Remark: ReturnTransaction</p>
14	P13			P013	<p>Error Text: No payment found</p> <p>Validation: existing payment</p> <p>Remark: ReturnTransaction</p>
15	P13			P013	<p>Error Text: No payment found</p> <p>Validation: PrtryRef does exist and is valid</p> <p>Remark: ReturnTransaction</p>
16	P13			P013	<p>Error Text: No payment found</p> <p>Validation: Execution Date current and future (5 future dates are possible)</p> <p>Remark: ReturnTransaction</p>
18	P99			P099	<p>Error Text: No authorisation. The GoA Manager has no longer access to payments of an excluded Participant, which was previously member of his GoA.</p> <p>Validation: The Group of Accounts Manager has no longer access to payments of an excluded participant, which was previously member of his Group of Accounts. The validation will also be taken into account if a CB/SSP user works on behalf of the GoA Manager. The validation does not concern the access on the GoA Managers RTGS Account, if he is excluded.</p> <p>Remark:</p>
19	P50			P050	<p>Error Text: If element <PmtInstrStsDtTm> is used, within <PmtInstrSts> it is only allowed to search for <FnlSts>STLD</FnlSts>.</p> <p>Validation: If element <PmtInstrStsDtTm> (Settlement Time) is used, within <PmtInstrSts> it is only allowed to search for <FnlSts>STLD</FnlSts> (settled transactions).</p> <p>Remark: checked by ICM / ReturnTransaction</p>
20	P20			P020	<p>Error Text: If you want to select SWIFT fields, select accounts you are responsible for.</p> <p>Validation: A CB can search for payments of participants belonging to a Group of Accounts if she is responsible for the manager even if none of the booking accounts belongs to her area. If the query is related to such an account the CB is not responsible for, the requestor's rights are reduced to those of the GoA manager. Thus a SWIFT field has not to be used as search criterion (cp. validation 9).</p> <p>Remark: checked by ICM / ReturnTransaction</p>
21	P21			P021	<p>Error Text: Return criteria SWIFT fields can only be selected if the query refers to accounts you are responsible for.</p> <p>Validation: A CB can search for payments of participants belonging to a Group of Accounts if she is responsible for the manager even if none of the booking accounts belongs to her area. If the query is related to such an account the CB is not responsible for, the requestor's rights are reduced to those of the GoA manager. Thus</p>

Order	Error code				Error Text / Validation/ Remark
	SSP	Y-copy	V-shape	XML	
					<p>following return criteria indicators must not be set to 'true' (cp. validation 10): <FrstAgtInd>, <InstrCpyInd>, <InstdAgtCrspdtInd>, <IntrmyInd>, <FnlAgtInd>, <CdtrlInd>.</p> <p>Remark: checked by ICM / ReturnTransaction</p>
22	P34			P034	<p>Error Text: Search criteria PmtFr/Mmbld and PmtTo/Mmbld are only allowed once per request.</p> <p>Validation: If search for PmtFr/Mmbld is used this criterion must not be repeated.</p> <p>Remark: checked by ICM / ReturnTransaction</p>
23	P34			P034	<p>Error Text: Search criteria PmtFr/Mmbld and PmtTo/Mmbld are only allowed once per request.</p> <p>Validation: If search for PmtTo/Mmbld is used this criterion must not be repeated.</p> <p>Remark: checked by ICM / ReturnTransaction</p>
24	P35			P035	<p>Error Text: Country code(s) in PmtFr/Ctry and PmtTo/Ctry must not differ.</p> <p>Validation: If PmtFr includes a counterpart country code (or a list of countries) differing country code(s) are not allowed in PmtTo but they can be left out (to shorten the request message). The same is meant for the opposite: If counterpart country codes are filled in PmtTo there is no need for country codes in PmtFr but if they are also entered there the lists must not differ.</p> <p>Remark: checked by ICM / ReturnTransaction</p>
25	P37			P037	<p>Error Text: You cannot set CreditDebitIndicator to TRUE if your query applies to several accounts.</p> <p>Validation: Credit/debit indication may only be requested for ReturnTransaction if the requestor accesses a single account (because he has only a single account or he has limited the search to a single account in element AccountEntrySearch).</p> <p>Remark: checked by ICM / ReturnTransaction</p>

GetTransaction_PM_1

Scope: GetTransaction sent to request information on a single booking identified via SSP Booking ID - with different indicators within the Transaction Return Criteria

MessageName for GetTransaction	<GetTx>
Message Header	<MsgHdr>
Message Identification	<MsgId>ABC123</MsgId>
Transaction query definition	<TxQryDef>
Transaction query criteria.	<TxCrit>
End of Message Header	</MsgHdr>
NewCriteria	<NewCrit>
SearchCriteria	<SchCrit>
PaymentSearch	<PmtSch>
PaymentIdentification	<PmtId>
ProprietaryId	<PrtryId>123456</PrtryId>
EndPaymentIdentification	</PmtId>
End of PaymentSearch	</PmtSch>
End of SearchCriteria	</SchCrit>
ReturnCriteria	<RtrCrit>
PaymentToReturnCriteria	<PmtToRtrCrit>
MemberIdentificationIndicator	<MmbldInd>true</MmbldInd>
End PaymentToReturnCriteria	</PmtToRtrCrit>
PaymentFromReturnCriteria	<PmtFrRtrCrit>
MemberIdentificationIndicator	<MmbldInd>true</MmbldInd>
End PaymentFromReturnCriteria	</PmtFrRtrCrit>
PaymentReturnCriteria	<PmtRtrCrit>
MessageIdIndicator	<MsgIdInd>true</MsgIdInd>
Credit Debit Indicator	<CdtDbtInd>true</CdtDbtInd>
InterBankSettlementAmountIndicator	<IntrBkSttlmAmtInd>true</IntrBkSttlmAmtInd>
PriorityIndicator	<PrtyInd>true</PrtyInd>
PaymentTypeIndicator	<PmtTplInd>true</PmtTplInd>
TransactionIdIndicator	<TxIdInd>true</TxIdInd>
InterBankSettlementDateIndicator	<IntrBkSttlmDtInd>true</IntrBkSttlmDtInd>
EndToEndIdIndicator	<EndToEndIdInd>true</EndToEndIdInd>
PaymentMethod Indicator	<PmtMtdInd>true</PmtMtdInd>
DebtorAgentIndicator	<DbtrAgtInd>true</DbtrAgtInd>
InstructedReimbursementAgentIndicator	<InstdRmbrsmntAgtInd>true</InstdRmbrsmntAgtInd>
IntermediaryIndication	<IntrmyInd>true</IntrmyInd>
CreditorAgentIndicator	<CdtrAgtInd>true</CdtrAgtInd>
CreditorIndicator	<CdtrInd>true</CdtrInd>
End PaymentReturnCriteria	</PmtRtrCrit>
End of ReturnCriteria	</RtrCrit>
End of NewCriteria	</NewCrit>
End of Transaction query criteria.	</TxCrit>
End of Transaction query definition	</TxQryDef>
End of MessageName for GetTransaction	</GetTx>

GetTransaction_PM_2

Scope: GetTransaction: via LongBusinessIdentification without Transaction Return Criteria

MessageName for GetTransaction	<GetTx>
Message Header	<MsgHdr>
Message Identification	<MsgId>ABC123</MsgId>
End of Message Header	</MsgHdr>
Transaction query definition	<TxQryDef>
Transaction query criteria.	<TxCrit>
NewCriteria	<NewCrit>
SearchCriteria	<SchCrit>
PaymentSearch	<PmtSch>
PaymentIdentification	<PmtId>
LongBusinessIdentification	<LngBizId>
TransactionIdentification 16x	<TxId>ABC1234</TxId>
InterbankSettlementAmount	<IntrBkSttlmAmt>100.15</IntrBkSttlmAmt>
Value date	<IntrBkSttlmDt>2007-02-25</IntrBkSttlmDt>
PaymentMethod	<PmtMtd>
FINMessageType	<FINMT>202</FINMT>
End of Payment Method	</PmtMtd>
Instructing Agent	<InstgAgt>
Financial Institution Identification	<FinInstnId>
BICFIIdentifier	<BICFI>DEUTDEFFXXX</BICFI>
End of Financial Institution Identification	</FinInstnId>
End of Instructing Agent	</InstgAgt>
Instructed Agent	<InstdAgt>
Financial Institution Identification	<FinInstnId>
BICFIIdentifier	<BICFI>MARKDEFFXXX</BICFI>
End of Financial Institution Identification	</FinInstnId>
End of Instructed Agent	</InstdAgt>
EndToEndIdentification	<EndToEndId>ABC12134</EndToEndId>
End LongBusinessIdentification	</LngBizId>
EndPaymentIdentification	</InstrRef>
End of PaymentSearch	</PmtSch>
End of SearchCriteria	</SchCrit>
End of NewCriteria	</NewCrit>
End of Transaction query criteria.	</TxCrit>
End of Transaction query definition	</TxQryDef>
End of MessageName for GetTransaction	</GetTx>

GetTransaction_PM_3

Scope: GetTransaction without payment instruction reference, search for different payment details:

BIC Sender + BIC Receiver

<PmtSch> PaymentSearch:
 - ExecutionDate
 - Amount
 - Priority: urgent payments

Message name for GetTransaction	<GetTx>
Message Header	<MsgHdr>
Message Identification	<MsgId>ABC123</MsgId>
End of Message Header	</MsgHdr>
Transaction query definition	<TxQryDef>
Transaction query criteria.	<TxCrit>
NewCriteria	<NewCrit>
SearchCriteria	<SchCrit>
PaymentTo	<PmtTo>
Member Identification	<Mmbld>
Financial Institution Identification	<FinInstnId>
BICFIIdentifier	<BICFI>DEUTDEFFXXX</BICFI>
End of Financial Institution Identification	</FinInstnId>
End of Member Identification	</Mmbld>
End PaymentTo	</PmtTo>
Payment From	<PmtFr>
Member Identification	<Mmbld>
Financial Institution Identification	<FinInstnId>
BICFIIdentifier	<BICFI>DEUTDEFFXXX</BICFI>
End of Financial Institution Identification	</FinInstnId>
End of Member Identification	</Mmbld>
End Payment From	</PmtFr>
PaymentSearch	<PmtSch>
RequestedExecutionDate	<ReqdExctnDt>
DateSearchChoice	<DtSch>
FromToDate	<FrToDt>
FromDate	<FrDt>2008-07-21</FrDt>
ToDate	<ToDt>2008-07-22</ToDt>
End FromToDate	</FrToDt>
End of Date Search	</DtSch>
End of RequestedExecutionDate	</ReqdExctnDt>
InterbankSettlementAmount	<InstdAmt>
ImpliedCurrencyAndAmountRange	<ImpldCcyAndAmtRg>
Amount	<Amt>
EqualAmount	<EQAmt>500000.00</EQAmt>
End of Amount	</Amt>
End ImpliedCurrencyandAmount Range	</ImpldCcyAndAmtRg>
End of InterbankSettlementAmount	</IntrBkSttlmAmt>
Priority	<Prty>
Priority Code	<Cd>NORM</Cd>
End Priority	</Prty>
End of PaymentSearch	</PmtSch>
End of SearchCriteria	</SchCrit>
ReturnCriteria	<RtrCrit>
PaymentToReturnCriteria	<PmtToRtrCrit>

MemberIdentificationIndicator					<MmbldInd>true</MmbldInd>
End PaymentToReturnCriteria					</PmtToRtrCrit>
PaymentFromReturnCriteria					<PmtFrRtrCrit>
MemberIdentificationIndicator					<MmbldInd>true</MmbldInd>
End PaymentFromReturnCriteria					</PmtFrRtrCrit>
PaymentReturnCriteria					<PmtRtrCrit>
InterBankSettlementAmountIndicator					<IntrBkSttlmAmtInd>true</IntrBkSttlmAmtInd>
PriorityIndicator					<PrtyInd>true</PrtyInd>
InterBankSettlementDateIndicator					<IntrBkSttlmDtInd>true</IntrBkSttlmDtInd>
End PaymentReturnCriteria					</PmtRtrCrit>
End of ReturnCriteria					</RtrCrit>
End of NewCriteria					</NewCrit>
End of Transaction query criteria.					</TxCrit>
End of Transaction query definition					</TxQryDef>
End of Messagename for GetTransaction					</GetTx>

GetTransaction_PM_4

Scope: GetTransaction without payment instruction reference. Request with Payment Search details <PmtSch>

MessageName for GetTransaction	<GetTx>
Message Header	<MsgHdr>
Message Identification	<MsgId>ABC1234</MsgId>
End of Message Header	</MsgHdr>
Transaction query definition	<TxQryDef>
Transaction query criteria.	<TxCrit>
NewCriteria	<NewCrit>
SearchCriteria	<SchCrit>
PaymentSearch	<PmtSch>
RequestedExecutionDate	<ReqdExctnDt>
DateSearchChoice	<DtSch>
EqualDate	<EQDt>2002-07-28</EQDt>
End of Date Search	</DtSch>
End of RequestedExecutionDate	</ReqdExctnDt>
PaymentIdentification	<PmtId>
ProprietaryId	<PrtryId>345</PrtryId>
EndPaymentIdentification	</PmtId>
PaymentStatus	<InstrSts>
PaymentStatusCode	<PmtInstrSts>
FinalStatus	<FnlSts>RJTD</FnlSts>
End PaymentStatusCode	</PmtInstrSts>
End of PaymentStatus	</Sts>
InterbankSettlementAmount	<IntrBkSttlmAmt>
ImpliedCurrencyAndAmountRange	<ImpldCcyAndAmtRg>
Amount	<Amt>
FromToAmount	<FrToAmt>
FromAmount	<FrAmt>
BoundaryAmount	<BdryAmt>1000.00</BdryAmt>
Included	<Incl>>true</Incl>
End FromAmount	</FrAmt>
ToAmount	<ToAmt>
BoundaryAmount	<BdryAmt>5000.00</BdryAmt>
Included	<Incl>>false</Incl>
End to Amount	</ToAmt>
End From To Amount	</FrToAmt>
End of Amount	</Amt>
End ImpliedCurrencyandAmount Range	</ImpldCcyAndAmtRg>
End of InterbankSettlementAmount	</IntrBkSttlmAmt>
Credit or debit indicator	<CdtDbtInd>CRDT</CdtDbtInd>
PaymentMethod	<PmtMtd>
FINMessageType	<FINMT>202</FINMT>
End of Payment Method	</PmtMtd>
Priority	<Prty>
Priority Code	<Cd>HIGH</Cd>
End Priority	</Prty>
Instruction	<Instr>TFRO</Instr>
Payment Type	<PmtTp>
ProprietaryPaymentTypeCode	<Prtry>REGP</Prtry>
End Payment Type	</PmtTp>

TransactionIdentification 16x	<Txld>ABC1234</Txld>
EndToEndIdentification	<EndToEndId>ABCFG6709</EndToEndId>
Parties	<Pties>
Debtor Agent	<DbtrAgt>
End of Financial Institution Identification	</FinInstnId>
BICFIIdentifier	<BICFI>DEUTDEFFXXX</BICFI>
End of Financial Institution Identification	</FinInstnId>
End of Debtor Agent	</DbtrAgt>
InstructedReimbursementAgent	<InstdRmbrsmntAgt>
Financial Institution Identification	<FinInstnId>
BICFIIdentifier	<BICFI>DEUTDEFFXXX</BICFI>
End of Financial Institution Identification	</FinInstnId>
End of InstructedReimbursementAgent	</InstdRmbrsmntAgt>
IntermediaryAgent	<IntrmyAgt>
Financial Institution Identification	<FinInstnId>
BICFIIdentifier	<BICFI>DRESDEFFXXX</BICFI>
End of Financial Institution Identification	</FinInstnId>
End of IntermediaryAgent	</IntrmyAgt>
Creditor Agent	<CdtrAgt>
Financial Institution Identification	<FinInstnId>
BICFIIdentifier	<BICFI>DEUTDEFFXXX</BICFI>
End of Financial Institution Identification	</FinInstnId>
End of Creditor Agent	</CdtrAgt>
Creditor	<Cdtr>
Financial Institution Identification	<FinInstnId>
BICFIIdentifier	<BICFI>DEUTDEFFXXX</BICFI>
End of Financial Institution Identification	</FinInstnId>
End of Creditor	</Cdtr>
End of Parties	</PmtTxPty>
End of PaymentSearch	</PmtSch>
End of SearchCriteria	</SchCrit>
ReturnCriteria	<RtrCrit>
PaymentReturnCriteria	<PmtRtrCrit>
MessageIdIndicator	<MsgIdInd>true</MsgIdInd>
InstructionStatusReturnCriteria	<InstrStsRtrCrit>
PaymentInstructionStatusIndicator	<PmtInstrStsInd>true</PmtInstrStsInd>
End InstructionStatusReturnCriteria	</InstrStsRtrCrit>
InterBankSettlementAmountIndicator	<IntrBkSttlmAmtInd>true</IntrBkSttlmAmtInd>
Credit Debit Indicator	<CdtDbtInd>true</CdtDbtInd>
PriorityIndicator	<PrtyInd>true</PrtyInd>
PaymentTypeIndicator	<PmtTpInd>true</PmtTpInd>
TransactionIdIndicator	<TxldInd>true</TxldInd>
InterBankSettlementDateIndicator	<IntrBkSttlmDtInd>true</IntrBkSttlmDtInd>
EndToEndIdIndicator	<EndToEndIdInd>true</EndToEndIdInd>
PaymentMethod Indicator	<PmtMtdInd>true</PmtMtdInd>
DebtorAgentIndicator	<DbtrAgtInd>true</DbtrAgtInd>
InstructedReimbursementAgentIndicator	<InstdRmbrsmntAgtInd>true</InstdRmbrsmntAgtInd>
IntermediaryIndication	<IntrmyInd>true</IntrmyInd>
CreditorAgentIndicator	<CdtrAgtInd>true</CdtrAgtInd>
CreditorIndicator	<CdtrInd>true</CdtrInd>
End PaymentReturnCriteria	</PmtRtrCrit>
End of ReturnCriteria	</RtrCrit>

End of NewCriteria				</NewCrit>
End of Transaction query criteria.				</TxCrit>
End of Transaction query definition				</TxQryDef>
End of Messagename for GetTransaction				</GetTx>

GetTransaction_PM_5

Scope: Get Transaction: request for a specific ErrorCode including complete copy of SWIFT-FIN message

Message name for GetTransaction	<GetTx>
Message Header	<MsgHdr>
Message Identification	<MsgId>ABC123</MsgId>
End of Message Header	</MsgHdr>
Transaction query definition	<TxQryDef>
Transaction query criteria.	<TxCrit>
NewCriteria	<NewCrit>
SearchCriteria	<SchCrit>
PaymentSearch	<PmtSch>
PaymentStatus	<Sts>
PaymentStatusCode	<PmtInstrSts>
FinalStatus	<FnlSts>RJTD</FnlSts>
End PaymentStatusCode	</PmtInstrSts>
ProprietaryStatusReasonCode	<PrtryStsRsn>F08</PrtryStsRsn>
End of PaymentStatus	</Sts>
End of PaymentSearch	</PmtSch>
End of SearchCriteria	</SchCrit>
ReturnCriteria	<RtrCrit>
PaymentToReturnCriteria	<PmtToRtrCrit>
MemberIdentificationIndicator	<MmbldInd>>true</MmbldInd>
End PaymentToReturnCriteria	</PmtToRtrCrit>
PaymentFromReturnCriteria	<PmtFrRtrCrit>
MemberIdentificationIndicator	<MmbldInd>>true</MmbldInd>
End PaymentFromReturnCriteria	</PmtFrRtrCrit>
PaymentReturnCriteria	<PmtRtrCrit>
MessageIdIndicator	<MsgIdInd>>true</MsgIdInd>
InstructionStatusReturnCriteria	<InstrStsRtrCrit>
PaymentInstructionStatusIndicator	<PmtInstrStsInd>true</PmtInstrStsInd>
End InstructionStatusReturnCriteria	</InstrStsRtrCrit>
InterBankSettlementAmountIndicator	<IntrBkSttlmAmtInd>true</IntrBkSttlmAmtInd>
Credit Debit Indicator	<CdtDbtInd>true</CdtDbtInd>
PriorityIndicator	<PrtyInd>true</PrtyInd>
ProcessingValidityTimeIndicator	<PrcgVldtyTmInd>true</PrcgVldtyTmInd>
InstructionCopyIndicator	<InstrCpyInd>true</InstrCpyInd>
InterBankSettlementDateIndicator	<IntrBkSttlmDtInd>true</IntrBkSttlmDtInd>
PaymentMethod Indicator	<PmtMtdInd>true</PmtMtdInd>
End PaymentReturnCriteria	</PmtRtrCrit>
End of ReturnCriteria	</RtrCrit>
End of NewCriteria	</NewCrit>
End of Transaction query criteria.	</TxCrit>
End of Transaction query definition	</TxQryDef>
End of Message name for GetTransaction	</GetTx>

6. 4.14 LiquidityCreditTransfer

Cash Management Standard

LiquidityCreditTransfer_PM

Scope: The LiquidityCreditTransfer message is used to transfer funds between

- two accounts belonging to the same participant from
 - RTGS account to HAM account.
 - RTGS account to PHA account (if CB supports the interface).
 - RTGS account to sub-account
 - sub-account to RTGS account.
- two accounts belonging to a group of accounts ("virtual account" or "consolidated information").

In these two cases, the transfer of funds is recognized as Liquidity Transfer.

- two accounts belonging to different participants from RTGS to other HAM accounts (i.e. debtor is not the account owner of the credit account). This transfer is recognized as Interbank Transfer.

The LiquidityCreditTransfer message can be sent by the application of the

- direct PM participant for own account.
- group of accounts manager in case of two accounts belonging to his group of accounts.
- CB on behalf of a participant it is responsible for.

The LiquidityCreditTransfer message is replied by a Receipt message.
Non-Repudiation of Emission (NRE) is mandatory.

<camt.050.001.xx>

Structure:

Message name for LiquidityCreditTransfer	<LqdyCdtTrf>
Message Header	<MsgHdr>
Message Identification	<MsgId></MsgId>
End of Message Header	</MsgHdr>
LiquidityCreditTransfer1	<LqdyCdtTrf>
Choice	xorCdtrCdtrAcct
Creditor	<Cdtr>
Financial Institution Identification	<FinInstnId>
BICFIIdentifier	<BICFI></BICFI>
End of Financial Institution Identification	</FinInstnId>
End of Creditor	</Cdtr>
CreditorAccount	<CdtrAcct>
Identification	<Id>
GenericAccountIdentification	<Othr>
Identification	<Id></Id>
End of GenericAccountIdentification	</Othr>
End Identification	</Id>
CashAccountType	<Tp>
ExternalCashAccountTypeCode	<Cd></Cd>
End of CashAccountType	</Tp>
EndCreditorAccount	</CdtrAcct>
Transferred Amount	<TrfdAmt>
Amount without currency	<AmtWthtCcy></AmtWthtCcy>
End of Transferred Amount	</TrfdAmt>
DebtorAccount	<DbtrAcct>
Identification	<Id>
GenericAccountIdentification	<Othr>
Identification	<Id></Id>
End of GenericAccountIdentification	</Othr>
End Identification	</Id>
CashAccountType	<Tp>
ExternalCashAccountTypeCode	<Cd></Cd>

End of CashAccountType				</Tp>
EndDebtorAccount				</DbtrAcct>
End of Choice				/xorCdtrCdtrAcct
End of LiquidityCreditTransfer1				</LqdyCdtTrf>
End message name LiquidityCreditTransfer				</LqdyCdtTrf>

Attributes:

name of attribute	format	short description	description
<LqdyCdtTrf>		Message name for LiquidityCreditTransfer Mandatory A2A	Message name for LiquidityCreditTransfer Validation: [1..1]
<MsgHdr>		Message Header Mandatory A2A	Set of characteristics specific to the message Validation: [1..1]
<MsgId>-</MsgId>	16x	Message Identification Mandatory A2A	String of characters that uniquely identifies a message Validation: [1..1]
</MsgHdr>		End of Message Header Mandatory A2A	Validation: [1..1]
<LqdyCdtTrf>		LiquidityCreditTransfer1 Mandatory	LiquidityCreditTransfer Validation: [1..1]
xorCdtrCdrAcct		Choice Optional	Choice amongst <Cdr> and <CdrAcct> Validation:
<Cdr>		Creditor Optional A2A	account owner of the HAM account to be credited This element is used for initiation of Interbank Transfers to another participant's HAM account. Validation: [0..1] CreditAccountOwner must not be the debtor of the payment and must not be a CB customer account.
<FinInstnId>		Financial Institution Identification Mandatory	Financial Institution Identification Validation: [1..1]
<BICFI>-</BICFI>	4!a2!a2!c3!c	BICFIIdentifier Mandatory A2A	BICFIIdentifier Validation: [1..1]
</FinInstnId>		End of Financial Institution Identification Mandatory	End of Financial Institution Identification Validation: [1..1]
</Cdr>		End of Creditor Optional	Validation: [0..1]
<CdrAcct>		CreditorAccount	Account credited as a result of a credit entry. This element may only be used in case of Liquidity Transfer orders: - Liquidity transfer RTGS to HAM - Liquidity transfer RTGS to mirror account

name of attribute	format	short description	description
		Optional A2A	- Liquidity transfer RTGS to PHA - Liquidity transfer RTGS to RTGS (only for GoA) - Liquidity transfer RTGS to sub-account - Liquidity transfer sub-account to RTGS Validation: [0..1] In case of LT to home accounts the account owner of credit account has to be equal to debit account owner. Furthermore, a liquidity removal address (daylight!) has to be present in active SD record of RTGS account to be debited.
<Id>		Identification Mandatory A2A	Identification Validation: [1..1]
<Othr>		GenericAccountIdentification Mandatory A2A	GenericAccountIdentification Validation: [1..1]
<Id>-</Id>	34x	Identification Mandatory A2A	Name or number assigned by an entity to enable recognition of that entity, eg, account identifier. Validation: [1..1] credited account - account number of the home accounting module, proprietary home accounting, subaccount or on behalf of a third party, the main account, when not stated the main account of the participant is used
</Othr>		End of GenericAccountIdentification Mandatory A2A	End of GenericAccountIdentification Validation: [1..1]
</Id>		End Identification Mandatory A2A	End Identification Validation: [1..1]
<Tp>		CashAccountType Mandatory A2A	CashAccountType Validation: [1..1]
<Cd>-</Cd>		ExternalCashAccountType Code Mandatory A2A	ExternalCashAccountTypeCode SSP restricted code list: CACC = Current Account used to post debits and credits when no specific account has been nominated SACC = Settlement Account used to post debit and credit entries, as a result of transactions cleared and settled through a specific clearing and settlement system. Type of the account to be credited CACC = account in HAM or PHA or SACC (RTGS account). Validation: [1..1] in PM only SACC = PM and CACC = HomeAccount are used

name of attribute	format	short description	description
</Tp>		End of CashAccountType	End of CashAccountType
		Mandatory	Validation: [1..1]
</CdtrAcct>		EndCreditorAccount	
		Optional	Validation: [0..1]
		A2A	
<TrfdAmt>		Transferred Amount	The amount may be defined with or without the currency. <AmtWthCcy> CurrencyAndAmount <AmtWthCcy> ImpliedCurrencyAndAmount
		Mandatory	Validation: [1..1] in PM only <AmtWthCcy> is used. field must be followed by <FrToAcct>
		A2A	
<AmtWthCcy>- </AmtWthCcy>	18n	Amount without currency	Number of monetary units specified in a currency where the unit of currency is implied by the context. totalDigits = 18 fractionDigits = 5 represents F32_AMOUNT
		Mandatory	Validation: [1..1] in PM only 2 fraction digits are possible value restriction: maximum value 999.999.999.999,99 0,00 value is not allowed
		A2A	
</TrfdAmt>		End of Transferred Amount	
		Mandatory	Validation: [1..1]
		A2A	
<DbtrAcct>		DebtorAccount	Account to or from which a cash entry is made
		Optional	Validation: [0..1]
		A2A	
<Id>		Identification	Identification
		Mandatory	Validation: [1..1]
		A2A	
<Othr>		GenericAccountIdentificatio n	GenericAccountIdentification
		Mandatory	Validation: [1..1]
		A2A	
<Id>-</Id>	34x	Identification	Name or number assigned by an entity to enable recognition of that entity, eg, account identifier.
		Mandatory	Validation: [1..1] debited account - account number of the sub- account or on behalf of a third party, the main account, when not stated the main account of the participant is used
		A2A	
</Othr>		End of GenericAccountIdentificatio n	End of GenericAccountIdentification
		Mandatory	Validation: [1..1]
		A2A	
</Id>		End Identification	End Identification

name of attribute	format	short description	description
		Mandatory	Validation:
		A2A	[1..1]
<Tp>		CashAccountType	CashAccountType
		Optional	Validation:
<Cd>-</Cd>		ExternalCashAccountType Code	ExternalCashAccountTypeCode SSP restricted code list: CACC = Current Account used to post debits and credits when no specific account has been nominated SACC = Settlement Account used to post debit and credit entries, as a result of transactions cleared and settled through a specific clearing and settlement system. Type of the account to be debited CACC = account in HAM or PHA or SACC (RTGS account).
		Mandatory	Validation:
		A2A	[1..1] in PM only SACC = PM and CACC = HomeAccount are used
</Tp>		End of CashAccountType	End of CashAccountType
		Optional	Validation:
</DbtrAcct>		EndDebtorAccount	
		Optional	Validation:
		A2A	[0..1]
/xorCdtCdtrAcct		End of Choice	
		Optional	Validation:
</LqdyCdtTrf>		End of LiquidityCreditTransfer1	End of LiquidityCreditTransfer
		Mandatory	Validation:
			[1..1]
</LqdyCdtTrf>		End message name LiquidityCreditTransfer	End message name LiquidityCreditTransfer
		Mandatory	Validation:
		A2A	[1..1]

Error Codes:

Order	Error code				Error Text / Validation/ Remark
	SSP	Y-copy	V-shape	XML	
1	X00			0000	<p>Error Text: O.k.</p> <p>Validation: Confirmation, that a task is stored in the task queue. A related reference for the subsequent processing (e.g. confirmation) of the task is returned.</p> <p>Remark: Receipt (status code)</p>
2	X44			1404	<p>Error Text: If "non repudiation of emission" is mandatory, the NRE indicator flag has to be present</p> <p>Validation: If non-repudiaton processing is mandatory, the tag <SwInt:NRIndicator>TRUE</SwInt:NRIndicator> has to be present.</p> <p>Remark: checked by ICM / Receipt</p>
3	X41			1401	<p>Error Text: No permission. RBAC User role(s) are not sufficient.</p> <p>Validation: RBAC role name "APPLICATE", "APPLICSTE" or "APPLICBTE" are required.</p> <p>Remark: checked by ICM / Receipt</p>
4	X53			1412	<p>Error Text: Credit account does not belong to the debtor</p> <p>Validation: CdtAcct/Id/DmstAcct/Id (profile credit institution) value must indicate either a HAM account, PHA account or sub-account that belongs to debtor</p> <p>Remark: checked by ICM / Receipt</p>
5	X42			1402	<p>Error Text: No authorisation. User is not allowed acting on behalf of another participant.</p> <p>Validation: DbtAcct/Id/DmstAcct/Id (profile credit institution) value must indicate a sub-account that belongs to the CI itself or to a participant the CI is entitled to act on behalf of</p> <p>Remark: checked by ICM / Receipt</p>
6	X45			1405	<p>Error Text: No authorisation or rather interaction not possible. User is not allowed acting on behalf of another participant as Group of Account manager</p> <p>Validation: CdtAcct/Id/DmstAcct/Id (profile group of accounts manager) value must indicate an account that belongs to a member of the group of accounts the participant is the manager of</p> <p>Remark: checked by ICM / Receipt</p>
7	X45			1405	<p>Error Text: No authorisation or rather interaction not possible. User is not allowed acting on behalf of another participant as Group of Account manager</p> <p>Validation: DbtAcct/Id/DmstAcct/Id (profile group of accounts manager) value must indicate an account that belongs to a member of the group of accounts the participant is the manager of</p> <p>Remark: checked by ICM / Receipt</p>
8	X47			1407	<p>Error Text: No authorisation. User is not allowed acting on behalf of another Participant as Central Bank</p> <p>Validation: DbtAcct/Id/DmstAcct/Id (profile central bank) value must indicate either a sub-account or a main-account that belongs to the CB itself or to a participant the CB is responsible for</p> <p>Remark: checked by ICM / Receipt</p>
9	X47			1407	<p>Error Text: No authorisation. User is not allowed acting on behalf of another Participant as Central Bank</p> <p>Validation: CdtAcct/Id/DmstAcct/Id (profile central bank) value must indicate either a HAM account, PHA account, sub-account or main-account that belongs to the CI itself or to a participant the CI is entitled to act on behalf of</p> <p>Remark: checked by ICM / Receipt</p>

Order	Error code				Error Text / Validation/ Remark
	SSP	Y-copy	V-shape	XML	
10	P59			P059	Error Text: Either credit account or debited account must be present Validation: Rule: either credit account or debited account must be present when CdtAcct/Id/DmstAcct/Id is not present then DbtAcct/Id/DmstAcct/Id must be stated and vice versa Remark: checked by ICM / Receipt
11	P56			P056	Error Text: Invalid credited account Validation: credited account must indicate an account of an SSP participant (TARGET2 Directory) Remark: checked by ICM / Receipt
12	P57			P057	Error Text: Invalid debited account Validation: debited account must indicate an account of an SSP participant (TARGET2 Directory) Remark: checked by ICM / Receipt
13	X52			1410	Error Text: Debit and credit account do not belong to the same Group of Accounts. Validation: Debit and credit account have to belong to the same virtual account Remark: checked by ICM / Receipt
14	894	K4		2894	Error Text: Function is not allowed in the current business day phase Validation: SSP is open Remark: checked by PM / TaskQueue
15	862	C2	TM01	2862	Error Text: Request out of cut-off time Validation: Request before cut-off time Remark: checked by PM / TaskQueue
16	866	C6	AC06	2866	Error Text: Exclusion of participant Validation: If requestor is direct participant or ancillary system or GoA manager and this requestor is excluded, no change of data is allowed Remark: checked by PM / TaskQueue
17	862	C2	TM01	2862	Error Text: Request out of cut-off time Validation: Possibility to use this function during the current phase of business day. Remark: checked by PM / TaskQueue
18	P65			P065	Error Text: Sub-account not known in PM or not connected with AS Validation: AS of the affected sub-account is not available (validation for LiquidityCreditTransfer from or to sub-accounts) Remark: TaskQueue
19	P65			P065	Error Text: Sub-account not known in PM or not connected with AS Validation: sub-account (credited or debited) has to be valid Remark: checked by / PMTaskQueue
20	P66			P066	Error Text: The order was rejected because it was received after an end of procedure message (out of the procedure time frame). Validation: In case of transfers from/to Sub Accounts: If the order was received after an end of procedure message (out of the procedure time frame), the order will be rejected. Remark: TaskQueue / checked by PM

Order	Error code				Error Text / Validation/ Remark
	SSP	Y-copy	V-shape	XML	
21	P67	L6		P067	Error Text: Liquidity on the debited account is not sufficient Validation: Liquidity control Remark: TaskQueue / checked by PM
22	P68	L7		P068	Error Text: There is a highly urgent payment in the queue Validation: FIFO principle Remark: TaskQueue / checked by PM
23	P36			P236	Error Text: Procedure already closed Validation: if sub-account of an AS is affected, the procedure has to be open Remark: TaskQueue
24	P54			P054	Error Text: Sub-account does not belong to the RTGS account Validation: Liquidity-Transfer from main account to own sub account: sub-account belongs to the debtor Remark: TaskQueue
25	P54			P054	Error Text: Sub-account does not belong to the RTGS account Validation: Liquidity-Transfer from own sub account to main account : sub-account belongs to the creditor Remark: TaskQueue
26	P42			P212	Error Text: Reference limited to 16 alphanumerical characters Validation: If the sub-account of an AS is affected, the length of message identification is limited to 16x Remark:
27	853	B3	XI13	2853	Error Text: Unexpected data Validation: If the sub-account of an AS is affected, the Type of the AccountType must be "SACC" Remark:
28	705			2705	Error Text: The address for liquidity removal is missing Validation: The address for liquidity removal must be available Remark: TaskQueue
29	A55			A055	Error Text: Requested time for end of settlement period is not possible in the past Validation: In case of transfers from/to Sub Accounts: If the order was received after an end of procedure message (out of the procedure time frame), the order will be rejected. Remark: TaskQueue
30	P56			P056	Error Text: Invalid credited account Validation: Element CreditAccountOwner <CdtAcctOwnr> must contain a valid BIC with a HAM account (Type "CACCC") Remark: checked by ICM / Receipt
31	P56			P056	Error Text: Invalid credited account Validation: Debtor of the payment must not be the CreditAccountOwner <CdtAcctOwnr> of account to be credited Remark: checked by ICM / Receipt
32	P56			P056	Error Text: Invalid credited account Validation: The account of the receiver BIC CreditAccountOwner <CdtAcctOwnr> must not be a CB customer account

Order	Error code				Error Text / Validation/ Remark
	SSP	Y-copy	V-shape	XML	
					Remark: checked by ICM / Receipt
33	X45			1405	<p>Error Text: No authorisation or rather interaction not possible. User is not allowed acting on behalf of another participant as Group of Account manager</p> <p>Validation: If the requestor's profile is "Group of Accounts manager" then element CreditAccountOwner <CdtAcctOwnr> may only be used if the debit account is his own.</p> <p>Remark: checked by ICM / Receipt</p>
35	P57			P057	<p>Error Text: Invalid debited account</p> <p>Validation: If element CreditAccountOwner <CdtAcctOwnr> is filled, DbtAcct/Id/DmstAcct/Id must not indicate a sub-account.</p> <p>Remark: checked by ICM / Receipt</p>

LiquidityCreditTransfer_PM_1

Scope: Liquidity Transfer from RTGS main account to sub-account. LiquidityTransfer send by the account owner

Message name for LiquidityCreditTransfer	<LqdyCdtTrf>
Message Header	<MsgHdr>
Message Identification	<MsgId>ABC123</MsgId>
End of Message Header	</MsgHdr>
LiquidityCreditTransfer1	<LqdyCdtTrf>
CreditorAccount	<CdtrAcct>
Identification	<Id>
GenericAccountIdentification	<Othr>
Identification	<Id>PM1234567890-00</Id>
End of GenericAccountIdentification	</Othr>
End Identification	</Id>
CashAccountType	<Tp>
ExternalCashAccountTypeCode	<Cd>SACC</Cd>
End of CashAccountType	</Tp>
EndCreditorAccount	</CdtrAcct>
Transferred Amount	<TrfdAmt>
Amount without currency	<AmtWthtCcy>123456.12</AmtWthtCcy>
End of Transferred Amount	</TrfdAmt>
End of LiquidityCreditTransfer1	</LqdyCdtTrf>
End message name LiquidityCreditTransfer	</LqdyCdtTrf>

LiquidityCreditTransfer_PM_2

Scope: Liquidity Transfer from sub-account to RTGS main account. LiquidityTransfer send by the account owner

Message name for LiquidityCreditTransfer	<LqdyCdtTrf>
Message Header	<MsgHdr>
Message Identification	<MsgId>ABC123</MsgId>
End of Message Header	</MsgHdr>
LiquidityCreditTransfer1	<LqdyCdtTrf>
Transferred Amount	<TrfdAmt>
Amount without currency	<AmtWthtCcy>123456.12</AmtWthtCcy>
End of Transferred Amount	</TrfdAmt>
DebtorAccount	<DbtrAcct>
Identification	<Id>
GenericAccountIdentification	<Othr>
Identification	<Id>PM1234567890-00</Id>
End of GenericAccountIdentification	</Othr>
End Identification	</Id>
CashAccountType	<Tp>
ExternalCashAccountTypeCode	<Cd>SACC</Cd>
End of CashAccountType	</Tp>
EndDebtorAccount	</DbtrAcct>
End of LiquidityCreditTransfer1	</LqdyCdtTrf>
End message name LiquidityCreditTransfer	</LqdyCdtTrf>

LiquidityCreditTransfer_PM_3

Scope: Liquidity Transfer from RTGS main account to home account. LiquidityTransfer send by the account owner

Message name for LiquidityCreditTransfer	<LqdyCdtTrf>
Message Header	<MsgHdr>
Message Identification	<MsgId>ABC123</MsgId>
End of Message Header	</MsgId>
LiquidityCreditTransfer1	<LqdyCdtTrf>
CreditorAccount	<CdtrAcct>
Identification	<Id>
GenericAccountIdentification	<Othr>
Identification	<Id>HAM1234567890</Id>
End of GenericAccountIdentification	</Othr>
End Identification	</Id>
CashAccountType	<Tp>
ExternalCashAccountTypeCode	<Cd>CACC</Cd>
End of CashAccountType	</Tp>
EndCreditorAccount	</CdtrAcct>
Transferred Amount	<TrfdAmt>
Amount without currency	<AmtWthtCcy>123456.12</AmtWthtCcy>
End of Transferred Amount	</TrfdAmt>
End of LiquidityCreditTransfer1	</LqdyCdtTrf>
End message name LiquidityCreditTransfer	</LqdyCdtTrf>

LiquidityCreditTransfer_PM_4

Scope: Liquidity Transfer from RTGS main account to sub-account. LiquidityTransfer send by third party: Sender of the message is not the Account Owner.

Message name for LiquidityCreditTransfer	<LqdyCdtTrf>
Message Header	<MsgHdr>
Message Identification	<MsgId>ABC123</MsgId>
End of Message Header	</MsgHdr>
LiquidityCreditTransfer1	<LqdyCdtTrf>
CreditorAccount	<CdtrAcct>
Identification	<Id>
GenericAccountIdentification	<Othr>
Identification	<Id>PM1234567890-00</Id>
End of GenericAccountIdentification	</Othr>
End Identification	</Id>
CashAccountType	<Tp>
ExternalCashAccountTypeCode	<Cd>SACC</Cd>
End of CashAccountType	</Tp>
EndCreditorAccount	</CdtrAcct>
Transferred Amount	<TrfdAmt>
Amount without currency	<AmtWthtCcy>123456.12</AmtWthtCcy>
End of Transferred Amount	</TrfdAmt>
DebtorAccount	<DbtrAcct>
Identification	<Id>
GenericAccountIdentification	<Othr>
Identification	<Id>PM1234567890</Id>
End of GenericAccountIdentification	</Othr>
End Identification	</Id>
CashAccountType	<Tp>
ExternalCashAccountTypeCode	<Cd>SACC</Cd>
End of CashAccountType	</Tp>
EndDebtorAccount	</DbtrAcct>
End of LiquidityCreditTransfer1	</LqdyCdtTrf>
End message name LiquidityCreditTransfer	</LqdyCdtTrf>

LiquidityCreditTransfer_PM_5

Scope: Liquidity Transfer from sub-account to RTGS main account. LiquidityTransfer send by third party: Sender of the message and Account Owner are different.

Message name for LiquidityCreditTransfer	<LqdyCdtTrf>
Message Header	<MsgHdr>
Message Identification	<MsgId>ABC12345</MsgId>
End of Message Header	</MsgHdr>
LiquidityCreditTransfer1	<LqdyCdtTrf>
CreditorAccount	<CdtrAcct>
Identification	<Id>
GenericAccountIdentification	<Othr>
Identification	<Id>PM1234567890</Id>
End of GenericAccountIdentification	</Othr>
End Identification	</Id>
CashAccountType	<Tp>
ExternalCashAccountTypeCode	<Cd>SACC</Cd>
End of CashAccountType	</Tp>
EndCreditorAccount	</CdtrAcct>
Transferred Amount	<TrfdAmt>
Amount without currency	<AmtWthtCcy>123456.12</AmtWthtCcy>
End of Transferred Amount	</TrfdAmt>
DebtorAccount	<DbtrAcct>
Identification	<Id>
GenericAccountIdentification	<Othr>
Identification	<Id>PM1234567890-00</Id>
End of GenericAccountIdentification	</Othr>
End Identification	</Id>
CashAccountType	<Tp>
ExternalCashAccountTypeCode	<Cd>SACC</Cd>
End of CashAccountType	</Tp>
EndDebtorAccount	</DbtrAcct>
End of LiquidityCreditTransfer1	</LqdyCdtTrf>
End message name LiquidityCreditTransfer	</LqdyCdtTrf>

LiquidityCreditTransfer_PM_6

Scope: Liquidity Transfer from RTGS main account to home-account. LiquidityTransfer send by third party: Sender of the message is not the Account Owner.

Message name for LiquidityCreditTransfer	<LqdyCdtTrf>
Message Header	<MsgHdr>
Message Identification	<MsgId>ABC1234</MsgId>
End of Message Header	</MsgHdr>
LiquidityCreditTransfer1	<LqdyCdtTrf>
CreditorAccount	<CdtrAcct>
Identification	<Id>
GenericAccountIdentification	<Othr>
Identification	<Id>HAM1234567890</Id>
End of GenericAccountIdentification	</Othr>
End Identification	</Id>
CashAccountType	<Tp>
ExternalCashAccountTypeCode	<Cd>CACC</Cd>
End of CashAccountType	</Tp>
EndCreditorAccount	</CdtrAcct>
Transferred Amount	<TrfdAmt>
Amount without currency	<AmtWthtCcy>123456.12</AmtWthtCcy>
End of Transferred Amount	</TrfdAmt>
DebtorAccount	<DbtrAcct>
Identification	<Id>
GenericAccountIdentification	<Othr>
Identification	<Id>PM1234567890</Id>
End of GenericAccountIdentification	</Othr>
End Identification	</Id>
CashAccountType	<Tp>
ExternalCashAccountTypeCode	<Cd>SACC</Cd>
End of CashAccountType	</Tp>
EndDebtorAccount	</DbtrAcct>
End of LiquidityCreditTransfer1	</LqdyCdtTrf>
End message name LiquidityCreditTransfer	</LqdyCdtTrf>

LiquidityCreditTransfer_PM_7

Scope: Interbank transfer from RTGS main account to another participant's home account. LiquidityCreditTransfer message sent by a third party; Sender of the message is not the Account Owner.

Message name for LiquidityCreditTransfer	<LqdyCdtTrf>
Message Header	<MsgHdr>
Message Identification	<MsgId>ABCdef7890</MsgId>
End of Message Header	</MsgHdr>
LiquidityCreditTransfer1	<LqdyCdtTrf>
Creditor	<Cdtr>
Financial Institution Identification	<FinInstnId>
BICFIIdentifier	<BICFI>BBBBITRRXX</BICFI>
End of Financial Institution Identification	</FinInstnId>
End of Creditor	</Cdtr>
Transferred Amount	<TrfdAmt>
Amount without currency	<AmtWthtCcy>6547879.01</AmtWthtCcy>
End of Transferred Amount	</TrfdAmt>
DebtorAccount	<DbtrAcct>
Identification	<Id>
GenericAccountIdentification	<Othr>
Identification	<Id>BE67123456789122345620</Id>
End of GenericAccountIdentification	</Othr>
End Identification	</Id>
CashAccountType	<Tp>
ExternalCashAccountTypeCode	<Cd>SACC</Cd>
End of CashAccountType	</Tp>
EndDebtorAccount	</DbtrAcct>
End of LiquidityCreditTransfer1	</LqdyCdtTrf>
End message name LiquidityCreditTransfer	</LqdyCdtTrf>

6. 4.15 ModifyCreditLine

SSP Proprietary Messages

ModifyCreditLine_PM

Scope: The ModifyCreditLine message is used to define or modify the credit line available at the RTGS account.

The ModifyCreditLine can be sent by the application of the home central bank (CB) of the account holding direct PM participant.

Additional to the possibility to define new fixed CreditLine amounts, delta amount ModifyCreditLine instructions can be sent.

The ModifyCreditLine message is replied by a Receipt message.

Non-Repudiation of Emission (NRE) is mandatory.

<camt.998.001.xx>

Structure:

Name Proprietary message	<PrtryMsg>
Message Header	<MsgHdr>
Message Identification	<MsgId--</MsgId>
End of Message Header	</MsgHdr>
Proprietary Data	<PrtryData>
Proprietary Data type	<Tp>ModifyCreditLine</Tp>
Proprietary Data	<Data>
SSP Proprietary Data	<SspPrtryDt>
Credit Line Identification	<CrdtLnId>
Account Owner	<AcctOwnr></AcctOwnr>
End Credit Line Id	</CrdtLnId>
New credit line details	<NewCrdtLnValSet>
Amount without currency	<AmtWthtCcy></AmtWthtCcy>
OrderTypeCode	<OrdTpCd></OrdTpCd>
End New credit line details	</NewCrdtLnValSet>
End of SSP Proprietary Data	</SspPrtryDt>
End of Proprietary Data	</Data>
End of Proprietary Data	</PrtryData>
End proprietary message	</PrtryMsg>

Attributes:

name of attribute	format	short description	description
<PrtryMsg>		Name Proprietary message Mandatory A2A	Validation:
<MsgHdr>		Message Header Mandatory A2A	Set of characteristics specific to the message Message Reference Validation: [1..1]
<MsgId>-</MsgId>	16x	Message Identification Mandatory A2A	String of characters that uniquely identifies a message Validation: [1..1]
</MsgHdr>		End of Message Header Mandatory A2A	Validation: [1..1]
<PrtryData>		Proprietary Data Mandatory A2A	Proprietary Data Validation: [1..1]
<Tp>-</Tp>		Proprietary Data type Mandatory A2A	Proprietary Data type here only ModifyCreditLine is possible Validation: [1..1]
<Data>		Proprietary Data Mandatory A2A	Proprietary data content Validation: [1..1]
<SspPrtryDt>		SSP Proprietary Data Mandatory A2A	Root element for all SSP proprietary data Validation: [1..1]
<CrdtLnId>		Credit Line Identification Mandatory A2A	Credit Line Identification free format tag Validation: [1..1]
<AcctOwnr>-</AcctOwnr>	11x	Account Owner Mandatory A2A	BICIdentifier e.g. needed on behalf of third parties if e. g. the NCB are able to start several transactions on behalf their national banking community. BIC of the RTGS account which will be modified Validation: [1..1] The requesting CB has to be responsible for the account owner.
</CrdtLnId>		End Credit Line Id Mandatory A2A	End Credit Line Id free format tag Validation: [1..1]

name of attribute	format	short description	description
<NewCrdtLnValSet>		New credit line details	New credit line details New credit line values.
		Mandatory	Validation:
		A2A	[1..1]
<AmtWthtCcy>- </AmtWthtCcy>	18n	Amount without currency	Number of monetary units specified in a currency where the unit of currency is implied by the context. The integer part of Amount must contain at least one digit. The decimal separator is a dot '.'. It is not mandatory but included in the maximum length. The number of digits following the dot must not exceed the maximum number allowed for that specific currency as specified in ISO 4217. New credit Line (EUR)
		Mandatory	Validation:
		A2A	[1..1] in PM there are 2 fraction digits possible value restriction: maximum value 999.999.999.999,99
<OrdrTpCd>-</OrdrTpCd>	4x	OrderTypeCode	The optional Tag OrderTypeCode marks the ModifyCreditLine message as a delta modification (delta amount MCL instruction) or as a fixed amount MCL instruction. Possible Values: INCR (increase) DECR (decrease) RPLC (replace) default (if element is not used): RPLC
		Optional	Validation:
		A2A	[0..1]
</NewCrdtLnValSet>		End New credit line details	End New credit line details New credit line values.
		Mandatory	Validation:
		A2A	[1..1]
</SspPrtryDt>		End of SSP Proprietary Data	End of Root element for all SSP proprietary data
		Mandatory	Validation:
		A2A	[1..1]
</Data>		End of Proprietary Data	
		Mandatory	Validation:
		A2A	[1..1]
</PrtryData>		End of Proprietary Data	End of Proprietary Data
		Mandatory	Validation:
		A2A	[1..1]
</PrtryMsg>		End proprietary message	
		Mandatory	Validation:
		A2A	

Error Codes:

Order	Error code				Error Text / Validation/ Remark
	SSP	Y-copy	V-shape	XML	
1	X00			0000	Error Text: O.k. Validation: Confirmation, that a task is stored in the task queue. A related reference for the subsequent processing (e.g. confirmation) of the task is returned. Remark: Receipt (status code)
2	X44			1404	Error Text: If "non repudiation of emission" is mandatory, the NRE indicator flag has to be present Validation: If non-repudiaton processing is mandatory, the tag <SwInt:NRIndicator>TRUE</SwInt:NRIndicator> has to be present. Remark: checked by ICM / Receipt
3	X41			1401	Error Text: No permission. RBAC User role(s) are not sufficient. Validation: message is allowed for central bank only. RBAC role name "APPLICBTE" or "APPLICSTE" is required Remark: checked by ICM / Receipt
4	X47			1407	Error Text: No authorisation. User is not allowed acting on behalf of another Participant as Central Bank Validation: AcctOwnr (profile Central Bank) value must indicate a participant the CB is responsible for Remark: checked by ICM / Receipt
5	X40			1400	Error Text: BIC must indicate a SSP participant Validation: BIC must indicate a SSP participant Remark: checked by ICM / Receipt
6	894	K4		2894	Error Text: Function is not allowed in the current business day phase Validation: SSP is open Remark: Task Queue
7	862	C2	TM01	2862	Error Text: Request out of cut-off time Validation: Possibility to use this function during the current phase of business day. Remark: checked by PM / TaskQueue
8	866	C6	AC06	2866	Error Text: Exclusion of participant Validation: If requestor is direct participant or ancillary system or GoA manager and this requestor is excluded, no change of data is allowed Remark: TaskQueue
9	703			2708	Error Text: Negative amounts are not allowed Validation: Amount must be positive Remark: TaskQueue
11	640	L4		NNCL	Error Text: Decrease must not lead to a negative credit line Validation: Decrease must not lead to a negative credit line. Remark: checked by PM / TaskQueue

ModifyCreditLine_PM_1

Scope: Modify CreditLine, NCB modify new credit line for RTGS account

Name Proprietary message	<PrtryMsg>
Message Header	<MsgHdr>
Message Identification	<MsgId>ABC123</MsgId>
End of Message Header	</MsgHdr>
Proprietary Data	<PrtryData>
Proprietary Data type	<Tp>ModifyCreditLine</Tp>
Proprietary Data	<Data>
SSP Proprietary Data	<SspPrtryDt>
Credit Line Identification	<CrdtLnId>
Account Owner	<AcctOwnr>DRESDEFFXXX</AcctOwnr>
End Credit Line Id	</CrdtLnId>
New credit line details	<NewCrdtLnValSet>
Amount without currency	<AmtWthtCcy>9000000.00</AmtWthtCcy>
End New credit line details	</NewCrdtLnValSet>
End of SSP Proprietary Data	</SspPrtryDt>
End of Proprietary Data	</Data>
End of Proprietary Data	</PrtryData>
End proprietary message	</PrtryMsg>

ModifyCreditLine_PM_2

Scope: Modify CreditLine, NCB increase credit line for RTGS account (delta based MCL-instruction)

Name Proprietary message	<PrtryMsg>
Message Header	<MsgHdr>
Message Identification	<MsgId>ABC123</MsgId>
End of Message Header	</MsgHdr>
Proprietary Data	<PrtryData>
Proprietary Data type	<Tp>ModifyCreditLine</Tp>
Proprietary Data	<Data>
SSP Proprietary Data	<SspPrtryDt>
Credit Line Identification	<CrdtLnId>
Account Owner	<AcctOwnr>DRESDEFFXXX</AcctOwnr>
End Credit Line Id	</CrdtLnId>
New credit line details	<NewCrdtLnValSet>
Amount without currency	<AmtWthtCcy>50000.00</AmtWthtCcy>
OrderTypeCode	<OrdTpCd>INCR</OrdTpCd>
End New credit line details	</NewCrdtLnValSet>
End of SSP Proprietary Data	</SspPrtryDt>
End of Proprietary Data	</Data>
End of Proprietary Data	</PrtryData>
End proprietary message	</PrtryMsg>

6. 4.16 ModifyLimit

Cash Management Standard

ModifyLimit _PM

Scope: The ModifyLimit message sent to PM is used to

- modify one or several current bilateral limits
- modify all current bilateral limits
- modify the current multilateral limit

The value 0,00 is possible for deletion of limits furthermore all bilateral limits can be deleted by sending a single request. When the last bilateral limit is deleted the multilateral limit is deleted automatically. (There will be no task for an automatic deletion!)

The ModifyLimit message can be sent by the application of a direct PM participant or the application of a group of accounts manager "virtual account" (definition and change of limits possible for the whole group only, not for the single account holder).

If a participant is a member of a group of accounts (VA) , the limit can only be defined against the whole group. Therefore limits that are defined against an account group have to be defined against the account owner (BIC) of the group of accounts manager.

The ModifyLimit message is replied by a Receipt message. The Receipt can contain multiple ReceiptDetails - one per affected limit. In case a remarkable number of limits shall be modified by sending only one request it may happen that a time-out message is returned. Then the customer application needs to send a GetPendingData request to get the Receipt with the list of task queue references.

To check the status of limit modifications a GetTask can be sent to PM. The ReturnTask provides one ModifyLimit message per task (for each modified limit) and its task status. It cannot be returned the original message the customer used.

Non-Repudiation of Emission (NRE) is supported.

<camt.011.001.xx>

Structure:

Message name for ModifyLimit	<ModfyLmt>
Message Header	<MsgHdr>
Message Identification	<MsgId></MsgId>
End of Message Header	</MsgHdr>
LimitDetails	<LmtDtls>
LimitIdentification	<LmtId>
Choice	xorCurAllCur
CurrentLimit	<Cur>
BilateralLimitCounterpartyId	<BilLmtCtrPtyId>
Financial Institution Identification	<FinInstnId>
BICFIIdentifier	<BICFI></BICFI>
End of Financial Institution Identification	</FinInstnId>
End of BilateralLimitCounterpartyId	</BilLmtCtrPtyId>
Limit Type	<Tp>
Limit Type Code	<Cd></Cd>
End of Limit Type	</Tp>
Account Owner	<AcctOwnr>
Financial Institution Identification	<FinInstnId>
BICFIIdentifier	<BICFI></BICFI>
End of Financial Institution Identification	</FinInstnId>
End of Account owner	</AcctOwnr>
End of CurrentLimit	</Cur>
AllCurrentLimits	<AllCur>
Limit Type	<Tp>
Limit Type Code	<Cd></Cd>
End of Limit Type	</Tp>
Account Owner	<AcctOwnr>
Financial Institution Identification	<FinInstnId>

BICFIIdentifier					<BICFI></BICFI>
End of Financial Institution Identification					</FinInstnId>
End of Account owner					</AcctOwnr>
End of AllCurrentLimits					</AllCur>
End choice					/xorCurAllCur
End of Limit Identification					</LmtId>
NewLimitValueSet					<NewLmtValSet>
Amount					<Amt>
Amount without currency					<AmtWthtCcy></AmtWthtCcy>
End of Amount					</Amt>
End of NewLimitValueSet					</NewLmtValSet>
End Limit details structure					</LmtDtls>
End of Messagename for ModifyLimit					</ModfyLmt>

Attributes:

name of attribute	format	short description	description
<ModifyLmt>		Message name for ModifyLimit Mandatory A2A	Message name for ModifyLimit Validation:
<MsgHdr>		Message Header Mandatory A2A	Set of characteristics specific to the message Validation: [1..1]
<MsgId>-</MsgId>	35x	Message Identification Mandatory A2A	Message Identification Validation: [1..1]
</MsgHdr>		End of Message Header Mandatory A2A	Validation: [1..1]
<LmtDtls>		LimitDetails Mandatory A2A	Identification of the details of one particular limit. Every occurrence is at least one separate task. The Receipt provides a reference to every task. Validation: [1..n]
<LmtId>		LimitIdentification Mandatory A2A	Validation: [1..1]
xorCurAllCur		Choice Mandatory	Choice amongst <Cur> and <AllCur> Validation:
<Cur>		CurrentLimit Mandatory	CurrentLimit Validation: [1..1]
<BilLmtCtrPtyId>		BilateralLimitCounterpartyId Optional A2A	Unique and unambiguous identification of a member within a system, assigned using the member identification scheme of the system. Validation: [0..1] Counterpart is filled in the case of an asked Bilateral Limit.
<FinInstnId>		Financial Institution Identification Mandatory	Financial Institution Identification Validation: [1..1]
<BICFI>-</BICFI>	4!a2!a2!c3!c	BICFIIdentifier Mandatory A2A	BICFIIdentifier Validation: [1..1]
</FinInstnId>		End of Financial Institution Identification Mandatory	End of Financial Institution Identification Validation: [1..1]

name of attribute	format	short description	description
</BilLmtCtrPtyId>		End of BilateralLimitCounterpartyId Optional A2A	End ofBilateralLimitCounterpartyIdentification Validation: [0..1]
<Tp>		Limit Type Mandatory A2A	Limit Type Validation: [1..1]
<Cd>-</Cd>		Limit Type Code	Limit Type Code SSP restricted code list: BILI = Bilateral Limit is applied by one party to a specific counterparty, and corresponds to the maximum amount of traffic party setting the limit can send to that counterparty. The limit can be expressed as a debit or a credit limit. With the help of a bilateral limit, the direct participant restricts the use of liquidity when clearing payments with another direct participant. MULT = Multilateral Limit is a maximum amount value applied to, or by, a participant to a set of counterparties. The multilateral limit is taken into account by the transaction administrator to contain the risk in the system. With the help of the multilateral limit, the direct participant restricts the use of liquidity when clearing payments with all other direct participants for which no bilateral limit is set for current Limit
		Optional	Validation: In SSP only BILI and MULT are allowed.
</Tp>		End of Limit Type Optional	End of Limit Type Validation:
<AcctOwnr>		Account Owner Optional A2A	Validation: [0..1]
<FinInstnId>		Financial Institution Identification Mandatory	Financial Institution Identification Validation: [1..1]
<BICFI>-</BICFI>	4!a2!a2!c3!c	BICFIIdentifier Mandatory	BICFIIdentifier BIC of the RTGS main account / in case of group of accounts BIC of GoA manager Validation: [1..1] In the case of "on behalf" scenario (sending party not Account Owner) mandatory. When not stated the BIC of the participant is used. Usage of AccountOwner is only allowed once per request.
</FinInstnId>		End of Financial Institution Identification Mandatory	End of Financial Institution Identification Validation: [1..1]
</AcctOwnr>		End of Account owner Optional	Validation:

name of attribute	format	short description	description
</Cur>		End of CurrentLimit	End of CurrentLimit
		Mandatory	Validation:
		A2A	[1..1]
<AllCur>		AllCurrentLimits	AllCurrentLimits
			If <Cd> is filled with BILI then for every bilateral counterpart a separate task is generated and a list of all task references is provided in the Receipt.
		Mandatory	Validation:
		A2A	[1..1]
<Tp>		Limit Type	Limit Type
		Mandatory	Validation:
		A2A	[1..1]
<Cd>-</Cd>		Limit Type Code	Limit Type Code
			SSP restricted code list:
			BILI = Bilateral Limit is applied by one party to a specific counterparty, and corresponds to the maximum amount of traffic party setting the limit can send to that counterparty. The limit can be expressed as a debit or a credit limit. With the help of a bilateral limit, the direct participant restricts the use of liquidity when clearing payments with another direct participant.
			MULT = Multilateral Limit is a maximum amount value applied to, or by, a participant to a set of counterparties. The multilateral limit is taken into account by the transaction administrator to contain the risk in the system. With the help of the multilateral limit, the direct participant restricts the use of liquidity when clearing payments with all other direct participants for which no bilateral limit is set
		Optional	Validation:
			In SSP only BILI and MULT are allowed.
</Tp>		End of Limit Type	End of Limit Type
		Optional	Validation:
<AcctOwnr>		Account Owner	
		Optional	Validation:
		A2A	[0..1]
<FinInstnId>		Financial Institution Identification	Financial Institution Identification
		Mandatory	Validation:
			[1..1]
<BICFI>-</BICFI>	4!a2!a2!c3!c	BICFIIdentifier	BICFIIdentifier
			BIC of the RTGS main account / in case of group of accounts BIC of GoA manager
		Mandatory	Validation:
			[1..1] In the case of "on behalf" scenario (sending party not Account Owner) mandatory. When not stated the BIC of the participant is used. Usage of AccountOwner is only allowed once per request.
</FinInstnId>		End of Financial Institution Identification	End of Financial Institution Identification

name of attribute	format	short description	description
		Mandatory	Validation: [1..1]
</AcctOwnr>		End of Account owner	
		Optional	Validation: [0..1]
</AllCur>		End of AllCurrentLimits	
		Mandatory	Validation: [1..1]
		A2A	
/xorCurAllCur		End choice	
		Mandatory	Validation:
</LmtId>		End of Limit Identification	
		Mandatory	Validation: [1..1]
<NewLmtValSet>		NewLimitValueSet	New limit values. Maximum value used for risk containment in a system or towards counterparts. The limit may be a current limit or a default limit.
		Mandatory	Validation: [1..1]
		A2A	
<Amt>		Amount	
		Mandatory	Validation: [1..1]
		A2A	
<AmtWthtCcy>- </AmtWthtCcy>	18n	Amount without currency	Number of monetary units specified in a currency where the unit of currency is implied by the context. totalDigits = 18 fractionDigits = 5 New current multilateral limit or new current bilateral limit. Value "0" can be used to delete the specified current limit(s). Validation: [1..1] In PM only 2 fraction digits are possible. Value restriction: maximum value 999.999.999.999,99. Limit value must be 1 million or more. The value 0,00 is possible for deletion of limits
		Mandatory	Validation: [1..1] In PM only 2 fraction digits are possible. Value restriction: maximum value 999.999.999.999,99. Limit value must be 1 million or more. The value 0,00 is possible for deletion of limits
		A2A	
</Amt>		End of Amount	End of Amount
		Mandatory	Validation: [1..1]
		A2A	
</NewLmtValSet>		End of NewLimitValueSet	End of NewLimitValueSet
		Mandatory	Validation: [1..1]
		A2A	
</LmtDtls>		End Limit details structure	
		Mandatory	Validation: [1..n]
		A2A	
</ModifyLmt>		End of Messagename for ModifyLimit	

name of attribute	format	short description	description
		Mandatory A2A	Validation:

Error Codes:

Order	Error code				Error Text / Validation/ Remark
	SSP	Y-copy	V-shape	XML	
1	X00			0000	Error Text: O.k. Validation: Confirmation, that a task is stored in the task queue. A related reference for the subsequent processing (e.g. confirmation) of the task is returned. Remark: Receipt (status code)
2	X44			1404	Error Text: If "non repudiation of emission" is mandatory, the NRE indicator flag has to be present Validation: If non-repudiaton processing is mandatory, the tag <SwInt:NRIndicator>TRUE</SwInt:NRIndicator> has to be present. Remark: checked by ICM / Receipt
3	X41			1401	Error Text: No permission. RBAC User role(s) are not sufficient. Validation: RBAC role name "APPLICATE" or "APPLICBTE" are required Remark: checked by ICM / Receipt
4	X45			1405	Error Text: No authorisation or rather interaction not possible. User is not allowed acting on behalf of another participant as Group of Account manager Validation: CurLmtld/AcctOwnr (profile group of accounts manager) value must indicate a member of the group of accounts the participant is the manager of Remark: checked by ICM / Receipt
5	X42			1402	Error Text: No authorisation. User is not allowed acting on behalf of another participant. Validation: CurLmtld/AcctOwnr (profile credit institution) value must indicate the credit institution itself or a participant who the credit institution is entitled to act on behalf of Remark: checked by ICM / Receipt
6	X47			1407	Error Text: No authorisation. User is not allowed acting on behalf of another Participant as Central Bank Validation: CurLmtld/AcctOwnr (profile central bank) value must indicate the central bank itself or a participant the central bank is responsible for Remark: checked by ICM / Receipt
7	X40			1400	Error Text: BIC must indicate a SSP participant Validation: BIC must indicate a SSP participant Remark: checked by ICM / Receipt
8	P12			P012	Error Text: Modification, setting or deletion of limits not possible Validation: BilLmtCtrPtyld/BIC value must not indicate the participant itself (self-addressed bilateral limit is not allowed) Remark: checked by ICM / Receipt
9	P51			P051	Error Text: BIC Bilateral Counterpart does not exist Validation: BilLmtCtrPtyld/BIC value must indicate a SSP participant Remark: checked by ICM / Receipt
10	X48			1408	Error Text: Interaction only possible for the virtual account manager Validation: change of limits for group of accounts is only possible by "Virtual account" manager Remark: checked by ICM / Receipt
11	894	K4		2894	Error Text: Function is not allowed in the current business day phase

Order	Error code				Error Text / Validation/ Remark
	SSP	Y-copy	V-shape	XML	
					Validation: SSP is open Remark: TaskQueue
12	862	C2	TM01	2862	Error Text: Request out of cut-off time Validation: Possibility to use this function during the current phase of business day. Remark: checked by PM / TaskQueue
13	866	C6	AC06	2866	Error Text: Exclusion of participant Validation: If requestor is direct participant or ancillary system or GoA manager and this requestor is excluded, no change of data is allowed Remark: TaskQueue
14	P12			P012	Error Text: Modification, setting or deletion of limits not possible Validation: bilateral limit against accounts without non-liability of cover is not allowed Remark: TaskQueue
15	P15			P015	Error Text: No bilateral limit defined for Counter Party Validation: it's not allowed to define a bilateral limit for the current day, if no bilateral limit exists Remark: TaskQueue
16	P14			P014	Error Text: No Limit found Validation: it's not allowed to define a multilateral limit for the current day, if no multilateral limit exists Remark: TaskQueue
17	P77			P107	Error Text: Limit value must be 1 million or more. The value 0,00 is possible for deletion of limits. Validation: New Current Bilateral Limit (EUR): minimum value is 1,000,000.00 EUR. The value 0,00 is possible for deletion of limits. Remark: TaskQueue
18	P77			P107	Error Text: Limit value must be 1 million or more. The value 0,00 is possible for deletion of limits. Validation: New Current Multilateral Limit (EUR)/New Current Bilateral Limit (EUR): minimum value is 1,000,000.00 EUR. The value 0,00 is possible for deletion of limits. Remark: TaskQueue
19	P30			P030	Error Text: Only one occurrence of the element <AcctOwnr> per message is allowed. Validation: If element <AcctOwnr> is used it may only occur once. Remark: checked by ICM / Receipt
20	P31			P031	Error Text: The modification or removal of a multilateral limit is allowed only once per message. Validation: The modification or removal of a multilateral limit may be requested only once per request. If type "MULT" occurs more than once an error message will be returned. Remark: checked by ICM / Receipt
21	P32			P032	Error Text: The same counterpart-BIC is only allowed not more than once per message. Validation: For the modification of several bilateral limits: The same counterpart-BIC is only allowed not more than once to have a unique reference within the Receipt message. Remark: checked by ICM / Receipt

Order	Error code				Error Text / Validation/ Remark
	SSP	Y-copy	V-shape	XML	
22	P33			P033	<p>Error Text: Invalid use of <AllCurLmts> or <AllDfltLmts>.</p> <p>Validation: If <AllCurLmts> is used in a request, <LmtDtIs> should occur at most twice. - Repetition only allowed if different limit types ("BILI" + "MULT") are filled in.</p> <p>Remark: checked by ICM / Receipt</p>
23	P33			P033	<p>Error Text: Invalid use of <AllCurLmts> or <AllDfltLmts>.</p> <p>Validation: It is not allowed to set a new value unequal to zero for multilateral limit if the modification of all bilateral limits to zero is requested in the same message.</p> <p>Remark: checked by ICM / Receipt</p>
24	P33			P033	<p>Error Text: Invalid use of <AllCurLmts> or <AllDfltLmts>.</p> <p>Validation: Modification of single limits in combination with 'All' is forbidden. (<CurLmtId> and <AllCurLmts> should never be found together in one request.)</p> <p>Remark: checked by ICM / Receipt</p>
25	P52			P052	<p>Error Text: BIC Bilateral Counterpart must not indicate a member of a Virtual Account.</p> <p>Validation: BilLmtCtrPtyId/BIC value must not indicate a member of a GoA Virtual Account. Instead it has to be used the BIC of the GoA manager to define the bilateral limit against the whole group.</p> <p>Remark: checked by ICM / Receipt</p>

ModifyLimit_PM_1

Scope: Modify Limit, modification of a current multilateral Limit on behalf of third party (Account Owner and Sender of the message are different)

Message name for ModifyLimit	<ModfyLmt>
Message Header	<MsgHdr>
Message Identification	<MsgId>ABCDEFGHIJKLMNOPQRSTUVWXYZabcdefghi</MsgId>
End of Message Header	</MsgId>
LimitDetails	<LmtDtls>
LimitIdentification	<LmtId>
CurrentLimit	<Cur>
Limit Type	<Tp>
Limit Type Code	<Cd>MULT</Cd>
End of Limit Type	</Tp>
Account Owner	<AcctOwnr>
Financial Institution Identification	<FinInstnId>
BICFIIdentifier	<BICFI>DEUTDEFFXXX</BICFI>
End of Financial Institution Identification	</FinInstnId>
End of Account owner	</AcctOwnr>
End of CurrentLimit	</Cur>
End of Limit Identification	</LmtId>
NewLimitValueSet	<NewLmtValSet>
Amount	<Amt>
Amount without currency	<AmtWthtCcy>80000000.00</AmtWthtCcy>
End of Amount	</Amt>
End of NewLimitValueSet	</NewLmtValSet>
End Limit details structure	</LmtDtls>
End of Message name for ModifyLimit	</ModfyLmt>

ModifyLimit_PM_2

Scope: Modify Limit: change current bilateral limit against counterpart

MessageName for ModifyLimit	<ModfyLmt>
Message Header	<MsgHdr>
Message Identification	<MsgId>ABC123</MsgId>
End of Message Header	</MsgHdr>
LimitDetails	<LmtDtls>
LimitIdentification	<LmtId>
CurrentLimit	<Cur>
BilateralLimitCounterpartyId	<BilLmtCtrPtyId>
Financial Institution Identification	<FinInstnId>
BICFIIdentifier	<BICFI>DEUTDEFF</BICFI>
End of Financial Institution Identification	</FinInstnId>
End of BilateralLimitCounterpartyId	</BilLmtCtrPtyId>
Limit Type	<Tp>
Limit Type Code	<Cd>BILI</Cd>
End of Limit Type	</Tp>
End of CurrentLimit	</Cur>
End of Limit Identification	</LmtId>
NewLimitValueSet	<NewLmtValSet>
Amount	<Amt>
Amount without currency	<AmtWthtCcy>5000000.00</AmtWthtCcy>
End of Amount	</Amt>
End of NewLimitValueSet	</NewLmtValSet>
End Limit details structure	</LmtDtls>
End of MessageName for ModifyLimit	</ModfyLmt>

ModifyLimit_PM_3

Scope: Modify Limit, modification of all current bilateral Limit on behalf of third party (Account Owner and Sender of the message are different).

MessageName for ModifyLimit	<ModfyLmt>
Message Header	<MsgHdr>
Message Identification	<Msgld>ABCDEFGHIJKL01234567890abcdefghijk</Msgld>
End of Message Header	</Msgld>
LimitDetails	<LmtDtls>
LimitIdentification	<Lmtld>
AllCurrentLimits	<AllCur>
Limit Type	<Tp>
Limit Type Code	<Cd>BILI</Cd>
End of Limit Type	</Tp>
Account Owner	<AcctOwnr>
Financial Institution Identification	<FinInstnld>
BICFIIdentifier	<BICFI>DEUTDEFFXXX</BICFI>
End of Financial Institution Identification	</FinInstnld>
End of Account owner	</AcctOwnr>
End of AllCurrentLimits	</AllCur>
End of Limit Identification	</Lmtld>
NewLimitValueSet	<NewLmtValSet>
Amount	<Amt>
Amount without currency	<AmtWthtCcy>10000000.00</AmtWthtCcy>
End of Amount	</Amt>
End of NewLimitValueSet	</NewLmtValSet>
End Limit details structure	</LmtDtls>
End of MessageName for ModifyLimit	</ModfyLmt>

6. 4.17 ModifyReservation

Cash Management Standard

ModifyReservation_PM

Scope: The ModifyReservation message is used to

- define a current reservation (highly urgent or urgent) which becomes effective immediately
- modify the current reservation (highly urgent or urgent) which becomes effective immediately

The ModifyReservation message can be sent by the application of a direct PM participant or the application of a group of accounts manager ("virtual account" reservation of liquidity possible for the whole group only, not for the single account holder).

If a participant is a member of an account group, the limit can only be defined against the whole group. Therefore reservation that are defined against an account group have to be defined against the account owner (BIC) of the leading account of the group.

The ModifyReservation message is replied by a Receipt message.
Non-Repudiation of Emission (NRE) is supported.

<camt.048.001.xx>

Structure:

Messsge name for ModifyReservation	<ModfyRsvatn>
Message Header	<MsgHdr>
Message Identification	<MsgId></MsgId>
End of Message Header	</MsgHdr>
CurrentOrDefaultReservation	<RsvatnId>
CurrentReservationId	<Cur>
ReservationType	<Tp>
ReservationTypeCode	<Cd></Cd>
End of ReservationType	</Tp>
Account Owner	<AcctOwnr>
Financial Institution Identification	<FinInstnId>
BICFIIdentifier	<BICFI></BICFI>
End of Financial Institution Identification	</FinInstnId>
End of Account owner	</AcctOwnr>
End of CurrentReservationId	</Cur>
End of CurrentOrDefaultReservation	</RsvatnId>
NewReservationValueSet	<NewRsvatnValSet>
Amount	<Amt>
Amount without currency	<AmtWthtCcy></AmtWthtCcy>
End of Amount	</Amt>
End of NewReservationValueSet	</NewRsvatnValSet>
End of messsge name for ModifyReservation	</ModfyRsvatn>

Attributes:

name of attribute	format	short description	description
<ModifyRsvatn>		Messsge name for ModifyReservation Mandatory A2A	Messsge name for ModifyReservation Validation:
<MsgHdr>		Message Header Mandatory A2A	Set of characteristics specific to the message Validation: [1..1]
<MsgId>-</MsgId>	35x	Message Identification Mandatory A2A	Message Identification Validation: [1..1]
</MsgHdr>		End of Message Header Mandatory A2A	Validation: [1..1]
<RsvatnId>		CurrentOrDefaultReservatio n Mandatory	CurrentOrDefaultReservation Validation: [1..1]
<Cur>		CurrentReservationId Mandatory A2A	CurrentReservationId Validation: [1..1]
<Tp>		ReservationType Mandatory A2A	ReservationType Validation: [1..1]
<Cd>-</Cd>		ReservationTypeCode Mandatory	ReservationTypeCode SSP restricted code list: UPAR = UrgentPaymentReservation Amount set aside by a participant to reserve liquidity from its own account, exclusively for executing urgent payments. HPAR = HighlyUrgentPayment reservation Amount set aside by a participant to reserve liquidity from its own account, exclusively for executing highly urgent payment Validation: [1..1]in PM only HPAR and UPAR are used
</Tp>		End of ReservationType Mandatory	End of ReservationType Validation: [1..1]
<AcctOwnr>		Account Owner Optional A2A	Validation: [0..1]
<FinInstnId>		Financial Institution Identification Mandatory	Financial Institution Identification Validation: [1..1]

name of attribute	format	short description	description
<BICFI>-</BICFI>	4!a2!a2!c3!c	BICFIIdentifier Mandatory	BICFIIdentifier in case of group of accounts BIC of the leading account of the group Validation: [1..1]mandatory when BIC RTGS main account is used on behalf of third parties, when not stated the BIC of the participant is used
</FinInstnId>		End of Financial Institution Identification Mandatory	End of Financial Institution Identification Validation: [1..1]
</AcctOwnr>		End of Account owner Optional	Validation: [0..1]
</Cur>		End of CurrentReservationId Mandatory A2A	End of CurrentReservationId Validation: [1..1]
</RsvatnId>		End of CurrentOrDefaultReservation Mandatory	End of CurrentOrDefaultReservation Validation: [1..1]
<NewRsvatnValSet>		NewReservationValueSet Mandatory A2A	NewReservationValueSet Validation: [1..1] new total amount for the reservation
<Amt>		Amount Mandatory A2A	Validation: [1..1]
<AmtWthtCcy>-</AmtWthtCcy>	18n	Amount without currency Mandatory A2A	Amount in EUR Validation: [1..1] in PM only 2 fraction digits are possible value restriction: maximum value 999.999.999.999,99
</Amt>		End of Amount Mandatory A2A	Validation: [1..1]
</NewRsvatnValSet>		End of NewReservationValueSet Mandatory A2A	End of NewReservationValueSet Validation: [1..1]
</ModfyRsvatn>		End of messsge name for ModifyReservation Mandatory A2A	End of messsge name for ModifyReservation Validation:

Error Codes:

Order	Error code				Error Text / Validation/ Remark
	SSP	Y-copy	V-shape	XML	
1	X00			0000	Error Text: O.k. Validation: Confirmation, that a task is stored in the task queue. A related reference for the subsequent processing (e.g. confirmation) of the task is returned. Remark: Receipt (status code)
2	X44			1404	Error Text: If "non repudiation of emission" is mandatory, the NRE indicator flag has to be present Validation: If non-repudiaton processing is mandatory, the tag <SwInt:NRIndicator>TRUE</SwInt:NRIndicator> has to be present. Remark: checked by ICM / Receipt
3	X41			1401	Error Text: No permission. RBAC User role(s) are not sufficient. Validation: RBAC role name "APPLICATE" or "APPLICBTE" are required Remark: checked by ICM / Receipt
4	X45			1405	Error Text: No authorisation or rather interaction not possible. User is not allowed acting on behalf of another participant as Group of Account manager Validation: CurRsvatnId/AcctOwnr (profile group of accounts manager) value must indicate the group of accounts manager Remark: checked by ICM / Receipt
5	X42			1402	Error Text: No authorisation. User is not allowed acting on behalf of another participant. Validation: CurRsvatnId/AcctOwnr (profile credit institution) value must indicate the credit institution itself or a participant who the credit institution is entitled to act on behalf of Remark: checked by ICM / Receipt
6	X47			1407	Error Text: No authorisation. User is not allowed acting on behalf of another Participant as Central Bank Validation: CurRsvatnId/AcctOwnr (profile central bank) value must indicate the central bank itself or a participant the central bank is responsible for Remark: checked by ICM / Receipt
7	X48			1408	Error Text: Interaction only possible for the virtual account manager Validation: Reservation of liquidity only possible for the Virtual account manager, for single account holders not possible Remark: checked by ICM / Receipt
8	X40			1400	Error Text: BIC must indicate a SSP participant Validation: BIC must indicate a SSP participant Remark: checked by ICM / Receipt
9	866	C6	AC06	2866	Error Text: Exclusion of participant Validation: If requestor is direct participant or ancillary system or GoA manager and this requestor is excluded, no change of data is allowed Remark: TaskQueue
10	894	K4		2894	Error Text: Function is not allowed in the current business day phase Validation: SSP is open Remark: TaskQueue
11	862	C2	TM01	2862	Error Text: Request out of cut-off time

Order	Error code				Error Text / Validation/ Remark
	SSP	Y-copy	V-shape	XML	
					Validation: Possibility to use this function during the current phase of business day. Remark: checked by PM / TaskQueue
12	P61			P061	Error Text: For accounts without non-liability of cover, this function is not allowed Validation: For accounts without non-liability of cover, liquidity reservation are not allowed Remark: TaskQueue

ModifyReservation_PM_1

Scope: Modify current reservation for highly urgent payments. Sending party and BIC SSP Participapnt are identic.

Messsge name for ModifyReservation	<ModfyRsvatn>
Message Header	<MsgHdr>
Message Identification	<MsgId>ABC123</MsgId>
End of Message Header	</MsgId>
CurrentOrDefaultReservation	<RsvatnId>
CurrentReservationId	<Cur>
ReservationType	<Tp>
ReservationTypeCode	<Cd>HPAR-</Cd>
End of ReservationType	</Tp>
End of CurrentReservationId	</Cur>
End of CurrentOrDefaultReservation	</RsvatnId>
NewReservationValueSet	<NewRsvatnValSet>
Amount	<Amt>
Amount without currency	<AmtWthtCcy>1000000.00</AmtWthtCcy>
End of Amount	</Amt>
End of NewReservationValueSet	</NewRsvatnValSet>
End of messsge name for ModifyReservation	</ModfyRsvatn>

ModifyReservation_PM_2

Scope: Modify current reservation for urgent payments. Behalf of scenario, Sending party and BIC SSP-Participant (AccountOwner) are different.

Messsge name for ModifyReservation	<ModfyRsvatn>
Message Header	<MsgHdr>
Message Identification	<MsgId>ABC123</MsgId>
End of Message Header	</MsgHdr>
CurrentOrDefaultReservation	<RsvatnId>
CurrentReservationId	<Cur>
ReservationType	<Tp>
ReservationTypeCode	<Cd>UPAR</Cd>
End of ReservationType	</Tp>
Account Owner	<AcctOwnr>
Financial Institution Identification	<FinInstnId>
BICFIIdentifier	<BICFI>DEUTDEFFXXX</BICFI>
End of Financial Institution Identification	</FinInstnId>
End of Account owner	</AcctOwnr>
End of CurrentReservationId	</Cur>
End of CurrentOrDefaultReservation	</RsvatnId>
NewReservationValueSet	<NewRsvatnValSet>
Amount	<Amt>
Amount without currency	<AmtWthtCcy>50000000.00</AmtWthtCcy>
End of Amount	</Amt>
End of NewReservationValueSet	</NewRsvatnValSet>
End of messsge name for ModifyReservation	</ModfyRsvatn>

6. 4.18 ModifySequence

SSP Proprietary Messages

ModifySequence_PM

Scope: The ModifySequence message is used to

- define or modify the sequence of accounts which will be used to fund the position for levelling out.

The group of accounts manager chooses the sequence of the accounts how they are used to fund debit balances on single accounts. There exist no level out sequence for sub accounts - they are balanced together with the corresponding RTGS account.

The ModifySequence message can be sent by the application of a

- group of accounts manager
- CB acting on behalf of a group of accounts manager

ModifySequence message is replied by a Receipt message.
Non-Repudiation of Emission (NRE) is supported.

<camt.998.001.xx>

Structure:

Name Proprietary message	<PrtryMsg>
Message Header	<MsgHdr>
Message Identification	<MsgId></MsgId>
End of Message Header	</MsgHdr>
Proprietary Data	<PrtryData>
Proprietary Data type	<Tp>ModifySequence</Tp>
Proprietary Data	<Data>
SSP Proprietary Data	<SspPrtryDt>
sequence identification	<Sqncld>
Account Owner	<AcctOwnr></AcctOwnr>
End sequence identification	</Sqncld>
New sequence details	<NewSqncValSet>
Member Participant BIC	<Mmbr>
BIC	<BIC></BIC>
End member Participant BIC	</Mmbr>
sequence	<Sqnc></Sqnc>
End new sequence details	</NewSqncValSet>
End of SSP Proprietary Data	</SspPrtryDt>
End of Proprietary Data	</Data>
End of Proprietary Data	</PrtryData>
End proprietary message	</PrtryMsg>

Attributes:

name of attribute	format	short description	description
<PrtryMsg>		Name Proprietary message Mandatory A2A	Validation:
<MsgHdr>		Message Header Mandatory A2A	Set of characteristics specific to the message Message Reference Validation: [1..1]
<MsgId>-</MsgId>	35x	Message Identification Mandatory A2A	Message Identification Validation: [1..1]
</MsgHdr>		End of Message Header Mandatory A2A	Validation: [1..1]
<PrtryData>		Proprietary Data Mandatory A2A	Proprietary Data Validation: [1..1]
<Tp>-</Tp>		Proprietary Data type Mandatory A2A	Proprietary Data type here only ModifySequence is possible Validation: [1..1]
<Data>		Proprietary Data Mandatory	Proprietary data content Validation: [1..1]
<SspPrtryDt>		SSP Proprietary Data Mandatory A2A	SSP Proprietary Data Validation: [1..1]
<Sqncld>		sequence identification Optional A2A	free format tag Validation: [0..1]
<AcctOwnr>-</AcctOwnr>	11x	Account Owner Mandatory A2A	BICIdentifier e.g. needed on behalf of third parties if e. g. the NCB are able to start several transactions on behalf their national banking community. BIC of the GoA manager (virtual account) / in case if the CB is acting on behalf, the GoA manager she is responsible for Validation: [1..1]
</Sqncld>		End sequence identification Optional A2A	free format tag Validation: [0..1]
<NewSqncValSet>		New sequence details	free format tag new sequence values

name of attribute	format	short description	description
		Mandatory A2A	Validation: [1..n]
<Mmbr>		Member Participant BIC	free format tag
		Mandatory A2A	Validation: [1..1]
<BIC>-</BIC>	4!a2!a2!c3!c	BIC	A code allocated to a financial institution by a Registration Authority under an international identification scheme, as described in the latest edition of the international standard ISO 9362 "Banking - Banking telecommunication messages - Bank identifier codes". BIC of the participant (RTGS account) which belongs to the group of accounts
		Mandatory A2A	Validation: [1..1]
</Mmbr>		End member Participant BIC	free format tag
		Mandatory A2A	Validation: [1..1]
<Sqnc>-</Sqnc>		sequence	free format tag level out sequence number (rank for levelling out) new sequence number The customer application has to make sure all members are stated and the numbers are unique. It is assumed that the enumeration is continuous beginning with 1 and the highest number is the number of group members. But this is not validated by SSP. Anyway, ICM sorts the datasets according their SequenceNumber value and gives new numbers beginning with 1. These calculated numbers are forwarded to and stored in PM. (If not all group members were stated a definite level out sequence cannot be guaranteed. - Same sequence numbers could occur several times.)
		Mandatory A2A	Validation: [1..1]positive integral number
</NewSqncValSet>		End new sequence details	free format tag
		Mandatory A2A	Validation: [1..n]
</SspPrtryDt>		End of SSP Proprietary Data	End of SSP Proprietary Data
		Mandatory A2A	Validation: [1..1]
</Data>		End of Proprietary Data	
		Mandatory	Validation: [1..1]
</PrtryData>		End of Proprietary Data	End of Proprietary Data
		Mandatory A2A	Validation: [1..1]
</PrtryMsg>		End proprietary message	
		Mandatory A2A	Validation:

Error Codes:

Order	Error code				Error Text / Validation/ Remark
	SSP	Y-copy	V-shape	XML	
1	X41			1401	Error Text: No permission. RBAC User role(s) are not sufficient. Validation: RBAC role name "APPLICATE" or "APPLICBTE" are required Remark: checked by ICM / Receipt
2	X40			1400	Error Text: BIC must indicate a SSP participant Validation: BIC must indicate a SSP participant Remark: checked by ICM / Receipt
3	X42			1402	Error Text: No authorisation. User is not allowed acting on behalf of another participant. Validation: AcctOwnr (profile CI) value must indicate the CI itself or a participant the CI is entitled to act on behalf of Remark: checked by ICM / Receipt
4	X51			1411	Error Text: The selected participant is no Group of Accounts Manager Validation: AcctOwnr (profile CI) CI must be a GoA manager Remark: checked by ICM / Receipt
5	X47			1407	Error Text: No authorisation. User is not allowed acting on behalf of another Participant as Central Bank Validation: AcctOwnr (profile CB) value must indicate the CB itself or a participant the CB is responsible for Remark: checked by ICM / Receipt
6	X51			1411	Error Text: The selected participant is no Group of Accounts Manager Validation: AcctOwnr (profile CB) value must indicate a GoA manager the CB is responsible for Remark: checked by ICM / Receipt
7	X45			1405	Error Text: No authorisation or rather interaction not possible. User is not allowed acting on behalf of another participant as Group of Account manager Validation: AcctOwnr (profile GoA) value must indicate a member of the group of accounts the participant is the manager of Remark: checked by ICM / Receipt
8	X51			1411	Error Text: The selected participant is no Group of Accounts Manager Validation: AcctOwnr (profile GoA) value must indicate the GoA manager himself Remark: checked by ICM / Receipt
9	X47			1407	Error Text: No authorisation. User is not allowed acting on behalf of another Participant as Central Bank Validation: Mmbr/BIC (profile CB) value must indicate a participant which belongs to the virtual account Id (the group of accounts) Remark: checked by ICM / Receipt
10	X45			1405	Error Text: No authorisation or rather interaction not possible. User is not allowed acting on behalf of another participant as Group of Account manager Validation: Mmbr/BIC (profile GoA) value must indicate a participant the GoA manager responsible for Remark: checked by ICM / Receipt
11	862	C2	TM01	2862	Error Text: Request out of cut-off time Validation: Possibility to use this function during the current phase of business day.

Order	Error code				Error Text / Validation/ Remark
	SSP	Y-copy	V-shape	XML	
					Remark: checked by PM / TaskQueue
12	866	C6	AC06	2866	Error Text: Exclusion of participant Validation: If requestor is direct participant or ancillary system or GoA manager and this requestor is excluded, no change of data is allowed Remark: TaskQueue
13	P38			P038	Error Text: BICs have to be unique - A group member may only have one sequence number. Validation: The BICs in fields NewSqncValSet/Mmbr/BIC have to be unique Remark: checked by ICM / Receipt

ModifySequence_PM_1

Scope: CB is acting on behalf of the GoA manager (BIC DRESDEFFXXX)

Name Proprietary message	<PrtryMsg>
Message Header	<MsgHdr>
Message Identification	<MsgId>ABC123</MsgId>
End of Message Header	</MsgHdr>
Proprietary Data	<PrtryData>
Proprietary Data type	<Tp>ModifySequence</Tp>
Proprietary Data	<Data>
SSP Proprietary Data	<SspPrtryDt>
sequence identification	<SqncId>
Account Owner	<AcctOwnr>DRESDEFFXXX</AcctOwnr>
End sequence identification	</SqncId>
New sequence details	<NewSqncValSet>
Member Participant BIC	<Mmbr>
BIC	<BIC>DRESDE2H264</BIC>
End member Participant BIC	</Mmbr>
sequence	<Sqnc>1</Sqnc>
End new sequence details	</NewSqncValSet>
New sequence details	<NewSqncValSet>
Member Participant BIC	<Mmbr>
BIC	<BIC>DEUTDE8C871</BIC>
End member Participant BIC	</Mmbr>
sequence	<Sqnc>2</Sqnc>
End new sequence details	</NewSqncValSet>
New sequence details	<NewSqncValSet>
Member Participant BIC	<Mmbr>
BIC	<BIC>DEUTDEHB290</BIC>
End member Participant BIC	</Mmbr>
sequence	<Sqnc>3</Sqnc>
End new sequence details	</NewSqncValSet>
End of SSP Proprietary Data	</SspPrtryDt>
End of Proprietary Data	</Data>
End of Proprietary Data	</PrtryData>
End proprietary message	</PrtryMsg>

ModifySequence_PM_2

Scope: Requestor is the GoA manager of the group of accounts (DRESDE2H264, DEUTDE8C871 and DEUTDEHB290)

Name Proprietary message	<PrtryMsg>
Message Header	<MsgHdr>
Message Identification	<MsgId>ABC123</MsgId>
End of Message Header	</MsgHdr>
Proprietary Data	<PrtryData>
Proprietary Data type	<Tp>ModifySequence</Tp>
Proprietary Data	<Data>
SSP Proprietary Data	<SspPrtryDt>
New sequence details	<NewSqncValSet>
Member Participant BIC	<Mmbr>
BIC	<BIC>DRESDE2H264</BIC>
End member Participant BIC	</Mmbr>
sequence	<Sqnc>1</Sqnc>
End new sequence details	</NewSqncValSet>
New sequence details	<NewSqncValSet>
Member Participant BIC	<Mmbr>
BIC	<BIC>DEUTDE8C871</BIC>
End member Participant BIC	</Mmbr>
sequence	<Sqnc>2</Sqnc>
End new sequence details	</NewSqncValSet>
New sequence details	<NewSqncValSet>
Member Participant BIC	<Mmbr>
BIC	<BIC>DEUTDEHB290</BIC>
End member Participant BIC	</Mmbr>
sequence	<Sqnc>3</Sqnc>
End new sequence details	</NewSqncValSet>
End of SSP Proprietary Data	</SspPrtryDt>
End of Proprietary Data	</Data>
End of Proprietary Data	</PrtryData>
End proprietary message	</PrtryMsg>

6. 4.19 ModifyTransaction

Cash Management Standard

ModifyTransaction_PM

Scope: The ModifyTransaction message is used to manage the payment queue. Using this message it is possible to change the

- sequence (to the top or to the bottom of the queue (= reordering))
- priority
- execution time (earliest and latest debit time)

pending payments in the queue.

The ModifyTransaction message can be sent by a CI application of a single PM account holder or the application of a GoA manager for Virtual Account. Alternatively a CB application can send this message on behalf of other participants she is responsible for. - Reordering of AS payments is only enabled for CB's on behalf of their settlement banks. (for detailed information please check section "Error codes")

The ModifyTransaction message is replied by a Receipt message.
Non-Repudiation of Emission (NRE) is mandatory.

<camt.007.001.xx>

Structure:

Message name for ModifyTransaction	<ModifyTx>
Message Header	<MsgHdr>
Message Identification	<MsgId></MsgId>
End of Message Header	</MsgHdr>
TransactionModification	<Mod>
PaymentIdentification	<PmtId>
Choice	xorLngBizIdPrtryId
LongBusinessIdentification	<LngBizId>
TransactionIdentification 16x	<TxId></TxId>
ImpliedCurrencyAndAmount	<IntrBkSttlmAmt></IntrBkSttlmAmt>
Value date	<IntrBkSttlmDt></IntrBkSttlmDt>
PaymentMethod	<PmtMtd>
Choice	xorFINMTPrtry
FINMessageType	<FINMT></FINMT>
ProprietaryPaymentOriginType	<Prtry></Prtry>
End of Choice	/xorFINMTPrtry
End of Payment Method	</PmtMtd>
Instructing Agent	<InstgAgt>
Financial Institution Identification	<FinInstnId>
BICFIIdentifier	<BICFI></BICFI>
End of Financial Institution Identification	</FinInstnId>
End of Instructing Agent	</InstgAgt>
Instructed Agent	<InstdAgt>
Financial Institution Identification	<FinInstnId>
BICFIIdentifier	<BICFI></BICFI>
End of Financial Institution Identification	</FinInstnId>
End of Instructed Agent	</InstdAgt>
EndToEndIdentification	<EndToEndId></EndToEndId>
End LongBusinessIdentification	</LngBizId>
ProprietaryId	<PrtryId></PrtryId>
End of choice	/xorLngBizIdPrtryId
EndPaymentIdentification	</PmtId>
NewPaymentValueSet	<NewPmtValSet>
choice amongst	xorPrtyPrcgVldtyTm
Priority	<Prty>
choice amongst	xorCdPrtryCd
Priority Code	<Cd></Cd>

ProprietaryCode	<PrtryCd></PrtryCd>
End choice amongst	/xorCdPrtryCd
End Priority	</Prty>
ProcessingValidityTime	<PrcgVldtyTm>
choice	xorFrDtTmToDtTm
FromDateTime	<FrDtTm></FrDtTm>
ToDateTime	<ToDtTm></ToDtTm>
End of choice	/xorFrDtTmToDtTm
End of ProcessingValidityTime	</PrcgVldtyTm>
End choice amongst	/xorPrtyPrcgVldtyTm
End NewPaymentValueSet	</NewPmtValSet>
End of Modification	</Mod>
End of Messagename for ModifyTransaction	</ModfyTx>

Attributes:

name of attribute	format	short description	description
<ModifyTx>		Message name for ModifyTransaction Mandatory A2A	Message name for ModifyTransaction Validation:
<MsgHdr>		Message Header Mandatory A2A	Set of characteristics specific to the message Validation: [1..1]
<MsgId>-</MsgId>	35x	Message Identification Mandatory A2A	Message Identification Validation: [1..1]
</MsgHdr>		End of Message Header Mandatory A2A	Validation: [1..1]
<Mod>		TransactionModification Mandatory A2A	This element contains both the PaymentId and the NewPaymentValueSet Validation: *****[1..1] differs from the cash management standard SSP currently supports only one payment modification per request.
<PmtId>		PaymentIdentification Mandatory A2A	Set of elements to provide further means of referencing a payment transaction unique and unambiguous identification of a payment Validation: [1..1] in PM only <PrtryRef> used
xorLngBizIdPrtryId		Choice Mandatory	PaymentIdentificationChoice: Choice between <LngBizId> and <PrtryId> Validation:
<LngBizId>		LongBusinessIdentification Mandatory	Identifies a payment instruction by a set of characteristics which provides an unambiguous identification of the instruction. TransactionIdentification InterBankSettlementAmount InterBankSettlementDate PaymentMethod InstructingAgent InstructedAgent EndToEndIdentification Validation: [1..1]
<TxId>-</TxId>	16x	TransactionIdentification 16x Mandatory	Unique and unambiguous identification of a payment transaction, as assigned by the originator. The payment transaction reference is used for reconciliation or to link tasks relating to the payment transaction. Validation: [1..1]
<IntrBkSttlmAmt>-</IntrBkSttlmAmt>		ImpliedCurrencyAndAmount Mandatory	ImpliedCurrencyAndAmount Validation: [1..1]

name of attribute	format	short description	description
<IntrBkSttlmDt>- </IntrBkSttlmDt>	ISODate	Value date Mandatory	Value date Validation: [1..1]
<PmtMtd>		PaymentMethod Mandatory	PaymentMethod Validation: [1..1]
xorFINMTPrtry		Choice Mandatory	Choice amongst <FINMT> and <Prtry> Validation:
<FINMT>-</FINMT>	3x	FINMessageType Mandatory	possible values: 103 202 204 Validation: [1..1]
<Prtry>-</Prtry>	6c	ProprietaryPaymentOriginT ype Mandatory	ASXML = Bookings stemming from incoming AS XML payments T2SXML = Bookings stemming from incoming T2S XML payments T2SXML = Bookings stemming from incoming TIPS XML payments INTERN = Bookings stemming from internal messages ORDER = Bookings stemming from current orders sent via ICM Validation: [1..1]Only the values ASXML, T2SXML, TIPSXML, INTERN and ORDER are allowed: ASXML: The result set will include all bookings stemming from an incoming AS XML payments (incl. SBTransferInitiation). T2SXML: The result set will include all bookings stemming from an incoming T2S XML payments INTERN: The result set will include all bookings stemming from internal messages: - Automatic processing by PM, including Standing Orders - Payments delivered from HAM (e.g. Simplified MT202), RM, SF, CRISP, CM ORDER: The result set will include all bookings stemming from current orders sent via ICM. (E.g. Backup Payments. - But not SBTransferInitiation.)
/xorFINMTPrtry		End of Choice Mandatory	Validation:
</PmtMtd>		End of Payment Method Mandatory	End of Payment Method Validation: [1..1]
<InstgAgt>		Instructing Agent Mandatory	Instructing Agent Validation: [1..1]
<FinInstnId>		Financial Institution Identification Mandatory	Financial Institution Identification Validation: [1..1]

name of attribute	format	short description	description
<BICFI>-</BICFI>	4!a2!a2!c3!c	BICFIIdentifier Mandatory	BICFIIdentifier - Sender - FirstAgent BIC in case of AS XML payments Validation: [1..1]
</FinInstnId>		End of Financial Institution Identification Mandatory	End of Financial Institution Identification Validation: [1..1]
</InstgAgt>		End of Instructing Agent Mandatory	End of Instructing Agent Validation: [1..1]
<InstdAgt>		Instructed Agent Mandatory	Instructed Agent Validation: [1..1]
<FinInstnId>		Financial Institution Identification Mandatory	Financial Institution Identification Validation: [1..1]
<BICFI>-</BICFI>	4!a2!a2!c3!c	BICFIIdentifier Mandatory	BICFIIdentifier - Receiver - FinalAgent BIC in case of AS XML payments Validation: [1..1]
</FinInstnId>		End of Financial Institution Identification Mandatory	End of Financial Institution Identification Validation: [1..1]
</InstdAgt>		End of Instructed Agent Mandatory	End of Instructed Agent Validation: [1..1]
<EndToEndId>-</EndToEndId>	16x	EndToEndIdentification Optional	Unique and unambiguous identification of a payment transaction, as assigned by any of the parties on the initiating side, that will be passed on throughout the entire end-to-end chain Validation: [0..1]
</LngBizId>		End LongBusinessIdentification Mandatory	End LongBusinessIdentification Validation: [1..1]
<PrtryId>-</PrtryId>	16n	ProprietaryId Mandatory A2A	ProprietaryId SSP Booking ID (generated by PM [16x]; unique identifier of a booking) - delivered within the ReturnTransaction message Validation: [1..1] Only transactions with an unambiguous SSP-Reference can be modified. Decrease / increase / change priority: MT204: value must indicate a transaction received by a participant or a CB, GoA who is entitled / responsible to act on behalf of the participant.

name of attribute	format	short description	description
			Decrease / increase / change priority: MT103, 202: value must indicate a transaction sent by a participant or a CB, GoA who is entitled / responsible to act on behalf of the participant. Change time: value must indicate a transaction sent by a participant or a CB, GoA who is entitled / responsible to act on behalf of the participant.
/xorLngBizIdPrtryId		End of choice Mandatory	End of PaymentIdentificationChoice Validation:
</PmtId>		EndPaymentIdentification Mandatory A2A	End of Set of elements to reference a payment transaction Validation: [1..1]
<NewPmtValSet>		NewPaymentValueSet Mandatory A2A	Instruction to pay an amount of money to an ultimate beneficiary, on behalf of an originator. This instruction may have to be forwarded several times to complete the settlement chain. Instruction [0..1] PaymentType [0..1] Priority [0..1] ProcessingValidityTime [0..1] Validation: [1..1] In PM Instruction [0..1] and PaymentType [0..1] are not needed. In contrast to the cash management standard, there is only the possibility to modify the Priority or the Processing Validity Time. For this reason it's not feasible to put both modification in one request. Change Priority, Change Earliest Debit Time and Change Latest Debit Time are only possible for status of payments queued and earmarked.
xorPrtyPrcgVldtyTm		choice amongst Mandatory A2A	choice amongst Priority and ProcessingValidityTime Validation: in PM different from the SWIFT cash management standard only one modification is possible <Prty> or <PrcgVldtyTm>
<Prty>		Priority Mandatory A2A	The relative urgency or order of importance that the originator would like the recipient of the payment instruction to apply to the processing of the payment instruction. Code [1..1] PriorityCode PriorityCodeChoice ProprietaryCode [1..1] Max4AlphaNumericText Priority Validation: ****[1..1] because of the rule choice in PM between <Prty> or <PrcgVldtyTm> the field is mandatory and differs consequently from the cash management standard
xorCdPrtryCd		choice amongst Mandatory	PriorityCodeChoice Code [1..1] Priority Code ProprietaryCode [1..1] Max4AlphaNumericText Validation:

name of attribute	format	short description	description
		A2A	
<Cd>		Priority Code	Specifies the priority level of an event. LOWW = Low Priority level is low. NORM = Normal Priority level is normal. Priority Validation: [1..1] The priority of a payment can only be changed if the payment is not yet final or returned because of revoke or reject. Normal = NORM is defined in PM as = urgent Priority Low = LOWW is defined in PM as = normal Priority Priority: Only the sender of a payment, his central bank is able to change the priority of the payment. The function cannot be used in case of payments from/to excluded participants. It is not possible to change from or to highly urgent priority.
		Mandatory	
		A2A	
<PrtryCd>-</PrtryCd>	4x	ProprietaryCode	Priority code bilaterally defined between parties. Specifies the priority level of an event. Reordering Queue Validation: [1..1] In this Case in PM used as action parameter DECR = Decrease INCR = Increase Increase and Decrease are only usable for payments with status open-pending. Increase and Decrease only the debtor of a payment, his central bank or user group profile SSP is able to increase the payment. This function cannot be used in case of payments from/to excluded participants.
		Mandatory	
		A2A	
/xorCdPrtryCd		End choice amongst	end choice amongst PriorityCodeChoice Code [1..1] Priority Code ProprietaryCode [1..1] Max4AlphaNumericText
		Mandatory	Validation:
		A2A	
</Prty>		End Priority	End of priority
		Mandatory	Validation:
		A2A	[1..1]
<PrcgVldtyTm>		ProcessingValidityTime	Date and time range within which the payment instruction must be processed.
		Mandatory	Validation:
		A2A	*****[1..1] because of the rule choice in PM between <Prty> or <PrcgVldtyTm> the field is mandatory and differs consequently from the cash management standard Earliest Debit Time and Latest Debit Time: Only the sender of a payment, his central bank or user group profile SSP is able to change the priority of the payment. The function cannot be used in case of payments from/to excluded participants. In case of Valuta BackupPayments with an old date - the elements <FrDtTm> or rather <ToDtTm> the date within, has to be the SSP Business date
xorFrDtTmToDtTm		choice	DateTimePeriodChoice FromDateTime [1..1] ToDateTime [1..1]

name of attribute	format	short description	description
		Mandatory A2A	Validation: choice amongst <FrDtTm>, <ToDtTm>
<FrDtTm>-</FrDtTm>	ISODateTime	FromDateTime Mandatory A2A	Date and time at which the range starts. New Earliest Execution Debit Time (FROTIME), Only the sender (MT204 creditor / MT103, 202 debtor) of a payment, his central bank is able to change the execution time of the payment. Validation: [1..1] in PM used to change Earliest debit time. The new Earliest Debit Time (FROTIME) cannot be earlier than the opening time of SSP. Date within the ISODateTime must indicate the date of current value date
<ToDtTm>-</ToDtTm>	ISODateTime	ToDateTime Mandatory A2A	Date and time at which the range ends. New Latest Debit Time (TILTIME) Validation: [1..1] in PM used to change latest debit time. The New Latest Debit Time (TILTIME, REJTIME, CLSTIME) cannot be later than the closing time of SSP. The date within the ISODateTime must indicate the date of current value date
/xorFrDtTmToDtTm		End of choice Mandatory A2A	end of choice Validation: end of choice amongst <FrDtTm>, <ToDtTm>
</PrcgVldtyTm>		End of ProcessingValidityTime Mandatory A2A	End of ProcessingValidityTime Validation: [1..1]
/xorPrtyPrcgVldtyTm		End choice amongst Mandatory A2A	end choice amongst Priority and ProcessingValidityTime Validation:
</NewPmtValSet>		End NewPaymentValueSet Mandatory A2A	End of NewPaymentValueSet Validation: [1..1]
</Mod>		End of Modification Mandatory A2A	Validation: *****[1..1]
</ModifyTx>		End of Messagename for ModifyTransaction Mandatory A2A	Validation:

Error Codes:

Order	Error code				Error Text / Validation/ Remark
	SSP	Y-copy	V-shape	XML	
1	X00			0000	<p>Error Text: O.k.</p> <p>Validation: Confirmation, that a task is stored in the task queue. A related reference for the subsequent processing (e.g. confirmation) of the task is returned.</p> <p>Remark: Receipt (status code)</p>
2	X44			1404	<p>Error Text: If "non repudiation of emission" is mandatory, the NRE indicator flag has to be present</p> <p>Validation: If non-repudiaton processing is mandatory, the tag <SwInt:NRIndicator>TRUE</SwInt:NRIndicator> has to be present.</p> <p>Remark: checked by ICM / Receipt</p>
3	X41			1401	<p>Error Text: No permission. RBAC User role(s) are not sufficient.</p> <p>Validation: RBAC role name "APPLICATE", "APPLICSTE" or "APPLICBTE" are required</p> <p>Remark: checked by ICM / Receipt</p>
4	P80			P110	<p>Error Text: You are not allowed to increase/decrease the payment(s)</p> <p>Validation: InstrRef for increase/decrease modification (profile credit institution) value must indicate a transaction sent by the credit institution itself or by a participant the credit institution is entitled to act on behalf of</p> <p>Remark: checked by ICM/ Receipt</p>
5	P81			P111	<p>Error Text: You are not allowed to change the priority of the payment(s)</p> <p>Validation: InstrRef for priority modification (profile group of account manager) value must indicate a transaction sent by a group of account manager the participant is manager of</p> <p>Remark: checked by ICM/ Receipt</p>
6	P80			P110	<p>Error Text: You are not allowed to increase/decrease the payment(s)</p> <p>Validation: InstrRef for increase/decrease modification (profile group of account manager) value must indicate a transaction for which the group of account manager is responsible for</p> <p>Remark: checked by ICM/ Receipt</p>
7	P81			P111	<p>Error Text: You are not allowed to change the priority of the payment(s)</p> <p>Validation: InstrRef for priority modification (profile central bank) value must indicate a transaction sent by a participant the central bank is responsible for</p> <p>Remark: checked by ICM/ Receipt</p>
8	X47			1407	<p>Error Text: No authorisation. User is not allowed acting on behalf of another Participant as Central Bank</p> <p>Validation: InstrRef for increase/decrease modification (profile central bank) value must indicate a transaction sent by a participant the Central Bank is responsible for. Exceptions for this rule: AS payments from settlement model 1 to 4 can be reordered by CBs (1) if they are responsible for the Settlement Bank to be debited. - (2) In case the Settlement Bank is member of a Virtual Account, only the responsible CB of the Virtual Account Manager is able to increase / decrease the AS payment. If the manager's CB is not responsible for the Settlement Bank the U2A mode has to be used.</p> <p>Remark: checked by ICM/ Receipt</p>
9	P81			P111	<p>Error Text: You are not allowed to change the priority of the payment(s)</p> <p>Validation: InstrRef for priority modification (profile credit institution) value must indicate a transaction sent by the credit institution itself or by a participant the credit institution is entitled to act on behalf of</p> <p>Remark: checked by ICM/ Receipt</p>

Order	Error code				Error Text / Validation/ Remark
	SSP	Y-copy	V-shape	XML	
10	P83			P113	<p>Error Text: You are not allowed to change the Latest Debit Time of the payment(s)</p> <p>Validation: InstrRef for modification of latest debit time (profile group of account manager): value must indicate a transaction sent by a group of account manager the participant is manager of</p> <p>Remark: checked by ICM/ Receipt</p>
11	P83			P113	<p>Error Text: You are not allowed to change the Latest Debit Time of the payment(s)</p> <p>Validation: InstrRef for modification of latest debit time (profile credit institution) value must indicate a transaction sent by the credit institution itself or by a participant the credit institution is entitled to act on behalf of</p> <p>Remark: checked by ICM/ Receipt</p>
12	P83			P113	<p>Error Text: You are not allowed to change the Latest Debit Time of the payment(s)</p> <p>Validation: InstrRef for modification of latest debit time (profile central bank) value must indicate a transaction sent by a participant the central bank is responsible for</p> <p>Remark: checked by ICM/ Receipt</p>
13	P82			P112	<p>Error Text: You are not allowed to change the Earliest Debit Time of the payment(s)</p> <p>Validation: InstrRef for modification of earliest debit time (profile group of account manager): value must indicate a transaction sent by a group of account manager the participant is manager of</p> <p>Remark: checked by ICM/ Receipt</p>
14	P82			P112	<p>Error Text: You are not allowed to change the Earliest Debit Time of the payment(s)</p> <p>Validation: InstrRef for modification of earliest debit time (profile credit institution) value must indicate a transaction sent by the credit institution itself or by a participant the credit institution is entitled to act on behalf of</p> <p>Remark: checked by ICM/ Receipt</p>
15	P82			P112	<p>Error Text: You are not allowed to change the Earliest Debit Time of the payment(s)</p> <p>Validation: InstrRef for modification of earliest debit time (profile central bank) value must indicate a transaction sent by a participant the central bank is responsible for</p> <p>Remark: checked by ICM/ Receipt</p>
16	P80			P110	<p>Error Text: You are not allowed to increase/decrease the payment(s)</p> <p>Validation: Increase and Decrease: Only the debtor (MT204 receiver / sender MT202/103) of a payment, his central bank is able to increase the payment.</p> <p>Remark: checked by ICM/ Receipt</p>
17	P81			P111	<p>Error Text: You are not allowed to change the priority of the payment(s)</p> <p>Validation: Priority: Only the debtor (MT204 receiver / sender MT202/103) of a payment, his central bank or is able to change the priority of the payment</p> <p>Remark: checked by ICM/ Receipt</p>
18	P95			P125	<p>Error Text: Date is not the current value date</p> <p>Validation: ToDtTm: date within the ISODateTime must indicate the date of current value date</p> <p>Remark: checked by ICM/ Receipt</p>
19	P95			P125	<p>Error Text: Date is not the current value date</p> <p>Validation: FrDtTm: date within the ISODateTime must indicate the date of current value date</p>

Order	Error code				Error Text / Validation/ Remark
	SSP	Y-copy	V-shape	XML	
					Remark: checked by ICM/ Receipt
20	P96	T3		P126	Error Text: Date is not the current SSP business day Validation: only for backup payments with valuta date in the past ToDtTm: date within the ISODateTime must indicate the current SSP business date. Remark: checked by ICM/ Receipt
21	P96	T3		P126	Error Text: Date is not the current SSP business day Validation: only for backup payments with valuta date in the past FrDtTm: date within the ISODateTime must indicate the current SSP business date. Remark: checked by ICM/ Receipt
22	P93			P123	Error Text: Requested time must be later than the current system time. Validation: ToDtTm value cannot be earlier than the current system time Remark: checked by ICM/ Receipt
23	894	K4		2894	Error Text: Function is not allowed in the current business day phase Validation: SSP is open Remark: TaskQueue
24	866	C6	AC06	2866	Error Text: Exclusion of participant Validation: If requestor is direct participant or ancillary system or GoA manager and this requestor is excluded, no change of data is allowed Remark: TaskQueue
25	P93			P123	Error Text: Requested time must be later than the current system time. Validation: FrDtTm value cannot be earlier than the current system time Remark: checked by ICM/ Receipt
26	862	C2	TM01	2862	Error Text: Request out of cut-off time Validation: Possibility to use this function during the current phase of business day. Remark: checked by PM / TaskQueue
27	X40			1400	Error Text: BIC must indicate a SSP participant Validation: BIC must indicate a SSP participant Remark: TaskQueue
28	P92			P122	Error Text: New Latest Debit Time is before specified Earliest Debit Time Validation: New Latest Debit Time is before specified Earliest Debit Time Remark: TaskQueue
29	P85			P115	Error Text: Requested time must be before closing time of SSP Validation: Validation is against the cut-off time of the respective FIN message type (e.g. MT103 etc.) Remark: TaskQueue
30	P83			P113	Error Text: You are not allowed to change the Latest Debit Time of the payment(s) Validation: Latest Debit Time: Only the sender of a payment, his central bank is able to change the Latest DebitTime of a payment. Remark: TaskQueue

Order	Error code				Error Text / Validation/ Remark
	SSP	Y-copy	V-shape	XML	
31	P89			P119	Error Text: New setting of earliest or latest debit time is not possible. Validation: modification debit time: earliest and latest debit time has to be specified Remark: TaskQueue
32	P94			P124	Error Text: Requested time must be later than opening time of SSP Validation: New Latest Debit Time cannot be earlier than the opening time of SSP Remark: TaskQueue
33	P94			P124	Error Text: Requested time must be later than opening time of SSP Validation: New Earliest Debit Time cannot be earlier than the opening time of SSP Remark: TaskQueue
34	P89			P119	Error Text: New setting of earliest or latest debit time is not possible. Validation: changing the earliest or latest debit time is only possible if the message was delivered to SSP including set times. New setting of debit times is not possible. Remark: TaskQueue
35	P85			P115	Error Text: Requested time must be before closing time of SSP Validation: debit time has to within the time span of SSP Remark: TaskQueue
36	P91			P121	Error Text: New Earliest DebitTime is after the permitted Latest DebitTime Validation: earliest debit time must before latest debit time Remark: TaskQueue
37	P78			P108	Error Text: Function is only available for status open-pending. Validation: Increase or decrease of payment:the status of the payment must not be earmarked or final. Remark: TaskQueue
38	P70			P100	Error Text: Function is only possible for AS: "info period", all other: "warehoused", "pending" (but not for change earliest debit time) and "earmarked" Validation: the payment must not be final Remark: TaskQueue
39	P13			P013	Error Text: No payment found Validation: PrtryRef does exist and is valid Remark: TaskQueue
41	P72			P102	Error Text: Function is not available for AS payments Validation: change earliest and latest debit time not available for AS payments Remark: TaskQueue
42	P73			P103	Error Text: Function is not available for AS payments settlement procedure 5 and 6 Validation: Increase and decrease not available for AS payments settlement model 5 and 6. Remark: TaskQueue
43	P72			P102	Error Text: Function is not available for AS payments Validation: change priority not available for AS payments

Order	Error code				Error Text / Validation/ Remark
	SSP	Y-copy	V-shape	XML	

Remark: TaskQueue

ModifyTransaction_PM_1

Scope: ModifyTransaction sent to change the priority of a payment to urgent (Priority Code: NORM)

MessageName for ModifyTransaction	<ModfyTx>
Message Header	<MsgHdr>
Message Identification	<Msgld>ABC12345</Msgld>
End of Message Header	</Msgld>
TransactionModification	<Mod>
PaymentIdentification	<Pmtld>
ProprietaryId	<Prtryld>1237</Prtryld>
EndPaymentIdentification	</Pmtld>
NewPaymentValueSet	<NewPmtValSet>
Priority	<Prty>
Priority Code	<Cd>NORM</Cd>
End Priority	</Prty>
End NewPaymentValueSet	</NewPmtValSet>
End of Modification	</Mod>
End of MessageName for ModifyTransaction	</ModfyTx>

ModifyTransaction_PM_2

Scope: ModifyTransaction sent for reordering a transaction in the queue (on top, on bottom) - here: decrease

MessageName for ModifyTransaction	<ModfyTx>
Message Header	<MsgHdr>
Message Identification	<MsgId>ABC1233</MsgId>
End of Message Header	</MsgHdr>
TransactionModification	<Mod>
PaymentIdentification	<PmtId>
ProprietaryId	<PrtryId>1234567890123456</PrtryId>
EndPaymentIdentification	</PmtId>
NewPaymentValueSet	<NewPmtValSet>
Priority	<Prty>
ProprietaryCode	<PrtryCd>DECR</PrtryCd>
End Priority	</Prty>
End NewPaymentValueSet	</NewPmtValSet>
End of Modification	</Mod>
End of MessageName for ModifyTransaction	</ModfyTx>

ModifyTransaction_PM_3

Scope: ModifyTransaction sent to change the earliest execution time of a payment

MessageName for ModifyTransaction	<ModfyTx>
Message Header	<MsgHdr>
Message Identification	<MsgId>PM12345</MsgId>
End of Message Header	</MsgHdr>
TransactionModification	<Mod>
PaymentIdentification	<PmtId>
ProprietaryId	<PrtryId>1237</PrtryId>
EndPaymentIdentification	</PmtId>
NewPaymentValueSet	<NewPmtValSet>
ProcessingValidityTime	<PrcgVldtyTm>
FromDateTime	<FrDtTm>2008-07-21T08:35:30</FrDtTm>
End of ProcessingValidityTime	</PrcgVldtyTm>
End NewPaymentValueSet	</NewPmtValSet>
End of Modification	</Mod>
End of MessageName for ModifyTransaction	</ModfyTx>

ModifyTransaction_PM_4

Scope: ModifyTransaction sent to change latest execution time of a payment

MessageName for ModifyTransaction	<ModifyTx>
Message Header	<MsgHdr>
Message Identification	<MsgId>PM1235</MsgId>
End of Message Header	</MsgHdr>
TransactionModification	<Mod>
PaymentIdentification	<InstrRef>
ProprietaryId	<PrtryId>1234567890123456</PrtryId>
EndPaymentIdentification	</PmtId>
NewPaymentValueSet	<NewPmtValSet>
ProcessingValidityTime	<PrcgVldtyTm>
ToDateTime	<ToDtTm>2004-07-21T09:35:30</ToDtTm>
End of ProcessingValidityTime	</PrcgVldtyTm>
End NewPaymentValueSet	</NewPmtValSet>
End of Modification	</Mod>
End of MessageName for ModifyTransaction	</ModifyTx>

6. 4.20 ReleasePayment (for CBs only)

SSP Proprietary Messages

ReleasePayment_PM

Scope: The Release payment message is used to agree or disagree payments from/to excluded participants or for excluded Ancillary Systems for further processing.

The request/function is only foreseen on single transaction basis. The "Agree", "Disagree"-function is not supported for complete files.

"Agree", "Disagree" are only possible, if the status of payment is "Accounting Stopped due to exclusion" during the current business day.

To identify the payment to be released the CB has to use the SSP Booking ID. The SSP Booking ID <PrtryRef> will be reported within response to a GetTransaction request (in ReturnTransaction).

The ReleasePayment message is replied by a Receipt message.

<camt.998.001.xx>

Structure:

Name Proprietary message	<PrtryMsg>
Message Header	<MsgHdr>
Message Identification	<MsgId></MsgId>
End of Message Header	</MsgHdr>
Proprietary Data	<PrtryData>
Proprietary Data type	<Tp>ReleasePayment</Tp>
Proprietary Data	<Data>
SSP Proprietary Data	<SspPrtryDt>
InstructionReference	<InstrRef>
Choice	xorLngBizIdPrtryId
LongBusinessIdentification	<LngBizId>
TransactionIdentification 16x	<TxId></TxId>
ImpliedCurrencyAndAmount	<IntrBkSttlmAmt></IntrBkSttlmAmt>
Value date	<IntrBkSttlmDt></IntrBkSttlmDt>
PaymentMethod	<PmtMtd>
Choice	xorFINMTPrtry
FIN Message Type	<FINMT></FINMT>
ProprietaryPaymentOriginType	<Prtry></Prtry>
End of Choice	/xorFINMTPrtry
End Payment Method	</PmtMtd>
Instructing Agent	<InstgAgt>
Financial Institution Identification	<FinInstnId>
BICFIIdentifier	<BICFI></BICFI>
End of Financial Institution Identification	</FinInstnId>
End of Instructing Agent	</InstgAgt>
Instructed Agent	<InstdAgt>
Financial Institution Identification	<FinInstnId>
BICFIIdentifier	<BICFI></BICFI>
End of Financial Institution Identification	</FinInstnId>
End of Instructed Agent	</InstdAgt>
EndToEndIdentification	<EndToEndId></EndToEndId>
End LongBusinessIdentification	</LngBizId>
ProprietaryId	<PrtryId></PrtryId>
End of choice	/xorLngBizIdPrtryId
End of InstructionReference	</InstrRef>
NewPaymentValueSet	<NewPmtValSet>
ProprietaryCode	<PrtryCd></PrtryCd>

End NewPaymentValueSet				</NewPmtValSet>
End of SSP Proprietary Data				</SspPrtryDt>
End of Proprietary Data				</Data>
End of Proprietary Data				</PrtryData>
End proprietary message				</PrtryMsg>

Attributes:

name of attribute	format	short description	description
<PrtryMsg>		Name Proprietary message Mandatory A2A	Validation:
<MsgHdr>		Message Header Mandatory A2A	Set of characteristics specific to the message Message Reference Validation: [1..1]
<MsgId>-</MsgId>	35x	Message Identification Mandatory A2A	Message Identification Validation: [1..1]
</MsgHdr>		End of Message Header Mandatory A2A	Validation: [1..1]
<PrtryData>		Proprietary Data Mandatory A2A	Proprietary Data Validation: [1..1]
<Tp>-</Tp>		Proprietary Data type Mandatory A2A	Proprietary Data type Validation: [1..1]
<Data>		Proprietary Data Mandatory	Proprietary data content Validation: [1..1]
<SspPrtryDt>		SSP Proprietary Data Mandatory A2A	SSP Proprietary Data Validation: [1..1]
<InstrRef>		InstructionReference Mandatory A2A	InstructionReference unique and unambiguous identification of a payment Validation: [1..1]
xorLngBizIdPrtryId		Choice Mandatory	PaymentIdentificationChoice: Choice between <LngBizId> and <PrtryId> Validation:
<LngBizId>		LongBusinessIdentification Mandatory	Identifies a payment instruction by a set of characteristics which provides an unambiguous identification of the instruction. TransactionIdentification InterBankSettlementAmount InterBankSettlementDate PaymentMethod InstructingAgent InstructedAgent EndToEndIdentification Validation: [1..1]

name of attribute	format	short description	description
<TxId>-</TxId>	16x	TransactionIdentification 16x	Unique and unambiguous identification of a payment transaction, as assigned by the originator. The payment transaction reference is used for reconciliation or to link tasks relating to the payment transaction. Mandatory Validation: [1..1]
<IntrBkSttlmAmt>-</IntrBkSttlmAmt>		ImpliedCurrencyAndAmount	ImpliedCurrencyAndAmount Mandatory Validation: [1..1]
<IntrBkSttlmDt>-</IntrBkSttlmDt>	ISODate	Value date	Value date Mandatory Validation: [1..1]
<PmtMtd>		PaymentMethod	PaymentMethod Mandatory Validation: [1..1]
xorFINMTPtry		Choice	Choice amongst <FINMT> and <Prtry> Mandatory Validation:
<FINMT>-</FINMT>	3x	FIN Message Type	103 202 204 Mandatory Validation: [1..1]
<Prtry>-</Prtry>	6c	ProprietaryPaymentOriginType	ASXML = Bookings stemming from incoming AS XML payments T2SXML = Bookings stemming from incoming T2S XML payments T2SXML = Bookings stemming from incoming TIPS XML payments INTERN = Bookings stemming from internal messages ORDER = Bookings stemming from current orders sent via ICM Mandatory Validation: [1..1]
/xorFINMTPtry		End of Choice	Mandatory Validation:
</PmtMtd>		End Payment Method	Mandatory Validation: [1..1]
<InstgAgt>		Instructing Agent	Instructing Agent Mandatory Validation: [1..1]
<FinInstnId>		Financial Institution Identification	Financial Institution Identification Mandatory Validation: [1..1]
<BICFI>-</BICFI>	4!a2!a2!c3!c	BICFIIdentifier	BICFIIdentifier - Sender

name of attribute	format	short description	description
		Mandatory	- FirstAgent BIC in case of AS XML payments Validation: [1..1]
</FinInstnId>		End of Financial Institution Identification Mandatory	End of Financial Institution Identification Validation: [1..1]
</InstgAgt>		End of Instructing Agent Mandatory	End of Instructing Agent Validation: [1..1]
<InstdAgt>		Instructed Agent Mandatory	Instructed Agent Validation: [1..1]
<FinInstnId>		Financial Institution Identification Mandatory	Financial Institution Identification Validation: [1..1]
<BICFI>-</BICFI>	4!a2!a2!c3!c	BICFIIdentifier Mandatory	BICFIIdentifier - Receiver - FinalAgent BIC in case of AS XML payments Validation: [1..1]
</FinInstnId>		End of Financial Institution Identification Mandatory	End of Financial Institution Identification Validation: [1..1]
</InstdAgt>		End of Instructed Agent Mandatory	End of Instructed Agent Validation: [1..1]
<EndToEndId>-</EndToEndId>	16x	EndToEndIdentification Optional	Unique and unambiguous identification of a payment transaction, as assigned by any of the parties on the initiating side, that will be passed on throughout the entire end-to-end chain Validation: [0..1]
</LngBizId>		End LongBusinessIdentification Mandatory	End LongBusinessIdentification Validation: [1..1]
<PrtryId>-</PrtryId>	16n	ProprietaryId Mandatory A2A	ProprietaryId SSP Booking ID (generated by PM; unique and unambiguous identifier of a booking) SSP Booking ID is delivered within ReturnTransaction message. Validation: [1..1]
/xorLngBizIdPrtryId		End of choice Mandatory	End of PaymentIdentificationChoice Validation:

name of attribute	format	short description	description
</InstrRef>		End of InstructionReference	End of InstructionReference
		Mandatory	Validation:
		A2A	[1..1]
<NewPmtValSet>		NewPaymentValueSet	Instruction to pay an amount of money to an ultimate beneficiary, on behalf of an originator. This instruction may have to be forwarded several times to complete the settlement chain.
			Instruction [0..1] PaymentType [0..1] Priority [0..1] ProcessingValidityTime [0..1]
		Mandatory	Validation:
		A2A	[1..1] Specifies if the payment is agreed or disagreed for further processing. AGRE = Agree; DISA = Disagree
<PrtryCd>-</PrtryCd>		ProprietaryCode	ProprietaryCode
			Specifies, if the payment is agreed or disagreed for further processing.
			AGRE = Agree DISA = Disagree
		Mandatory	Validation:
		A2A	[1..1] Agree or Disagree are only possible, if the status of payment is "Accounting Stopped due to exclusion" and the value date is the current business day.
</NewPmtValSet>		End NewPaymentValueSet	End of NewPaymentValueSet
		Mandatory	Validation:
		A2A	[1..1]
</SspPrtryDt>		End of SSP Proprietary Data	End of Root element for all SSP proprietary data
		Mandatory	Validation:
		A2A	[1..1]
</Data>		End of Proprietary Data	
		Mandatory	Validation:
			[1..1]
</PrtryData>		End of Proprietary Data	End of Proprietary Data
		Mandatory	Validation:
		A2A	[1..1]
</PrtryMsg>		End proprietary message	
		Mandatory	Validation:
		A2A	

Error Codes:

Order	Error code				Error Text / Validation/ Remark
	SSP	Y-copy	V-shape	XML	
1	X00			0000	Error Text: O.k. Validation: Confirmation, that a task is stored in the task queue. A related reference for the subsequent processing (e.g. confirmation) of the task is returned. Remark: Receipt (status code)
2	X44			1404	Error Text: If "non repudiation of emission" is mandatory, the NRE indicator flag has to be present Validation: If non-repudiaton processing is mandatory, the tag <SwInt:NRIndicator>TRUE</SwInt:NRIndicator> has to be present. Remark: checked by ICM / Receipt
3	X41			1401	Error Text: No permission. RBAC User role(s) are not sufficient. Validation: Message is allowed for central banks only. RBAC role name APPLICBTE is required Remark: checked by ICM / Receipt
4	P98			P098	Error Text: Only the Central Bank of the excluded Settlement Bank or of the excluded Ancillary System can agree or disagree on this payment. Validation: PrtryRef value must indicate a transaction crediting or debiting the account of an excluded participant or a transaction crediting or debiting the mirror account used by an excluded Ancillary System the requesting Central Bank is responsible for. Remark: checked by ICM / Receipt
7	862	C2	TM01	2862	Error Text: Request out of cut-off time Validation: Possibility to use this function during the current phase of business day. Remark: checked by PM / TaskQueue
8	P87			P117	Error Text: Only responsible Central Banks can agree or disagree to the settlement. Validation: instructing central bank belongs to an excluded Participant Remark: TaskQueue
9	P88			P118	Error Text: Function is only possible, if the status of payment/file is "accounting stopped due to exclusion" and the value date is the current business day. Validation: Agree, Disagree are only possible, if the status of payment is "Stopped due to exclusion" and value date is the current business day. Remark: TaskQueue
10	P13			P013	Error Text: No payment found Validation: PrtryRef does exist Remark: TaskQueue
11	P13			P013	Error Text: No payment found Validation: there has to be a payment which can be agreed/disagreed Remark: TaskQueue
12	866	C6	AC06	2866	Error Text: Exclusion of participant Validation: If requestor is direct participant or ancillary system or GoA manager and this requestor is excluded, no change of data is allowed Remark: TaskQueue

ReleasePayment_PM_2

Scope: Disagree Payment for further processing.

Name Proprietary message	<PrtryMsg>
Message Header	<MsgHdr>
Message Identification	<MsgId>ABC123</MsgId>
End of Message Header	</MsgHdr>
Proprietary Data	<PrtryData>
Proprietary Data type	<Tp>ReleasePayment</Tp>
Proprietary Data	<Data>
SSP Proprietary Data	<SspPrtryDt>
InstructionReference	<InstrRef>
ProprietaryId	<PrtryId>123</PrtryId>
End of InstructionReference	</InstrRef>
NewPaymentValueSet	<NewPmtValSet>
ProprietaryCode	<PrtryCd>DISA</PrtryCd>
End NewPaymentValueSet	</NewPmtValSet>
End of SSP Proprietary Data	</SspPrtryDt>
End of Proprietary Data	</Data>
End of Proprietary Data	</PrtryData>
End proprietary message	</PrtryMsg>

ReleasePayment_PM_3

Scope: Disagree Payment for further processing. Payment is identified via LngBizId

Name Proprietary message	<PrtryMsg>
Message Header	<MsgHdr>
Message Identification	<MsgId>ABC123</MsgId>
End of Message Header	</MsgHdr>
Proprietary Data	<PrtryData>
Proprietary Data type	<Tp>ReleasePayment</Tp>
Proprietary Data	<Data>
SSP Proprietary Data	<SspPrtryDt>
InstructionReference	<InstrRef>
LongBusinessIdentification	<LngBizId>
TransactionIdentification 16x	<TxId>Trans001</TxId>
ImpliedCurrencyAndAmount	<IntrBkSttlmAmt>500.00</IntrBkSttlmAmt>
Value date	<IntrBkSttlmDt>2015-09-01</IntrBkSttlmDt>
PaymentMethod	<PmtMtd>
FIN Message Type	<FINMT>202</FINMT>
End Payment Method	</PmtMtd>
Instructing Agent	<InstgAgt>
Financial Institution Identification	<FinInstnId>
BICFIIdentifier	<BICFI>DRESDEFFXXX</BICFI>
End of Financial Institution Identification	</FinInstnId>
End of Instructing Agent	</InstgAgt>
Instructed Agent	<InstdAgt>
Financial Institution Identification	<FinInstnId>
BICFIIdentifier	<BICFI>DEUTDEFFXXX</BICFI>
End of Financial Institution Identification	</FinInstnId>
End of Instructed Agent	</InstdAgt>
End LongBusinessIdentification	</LngBizId>
End of InstructionReference	</InstrRef>
NewPaymentValueSet	<NewPmtValSet>
ProprietaryCode	<PrtryCd>DISA</PrtryCd>
End NewPaymentValueSet	</NewPmtValSet>
End of SSP Proprietary Data	</SspPrtryDt>
End of Proprietary Data	</Data>
End of Proprietary Data	</PrtryData>
End proprietary message	</PrtryMsg>

6. 4.21 ReturnAccount

Cash Management Standard

ReturnAccount _PM

Scope: The ReturnAccount message is used to return information about the
 - balance on the following accounts kept in PM
 - RTGS account.
 - sub-account.

The connected request is performed by a GetAccount message.

<camt.004.001.xx>

Structure:

Message Type	<RtrAcct>
Message Header	<MsgHdr>
Message Identification	<MsgId></MsgId>
Original Business Query	<OrgnlBizQry>
Message Identification	<MsgId></MsgId>
End of Original Business Query	</OrgnlBizQry>
End of Message Header	</MsgHdr>
AccountOrOperationalErrorChoice	<RptOrErr>
Choice	xorAcctOprlErr
AccountReport	<AcctRpt>
Account Identification	<AcctId>
GenericAccountIdentification	<Othr>
Identification	<Id></Id>
End of GenericAccountIdentification	</Othr>
End of Account Identification	</AcctId>
Choice	xorAcctBizErr
Account Identification	<Acct>
CashAccountType	<Tp>
CashAccountTypeCode	<Cd></Cd>
End of CashAccountType	</Tp>
Owner	<Ownr>
Identification	<Id>
OrganisationIdentification	<OrgId>
AnyBICIdentifier	<AnyBIC></AnyBIC>
End of OrganisationIdentification	</OrgId>
End Identification	</Id>
End of Owner	</Ownr>
MultilateralBalance	<MulBal>
Amount	<Amt></Amt>
Credit or debit indicator	<CdtDbtInd></CdtDbtInd>
Balance Type choice	<Tp>
BalanceTypeCode	<Cd></Cd>
End balance type choice	</Tp>
BalanceStatusCode	<Sts></Sts>
End of MultilateralBalance	</MulBal>
End of Account	</Acct>
End of choice	/xorAcctBizErr
End of AccountReport	</AcctRpt>
OperationalError	<OprlErr>
Error handling	<Err>
Proprietary error code	<Prtry></Prtry>

End error handling	</Err>
Description	<Desc></Desc>
End of Operational Error	</OpriErr>
End of choice	/xorRptOpriErr
End of AccountOrOperationalErrorChoice	</RptOrErr>
End of Message Type	</RtrAcct>

Attributes:

name of attribute	format	short description	description
<RtrAcct>		Message Type Mandatory A2A	Validation:
<MsgHdr>		Message Header Mandatory A2A	Set of characteristics specific to the message Validation: [1..1]
<MsgId>-</MsgId>	35x	Message Identification Mandatory A2A	Message Identification Validation: [1..1]
<OrgnlBizQry>		Original Business Query Mandatory A2A	Original Business Query, reference to the query Validation: *****[1..1] In PM mandatory differs from the cash management standard
<MsgId>-</MsgId>	35x	Message Identification Mandatory A2A	Message Identification Validation: [1..1]
</OrgnlBizQry>		End of Original Business Query Mandatory A2A	End of Original Business Query, reference to the query Validation: [1..1]
</MsgHdr>		End of Message Header Mandatory A2A	Validation: [1..1]
<RptOrErr>		AccountOrOperationalError Choice Mandatory	Validation:
xorRptOprlErr		Choice Mandatory A2A	Validation: [1..1]
<AcctRpt>		AccountReport Mandatory A2A	Validation: *****[1..1] differs from the cash management standard
<AcctId>		Account Identification Mandatory A2A	Unique and unambiguous identification for the account between the account owner and the account servicer. Validation: [1..1]
<Othr>		GenericAccountIdentification Mandatory A2A	GenericAccountIdentification Validation: [1..1]
<Id>-</Id>	34x	Identification	Name or number assigned by an entity to enable recognition of that entity, eg, account identifier. RTGS main account / sub-account

name of attribute	format	short description	description
		Mandatory A2A	Validation: [1..1] RTGS account 34x
</Othr>		End of GenericAccountIdentification Mandatory A2A	End of GenericAccountIdentification Validation: [1..1]
</AcctId>		End of Account Identification Mandatory A2A	Unique and unambiguous identification for the account between the account owner and the account servicer. Validation: [1..1]
xorAcctBizErr		Choice Mandatory	Validation: [1..1]
<Acct>		Account Identification Mandatory A2A	Account to or from which a cash entry is made Validation: [1..1] BusinessError is not used
<Tp>		CashAccountType Mandatory A2A	CashAccountType Validation: [1..1] in PM only SACC = Settlement account is used
<Cd>-</Cd>	4!c	CashAccountTypeCode Mandatory	Supported codes: CASH = T2S Dedicated Cash Account SACC = TARGET2 RTGS Account Validation: [1..1]
</Tp>		End of CashAccountType Mandatory	End of CashAccountType Validation: [1..1]
<Ownr>		Owner Mandatory A2A	BIC of the RTGS main Account (SSP Participant or BIC in the case on behalf of third party) Validation: [1..1]
<Id>		Identification Mandatory	Validation: [1..1]
<OrgId>		OrganisationIdentification Mandatory	OrganisationIdentification Validation: [1..1]
<AnyBIC>-</AnyBIC>	4!a2!a2!c[3!cAnyBICIdentifier]	Mandatory	Validation: [1..1]
</OrgId>		End of OrganisationIdentification	End of OrganisationIdentification

name of attribute	format	short description	description
		Mandatory	Validation: [1..1]
</ld>		End Identification	End Identification
		Mandatory	Validation: [1..1]
</Ownr>		End of Owner	
		Mandatory	Validation: [1..1]
<MulBal>		MultilateralBalance	Balance is calculated with regard to many members in the system.
		Optional	Validation: ****[0..12]differs from th cash management standard in PM NbOfPmts is not used
		A2A	
<Amt>		Amount	
		Mandatory	Validation: [1..1] in PM only 2 fraction digits are possible
		A2A	
<CdtDbtInd>-</CdtDbtInd>	4!a	Credit or debit indicator	CRDT = Credit Operation is an increase. DBIT = Debit Operation is a decrease. Indicates whether the balance is a credit or a debit balance. A zero balance can be a credit or a debit. Values : "CRDT", "DBIT" In the case of BalanceTypeCode NOTE it defines wheter it is a earmarked payment for Debits or Credits
		Mandatory	Validation: [1..1]
		A2A	
<Tp>		Balance Type choice	
		Mandatory	Validation: ****[1..1] differs from the cash management standard In PM mandatory.
		A2A	
<Cd>		BalanceTypeCode	Specifies the nature of the balance, eg, opening balance. ADJT= Adjustment Average balance to be held in the settlement account at the end of each day in order to fulfil the reserve due. The approximation will be always made rounding up. AVLB = Available Balance of money or securities that is at the disposal of the account owner on the date specified. BLCK = Blocked Balance representing the regulatory reserve that a financial institution must have with the account servicing institution, eg, the minimum credit balance a financial institution is to keep with ist Central Bank for mandatory reserve purposes. In some countries, a blocked balance is known as a 'reserve' balance. BOOK = Book Balance that is registered in the books of the account servicer. CLSG = Closing Balance of the account at the end of the account servicer's business day. It is the sum of the opening balance at the beginning of the day and all entries booked to the account during the account servicer's business day.

name of attribute	format	short description	description
			<p>CRDT = Credit Balance representing the sum of all credit entries booked to an account.</p> <p>CRRT = Current Balance of the account at a precise moment in time.</p> <p>DBIT = Debit Balance representing the sum of all debit entries booked to an account.</p> <p>DLOD = DaylightOverdraft Balance representing the intra day overdraft granted by the Central Bank to financial institutions participating in a RTGS system. This balance may vary over time and shall be offset at the end of the day.</p> <p>EAST = EligibleAssets Balance representing the potential loan a Central Bank would make in cash if the collateral is pledged, eg, securities available and eligible as collateral with the Central Bank.</p> <p>INTM = Interim Balance calculated in the course of the account servicer's business day, at the time specified, and subject to further changes during the business day. The interim balance is calculated on the basis of booked credit and debit items during the calculation time/period specified.</p> <p>LRLD = LimitRelated Balance of a specific limit value, eg, a bilateral balance is calculated in relation to a given bilateral limit.</p> <p>LTSF= LiquidityTransfer Balance composed of the sum of all liquidity transfers made to or from an account.</p> <p>OPNG = Opening Book balance of the account at the beginning of the account servicer's business day. It always equals the closing book balance from the previous business day. Note: the available balance at the beginning of the account servicer's business day may be different from the closing book balance from the previous business day.</p> <p>PDNG = Pending Balance of securities pending delivery, eg, orders to sell securities have been executed but settlement of the open transactions has not been confirmed.</p> <p>PRAV = ProgressiveAverage Average of the daily balances on the account used to fulfil the reserve requirements calculated from the beginning of the maintenance period.</p> <p>PYMT = Payment Balance representing the sum of entries as a result of payments processing. Entries relating to fees, interest, or other movements not a result of payments sent or received by the account owner are not included.</p> <p>XCRD = ExpectedCredit Balance, composed of booked entries and pending items known at the time of calculation, which projects the end of day credit balance if everything books to the account and no other credit entry is posted.</p> <p>XDBT = ExpectedDebit Balance, composed of booked entries and pending items known at the time of calculation, which projects the end of day debit balance if everything books to the account and no other debit entry is posted.</p> <p>XPCD = Expected Balance, composed of booked entries and pending items known at the time of calculation, which projects the end of day balance if everything is booked on the</p>

name of attribute	format	short description	description
			account and no other entry is posted.
			*****NOTE = Noted Balance Balance representing the amount that a financial institution has set aside for a specific reason and which is therefore not available
		Mandatory	Validation:
		A2A	[1..1]Following Codes in PM are possible: AVLB = available liquidity OPNG = start Balance NOTE = earmarked payments CRDT = credits CRRT = current balance DBIT = debits LTSF = Liquidity Transfer XPCD = projected liquidity
</Tp>		End balance type choice	
		Mandatory	Validation:
		A2A	*****[1..1]
<Sts>		BalanceStatusCode	Current status of a cash balance.
			PDNG = Pending Balance corresponding to the pending transactions.
			STLD = Settled Final status of a transaction when the associated transfer of cash has been successfully processed.
		Mandatory	Validation:
		A2A	*****[1..1] in PM mandatory differs from the cash management standard AVLB = available liquidity (only STLD is possible) OPNG = start Balance (only STLD is possible) NOTE = timed payments (only PDNG is possible) CRDT = credits CRRT = current balance (only STLD is possible) DBIT = debits LTSF = Liquidity Transfer XPCD = projected liquidity (only PDNG is possible)
</MulBal>		End of MultilateralBalance	End of MultilateralBalance
		Optional	Validation:
		A2A	[0..11]
</Acct>		End of Account	End of Account
		Mandatory	Validation:
		A2A	[1..1]
/xorAcctBizErr		End of choice	
		Mandatory	Validation:
			[1..1]
</AcctRpt>		End of AccountReport	End of AccountReport
		Mandatory	Validation:
		A2A	[1..1]
<OprlErr>		OperationalError	Rule rationale: The message will contain either the information matching the search criteria of the related Get message or an error indication.
			Rule description: If BusinessReport is present then OperationalError is not allowed. If BusinessReport is not present, then OperationalError is mandatory.

name of attribute	format	short description	description
			Separate Specification see UDFS books regarding error codes
		Mandatory A2A	Validation: *****[1..1]
<Err>		Error handling Mandatory A2A	Validation: [1..1]
<Prtry>-</Prtry>	4x	Proprietary error code Mandatory A2A	Specification of the error, in free format. Validation: [1..1]
</Err>		End error handling Mandatory A2A	Validation: [1..1]
<Desc>-</Desc>	140x	Description Optional A2A	Specification of the error, in free format. Validation: [0..1]
</OpriErr>		End of Operational Error Mandatory A2A	End of Operational Error Validation: *****[1..1]
/xorRptOpriErr		End of choice Mandatory A2A	Validation: [1..1]
</RptOrErr>		End of AccountOrOperationalError Choice Optional	Validation:
</RtrAcct>		End of Message Type Mandatory A2A	Validation:

Error Codes:

ReturnAccount_PM_1

Scope: ReturnAccount: response to a RTGS main account, with all possible balance types.

Message Type	<RtrAcct>
Message Header	<MsgHdr>
Message Identification	<MsgId>ABCD1234569</MsgId>
Original Business Query	<OrgnlBizQry>
Message Identification	<MsgId>ABC17282991</MsgId>
End of Original Business Query	</OrgnlBizQry>
End of Message Header	</MsgHdr>
AccountOrOperationalErrorChoice	<RptOrErr>
Choice	xorRptOprlErr
AccountReport	<AcctRpt>
Account Identification	<AcctId>
GenericAccountIdentification	<Othr>
Identification	<Id>BE67123456789122345678</Id>
End of GenericAccountIdentification	</DmstAcct>
End of Account Identification	</AcctId>
Choice	xorAcctBizErr
Account Identification	<Acct>
CashAccountType	<Tp>
CashAccountTypeCode	<Cd>SACC</Cd>
End of CashAccountType	</Tp>
Owner	<Ownr>
Identification	<Id>
OrganisationIdentification	<OrgId>
AnyBICIdentifier	<AnyBIC>DEUTDEFFXXX</AnyBIC>
End of OrganisationIdentification	</OrgId>
End Identification	</Id>
End of Owner	</Ownr>
MultilateralBalance	<MulBal>
Amount	<Amt>222000000.00</Amt>
Credit or debit indicator	<CdtDbtInd>CRDT</CdtDbtInd>
Balance Type choice	<Tp>
BalanceTypeCode	<Cd>OPNG</Cd>
End balance type choice	</Tp>
BalanceStatusCode	<Sts>STLD</Sts>
End of MultilateralBalance	</MulBal>
MultilateralBalance	<MulBal>
Amount	<Amt>28000000.00</Amt>
Credit or debit indicator	<CdtDbtInd>CRDT</CdtDbtInd>
Balance Type choice	<Tp>
BalanceTypeCode	<Cd>LTSF</Cd>
End balance type choice	</Tp>
BalanceStatusCode	<Sts>STLD</Sts>
End of MultilateralBalance	</MulBal>
MultilateralBalance	<MulBal>
Amount	<Amt>27300000.00</Amt>
Credit or debit indicator	<CdtDbtInd>DBIT</CdtDbtInd>
Balance Type choice	<Tp>
BalanceTypeCode	<Cd>DBIT</Cd>
End balance type choice	</Tp>

BalanceStatusCode	<Sts>STLD</Sts>
End of MultilateralBalance	</MulBal>
MultilateralBalance	<MulBal>
Amount	<Amt>40000000.00</Amt>
Balance Type choice	<Tp>
BalanceTypeCode	<Cd>DBIT</Cd>
End balance type choice	</Tp>
BalanceStatusCode	<Sts>PDNG</Sts>
End of MultilateralBalance	</MulBal>
MultilateralBalance	<MulBal>
Amount	<Amt>77300000.00</Amt>
Balance Type choice	<Tp>
BalanceTypeCode	<Cd>CRDT</Cd>
End balance type choice	</Tp>
BalanceStatusCode	<Sts>STLD</Sts>
End of MultilateralBalance	</MulBal>
MultilateralBalance	<MulBal>
Amount	<Amt>22000000.00</Amt>
Balance Type choice	<Tp>
BalanceTypeCode	<Cd>CRDT</Cd>
End balance type choice	</Tp>
BalanceStatusCode	<Sts>PDNG</Sts>
End of MultilateralBalance	</MulBal>
MultilateralBalance	<MulBal>
Amount	<Amt>300000000.00</Amt>
Balance Type choice	<Tp>
BalanceTypeCode	<Cd>CRRT</Cd>
End balance type choice	</Tp>
BalanceStatusCode	<Sts>STLD</Sts>
End of MultilateralBalance	</MulBal>
MultilateralBalance	<MulBal>
Amount	<Amt>320000000.00</Amt>
Balance Type choice	<Tp>
BalanceTypeCode	<Cd>AVLB</Cd>
End balance type choice	</Tp>
BalanceStatusCode	<Sts>STLD</Sts>
End of MultilateralBalance	</MulBal>
MultilateralBalance	<MulBal>
Amount	<Amt>304000000.00</Amt>
Balance Type choice	<Tp>
BalanceTypeCode	<Cd>XPCD</Cd>
End balance type choice	</Tp>
BalanceStatusCode	<Sts>PDNG</Sts>
End of MultilateralBalance	</MulBal>
MultilateralBalance	<MulBal>
Amount	<Amt>10000000.00</Amt>
Balance Type choice	<Tp>
BalanceTypeCode	<Cd>NOTE</Cd>
End balance type choice	</Tp>
BalanceStatusCode	<Sts>PDNG</Sts>
End of MultilateralBalance	</MulBal>
MultilateralBalance	<MulBal>

Amount		<Amt>15500000.00</Amt>
Credit or debit indicator		<CdtDbtInd>CRDT</CdtDbtInd>
Balance Type choice		<Tp>
BalanceTypeCode		<Cd>NOTE</Cd>
End balance type choice		</Tp>
BalanceStatusCode		<Sts>PDNG</Sts>
End of MultilateralBalance		</MulBal>
End of Account		</Acct>
End of choice		/xorAcctBizErr
End of AccountReport		</AcctRpt>
End of choice		</BizRpt>
End of AccountOrOperationalErrorChoice		</RptOrErr>
End of Message Type		</RtrAcct>

6. 4.22 ReturnBusinessDayInformation

Cash Management Standard

ReturnBusinessDayInformation_PM

Scope: The ReturnBusinessDayInformation message is used to return SSP event times of the current operating day.

The connected request is performed by a GetBusinessDayInformation message.

<camt.019.001.xx>

Structure:

MessageName ReturnBusinessDayInformation	<RtrBizDayInf>
Message Header	<MsgHdr>
Message Identification	<MsgId></MsgId>
Original Business Query	<OrgnlBizQry>
Message Identification	<MsgId></MsgId>
End of Original Business Query	</OrgnlBizQry>
End of Message Header	</MsgHdr>
BusinessDayReportOrErrorChoice	<RptOrErr>
choice	xorOprlErrBizRpt
OperationalError	<OprlErr>
Error handling	<Err>
Proprietary error code	<Prtry></Prtry>
End error handling	</Err>
Description	<Desc></Desc>
End of Operational Error	</OprlErr>
BusinessReport	<BizRpt>
SystemIdentification	<SysId>
MarketInfrastructureIdentification	<MktInfrstrctId>
ExternalMarketInfrastructureCode	<Cd></Cd>
End of MarketInfrastructureIdentification	</MktInfrstrctId>
End of SystemIdentification	</SysId>
BusinessDayReportOrErrorChoice	<BizDayOrErr>
BusinessDayInformation	<BizDayInf>
SystemInformationPerCurrency	<SysInfPerCcy>
SystemCurrency	<SysCcy></SysCcy>
Event	<Evt>
BalanceTypeCode	<Tp>
GenericIdentification	<Prtry>
ProprietaryEventCode	<Id></Id>
End of GenericIdentification	</Prtry>
End of SystemEventTypeChoice	</Tp>
ScheduledTime	<SchldTm></SchldTm>
EffectiveTime	<FctvTm></FctvTm>
End of Event	</Evt>
End of SystemInformationPerCurrency	</SysInfPerCcy>
End of BusinessDayInformation	</BizDayInf>
End of BusinessDayReportOrErrorChoice	</BizDayOrErr>
End of BusinessReport	</BizRpt>
End of choice	/xorOprlErrBizRpt
End of BusinessDayReportOrErrorChoice	</RptOrErr>
End MessageName ReturnBusinessDayInformation	</RtrBizDayInf>

Attributes:

name of attribute	format	short description	description
<RtrBizDayInf>		MessageName ReturnBusinessDayInformation Mandatory A2A	MessageName ReturnBusinessDayInformation Validation:
<MsgHdr>		Message Header Mandatory A2A	Set of characteristics specific to the message Validation: [1..1]
<MsgId>-</MsgId>	35x	Message Identification Mandatory A2A	Message Identification Validation: [1..1]
<OrgnlBizQry>		Original Business Query Mandatory A2A	Original Business Query, reference to the query Validation: [1..1]
<MsgId>-</MsgId>	35x	Message Identification Mandatory A2A	Message Identification Validation: [1..1]
</OrgnlBizQry>		End of Original Business Query Mandatory A2A	End of Original Business Query, reference to the query Validation: [1..1]
</MsgHdr>		End of Message Header Mandatory A2A	 Validation: [1..1]
<RptOrErr>		BusinessDayReportOrError Choice Mandatory	 Validation: [1..1]
xorOprlErrBizRpt		choice Optional A2A	choice amongst <OprlErr> and <BizRpt> Validation:
<OprlErr>		OperationalError Mandatory A2A	Rule rationale: The message will contain either the information matching the search criteria of the related Get message or an error indication. Rule description: If BusinessReport is present then OperationalError is not allowed. If BusinessReport is not present, then OperationalError is mandatory. Separate Specification see UDFS books regarding error codes Validation: [1..1]
<Err>		Error handling Mandatory A2A	 Validation: [1..1]

name of attribute	format	short description	description
<Prtry>-</Prtry>	4x	Proprietary error code	Specification of the error, in free format.
		Mandatory	Validation: [1..1]
		A2A	
</Err>		End error handling	
		Mandatory	Validation: [1..1]
		A2A	
<Desc>-</Desc>	140x	Description	Specification of the error, in free format.
		Optional	Validation: [0..1]
		A2A	
</OpriErr>		End of Operational Error	End of Operational Error
		Mandatory	Validation: [1..1]
		A2A	
<BizRpt>		BusinessReport	BusinessReport
			Rule rationale: The message will contain either the information matching the search criteria of the related Get message or an error indication.
			Rule description: If BusinessReport is present then OperationalError is not allowed. If BusinessReport is not present, then OperationalError is mandatory.
		Mandatory	Validation: [1..1]
		A2A	
<SysId>		SystemIdentification	Identification of a particular cash clearing system.
		Mandatory	Validation: [1..1]differs from the cash management standard
		A2A	
<MktInfrstrctrlId>		MarketInfrastructureIdentification	used for the current information about the status of the SSP operating day
		Mandatory	Validation: [1..1] only TGT = Clearing Code for SSP is used
		A2A	
<Cd>-</Cd>		ExternalMarketInfrastructureCode	
		Mandatory	Validation: [1..1]
</MktInfrstrctrlId>		End of MarketInfrastructureIdentification	
		Mandatory	Validation: [1..1]
</SysId>		End of SystemIdentification	End of SystemIdentificationChoice
		Mandatory	Validation: [1..1]
		A2A	
<BizDayOrErr>		BusinessDayReportOrErrorChoice	
		Mandatory	Validation: [1..1]differs from the cash management standard
		A2A	

name of attribute	format	short description	description
<BizDayInf>		BusinessDayInformation	The requested business information.
		Mandatory A2A	Validation: [1..1] BusinessError is not used
<SysInfPerCcy>		SystemInformationPerCurrency	Information relating to system operations and foreseen events relating to the operation of the system. Set of integrated applications that provides centralised services such as clearing, netting, reconciliation, trading and/or settlement.
		Optional A2A	Validation: [1..1]differs from the cash management standard
<SysCcy>		SystemCurrency	SystemCurrency Currency which may be processed by the system. A system may process transactions in a single currency or in multiple currencies. Code allocated to a currency, by a maintenance agency, under an international identification scheme as described in the latest edition of the international standard ISO 4217 "Codes for the representation of currencies and funds". Valid currency codes are registered with the ISO 4217 Maintenance Agency, and consist of three contiguous letters. Standard EUR
		Mandatory A2A	Validation: [1..1] only EUR possible
<Evt>		Event	Detailed information about an event occurring on a system, whether planned, eg, cut-off time for a specific type of eligible transfer, or unplanned, eg, an unsolicited failure, as stipulated in the specifications of the system.
		Mandatory A2A	Validation: [1..14]
<Tp>		BalanceTypeCode	Nature of the event that has occurred.
		Mandatory A2A	Validation: [1..1] only PrtryEvt is used
<Prtry>		GenericIdentification	
		Mandatory A2A	Validation: [1..1]
<Id></Id>		ProprietaryEventCode	Common SSP-events
		Mandatory	Validation: [1..1]STOD = Start of Day STOL = Start of Provisioning of Liquidity SOAS = Start of Setting aside Liquidity and settlement of AS overnight business SSCL = SSP closed CSAS = Continuing of Setting aside Liquidity and Settlement of AS overnight business STBW = Start of Business Window to prepare daylight Operation STDT = Start of DayTrade Phase COCP = Cut-off customer payments COCR = Cut-off for Cash Reservation COBP = Cut-off for Bank to Bank Payments SEOD = Start of end of day processing (in case the effective event time will be displayed, the SchldTm and FctvTm will include the same time indication) COMI = Cut-Off for Message Input COSF = Cut-off for use of standing facilities

name of attribute	format	short description	description
			COTS = Cut-off for T2S business (only if switch for T2S functionality = on)
</Prtry>		End of GenericIdentification Mandatory	Validation: [1..1]
</Tp>		End of SystemEventTypeChoice Mandatory A2A	Validation: [1..1]
<SchlddTm>-</SchlddTm>	ISODateTime	ScheduledTime Mandatory A2A	Date and time at which the event is foreseen to occur. standard Times of the common SSP-events Validation: [1..1]
<FctvTm>-</FctvTm>	ISODateTime	EffectiveTime Optional A2A	Date and time at which the event effectively takes place. current business day, displays the real time when the event took place Validation: [0..1] only displayed if the requestor is a CB user. Information of the current business day the "real time" when the event took place.
</Evt>		End of Event Mandatory A2A	End of detailed information about an event occurring on a system, whether planned, eg, cut-off time for a specific type of eligible transfer, or unplanned, eg, an unsolicited failure, as stipulated in the specifications of the system. Validation: [1..14]
</SysInfPerCcy>		End of SystemInformationPerCurrency Optional A2A	End of SystemInformationPerCurrency Validation: [0..1]
</BizDayInf>		End of BusinessDayInformation Mandatory A2A	End of BusinessDayInformation Validation: [1..1]
</BizDayOrErr>		End of BusinessDayReportOrErrorChoice Mandatory A2A	Validation: [1..1]
</BizRpt>		End of BusinessReport Mandatory A2A	End of BusinessReport Validation: [1..1]
/xorOprlErrBizRpt		End of choice Mandatory A2A	end of choice amongst <OprlErr> and <BizRpt> Validation:
</RptOrErr>		End of BusinessDayReportOrErrorChoice Mandatory	Validation: [1..1]

name of attribute	format	short description	description
</RtrBizDayInf>		End Messagename ReturnBusinessDayInforma tion Mandatory A2A	Validation:

Error Codes:

ReturnBusinessDayInformation_PM_1

Scope: ReturnBusinessDayInformation response to non CB users: Information about the scheduled event times of current SSP Operating day.

MessageName ReturnBusinessDayInformation	<RtrBizDayInf>
Message Header	<MsgHdr>
Message Identification	<MsgId>ABCDEFGHIJKLMNQRST123456789012345</MsgId>
Original Business Query	<OrgnlBizQry>
Message Identification	<MsgId>ABC123465</MsgId>
End of Original Business Query	</OrgnlBizQry>
End of Message Header	</MsgHdr>
BusinessDayReportOrErrorChoice	<RptOrErr>
BusinessReport	<BizRpt>
SystemIdentification	<SysId>
MarketInfrastructureIdentification	<MktInfrstrctrlId>
ExternalMarketInfrastructureCode	<Cd>TGT</Cd>
End of MarketInfrastructureIdentification	</MktInfrstrctrlId>
End of SystemIdentification	</SysId>
BusinessDayReportOrErrorChoice	<BizDayOrErr>
BusinessDayInformation	<BizDayInf>
SystemInformationPerCurrency	<SysInfPerCcy>
SystemCurrency	<SysCcy>EUR</SysCcy>
Event	<Evt>
BalanceTypeCode	<Tp>
GenericIdentification	<Prtry>
ProprietaryEventCode	<Id>STOD</Id>
End of GenericIdentification	</Prtry>
End of SystemEventTypeChoice	</Tp>
ScheduledTime	<SchdldTm>2012-05-04T18:45:00</SchdldTm>
End of Event	</Evt>
Event	<Evt>
BalanceTypeCode	<Tp>
GenericIdentification	<Prtry>
ProprietaryEventCode	<Id>STOL</Id>
End of GenericIdentification	</Prtry>
End of SystemEventTypeChoice	</Tp>
ScheduledTime	<SchdldTm>2012-05-04T19:00:00</SchdldTm>
End of Event	</Evt>
Event	<Evt>
BalanceTypeCode	<Tp>
GenericIdentification	<Prtry>
ProprietaryEventCode	<Id>SOAS</Id>
End of GenericIdentification	</Prtry>
End of SystemEventTypeChoice	</Tp>
ScheduledTime	<SchdldTm>2012-05-04T19:30:00</SchdldTm>
End of Event	</Evt>
Event	<Evt>
BalanceTypeCode	<Tp>
GenericIdentification	<Prtry>
ProprietaryEventCode	<Id>SSCL</Id>
End of GenericIdentification	</Prtry>
End of SystemEventTypeChoice	</Tp>
ScheduledTime	<SchdldTm>2012-05-04T22:00:00</SchdldTm>

End of Event						</Evt>
Event						<Evt>
BalanceTypeCode						<Tp>
GenericIdentification						<Prtry>
ProprietaryEventCode						<Id>CSAS</Id>
End of GenericIdentification						</Prtry>
End of SystemEventTypeChoice						</Tp>
ScheduledTime						<SchlddTm>2012-05-05T05:00:00</SchlddTm>
End of Event						</Evt>
Event						<Evt>
BalanceTypeCode						<Tp>
GenericIdentification						<Prtry>
ProprietaryEventCode						<Id>STBW</Id>
End of GenericIdentification						</Prtry>
End of SystemEventTypeChoice						</Tp>
ScheduledTime						<SchlddTm>2012-05-05T06:45:00</SchlddTm>
End of Event						</Evt>
Event						</Evt>
BalanceTypeCode						<Tp>
GenericIdentification						<Prtry>
ProprietaryEventCode						<Id>STDT</Id>
End of GenericIdentification						</Prtry>
End of SystemEventTypeChoice						</Tp>
ScheduledTime						<SchlddTm>2012-05-05T07:00:00</SchlddTm>
End of Event						<Evt>
Event						<Evt>
BalanceTypeCode						<Tp>
GenericIdentification						<Prtry>
ProprietaryEventCode						<Id>COCP</Id>
End of GenericIdentification						</Prtry>
End of SystemEventTypeChoice						</Tp>
ScheduledTime						<SchlddTm>2012-05-05T17:00:00</SchlddTm>
End of Event						</Evt>
Event						<Evt>
BalanceTypeCode						<Tp>
GenericIdentification						<Prtry>
ProprietaryEventCode						<Id>COCR</Id>
End of GenericIdentification						</Prtry>
End of SystemEventTypeChoice						</Tp>
ScheduledTime						<SchlddTm>2012-05-05T17:07:30</SchlddTm>
End of Event						</Evt>
Event						<Evt>
BalanceTypeCode						<Tp>
GenericIdentification						<Prtry>
ProprietaryEventCode						<Id>COBP</Id>
End of GenericIdentification						</Prtry>
End of SystemEventTypeChoice						</Tp>
ScheduledTime						<SchlddTm>2012-05-05T18:00:0</SchlddTm>
End of Event						</Evt>
Event						<Evt>
BalanceTypeCode						<Tp>
GenericIdentification						<Prtry>

ProprietaryEventCode	<Id>SEOD</Id>
End of GenericIdentification	</Prtry>
End of SystemEventTypeChoice	</Tp>
ScheduledTime	<SchlddTm>2012-05-05T18:07:30</SchlddTm>
EffectiveTime	<FctvTm>2012-05-05T18:07:30</FctvTm>
End of Event	</Evt>
Event	<Evt>
BalanceTypeCode	<Tp>
GenericIdentification	<Prtry>
ProprietaryEventCode	<Id>COMI</Id>
End of GenericIdentification	</Prtry>
End of SystemEventTypeChoice	</Tp>
ScheduledTime	<SchlddTm>2012-05-05T17:10:00</SchlddTm>
End of Event	</Evt>
Event	<Evt>
BalanceTypeCode	<Tp>
GenericIdentification	<Prtry>
ProprietaryEventCode	<Id>COSF</Id>
End of GenericIdentification	</Prtry>
End of SystemEventTypeChoice	</Tp>
ScheduledTime	<SchlddTm>2012-05-05T17:25:00</SchlddTm>
End of Event	</Evt>
End of SystemInformationPerCurrency	</SysInfPerCcy>
End of BusinessDayInformation	</BizDayInf>
End of BusinessDayReportOrErrorChoice	</BizDayOrErr>
End of BusinessReport	</BizRpt>
End of BusinessDayReportOrErrorChoice	</RptOrErr>
End Messagename ReturnBusinessDayInformation	</RtrBizDayInf>

ReturnBusinessDayInformation_PM_2

Scope: ReturnBusinessDayInformation response to CB users: Information about the scheduled times and effective times of SSP events for the current SSP Operating day.

MessageName	ReturnBusinessDayInformation	<RtrBizDayInf>
Message Header		<MsgHdr>
Message Identification		<MsgId>ABC123456</MsgId>
Original Business Query		<OrgnlBizQry>
Message Identification		<MsgId>ABC123465</MsgId>
End of Original Business Query		</OrgnlBizQry>
End of Message Header		</MsgHdr>
BusinessDayReportOrErrorChoice		<RptOrErr>
BusinessReport		<BizRpt>
SystemIdentification		<SysId>
MarketInfrastructureIdentification		<MktInfrstrctrlId>
ExternalMarketInfrastructureCode		<Cd>TGT</Cd>
End of MarketInfrastructureIdentification		</MktInfrstrctrlId>
End of SystemIdentification		</SysId>
BusinessDayReportOrErrorChoice		<BizDayOrErr>
BusinessDayInformation		<BizDayInf>
SystemInformationPerCurrency		<SysInfPerCcy>
SystemCurrency		<SysCcy>EUR</SysCcy>
Event		<Evt>
BalanceTypeCode		<Tp>
GenericIdentification		<Prtry>
ProprietaryEventCode		<Id>STOD</Id>
End of GenericIdentification		</Prtry>
End of SystemEventTypeChoice		</Tp>
ScheduledTime		<SchlddTm>2012-05-04T18:45:00</SchlddTm>
EffectiveTime		<FctvTm>2012-05-04T18:46:3</FctvTm>
End of Event		</Evt>
Event		<Evt>
BalanceTypeCode		<Tp>
GenericIdentification		<Prtry>
ProprietaryEventCode		<Id>STOL</Id>
End of GenericIdentification		</Prtry>
End of SystemEventTypeChoice		</Tp>
ScheduledTime		<SchlddTm>2012-05-04T19:00:00</SchlddTm>
EffectiveTime		<FctvTm>2012-05-04T18:46:30</FctvTm>
End of Event		</Evt>
Event		<Evt>
BalanceTypeCode		<Tp>
GenericIdentification		<Prtry>
ProprietaryEventCode		<Id>SOAS</Id>
End of GenericIdentification		</Prtry>
End of SystemEventTypeChoice		</Tp>
ScheduledTime		<SchlddTm>2012-05-04T19:30:00</SchlddTm>
EffectiveTime		<FctvTm>2012-05-04T19:31:30</FctvTm>
End of Event		</Evt>
Event		<Evt>
BalanceTypeCode		<Tp>
GenericIdentification		<Prtry>
ProprietaryEventCode		<Id>SSCL</Id>

End of GenericIdentification	</Prtry>
End of SystemEventTypeChoice	</Tp>
ScheduledTime	<SchldTm>2012-05-04T22:00:00</SchldTm>
EffectiveTime	<FctvTm>2012-05-04T22:02:30</FctvTm>
End of Event	</Evt>
Event	<Evt>
BalanceTypeCode	<Tp>
GenericIdentification	<Prtry>
ProprietaryEventCode	<Id>CSAS</Id>
End of GenericIdentification	</Prtry>
End of SystemEventTypeChoice	</Tp>
ScheduledTime	<SchldTm>2012-05-05T05:00:00</SchldTm>
End of Event	</Evt>
Event	<Evt>
BalanceTypeCode	<Tp>
GenericIdentification	<Prtry>
ProprietaryEventCode	<Id>STBW</Id>
End of GenericIdentification	</Prtry>
End of SystemEventTypeChoice	</Tp>
ScheduledTime	<SchldTm>2012-05-05T06:45:00</SchldTm>
End of Event	</Evt>
Event	<Evt>
BalanceTypeCode	<Tp>
GenericIdentification	<Prtry>
ProprietaryEventCode	<Id>STDT</Id>
End of GenericIdentification	</Prtry>
End of SystemEventTypeChoice	</Tp>
ScheduledTime	<SchldTm>2012-05-05T07:00:00</SchldTm>
End of Event	</Evt>
Event	<Evt>
BalanceTypeCode	<Tp>
GenericIdentification	<Prtry>
ProprietaryEventCode	<Id>COCP</Id>
End of GenericIdentification	</Prtry>
End of SystemEventTypeChoice	</Tp>
ScheduledTime	<SchldTm>2012-05-05T17:00:00</SchldTm>
End of Event	</Evt>
Event	<Evt>
BalanceTypeCode	<Tp>
GenericIdentification	<Prtry>
ProprietaryEventCode	<Id>COCR</Id>
End of GenericIdentification	</Prtry>
End of SystemEventTypeChoice	</Tp>
ScheduledTime	<SchldTm>2012-05-05T17:07:30</SchldTm>
End of Event	</Evt>
Event	<Evt>
BalanceTypeCode	<Tp>
GenericIdentification	<Prtry>
ProprietaryEventCode	<Id>COBP</Id>
End of GenericIdentification	</Prtry>
End of SystemEventTypeChoice	</Tp>
ScheduledTime	<SchldTm>2012-05-05T18:00:00</SchldTm>

End of Event	</Evt>
Event	<Evt>
BalanceTypeCode	<Tp>
GenericIdentification	<Prtry>
ProprietaryEventCode	<Id>SEOD</Id>
End of GenericIdentification	</Prtry>
End of SystemEventTypeChoice	</Tp>
ScheduledTime	<SchlddTm>2012-05-05T18:07:30</SchlddTm>
EffectiveTime	<FctvTm>2012-05-05T18:07:30</FctvTm>
End of Event	</Evt>
Event	<Evt>
BalanceTypeCode	<Tp>
GenericIdentification	<Prtry>
ProprietaryEventCode	<Id>COMI</Id>
End of GenericIdentification	</Prtry>
End of SystemEventTypeChoice	</Tp>
ScheduledTime	<SchlddTm>2012-05-05T17:10:00</SchlddTm>
End of Event	</Evt>
Event	<Evt>
BalanceTypeCode	<Tp>
GenericIdentification	<Prtry>
ProprietaryEventCode	<Id>COSF</Id>
End of GenericIdentification	</Prtry>
End of SystemEventTypeChoice	</Tp>
ScheduledTime	<SchlddTm>2012-05-05T18:30:00</SchlddTm>
End of Event	</Evt>
End of BusinessDayInformation	</Evt>
End of BusinessDayReportOrErrorChoice	</BizDayInfRpt>
End of BusinessReport	</SysInfPerCcy>
End of BusinessDayReportOrErrorChoice	</BizRpt>
End Messagename	</RtrBizDayInf>
ReturnBusinessDayInformation	

6. 4.23 ReturnCreditLine

SSP Proprietary Messages

ReturnCreditLine_PM

Scope: The ReturnCreditLine message is used to return information on the credit line currently available on the

- RTGS account

The connected request is performed by a GetCreditLine message.

<camt.998.001.xx>

Structure:

Name Proprietary message	<PrtryMsg>
Message Header	<MsgHdr>
Message Identification	<MsgId></MsgId>
End of Message Header	</MsgHdr>
Related	<Rltd>
Reference	<Ref></Ref>
End of Related	</Rltd>
Proprietary Data	<PrtryData>
Proprietary Data type	<Tp>ReturnCreditLine</Tp>
Proprietary Data	<Data>
SSP Proprietary Data	<SspPrtryDt>
choice	xorBizRptOpriErr
BusinessReport	<BizRpt>
Credit Line Report	<CrdtLnRpt>
CreditLineIdentification	<CrdtId>
Account Owner	<AcctOwnr></AcctOwnr>
End Credit Line Identification	</CrdtId>
Credit Details	<CrdtDtls>
Amount without currency	<AmtWthtCcy></AmtWthtCcy>
End Credit Details	</CrdtDtls>
End of Credit Line Report	</CrdtLnRpt>
End of BusinessReport	</BizRpt>
OperationalError	<OpriErr>
Error handling	<Err>
Proprietary error code	<Prtry></Prtry>
End error handling	</Err>
Description	<Desc></Desc>
End of Operational Error	</OpriErr>
End choice	/xorBizRptOpriErr
End of SSP Proprietary Data	</SspPrtryDt>
End of Proprietary Data	</Data>
End of Proprietary Data	</PrtryData>
End proprietary message	</PrtryMsg>

Attributes:

name of attribute	format	short description	description
<PrtryMsg>		Name Proprietary message Mandatory A2A	Validation:
<MsgHdr>		Message Header Mandatory A2A	Set of characteristics specific to the message Message Reference Validation: [1..1]
<MsgId>-</MsgId>	35x	Message Identification Mandatory A2A	Message Identification Validation: [1..1]
</MsgHdr>		End of Message Header Mandatory	Validation: [1..1]
<Rltd>		Related Mandatory A2A	References a previously received message. Validation: [1..1]
<Ref>-</Ref>	35x	Reference Mandatory A2A	Unique and unambiguous reference Validation: [1..1]
</Rltd>		End of Related Mandatory A2A	End of Related Message Identification of the initiating Get Message (here GetCreditLine) Validation: [1..1]
<PrtryData>		Proprietary Data Mandatory A2A	Proprietary Data Validation: [1..1]
<Tp>-</Tp>		Proprietary Data type Mandatory A2A	Proprietary Data type here only ReturnCreditLine is possible Validation: [1..1]
<Data>		Proprietary Data Mandatory	Proprietary data content Validation: [1..1]
<SspPrtryDt>		SSP Proprietary Data Mandatory A2A	Root element for all SSP proprietary data Validation: [1..1]
xorBizRptOprlErr		choice Mandatory	choice amongst BizRpt und OprlErr Rule description: If BusinessReport is present then OperationalError is not allowed. If BusinessReport is not present, then OperationalError is mandatory. Validation:

name of attribute	format	short description	description
<BizRpt>		BusinessReport	BusinessReport Rule rationale: The message will contain either the information matching the search criteria of the related Get message or an error indication. Rule description: If BusinessReport is present then OperationalError is not allowed. If BusinessReport is not present, then OperationalError is mandatory.
		Mandatory A2A	Validation: [1..1]
<CrdtLnRpt>		Credit Line Report	Credit Line Report <CrdtId> <CrdtDtIs>
		Mandatory A2A	Validation: [1..1]
<CrdtId>		CreditLineIdentification	CreditLineIdentification free format tag
		Mandatory A2A	Validation: [1..1]
<AcctOwnr>-</AcctOwnr>	11x	Account Owner	BICIdentifier e.g. needed on behalf of third parties if e. g. the NCB are able to start several transactions on behalf their national banking community. BIC of the requested RTGS main account
		Mandatory A2A	Validation: [1..1]
</CrdtId>		End Credit Line Identification	End Credit Line Identification free format tag
		Mandatory A2A	Validation: [1..1]
<CrdtDtIs>		Credit Details	Credit Details free format tag
		Mandatory A2A	Validation: [1..1]
<AmtWthtCcy>-</AmtWthtCcy>	18n	Amount without currency	Number of monetary units specified in a currency where the unit of currency is implied by the context. The integer part of Amount must contain at least one digit. The decimal separator is a dot '.'. It is not mandatory but included in the maximum length. The number of digits following the dot must not exceed the maximum number allowed for that specific currency as specified in ISO 4217. Current Credit Line (EUR)
		Mandatory A2A	Validation: [1..1] in PM only 2 fraction digits are possible
</CrdtDtIs>		End Credit Details	End Credit Details
		Mandatory	Validation:

name of attribute	format	short description	description
		A2A	[1..1]
</CrdtLnRpt>		End of Credit Line Report	end of Credit Line Report
		Mandatory	Validation: [1..1]
		A2A	[1..1]
</BizRpt>		End of BusinessReport	End of BusinessReport
		Mandatory	Validation: [1..1]
		A2A	[1..1]
<OprlErr>		OperationalError	Rule rationale: The message will contain either the information matching the search criteria of the related Get message or an error indication. Rule description: If BusinessReport is present then OperationalError is not allowed. If BusinessReport is not present, then OperationalError is mandatory. Separate Specification see UDFS books regarding error codes
		Mandatory	Validation: [1..1]
		A2A	[1..1]
<Err>		Error handling	
		Mandatory	Validation: [1..1]
		A2A	[1..1]
<Prtry>-</Prtry>	4x	Proprietary error code	Specification of the error, in free format.
		Mandatory	Validation: [1..1]
		A2A	[1..1]
</Err>		End error handling	
		Mandatory	Validation: [1..1]
		A2A	[1..1]
<Desc>-</Desc>	140x	Description	Specification of the error, in free format.
		Optional	Validation: [0..1]
		A2A	[0..1]
</OprlErr>		End of Operational Error	End of Operational Error
		Mandatory	Validation: [1..1]
		A2A	[1..1]
/xorBizRptOprlErr		End choice	Rule description: If BusinessReport is present then OperationalError is not allowed. If BusinessReport is not present, then OperationalError is mandatory.
		Mandatory	Validation: [1..1]
</SspPrtryDt>		End of SSP Proprietary Data	End of Root element for all SSP proprietary data
		Mandatory	Validation: [1..1]
		A2A	[1..1]
</Data>		End of Proprietary Data	
		Mandatory	Validation: [1..1]
		A2A	[1..1]

name of attribute	format	short description	description
</PrtryData>		End of Proprietary Data	End of Proprietary Data
		Mandatory	Validation:
	A2A		[1..1]
</PrtryMsg>		End proprietary message	
		Mandatory	Validation:
	A2A		

Error Codes:

ReturnCreditLine_PM_1

Scope: Sample: ReturnCreditLine

Name Proprietary message	<PrtryMsg>
Message Header	<MsgHdr>
Message Identification	<MsgId>ABC123</MsgId>
End of Message Header	</MsgHdr>
Related	<Rltd>
Reference	<Ref>123ABC</Ref>
End of Related	</Rltd>
Proprietary Data	<PrtryData>
Proprietary Data type	<Tp>ReturnCreditLine</Tp>
Proprietary Data	<Data>
SSP Proprietary Data	<SspPrtryDt>
BusinessReport	<BizRpt>
Credit Line Report	<CrdtLnRpt>
CreditLineIdentification	<CrdtId>
Account Owner	<AcctOwnr>DEUTDEFFXXX</AcctOwnr>
End Credit Line Identification	</CrdtId>
Credit Details	<CrdtDtls>
Amount without currency	<AmtWthtCcy>30000.00</AmtWthtCcy>
End Credit Details	</CrdtDtls>
End of Credit Line Report	</CrdtLnRpt>
End of BusinessReport	</BizRpt>
End of SSP Proprietary Data	</SspPrtryDt>
End of Proprietary Data	</Data>
End of Proprietary Data	</PrtryData>
End proprietary message	</PrtryMsg>

6. 4.24 ReturnLimit

Cash Management Standard

ReturnLimit_PM

- Scope:**
- The ReturnLimit message is used to return information about
 - a bilateral limit (current or standing order limit) defined vis-à-vis
 - an other direct PM participant
 - a virtual group of accounts (definition and change of limits, possible for the whole group only, not for single account holder)
 - the multilateral limit (current or standing order limit) defined vis-à-vis all direct PM participants and virtual group of accounts without a bilateral limit.

The connected request is performed by a GetLimit message.

<camt.010.001.xx>

Structure:

Message name ReturnLimit	<RtrLmt>
Message Header	<MsgHdr>
Message Identification	<MsgId></MsgId>
Original Business Query	<OrgnlBizQry>
Message Identification	<MsgId></MsgId>
End of Original Business Query	</OrgnlBizQry>
End of Message Header	</MsgHdr>
BusinessReportOrErrorChoice	<RptOrErr>
choice	xorBizRptOprlErr
BusinessReport	<BizRpt>
CurrentLimit	<CurLmt>
LimitIdentification	<LmtId>
BilateralLimitCounterpartyId	<BilLmtCtrPtyId>
Financial Institution Identification	<FinInstnId>
BICFIIdentifier	<BICFI></BICFI>
End of Financial Institution Identification	</FinInstnId>
End of BilateralLimitCounterpartyId	</BilLmtCtrPtyId>
Limit Type	<Tp>
Limit Type Code	<Cd></Cd>
End of Limit Type	</Tp>
Account Owner	<AcctOwnr>
Financial Institution Identification	<FinInstnId>
BICFIIdentifier	<BICFI></BICFI>
End of Financial Institution Identification	</FinInstnId>
End of Account owner	</AcctOwnr>
End of Limit Identification	</LmtId>
Limit or Error choice	<LmtOrErr>
Limit	<Lmt>
Amount	<Amt>
Amount without currency	<AmtWthtCcy></AmtWthtCcy>
End of Amount	</Amt>
Credit or debit indicator	<CdtDbtInd></CdtDbtInd>
End of Limit	</Lmt>
End of Limit or Error choice	</LmtOrErr>
End of Current Limit	</CurLmt>
LiquidityManagementDefaultLimit	<DfltLmt>
LimitIdentification	<LmtId>
BilateralLimitCounterpartyId	<BilLmtCtrPtyId>

Financial Institution Identification	<FinInstnId>
BICFIIdentifier	<BICFI></BICFI>
End of Financial Institution Identification	</FinInstnId>
End of BilateralLimitCounterpartyId	</BilLmtCtrPtyId>
Limit Type	<Tp>
Limit Type Code	<Cd></Cd>
End of Limit Type	</Tp>
Account Owner	<AcctOwnr>
Financial Institution Identification	<FinInstnId>
BICFIIdentifier	<BICFI></BICFI>
End of Financial Institution Identification	</FinInstnId>
End of Account owner	</AcctOwnr>
End of Limit Identification	</LmtId>
Limit or Error choice	<LmtOrErr>
Limit	<Lmt>
Amount	<Amt>
Amount without currency	<AmtWthtCcy></AmtWthtCcy>
End of Amount	</Amt>
Credit or debit indicator	<CdtDbtInd></CdtDbtInd>
End of Limit	</Lmt>
End of Limit or Error choice	</LmtOrErr>
End of liquidity management default limit.	</DfltLmt>
End of BusinessReport	</BizRpt>
OperationalError	<OprlErr>
Error handling	<Err>
Proprietary error code	<Prtry></Prtry>
End error handling	</Err>
Description	<Desc></Desc>
End of Operational Error	</OprlErr>
End choice	/xorBizRptOprlErr
End of BusinessReportOrErrorChoice	</RptOrErr>
End Messagename ReturnLimit	</RtrLmt>

Attributes:

name of attribute	format	short description	description
<RtrLmt>		MessageName ReturnLimit	MessageName ReturnLimit
		Mandatory	Validation:
		A2A	
<MsgHdr>		Message Header	Set of characteristics specific to the message
		Mandatory	Validation:
		A2A	[1..1]
<MsgId>-</MsgId>	35x	Message Identification	Message Identification
		Mandatory	Validation:
		A2A	[1..1]
<OrgnlBizQry>		Original Business Query	Original Business Query, reference to the query
		Mandatory	Validation:
		A2A	[1..1]
<MsgId>-</MsgId>	35x	Message Identification	Message Identification
		Mandatory	Validation:
		A2A	[1..1]
</OrgnlBizQry>		End of Original Business Query	End of Original Business Query, reference to the query
		Mandatory	Validation:
		A2A	[1..1]
</MsgHdr>		End of Message Header	
		Mandatory	Validation:
		A2A	[1..1]
<RptOrErr>		BusinessReportOrErrorChoice	
		Mandatory	Validation:
			[1..1]
xorBizRptOprlErr		choice	choice amongst BizRpt und OprlErr
			Rule description: If BusinessReport is present then OperationalError is not allowed. If BusinessReport is not present, then OperationalError is mandatory.
		Mandatory	Validation:
<BizRpt>		BusinessReport	BusinessReport
			Rule rationale: The message will contain either the information matching the search criteria of the related Get message or an error indication.
			Rule description: If BusinessReport is present then OperationalError is not allowed. If BusinessReport is not present, then OperationalError is mandatory.
		Mandatory	Validation:
		A2A	[1..1]
<CurLmt>		CurrentLimit	CurrentLimit
		Optional	Validation:

name of attribute	format	short description	description
		A2A	[0..n]
<LmtId>		LimitIdentification	Identification of the limit on which information is requested.
		Mandatory	Validation:
		A2A	[1..1]
<BilLmtCtrPtyId>		BilateralLimitCounterpartyId	Unique and unambiguous identification of a member within a system, assigned using the member identification scheme of the system.
		Optional	Validation:
		A2A	[0..1] Counterpart is filled in the case of an asked Bilateral Limit,
<FinInstnId>		Financial Institution Identification	Financial Institution Identification
		Mandatory	Validation:
			[1..1]
<BICFI>-</BICFI>	4!a2!a2!c3!c	BICFIIdentifier	BICFIIdentifier
		Mandatory	Validation:
		A2A	[1..1]
</FinInstnId>		End of Financial Institution Identification	End of Financial Institution Identification
		Mandatory	Validation:
			[1..1]
</BilLmtCtrPtyId>		End of BilateralLimitCounterpartyId	End ofBilateralLimitCounterpartyIdentification
		Optional	Validation:
		A2A	[0..1]
<Tp>		Limit Type	Limit Type
		Mandatory	Validation:
			[1..1]
<Cd>-</Cd>		Limit Type Code	Limit Type Code
			SSP restricted code list:
			BILI = Bilateral Limit is applied by one party to a specific counterparty, and corresponds to the maximum amount of traffic party setting the limit can send to that counterparty. The limit can be expressed as a debit or a credit limit. With the help of a bilateral limit, the direct participant restricts the use of liquidity when clearing payments with another direct participant.
			MULT = Multilateral Limit is a maximum amount value applied to, or by, a participant to a set of counterparties. The multilateral limit is taken into account by the transaction administrator to contain the risk in the system. With the help of the multilateral limit, the direct participant restricts the use of liquidity when clearing payments with all other direct participants for which no bilateral limit is set
			for current Limit
		Mandatory	Validation:
		A2A	[1..1] only BILI and MULT is needed in PM
</Tp>		End of Limit Type	End of Limit Type

name of attribute	format	short description	description
		Mandatory	Validation: [1..1]
<AcctOwnc>		Account Owner	BIC RTGS main account
		Mandatory	Validation: ****[1..1]differs from the cash management standard
		A2A	
<FinInstncd>		Financial Institution Identification	Financial Institution Identification
		Mandatory	Validation: [1..1]
<BICFI>-</BICFI>	4!a2!a2!c3!c	BICFIIdentifier	BICFIIdentifier
		Mandatory	Validation: [1..1]
</FinInstncd>		End of Financial Institution Identification	End of Financial Institution Identification
		Mandatory	Validation: [1..1]
</AcctOwnc>		End of Account owner	
		Mandatory	Validation: ****[1..1]
</Lmtncd>		End of Limit Identification	End of Limit Identification
		Mandatory	Validation: [1..1]
		A2A	
<LmtOrErr>		Limit or Error choice	
		Mandatory	Validation: [1..1]
<Lmt>		Limit	The requested information on the limit.
		Mandatory	Validation: [1..1] BusinessError is not used
		A2A	
<Amt>		Amount	Current Value (EUR), Current Limit Position
		Mandatory	Validation: [1..1]
		A2A	
<AmtWthtCcy>-</AmtWthtCcy>	18n	Amount without currency	Number of monetary units specified in a currency where the unit of currency is implied by the context. totalDigits = 18 fractionDigits = 5
		Mandatory	Validation: [1..1] In PM only 2 fraction digits are possible
		A2A	
</Amt>		End of Amount	End of Amount
		Mandatory	Validation: [1..1]
		A2A	
<CdtDbtncd>-</CdtDbtncd>	4!a	Credit or debit indicator	CRDT = Credit Operation is an increase. DBIT = Debit

name of attribute	format	short description	description
			Operation is a decrease. differs from the cash management standard
		Mandatory	Validation:
		A2A	*****[1..1]only debit is possible in PM
</Lmt>		End of Limit	End of Limit
		Mandatory	Validation:
		A2A	[1..1]
</LmtOrErr>		End of Limit or Error choice	
		Mandatory	Validation:
			[1..1]
</CurLmt>		End of Current Limit	End of Current Limit
		Optional	Validation:
		A2A	[0..n]
<DfltLmt>		LiquidityManagementDefaultLimit	Report is given for a default liquidity management type limit. Cash management feature limiting the amount of liquidity needed to perform clearing and settlement operations. At any point in time during the process, the limit imposes the maximum amount of liquidity available for operations concerning the system or other managed elements, eg, transaction amount or counterparty.
		Optional	Validation:
		A2A	[0..n]
<LmtId>		LimitIdentification	Identification of the limit on which information is requested.
		Mandatory	Validation:
		A2A	[1..1]
<BilLmtCtrPtyId>		BilateralLimitCounterpartyId	Unique and unambiguous identification of a member within a system, assigned using the member identification scheme of the system.
		Optional	Validation:
		A2A	[0..1] Counterpart is filled in the case of an asked Bilateral Limit.
<FinInstId>		Financial Institution Identification	Financial Institution Identification
		Mandatory	Validation:
			[1..1]
<BICFI>-</BICFI>	4!a2!a2!c3!c	BICFIIdentifier	BICFIIdentifier
		Mandatory	Validation:
		A2A	[1..1]
</FinInstId>		End of Financial Institution Identification	End of Financial Institution Identification
		Mandatory	Validation:
			[1..1]
</BilLmtCtrPtyId>		End of BilateralLimitCounterpartyId	End ofBilateralLimitCounterpartyIdentification
		Optional	Validation:
		A2A	[0..1]

name of attribute	format	short description	description
<Tp>		Limit Type	Limit Type
		Mandatory	Validation: [1..1]
<Cd>-</Cd>		Limit Type Code	Limit Type Code
			SSP restricted code list: BILI = Bilateral Limit is applied by one party to a specific counterparty, and corresponds to the maximum amount of traffic party setting the limit can send to that counterparty. The limit can be expressed as a debit or a credit limit. With the help of a bilateral limit, the direct participant restricts the use of liquidity when clearing payments with another direct participant. MULT = Multilateral Limit is a maximum amount value applied to, or by, a participant to a set of counterparties. The multilateral limit is taken into account by the transaction administrator to contain the risk in the system. With the help of the multilateral limit, the direct participant restricts the use of liquidity when clearing payments with all other direct participants for which no bilateral limit is set for Limits defined (Standing Order)
		Mandatory	Validation: [1..1] only BILI and MULT is needed in PM,
</Tp>		End of Limit Type	End of Limit Type
		Mandatory	Validation: [1..1]
<AcctOwnr>		Account Owner	BIC of the RTGS main account
		Mandatory	Validation: ****[1..1] differs from the cash management standard
		A2A	
<FinInstnId>		Financial Institution Identification	Financial Institution Identification
		Mandatory	Validation: [1..1]
<BICFI>-</BICFI>	4!a2!a2!c3!c	BICFIIdentifier	BICFIIdentifier
		Mandatory	Validation: [1..1]
</FinInstnId>		End of Financial Institution Identification	End of Financial Institution Identification
		Mandatory	Validation: [1..1]
</AcctOwnr>		End of Account owner	
		Mandatory	Validation: ****[1..1]
</LmtId>		End of Limit Identification	End of Limit Identification
		Mandatory	Validation: [1..1]
		A2A	
<LmtOrErr>		Limit or Error choice	
		Mandatory	Validation:

name of attribute	format	short description	description
			[1..1]
<Lmt>		Limit	The requested information on the limit.
		Mandatory	Validation:
		A2A	[1..1]
<Amt>		Amount	
		Mandatory	Validation:
		A2A	[1..1]
<AmtWthtCcy>- </AmtWthtCcy>	18n	Amount without currency	Number of monetary units specified in a currency where the unit of currency is implied by the context.
			totalDigits = 18
			fractionDigits = 5
			Defined Limit (EUR)
		Mandatory	Validation:
		A2A	[1..1] In PM only 2 fraction digits are possible
</Amt>		End of Amount	End of Amount
		Mandatory	Validation:
		A2A	[1..1]
<CdtDbtInd>-</CdtDbtInd>	4!a	Credit or debit indicator	CRDT = Credit Operation is an increase.
			DBIT = Debit Operation is a decrease.
		Mandatory	Validation:
		A2A	[1..1] only debit is used in PM for Limits
</Lmt>		End of Limit	End of Limit
		Mandatory	Validation:
		A2A	[1..1]
</LmtOrErr>		End of Limit or Error choice	
		Mandatory	Validation:
			[1..1]
</DfltLmt>		End of liquidity management default limit.	End of liquidity management default limit.
		Optional	Validation:
		A2A	[0..n]
</BizRpt>		End of BusinessReport	End of BusinessReport
		Mandatory	Validation:
		A2A	[1..1]
<OprlErr>		OperationalError	Rule rationale: The message will contain either the information matching the search criteria of the related Get message or an error indication.
			Rule description: If BusinessReport is present then OperationalError is not allowed. If BusinessReport is not present, then OperationalError is mandatory.
			Separate Specification see UDFS books regarding error codes
		Mandatory	Validation:

name of attribute	format	short description	description
		A2A	[1..1]
<Err>		Error handling	
		Mandatory	Validation: [1..1]
		A2A	[1..1]
<Prtry>-</Prtry>	4x	Proprietary error code	Specification of the error, in free format.
		Mandatory	Validation: [1..1]
		A2A	[1..1]
</Err>		End error handling	
		Mandatory	Validation: [1..1]
		A2A	[1..1]
<Desc>-</Desc>	140x	Description	Specification of the error, in free format.
		Optional	Validation: [0..1]
		A2A	[0..1]
</OprlErr>		End of Operational Error	End of Operational Error
		Mandatory	Validation: [1..1]
		A2A	[1..1]
/xorBizRptOprlErr		End choice	Rule description: If BusinessReport is present then OperationalError is not allowed. If BusinessReport is not present, then OperationalError is mandatory.
		Mandatory	Validation: End of choice BizRpt und OprlErr
</RptOrErr>		End of BusinessReportOrErrorChoice	
		Mandatory	Validation: [1..1]
</RtrLmt>		End Messagename ReturnLimit	
		Mandatory	Validation:
		A2A	

Error Codes:

ReturnLimit_PM_1

Scope: Return Limit response for current multilateral limit

MessageName ReturnLimit	<RtrLmt>
Message Header	<MsgHdr>
Message Identification	<MsgId>ABC123456</MsgId>
Original Business Query	<OrgnlBizQry>
Message Identification	<MsgId>ABCDEFGHIJKLMNPOQRSTUVWXYZabcdefghi</MsgId>
End of Original Business Query	</OrgnlBizQry>
End of Message Header	</MsgHdr>
BusinessReportOrErrorChoice	<RptOrErr>
BusinessReport	<BizRpt>
CurrentLimit	<CurLmt>
Limit Type	<Tp>
Limit Type Code	<Cd>MULT</Cd>
End of Limit Type	</Tp>
Account Owner	<AcctOwnr>
Financial Institution Identification	<FinInstnId>
BICFIIdentifier	<BICFI>DEUTDEFF500</BICFI>
End of Financial Institution Identification	</FinInstnId>
End of Account owner	</AcctOwnr>
End of Limit Identification	</LmtId>
Limit or Error choice	<LmtOrErr>
Limit	<Lmt>
Amount	<Amt>
Amount without currency	<AmtWthtCcy>7000000.00</AmtWthtCcy>
End of Amount	</Amt>
Credit or debit indicator	<CdtDbtInd>DBIT</CdtDbtInd>
End of Limit	</Lmt>
End of Limit or Error choice	</LmtOrErr>
End of Current Limit	</CurLmt>
End of BusinessReport	</BizRpt>
End of BusinessReportOrErrorChoice	</RptOrErr>
End MessageName ReturnLimit	</RtrLmt>

ReturnLimit_PM_2

Scope: Return Limit response for bilateral Limit standing order (defined limit) of a RTGS Account

MessageName ReturnLimit	<RtrLmt>
Message Header	<MsgHdr>
Message Identification	<MsgId>ABC123456</MsgId>
Original Business Query	<OrgnlBizQry>
Message Identification	<MsgId>ABCDEFGHJKLMNOPQRSTUVWXYZabcdefghi</MsgId>
End of Original Business Query	</OrgnlBizQry>
End of Message Header	</MsgHdr>
BusinessReportOrErrorChoice	<RptOrErr>
BusinessReport	<BizRpt>
LiquidityManagementDefaultLimit	<DfltLmt>
LimitIdentification	<LmtId>
BilateralLimitCounterpartyId	<BilLmtCtrPtyId>
Financial Institution Identification	<FinInstId>
BICFIIdentifier	<BICFI>DEUTDEFF</BICFI>
End of Financial Institution Identification	</FinInstId>
End of BilateralLimitCounterpartyId	</BilLmtCtrPtyId>
Limit Type	<Tp>
Limit Type Code	<Cd>BILI</Cd>
End of Limit Type	</Tp>
Account Owner	<AcctOwnr>
Financial Institution Identification	<FinInstId>
BICFIIdentifier	<BICFI>DRESDEFF</BICFI>
End of Financial Institution Identification	</FinInstId>
End of Account owner	</AcctOwnr>
End of Limit Identification	</LmtId>
Limit or Error choice	<LmtOrErr>
Limit	<Lmt>
Amount	<Amt>
Amount without currency	<AmtWthtCcy>8000000.00</AmtWthtCcy>
End of Amount	</Amt>
Credit or debit indicator	<CdtDbtInd>DBIT</CdtDbtInd>
End of Limit	</Lmt>
End of Limit or Error choice	</LmtOrErr>
End of liquidity management default limit.	</DfltLmt>
End of BusinessReport	</BizRpt>
End of BusinessReportOrErrorChoice	</RptOrErr>
End MessageName ReturnLimit	</RtrLmt>

ReturnLimit_PM_3

Scope: Return Limit response for standing order multilateral limit

MessageName ReturnLimit	<RtrLmt>
Message Header	<MsgHdr>
Message Identification	<MsgId>ABCDEFGHIJKLMNQRSTUvwxyzabcdefghi</MsgId>
Original Business Query	<OrgnlBizQry>
Message Identification	<MsgId>ABC123</MsgId>
End of Original Business Query	</OrgnlBizQry>
End of Message Header	</MsgHdr>
BusinessReportOrErrorChoice	<RptOrErr>
BusinessReport	<BizRpt>
LiquidityManagementDefaultLimit	<DfltLmt>
LimitIdentification	<LmtId>
Limit Type	<Tp>
Limit Type Code	<Cd>MULT</Cd>
End of Limit Type	</Tp>
Account Owner	<AcctOwnr>
Financial Institution Identification	<FinInstnId>
BICFIIdentifier	<BICFI>DEUTDEFFXXX</BICFI>
End of Financial Institution Identification	</FinInstnId>
End of Account owner	</AcctOwnr>
End of Limit Identification	</LmtId>
Limit or Error choice	<LmtOrErr>
Limit	<Lmt>
Amount	<Amt>
Amount without currency	<AmtWthtCcy>5000000.00</AmtWthtCcy>
End of Amount	</Amt>
Credit or debit indicator	<CdtDbtInd>DBIT</CdtDbtInd>
End of Limit	</Lmt>
End of Limit or Error choice	</LmtOrErr>
End of liquidity management default limit.	</DfltLmt>
End of BusinessReport	</BizRpt>
End of BusinessReportOrErrorChoice	</RptOrErr>
End MessageName ReturnLimit	</RtrLmt>

ReturnLimit_PM_4

Scope: Return Limit response for bilateral Limit standing order (defined limit) of a RTGS Account

MessageName ReturnLimit	<RtrLmt>
Message Header	<MsgHdr>
Message Identification	<MsgId>ABC123</MsgId>
Original Business Query	<OrgnlBizQry>
Message Identification	<MsgId>123ABC</MsgId>
End of Original Business Query	</OrgnlBizQry>
BusinessReportOrErrorChoice	<RptOrErr>
BusinessReport	<BizRpt>
End of Limit	</Lmt>
LiquidityManagementDefaultLimit	<DfltLmt>
LimitIdentification	<LmtId>
Limit Type	<Tp>
Limit Type Code	<Cd>BILI</Cd>
End of Limit Type	</Tp>
Account Owner	<AcctOwnr>
Financial Institution Identification	<FinInstnId>
BICFIIdentifier	<BICFI>DEUTDEFFXXX</BICFI>
End of Financial Institution Identification	</FinInstnId>
End of Account owner	</AcctOwnr>
End of Limit Identification	</LmtId>
Limit or Error choice	<LmtOrErr>
Limit	<Lmt>
Amount	<Amt>
Amount without currency	<AmtWthtCcy>6000000.00</AmtWthtCcy>
End of Amount	</Amt>
Credit or debit indicator	<CdtDbtInd>DBIT</CdtDbtInd>
End of Limit or Error choice	</LmtOrErr>
End of liquidity management default limit.	</DfltLmt>
End of BusinessReport	</BizRpt>
End of BusinessReportOrErrorChoice	</RptOrErr>
End MessageName ReturnLimit	</RtrLmt>

6. 4.25 ReturnReservation

Cash Management Standard

ReturnReservation_PM

Scope: The ReturnReservation message is used to return information about

- the highly-urgent reserve (current or standing order)
- the urgent reserve (current or standing order)
- to an
- other direct PM participant
- a virtual group of accounts (reservation of liquidity for the whole group only. Not for single account holder)

The connected request is performed by a GetReservation message.

<camt.047.001.xx>

Structure:

Message name for ReturnReservation	<RtrRsvatn>
Message Header	<MsgHdr>
Message Identification	<MsgId></MsgId>
Original Business Query	<OrgnlBizQry>
Message Identification	<MsgId></MsgId>
End of Original Business Query	</OrgnlBizQry>
End of Message Header	</MsgHdr>
BusinessReportOrErrorChoice choice	<RptOrErr> xorBizRptOprlErr
BusinessReport	<BizRpt>
CurrentReservation	<CurRsvatn>
Reservationidentification	<RsvatnId>
ReservationType	<Tp>
ReservationTypeCode	<Cd></Cd>
End of ReservationType	</Tp>
Account Owner	<AcctOwnr>
Financial Institution Identification	<FinInstnId>
BICFIIdentifier	<BICFI></BICFI>
End of Financial Institution Identification	</FinInstnId>
End of Account owner	</AcctOwnr>
End of Reservationidentification	</RsvatnId>
Reservation or Error choice	<RsvatnOrErr>
Reservation	<Rsvatn>
Amount	<Amt>
Amount without currency	<AmtWthtCcy></AmtWthtCcy>
End of Amount	</Amt>
ReservationStatus	<Sts>
ReservationTypeCode	<Cd></Cd>
End of ReservationStatus	</Sts>
End of Reservation	</Rsvatn>
End of Reservation or Error choice	</RsvatnOrErr>
End of CurrentReservation	</CurRsvatn>
DefaultReservation	<DfltRsvatn>
Reservationidentification	<RsvatnId>
ReservationType	<Tp>
ReservationTypeCode	<Cd></Cd>
End of ReservationType	</Tp>
Account Owner	<AcctOwnr>
Financial Institution Identification	<FinInstnId>

BICFIIdentifier	<BICFI></BICFI>
End of Financial Institution Identification	</FinInstnId>
End of Account owner	</AcctOwnr>
End of Reservationidentification	</RsvatnId>
Reservation or Error choice	<RsvatnOrErr>
Reservation	<Rsvatn>
Amount	<Amt>
Amount without currency	<AmtWthtCcy></AmtWthtCcy>
End of Amount	</Amt>
End of Reservation	</Rsvatn>
End of Reservation or Error choice	</RsvatnOrErr>
End of DefaultReservation	</DfltRsvatn>
End of BusinessReport	</BizRpt>
OperationalError	<OprlErr>
Error handling	<Err>
Proprietary error code	<Prtry></Prtry>
End error handling	</Err>
Description	<Desc></Desc>
End of Operational Error	</OprlErr>
End choice	/xorBizRptOprlErr
End of BusinessReportOrErrorChoice	</RptOrErr>
End of message name for ReturnReservation	</RtrRsvatn>

Attributes:

name of attribute	format	short description	description
<RtrRsvatn>		Message name for ReturnReservation Mandatory A2A	Message name for ReturnReservation Validation:
<MsgHdr>		Message Header Mandatory A2A	Set of characteristics specific to the message Validation: [1..1]
<MsgId>-</MsgId>	35x	Message Identification Mandatory A2A	Message Identification Validation: [1..1]
<OrgnlBizQry>		Original Business Query Mandatory A2A	Original Business Query, reference to the query Validation: [1..1]
<MsgId>-</MsgId>	35x	Message Identification Mandatory A2A	Message Identification Validation: [1..1]
</OrgnlBizQry>		End of Original Business Query Mandatory A2A	End of Original Business Query, reference to the query Validation: [1..1]
</MsgHdr>		End of Message Header Mandatory A2A	Validation: [1..1]
<RptOrErr>		BusinessReportOrErrorChoice Mandatory	Validation: [1..1]
xorBizRptOprlErr		choice Mandatory	choice amongst BizRpt und OprlErr Rule description: If BusinessReport is present then OperationalError is not allowed. If BusinessReport is not present, then OperationalError is mandatory. Validation: [1..1]
<BizRpt>		BusinessReport Mandatory A2A	Validation: [1..1]
<CurRsvatn>		CurrentReservation Optional A2A	CurrentReservation Validation: ****[0..4]differs from the cash management standard
<RsvatnId>		Reservationidentification Mandatory A2A	Reservationidentification Validation: [1..1]

name of attribute	format	short description	description
<Tp>		ReservationType	ReservationType
		Mandatory	Validation: [1..1]
<Cd>-</Cd>		ReservationTypeCode	ReservationTypeCode
			SSP restricted code list: UPAR = UrgentPaymentReservation Amount set aside by a participant to reserve liquidity from its own account, exclusively for executing urgent payments. HPAR = HighlyUrgentPayment reservation Amount set aside by a participant to reserve liquidity from its own account, exclusively for executing highly urgent payment
		Mandatory	Validation: [1..1] in PM only UPAR and HPAR are used
</Tp>		End of ReservationType	End of ReservationType
		Mandatory	Validation: [1..1]
<AcctOwnr>		Account Owner	BIC of the RTGS main account / SSP-Participant
		Mandatory	Validation: *****[1..1]differs from the cash management standard
		A2A	
<FinInstnId>		Financial Institution Identification	Financial Institution Identification
		Mandatory	Validation: [1..1]
<BICFI>-</BICFI>	4!a2!a2!c3!c	BICFIIdentifier	BICFIIdentifier
		Mandatory	Validation: [1..1]
</FinInstnId>		End of Financial Institution Identification	End of Financial Institution Identification
		Mandatory	Validation: [1..1]
</AcctOwnr>		End of Account owner	
		Mandatory	Validation: *****[1..1]
</RsvatnId>		End of Reservationidentification	end of Reservationidentification
		Mandatory	Validation: [1..1]
		A2A	
<RsvatnOrErr>		Reservation or Error choice	
		Mandatory	Validation: [1..1]
<Rsvatn>		Reservation	Reservation
		Mandatory	Validation: [1..1]
		A2A	
<Amt>		Amount	

name of attribute	format	short description	description
		Mandatory A2A	Validation: [1..1]
<AmtWthtCcy>- </AmtWthtCcy>	18n	Amount without currency Mandatory A2A	Validation: [1..1] in PM only 2 fraction digits are possible
</Amt>		End of Amount Mandatory A2A	Validation: [1..1]
<Sts>		ReservationStatus Optional	Validation: [0..1]
<Cd>-</Cd>		ReservationTypeCode Mandatory	ReservationTypeCode SSP restricted code list: UPAR = UrgentPaymentReservation Amount set aside by a participant to reserve liquidity from its own account, exclusively for executing urgent payments. HPAR = HighlyUrgentPayment reservation Amount set aside by a participant to reserve liquidity from its own account, exclusively for executing highly urgent payment The amount reported with status 'REQD' is the pending reservation (in case of partially processed tasks) = the requested amount of the ModifyReservation order ./ the currently enabled value Validation: [0..1]SSP reports statuses 'ENAB' and 'REQD' for current reservations. In case of default reservations this element is not used.
</Sts>		End of ReservationStatus Optional	Validation: [0..1]
</Rsvatn>		End of Reservation Mandatory A2A	end of Reservation Validation: [1..1]
</RsvatnOrErr>		End of Reservation or Error choice Mandatory	Validation: [1..1]
</CurRsvatn>		End of CurrentReservation Optional A2A	end of CurrentReservation Validation: [0..4]
<DfltRsvatn>		DefaultReservation Optional A2A	DefaultReservation Validation: *****[0..2]differs from the cash management standard Reservation for standing order
<RsvatnId>		Reservationidentification	Reservationidentification

name of attribute	format	short description	description
		Mandatory	Validation:
		A2A	[1..1]
<Tp>		ReservationType	ReservationType
		Mandatory	Validation:
			[1..1]
<Cd>-</Cd>		ReservationTypeCode	ReservationTypeCode
			SSP restricted code list:
			UPAR = UrgentPaymentReservation Amount set aside by a participant to reserve liquidity from its own account, exclusively for executing urgent payments.
			HPAR = HighlyUrgentPayment reservation Amount set aside by a participant to reserve liquidity from its own account, exclusively for executing highly urgent payment
		Mandatory	Validation:
		A2A	[1..1] in PM only UPAR and HPAR are used
</Tp>		End of ReservationType	End of ReservationType
		Mandatory	Validation:
			[1..1]
<AcctOwnr>		Account Owner	BIC of the RTGS main account / SSP-Participant
		Mandatory	Validation:
		A2A	****[1..1] differs from the cash management standard
<FinInstnId>		Financial Institution Identification	Financial Institution Identification
		Mandatory	Validation:
			[1..1]
<BICFI>-</BICFI>	4!a2!a2!c3!c	BICFIIdentifier	BICFIIdentifier
		Mandatory	Validation:
			[1..1]
</FinInstnId>		End of Financial Institution Identification	End of Financial Institution Identification
		Mandatory	Validation:
			[1..1]
</AcctOwnr>		End of Account owner	
		Mandatory	Validation:
			[1..1]
</RsvatnId>		End of Reservationidentification	end of Reservationidentification
		Mandatory	Validation:
		A2A	[1..1]
<RsvatnOrErr>		Reservation or Error choice	
		Mandatory	Validation:
			[1..1]
<Rsvatn>		Reservation	Reservation
		Mandatory	Validation:

name of attribute	format	short description	description
		A2A	[1..1]
<Amt>		Amount	
		Mandatory	Validation:
		A2A	[1..1]
<AmtWthtCcy>- </AmtWthtCcy>	18n	Amount without currency	
		Mandatory	Validation:
		A2A	[1..1] in PM only 2 fraction digits are possible
</Amt>		End of Amount	
		Mandatory	Validation:
		A2A	[1..1]
</Rsvatn>		End of Reservation	end of Reservation
		Mandatory	Validation:
		A2A	[1..1]
</RsvatnOrErr>		End of Reservation or Error choice	
		Mandatory	Validation:
			[1..1]
</DfltRsvatn>		End of DefaultReservation	end of DefaultReservation
		Optional	Validation:
		A2A	[0..2]
</BizRpt>		End of BusinessReport	
		Mandatory	Validation:
		A2A	[1..1]
<OprlErr>		OperationalError	Indicates an operational error
			Rule description: If BusinessReport is present then OperationalError is not allowed. If BusinessReport is not present, then OperationalError is mandatory.
		Mandatory	Validation:
		A2A	[1..1]
<Err>		Error handling	
		Mandatory	Validation:
		A2A	[1..1]
<Prtry>-</Prtry>	4x	Proprietary error code	Specification of the error, in free format.
		Mandatory	Validation:
		A2A	[1..1]
</Err>		End error handling	
		Mandatory	Validation:
		A2A	[1..1]
<Desc>-</Desc>	140x	Description	Specification of the error, in free format.
		Optional	Validation:
		A2A	[0..1]

name of attribute	format	short description	description
</OprlErr>		End of Operational Error	End of Operational Error
		Mandatory	Validation:
		A2A	[1..1]
/xorBizRptOprlErr		End choice	Rule description: If BusinessReport is present then OperationalError is not allowed. If BusinessReport is not present, then OperationalError is mandatory.
		Mandatory	Validation:
</RptOrErr>		End of BusinessReportOrErrorChoice	
		Mandatory	Validation:
			[1..1]
</RtrRsvatn>		End of message name for ReturnReservation	end of message name for ReturnReservation
		Mandatory	Validation:
		A2A	

Error Codes:

ReturnReservation_PM_1

Scope: ReturnReservation reporting current and standing order reservations for urgent payments. An increase of current urgent reservation is partially pending. Sending party and BIC of the SSP-Participant are identic.

Message name for ReturnReservation	<RtrRsvatn>
Message Header	<MsgHdr>
Message Identification	<Id>ABC12358</Id>
Original Business Query	<OrgnlBizQry>
Message Identification	<MsgId>XYZxyz987</MsgId>
End of Original Business Query	</OrgnlBizQry>
End of Message Header	</MsgHdr>
BusinessReportOrErrorChoice	<RptOrErr>
BusinessReport	<BizRpt>
CurrentReservation	<CurRsvatn>
Reservationidentification	<RsvatnId>
ReservationType	<Tp>
ReservationTypeCode	<Cd>UPAR</Cd>
End of ReservationType	</Tp>
Account Owner	<AcctOwnr>
Financial Institution Identification	<FinInstnId>
BICFIIdentifier	<BICFI>DEUTDEFFXXX</BICFI>
End of Financial Institution Identification	</FinInstnId>
End of Account owner	</AcctOwnr>
End of Reservationidentification	</RsvatnId>
Reservation or Error choice	<RsvatnOrErr>
Amount	<Amt>
Amount without currency	<AmtWthtCcy>7000000.00</AmtWthtCcy>
End of Amount	</Amt>
ReservationStatus	<Sts>
ReservationTypeCode	<Cd>ENAB</Cd>
End of ReservationStatus	</Sts>
End of Reservation	</Rsvatn>
End of Reservation or Error choice	</RsvatnOrErr>
End of CurrentReservation	</CurRsvatn>
CurrentReservation	<CurRsvatn>
Reservationidentification	<RsvatnId>
ReservationType	<Tp>
ReservationTypeCode	<Cd>UPAR</Cd>
End of ReservationType	</Tp>
Account Owner	<AcctOwnr>
Financial Institution Identification	<FinInstnId>
BICFIIdentifier	<BICFI>DEUTDEFFXXX</BICFI>
End of Financial Institution Identification	</FinInstnId>
End of Account owner	</AcctOwnr>
End of Reservationidentification	</RsvatnId>
Reservation or Error choice	<RsvatnOrErr>
Reservation	<Rsvatn>
Amount	<Amt>
Amount without currency	<AmtWthtCcy>2000000.00</AmtWthtCcy>
End of Amount	</Amt>
ReservationStatus	<Sts>
ReservationTypeCode	<Cd>REQD</Cd>
End of ReservationStatus	</Sts>

End of Reservation	</Rsvatn>
End of Reservation or Error choice	</RsvatnOrErr>
End of CurrentReservation	</CurRsvatn>
DefaultReservation	<DfltRsvatn>
Reservationidentification	<RsvatnId>
ReservationType	<Tp>
ReservationTypeCode	<Cd>UPAR</Cd>
End of ReservationType	</Tp>
Account Owner	<AcctOwnr>
Financial Institution Identification	<FinInstnId>
BICFIIdentifier	<BICFI>DEUTDEFFXXX</BICFI>
End of Financial Institution Identification	</FinInstnId>
End of Account owner	</AcctOwnr>
End of Reservationidentification	</RsvatnId>
Reservation or Error choice	<RsvatnOrErr>
Reservation	<Rsvatn>
Amount	<Amt>
Amount without currency	<AmtWthtCcy>6000000.00</AmtWthtCcy>
End of Amount	</Amt>
End of Reservation	</Rsvatn>
End of Reservation or Error choice	</RsvatnOrErr>
End of DefaultReservation	</DfltRsvatn>
End of BusinessReport	</BizRpt>
End of BusinessReportOrErrorChoice	</RptOrErr>
End of message name for ReturnReservation	</RtrRsvatn>

ReturnReservation_PM_2

Scope: Return Reservation within current and standing order reservations for urgent and highly urgent payments. Sending party and BIC of the SSP-Participant are different ("on behalf of scenario").

Message name for ReturnReservation	<RtrRsvatn>
Message Header	<MsgHdr>
Message Identification	<Id>ABC123568</Id>
Original Business Query	<OrgnlBizQry>
Message Identification	<MsgId>XYZxyz987</MsgId>
End of Original Business Query	</OrgnlBizQry>
End of Message Header	</MsgHdr>
BusinessReportOrErrorChoice	<RptOrErr>
BusinessReport	<BizRpt>
CurrentReservation	<CurRsvatn>
Reservationidentification	<RsvatnId>
ReservationType	<Tp>
ReservationTypeCode	<Cd>UPAR</Cd>
End of ReservationType	</Tp>
Account Owner	<AcctOwnr>
Financial Institution Identification	<FinInstnId>
BICFIIdentifier	<BICFI>DEUTDEFFXXX</BICFI>
End of Financial Institution Identification	</FinInstnId>
End of Account owner	</AcctOwnr>
End of Reservationidentification	</RsvatnId>
Reservation or Error choice	<RsvatnOrErr>
Amount	<Amt>
Amount without currency	<AmtWthtCcy>3000000.00</AmtWthtCcy>
End of Amount	</Amt>
ReservationStatus	<Sts>
ReservationTypeCode	<Cd>ENAB</Cd>
End of ReservationStatus	</Sts>
End of Reservation	</Rsvatn>
End of Reservation or Error choice	</RsvatnOrErr>
End of CurrentReservation	</CurRsvatn>
CurrentReservation	<CurRsvatn>
Reservationidentification	<RsvatnId>
ReservationType	<Tp>
ReservationTypeCode	<Cd>HPAR</Cd>
End of ReservationType	</Tp>
Account Owner	<AcctOwnr>
Financial Institution Identification	<FinInstnId>
BICFIIdentifier	<BICFI>DEUTDEFFXXX</BICFI>
End of Financial Institution Identification	</FinInstnId>
End of Account owner	</AcctOwnr>
End of Reservationidentification	</RsvatnId>
Reservation or Error choice	<RsvatnOrErr>
Reservation	<Rsvatn>
Amount	<Amt>
Amount without currency	<AmtWthtCcy>7000000.00</AmtWthtCcy>
End of Amount	</Amt>
ReservationStatus	<Sts>
ReservationTypeCode	<Cd>ENAB</Cd>
End of ReservationStatus	</Sts>

End of Reservation	</Rsvatn>
End of Reservation or Error choice	</RsvatnOrErr>
End of CurrentReservation	</CurRsvatn>
DefaultReservation	<DfltRsvatn>
Reservationidentification	<RsvatnId>
ReservationType	<Tp>
ReservationTypeCode	<Cd>UPAR</Cd>
End of ReservationType	</Tp>
Account Owner	<AcctOwnr>
Financial Institution Identification	<FinInstnId>
BICFIIdentifier	<BICFI>DEUTDEFFXXX</BICFI>
End of Financial Institution Identification	</FinInstnId>
End of Account owner	</AcctOwnr>
End of Reservationidentification	</RsvatnId>
Reservation or Error choice	<RsvatnOrErr>
Reservation	<Rsvatn>
Amount	<Amt>
Amount without currency	<AmtWthtCcy>5000000.00</AmtWthtCcy>
End of Amount	</Amt>
End of Reservation	</Rsvatn>
End of Reservation or Error choice	</RsvatnOrErr>
End of DefaultReservation	</DfltRsvatn>
DefaultReservation	<DfltRsvatn>
Reservationidentification	<RsvatnId>
ReservationType	<Tp>
ReservationTypeCode	<Cd>HPAR</Cd>
End of ReservationType	</Tp>
Account Owner	<AcctOwnr>
Financial Institution Identification	<FinInstnId>
BICFIIdentifier	<BICFI>DEUTDEFFXXX</BICFI>
End of Financial Institution Identification	</FinInstnId>
End of Account owner	</AcctOwnr>
End of Reservationidentification	</RsvatnId>
Reservation or Error choice	<RsvatnOrErr>
Reservation	<Rsvatn>
Amount	<Amt>
Amount without currency	<AmtWthtCcy>4000000.00</AmtWthtCcy>
End of Amount	</Amt>
End of Reservation	</Rsvatn>
End of Reservation or Error choice	</RsvatnOrErr>
End of DefaultReservation	</DfltRsvatn>
End of BusinessReport	</BizRpt>
End of BusinessReportOrErrorChoice	</RptOrErr>
End of message name for ReturnReservation	</RtrRsvatn>

6. 4.26 ReturnSequence

SSP Proprietary Messages

ReturnSequence_PM

Scope: The ReturnSequence message is used to return information about the level out sequence to fund debit balances on single accounts.

The group of accounts manager chooses the sequence of the accounts how they are used to fund debit balances on single accounts. There exist no level out sequence for sub accounts - they are balanced together with the corresponding RTGS account.

The connected request is performed by a GetSequence message.

<camt.998.001.xx>

Structure:

Name Proprietary message	<PrtryMsg>
Message Header	<MsgHdr>
Message Identification	<MsgId></MsgId>
End of Message Header	</MsgHdr>
Related	<Rltd>
Reference	<Ref></Ref>
End of Related	</Rltd>
Proprietary Data	<PrtryData>
Proprietary Data type	<Tp>ReturnSequence</Tp>
Proprietary Data	<Data>
SSP Proprietary Data	<SspPrtryDt>
Choice	xorBizRptOprlErr
BusinessReport	<BizRpt>
sequence report	<SqncRpt>
sequence identification	<SqncId>
Account Owner	<AcctOwnr></AcctOwnr>
End sequence identification	</SqncId>
sequence details	<SqncDtls>
Member Participant BIC	<Mmbr>
BIC	<BIC></BIC>
End member Participant BIC	</Mmbr>
sequence	<Sqnc></Sqnc>
End sequence details	</SqncDtls>
End sequence report	</SqncRpt>
End of BusinessReport	</BizRpt>
OperationalError	<OprlErr>
Error handling	<Err>
Proprietary error code	<Prtry></Prtry>
End error handling	</Err>
Description	<Desc></Desc>
End of Operational Error	</OprlErr>
End choice	/xorBizRptOprlErr
End of SSP Proprietary Data	</SspPrtryDt>
End of Proprietary Data	</Data>
End of Proprietary Data	</PrtryData>
End proprietary message	</PrtryMsg>

Attributes:

name of attribute	format	short description	description
<PrtryMsg>		Name Proprietary message Mandatory A2A	Validation:
<MsgHdr>		Message Header Mandatory A2A	Set of characteristics specific to the message Message Reference Validation: [1..1]
<MsgId>-</MsgId>	35x	Message Identification Mandatory A2A	Message Identification Validation: [1..1]
</MsgHdr>		End of Message Header Mandatory A2A	Validation: [1..1]
<Rltd>		Related Mandatory A2A	References a previously received message. Validation: [1..1]
<Ref>-</Ref>	35x	Reference Mandatory A2A	Unique and unambiguous reference Message identification of the related GetSequence request. Validation: [1..1]
</Rltd>		End of Related Mandatory A2A	End of Related Validation: [1..1]
<PrtryData>		Proprietary Data Mandatory A2A	Proprietary Data Validation: [1..1]
<Tp>-</Tp>		Proprietary Data type Mandatory A2A	Proprietary Data type here only ReturnSequence is possible Validation: [1..1]
<Data>		Proprietary Data Mandatory A2A	Proprietary data content Validation: [1..1]
<SspPrtryDt>		SSP Proprietary Data Mandatory A2A	Root element for all SSP proprietary data Validation: [1..1]
xorBizRptOprlErr		Choice Mandatory	Validation:

name of attribute	format	short description	description
<BizRpt>		BusinessReport	BusinessReport
		Mandatory	Validation:
		A2A	[1..1]
<SqncRpt>		sequence report	free format tag
		Mandatory	Validation:
		A2A	[1..1]
<Sqncld>		sequence identification	free format tag
		Mandatory	Validation:
		A2A	[1..1]
<AcctOwnr>-</AcctOwnr>	11x	Account Owner	BICIdentifier
			e.g. needed on behalf of third parties if e. g. the NCB are able to start several transactions on behalf their national banking community.
			BIC of the GoA manager (virtual account) / in case if the CB is acting on behalf, the GoA manager she is responsible for
		Mandatory	Validation:
		A2A	[1..1]
</Sqncld>		End sequence identification	free format tag
		Mandatory	Validation:
		A2A	[1..1]
<SqncDtls>		sequence details	free format tag
		Mandatory	Validation:
		A2A	[1..n]
<Mmbr>		Member Participant BIC	free format tag
		Mandatory	Validation:
		A2A	[1..1]
<BIC>-</BIC>	11x	BIC	BICIdentifier
			Code allocated to financial institutions by the Registration Authority, under an international identification scheme, as described in the latest version of the standard ISO 9362 "Banking - Banking telecommunication messages - Bank Identifier Codes". SWIFT is the Registration Authority for ISO 9362.
			BIC of the participant (RTGS account) which belongs to the group of accounts
		Mandatory	Validation:
		A2A	[1..1]
</Mmbr>		End member Participant BIC	free format tag
		Mandatory	Validation:
		A2A	[1..1]
<Sqnc>-</Sqnc>		sequence	free format tag level out sequence number (rank for levelling out)
		Mandatory	Validation:
		A2A	[1..1]

name of attribute	format	short description	description
</SqncDtIs>		End sequence details	free format tag
		Mandatory	Validation: [1..1]
		A2A	
</SqncRpt>		End sequence report	free format tag
		Mandatory	Validation: [1..1]
		A2A	
</BizRpt>		End of BusinessReport	End of BusinessReport
		Mandatory	Validation: [1..1]
		A2A	
<OprlErr>		OperationalError	Indicates an operational error
			Rule description: If BusinessReport is present then OperationalError is not allowed. If BusinessReport is not present, then OperationalError is mandatory.
		Mandatory	Validation: [1..1]
		A2A	
<Err>		Error handling	
		Mandatory	Validation: [1..1]
		A2A	
<Prtry></Prtry>	4x	Proprietary error code	Specification of the error, in free format.
		Mandatory	Validation: [1..1]
		A2A	
</Err>		End error handling	
		Mandatory	Validation: [1..1]
		A2A	
<Desc></Desc>	140x	Description	
		Optional	Validation: [0..1]
		A2A	
</OprlErr>		End of Operational Error	End of Operational Error
		Mandatory	Validation: [1..1]
		A2A	
/xorBizRptOprlErr		End choice	Rule description: If BusinessReport is present then OperationalError is not allowed. If BusinessReport is not present, then OperationalError is mandatory.
		Mandatory	Validation: [1..1]
</SspPrtryDt>		End of SSP Proprietary Data	End of SSP Proprietary Data
		Mandatory	Validation: [1..1]
		A2A	
</Data>		End of Proprietary Data	
		Mandatory	Validation: [1..1]
		A2A	
</PrtryData>		End of Proprietary Data	End of Proprietary Data

name of attribute	format	short description	description
		Mandatory A2A	Validation: [1..1]
</PrtryMsg>		End proprietary message Mandatory A2A	Validation:

Error Codes:

ReturnSequence_PM_1

Scope:

Name Proprietary message	<PrtryMsg>
Message Header	<MsgHdr>
Message Identification	<MsgId>ABC123</MsgId>
End of Message Header	</MsgHdr>
Related	<Rltd>
Reference	<Ref>123ABC</Ref>
End of Related	</Rltd>
Proprietary Data	<PrtryData>
Proprietary Data type	<Tp>ReturnSequence</Tp>
Proprietary Data	<Data>
SSP Proprietary Data	<SspPrtryDt>
BusinessReport	<BizRpt>
sequence report	<SqncRpt>
sequence identification	<SqncId>
Account Owner	<AcctOwnr>DEUTDEFF</AcctOwnr>
End sequence identification	</SqncId>
sequence details	<SqncDtls>
Member Participant BIC	<Mmbr>
BIC	<BIC>DEUTDE2H264</BIC>
End member Participant BIC	</Mmbr>
sequence	<Sqnc>1</Sqnc>
End sequence details	</SqncDtls>
sequence details	<SqncDtls>
Member Participant BIC	<Mmbr>
BIC	<BIC>DEUTDE8C871</BIC>
End member Participant BIC	</Mmbr>
sequence	<Sqnc>2</Sqnc>
End sequence details	</SqncDtls>
End sequence report	</SqncRpt>
End of BusinessReport	</BizRpt>
End of SSP Proprietary Data	</SspPrtryDt>
End of Proprietary Data	</Data>
End of Proprietary Data	</PrtryData>
End proprietary message	</PrtryMsg>

6. 4.27 ReturnSettlementInformation (for CBs only)

SSP Proprietary Messages

ReturnSettlementInformation_PM

Scope: The ReturnSettlementInformation message is used to return more detailed information related to a booking reported in ReturnTransaction. For debtor and creditor side following information will be returned:

- BIC
- Account ID (in case of booking on sub accounts)
- Country code of the responsible CB
- Name of the Group of Accounts (if the account owner is member of a Virtual Account)

The connected request is performed by a GetSettlementInformation message.

<camt.998.001.xx>

Structure:

Name Proprietary message	<PrtryMsg>
Message Header	<MsgHdr>
Message Identification	<MsgId></MsgId>
End of Message Header	</MsgHdr>
Related	<Rltd>
Reference	<Ref></Ref>
End of Related	</Rltd>
Proprietary Data	<PrtryData>
Proprietary Data type	<Tp>ReturnSettlementInformation</Tp>
Proprietary Data	<Data>
SSP Proprietary Data	<SspPrtryDt>
choice	xorBizRptOpriErr
BusinessReport	<BizRpt>
TransactionReport	<TxRpt>
InstructionReference	<InstrRef>
Proprietary Reference	<PrtryRef></PrtryRef>
End of InstructionReference	</InstrRef>
Transaction	<Tx>
Creditor	<Cdtr>
Simple Identification Information	<DmstAcct>
Identification	<Id></Id>
End of simple Identification Information	</DmstAcct>
BIC	<BIC></BIC>
Account Group	<AcctGr>
Simple Identification Information	<DmstAcct>
Identification	<Id></Id>
End of simple Identification Information	</DmstAcct>
End of Account Group	</AcctGr>
Account Central Bank	<AcctCB>
CountryIdentification	<Ctry></Ctry>
End account Central Bank	</AcctCB>
End of Creditor	</Cdtr>
Debtor	<Dbtr>
Simple Identification Information	<DmstAcct>
Identification	<Id></Id>
End of simple Identification Information	</DmstAcct>
BIC	<BIC></BIC>
Account Group	<AcctGr>
Simple Identification Information	<DmstAcct>
Identification	<Id></Id>

End of simple Identification Information	</DmstAcct>
End of Account Group	</AcctGr>
Account Central Bank	<AcctCB>
CountryIdentification	<Ctry></Ctry>
End account Central Bank	</AcctCB>
End of debtor	</Dbtr>
End ofTransaction	</Tx>
End of Transaction Report	</TxRpt>
End of BusinessReport	</BizRpt>
OperationalError	<OpriErr>
Error handling	<Err>
Proprietary error code	<Prtry></Prtry>
End error handling	</Err>
Description	<Desc></Desc>
End of Operational Error	</OpriErr>
End choice	/xorBizRptOpriErr
End of SSP Proprietary Data	</SspPrtryDt>
End of Proprietary Data	</Data>
End of Proprietary Data	</PrtryData>
End proprietary message	</PrtryMsg>

Attributes:

name of attribute	format	short description	description
<PrtryMsg>		Name Proprietary message Mandatory A2A	Validation:
<MsgHdr>		Message Header Mandatory A2A	Set of characteristics specific to the message Message Reference Validation: [1..1]
<MsgId>-</MsgId>	35x	Message Identification Mandatory A2A	Message Identification Validation: [1..1]
</MsgHdr>		End of Message Header Mandatory A2A	Validation: [1..1]
<Rltd>		Related Mandatory A2A	References a previously received message. Validation: [1..1]
<Ref>-</Ref>	35x	Reference Mandatory A2A	Unique and unambiguous reference Validation: [1..1]
</Rltd>		End of Related Mandatory A2A	End of Related Message Identification of the initiating Get Message (here GetSettlementInformation) Validation: [1..1]
<PrtryData>		Proprietary Data Mandatory A2A	Proprietary Data Validation: [1..1]
<Tp>-</Tp>		Proprietary Data type Mandatory A2A	Proprietary Data type here only ReturnSettlementInformation is possible Validation: [1..1]
<Data>		Proprietary Data Mandatory	Proprietary data content Validation: [1..1]
<SspPrtryDt>		SSP Proprietary Data Mandatory A2A	Root element for all SSP proprietary data Validation: [1..1]
xorBizRptOpriErr		choice	choice amongst BizRpt und OpriErr Rule description: If BusinessReport is present then OperationalError is not allowed. If BusinessReport is not present, then OperationalError is mandatory.

name of attribute	format	short description	description
		Mandatory	Validation:
<BizRpt>		BusinessReport	BusinessReport
		Mandatory	Validation:
		A2A	[1..1]
<TxRpt>		TransactionReport	
		Mandatory	Validation:
		A2A	[1..1]
<InstrRef>		InstructionReference	InstructionReference
		Mandatory	Validation:
		A2A	[1..1] only PrtryRef is used
<PrtryRef>-</PrtryRef>	43x	Proprietary Reference	SSP Booking ID (generated by PM 16x; unique and unambiguous identifier of a booking - is delivered within every ReturnTransaction message)
		Mandatory	Validation:
		A2A	[1..1]
</InstrRef>		End of InstructionReference	
		Mandatory	Validation:
		A2A	[1..1]
<Tx>		Transaction	Requested information on the payment.
		Mandatory	Validation:
		A2A	[1..1]
<Cdtr>		Creditor	Provides details about a system and about a member of a system.
		Mandatory	Validation:
		A2A	[1..1]
<DmstAcct>		Simple Identification Information	Simple Identification Information
		Optional	Credit Account Sub Account Number
		A2A	Validation: [0..1]
<Id>-</Id>	34x	Identification	Name or number assigned by an entity to enable recognition of that entity, eg, account identifier.
		Mandatory	Validation:
		A2A	[1..1]
</DmstAcct>		End of simple Identification Information	
		Optional	Validation:
		A2A	[0..1]
<BIC>-</BIC>	4!a2!a2!c3!c	BIC	A code allocated to a financial institution by a Registration Authority under an international identification scheme, as described in the latest edition of the international standard ISO 9362 "Banking - Banking telecommunication messages - Bank identifier codes".
			Credit Account Holder BIC
		Mandatory	Validation:
		A2A	[1..1]

name of attribute	format	short description	description
<AcctGr>		Account Group	Account Group in SSP
		Optional	Validation:
		A2A	[0..1]
<DmstAcct>		Simple Identification Information	Simple Identification Information
		Optional	Credit Group of Account ID of Virtual Account Validation:
		A2A	[0..1]
<Id>-</Id>	34x	Identification	Name or number assigned by an entity to enable recognition of that entity, eg, account identifier.
		Mandatory	Validation:
		A2A	[1..1]
</DmstAcct>		End of simple Identification Information	
		Optional	Validation:
		A2A	[0..1]
</AcctGr>		End of Account Group	end account group
		Optional	Validation:
		A2A	[0..1]
<AcctCB>		Account Central Bank	Account Central Bank
		Mandatory	Validation:
		A2A	[1..1]
<Ctry>-</Ctry>	2!c	CountryIdentification	Credit Country Code responsible Central Bank
		Mandatory	Validation:
		A2A	[1..1]
</AcctCB>		End account Central Bank	End account Central Bank
		Mandatory	Validation:
		A2A	[1..1]
</Cdtr>		End of Creditor	
		Mandatory	Validation:
		A2A	[1..1]
<Dbtr>		Debtor	Information about the debtor of a payment.
		Mandatory	Validation:
		A2A	[1..1]
<DmstAcct>		Simple Identification Information	Simple Identification Information
		Optional	Validation:
		A2A	[0..1]
<Id>-</Id>	34x	Identification	Name or number assigned by an entity to enable recognition of that entity, eg, account identifier.
			Debit Sub Account Number
		Mandatory	Validation:
		A2A	[1..1]
</DmstAcct>		End of simple Identification	

name of attribute	format	short description	description
		Information Optional A2A	Validation: [0..1]
<BIC>-</BIC>	4!a2!a2!c3!c	BIC	A code allocated to a financial institution by a Registration Authority under an international identification scheme, as described in the latest edition of the international standard ISO 9362 "Banking - Banking telecommunication messages - Bank identifier codes". Debit Account Holder BIC
		Mandatory A2A	Validation: [1..1]
<AcctGr>		Account Group	Account Group in SSP
		Optional A2A	Validation: [0..1]
<DmstAcct>		Simple Identification Information Optional A2A	Simple Identification Information Debit Group of Accounts ID of Virtual Account Validation: [0..1]
<Id>-</Id>	34x	Identification Mandatory A2A	Name or number assigned by an entity to enable recognition of that entity, eg, account identifier. Validation: [1..1]
</DmstAcct>		End of simple Identification Information Optional A2A	Validation: [0..1]
</AcctGr>		End of Account Group Optional A2A	end account group Validation: [0..1]
<AcctCB>		Account Central Bank Mandatory A2A	Account Central Bank Validation: [1..1]
<Ctry>-</Ctry>	2!c	CountryIdentification Mandatory A2A	Debtor Country Code Responsible Central Bank Validation: [1..1]
</AcctCB>		End account Central Bank Mandatory A2A	End account Central Bank Validation: [1..1]
</Dbtr>		End of debtor Mandatory A2A	Validation: [1..1]
</Tx>		End ofTransaction Mandatory A2A	Validation: [1..1]

name of attribute	format	short description	description
</TxRpt>		End of Transaction Report	End of Transaction Report
		Mandatory	Validation: [1..1]
		A2A	
</BizRpt>		End of BusinessReport	
		Mandatory	Validation: [1..1]
		A2A	
<OprlErr>		OperationalError	Rule rationale: The message will contain either the information matching the search criteria of the related Get message or an error indication. Rule description: If BusinessReport is present then OperationalError is not allowed. If BusinessReport is not present, then OperationalError is mandatory. Separate Specification see UDFS books regarding error codes
		Mandatory	Validation: [1..1]
		A2A	
<Err>		Error handling	
		Mandatory	Validation: [1..1]
		A2A	
<Prtry>-</Prtry>	4x	Proprietary error code	Specification of the error, in free format.
		Mandatory	Validation: [1..1]
		A2A	
</Err>		End error handling	
		Mandatory	Validation: [1..1]
		A2A	
<Desc>-</Desc>	140x	Description	Specification of the error, in free format.
		Optional	Validation: [0..1]
		A2A	
</OprlErr>		End of Operational Error	End of Operational Error
		Mandatory	Validation: [1..1]
		A2A	
/xorBizRptOprlErr		End choice	Rule description: If BusinessReport is present then OperationalError is not allowed. If BusinessReport is not present, then OperationalError is mandatory.
		Mandatory	Validation: End choice amongst BusinessReport <BizRpt> OperationalError <OprlErr>
</SspPrtryDt>		End of SSP Proprietary Data	End of Root element for all SSP proprietary data
		Mandatory	Validation: [1..1]
		A2A	
</Data>		End of Proprietary Data	
		Mandatory	Validation: [1..1]

name of attribute	format	short description	description
</PrtryData>		End of Proprietary Data Mandatory A2A	End of Proprietary Data Validation: [1..1]
</PrtryMsg>		End proprietary message Mandatory A2A	Validation:

Error Codes:

ReturnSettlementInformation_PM_1

Scope: Sample ReturnSettlementInformation

Name Proprietary message	<PrtryMsg>
Message Header	<MsgHdr>
Message Identification	<MsgId>ABC123</MsgId>
End of Message Header	</MsgHdr>
Related	<Rltd>
Reference	<Ref>123ABC</Ref>
End of Related	</Rltd>
Proprietary Data	<PrtryData>
Proprietary Data type	<Tp>ReturnSettlementInformation</Tp>
Proprietary Data	<Data>
SSP Proprietary Data	<SspPrtryDt>
BusinessReport	<BizRpt>
TransactionReport	<TxRpt>
InstructionReference	<InstrRef>
Proprietary Reference	<PrtryRef>12365</PrtryRef>
End of InstructionReference	</InstrRef>
Transaction	<Tx>
Creditor	<Cdtr>
Simple Identification Information	<DmstAcct>
Identification	<Id>BE671234567891011121314</Id>
End of simple Identification Information	</DmstAcct>
BIC	<BIC>DEUTDEFFXXX</BIC>
Account Group	<AcctGr>
Simple Identification Information	<DmstAcct>
Identification	<Id>BE671234567891011121314</Id>
End of simple Identification Information	</DmstAcct>
End of Account Group	</AcctGr>
Account Central Bank	<AcctCB>
CountryIdentification	<Ctry>DE</Ctry>
End account Central Bank	</AcctCB>
End of Creditor	</Cdtr>
Debtor	<Dbtr>
Simple Identification Information	<DmstAcct>
Identification	<Id>BE671234567891011121314</Id>
End of simple Identification Information	</DmstAcct>
BIC	<BIC>SOGEFRPPXXX</BIC>
Account Group	<AcctGr>
Simple Identification Information	<DmstAcct>
Identification	<Id>BE671234567891011121314</Id>
End of simple Identification Information	</DmstAcct>
End of Account Group	</AcctGr>
Account Central Bank	<AcctCB>
CountryIdentification	<Ctry>FR</Ctry>
End account Central Bank	</AcctCB>
End of debtor	</Dbtr>
End of Transaction	</Tx>
End of Transaction Report	</TxRpt>
End of BusinessReport	</BizRpt>
End of SSP Proprietary Data	</SspPrtryDt>

End of Proprietary Data
End of Proprietary Data
End proprietary message

```
| | </Data>  
| | </PrtryData>  
| </PrtryMsg>
```

6. 4.28 ReturnTransaction

Cash Management Standard

ReturnTransaction_PM

Scope: The ReturnTransaction message is used to return information about debited and/or credited payments of a direct PM participant.

The connected request is performed by a GetTransaction message. If the query type "CHNG", "MODF" or "DELD" is used this indicates a delta set request. The reported information is reduced to the changes (relatively to previous responses with the same QueryName) in the payment queue. For detailed information please check chapter 2.7.

<camt.006.001.xx>

Structure:

Message name for Return Transaction	<RtrTx>
Message Header	<MsgHdr>
Message Identification	<MsgId></MsgId>
Original Business Query	<OrgnlBizQry>
Message Identification	<MsgId></MsgId>
End of Original Business Query	</OrgnlBizQry>
Name of former Query	<QryNm></QryNm>
End of Message Header	</MsgHdr>
AccountOrOperationalErrorChoice	<RptOrErr>
choice	xorBizRptOprlErr
BusinessReport	<BizRpt>
TransactionReport	<TxRpt>
PaymentIdentification	<PmtId>
ProprietaryId	<PrtryId></PrtryId>
EndPaymentIdentification	</PmtId>
TransactionOrErrorChoice	<TxOrErr>
Transaction	<Tx>
PaymentTo	<PmtTo>
Member Identification	<Mmbld>
Financial Institution Identification	<FinInstnId>
BICFIIdentifier	<BICFI></BICFI>
End of Financial Institution Identification	</FinInstnId>
End of Member Identification	</Mmbld>
End PaymentTo	</PmtTo>
Payment From	<PmtFr>
Member Identification	<Mmbld>
Financial Institution Identification	<FinInstnId>
BICFIIdentifier	<BICFI></BICFI>
End of Financial Institution Identification	</FinInstnId>
End of Member Identification	</Mmbld>
End Payment From	</PmtFr>
Credit Debit Indicator	<CdtDbtInd></CdtDbtInd>
Payment	<Pmt>
MessageIdentification	<MsgId></MsgId>
PaymentStatus	<Sts>
PaymentStatusCode	<Cd>
Choice	xorPdgFnI
Pending	<Pdg></Pdg>
FinalStatus	<FnI></FnI>
End of Choice	/xorPdgFnI

End of PaymentStatusCode												</Cd>
DateTime												<DtTm>
Date Time												<DtTm></DtTm>
End of DateTime												</DtTm>
Reason												<Rsn>
ProprietaryStatusJustification												<PrtryRjctn>
ProprietaryStatusReasonCode												<PrtryStsRsn></PrtryStsRsn>
Reason												<Rsn></Rsn>
End of ProprietaryStatusJustification												</PrtryRjctn>
End of Reason												</Rsn>
End of PaymentStatus												</Sts>
InstructedAmount												<InstdAmt>
Amount without currency												<AmtWthtCcy></AmtWthtCcy>
End Instructed Amount												</InstdAmt>
PaymentMethod												<PmtMtd>
Choice												xorFINMTPtry
FINMessageType												<FINMT></FINMT>
Proprietary type												<Prtry></Prtry>
End of Choice												/xorFINMTPtry
End of Payment Method												</PmtMtd>
Priority												<Prty>
Priority Code												<Cd></Cd>
End Priority												</Prty>
ProcessingValidityTime												<PrcgVldtyTm>
choice												xorFrDtTmToDtTmDtTmRg
FromDateTime												<FrDtTm></FrDtTm>
ToDateTime												<ToDtTm></ToDtTm>
DateTimeRange												<DtTmRg>
FromDateTime												<FrDtTm></FrDtTm>
ToDateTime												<ToDtTm></ToDtTm>
End of DateTimeRange												</DtTmRg>
End of choice												/xorFrDtTmToDtTmDtTmRg
End of ProcessingValidityTime												</PrcgVldtyTm>
InstructionCopy												<InstrCpy></InstrCpy>
Type												<Tp>
ProprietaryPaymentTypeCode												<Prtry></Prtry>
End of Type												</Tp>
TransactionIdentification 16x												<TxId></TxId>
Value date												<IntrBkSttlmDt></IntrBkSttlmDt>
EndToEndIdentification												<EndToEndId></EndToEndId>
Parties												<Pties>
DebtorAgent												<DbtrAgt>
Financial Institution Identification												<FinInstnId>
BICFIIdentifier												<BICFI></BICFI>
End of Financial Institution Identification												</FinInstnId>
End of DebtorAgent												</DbtrAgt>
InstructedReimbursementAgent												<InstdRmbrsmntAgt>
Financial Institution Identification												<FinInstnId>
BICFIIdentifier												<BICFI></BICFI>
End of Financial Institution Identification												</FinInstnId>
End of InstructedReimbursementAgent												</InstdRmbrsmntAgt>
IntermediaryAgent												<IntrmyAgt>

Financial Institution Identification	<FinInstnId>
BICFIIdentifier	<BICFI></BICFI>
End of Financial Institution Identification	</FinInstnId>
End of IntermediaryAgent	</IntrmyAgt>
CreditorAgent	<CdtrAgt>
Financial Institution Identification	<FinInstnId>
BICFIIdentifier	<BICFI></BICFI>
End of Financial Institution Identification	</FinInstnId>
End of CreditorAgent	</CdtrAgt>
Creditor	<Cdtr>
Financial Institution Identification	<FinInstnId>
BICFIIdentifier	<BICFI></BICFI>
End of Financial Institution Identification	</FinInstnId>
End of Creditor	</Cdtr>
End of Parties	</Pties>
End of Payment	</Pmt>
AccountEntry	<AcctNtry>
Account Identification	<Acct>
Identification	<Id>
GenericAccountIdentification	<Othr>
Identification	<Id></Id>
End of GenericAccountIdentification	</Othr>
End Identification	</Id>
End of Account	</Acct>
Entry	<Ntry>
Date	<Dt>
DateTime	<DtTm></DtTm>
End of Date	</Dt>
End of Entry	</Ntry>
End of Account Entry	</AcctNtry>
End ofTransaction	</Tx>
End of TransactionOrErrorChoice	</TxOrErr>
End of Transaction Report	</TxRpt>
End of BusinessReport	</BizRpt>
OperationalError	<OprlErr>
Error handling	<Err>
Proprietary error code	<Prtry></Prtry>
End error handling	</Err>
Description	<Desc></Desc>
End of Operational Error	</OprlErr>
End choice	/xorBizRptOprlErr
End of AccountOrOperationalErrorChoice	</RptOrErr>
End messagename ReturnTransaction	</RtrTx>

Attributes:

name of attribute	format	short description	description
<RtrTx>		Message name for Return Transaction Mandatory A2A	Message name for Return Transaction Validation:
<MsgHdr>		Message Header Mandatory A2A	Set of characteristics specific to the message Validation: [1..1]
<MsgId>-</MsgId>	35x	Message Identification Mandatory A2A	Message Identification Validation: [1..1]
<OrgnBizQry>		Original Business Query Mandatory A2A	Original Business Query, reference to the query Validation: [1..1]
<MsgId>-</MsgId>	35x	Message Identification Mandatory A2A	Message Identification Validation: [1..1]
</OrgnBizQry>		End of Original Business Query Mandatory A2A	End of Original Business Query, reference to the query Validation: [1..1]
<QryNm>-</QryNm>	35x	Name of former Query Optional A2A	Recalls the criteria (search and return criteria) defined in a preceding query [0..1] Reference for the delta set retrieval. Value is generated by ICM Validation: [0..1]
</MsgHdr>		End of Message Header Mandatory A2A	Validation: [1..1]
<RptOrErr>		AccountOrOperationalError Choice Mandatory A2A	Validation: [1..1]
xorBizRptOprlErr		choice Mandatory	choice amongst BizRpt und OprlErr Rule description: If BusinessReport is present then OperationalError is not allowed. If BusinessReport is not present, then OperationalError is mandatory. Validation: choice amongst BusinessReport <BizRpt> OperationalError <OprlErr>
<BizRpt>		BusinessReport	BusinessReport Rule rationale: The message will contain either the information matching the search criteria of the related Get message or an error indication.

name of attribute	format	short description	description
		Mandatory A2A	Rule description: If BusinessReport is present then OperationalError is not allowed. If BusinessReport is not present, then OperationalError is mandatory. Validation: [1..1] <PmtCmonInf> in PM not used
<TxRpt>		TransactionReport Mandatory A2A	Reports either on the transaction information or on a business error. If Transaction is present, then BusinessError is not allowed. If Transaction is not present, then BusinessError is mandatory. Validation: [1..n]
<PmtId>		PaymentIdentification Mandatory A2A	Set of elements to provide further means of referencing a payment transaction Validation: [1..1] in PM only <PrtryRef> = SSP Booking ID (= PM Reference) is delivered as InstrRef. If within the GetTransaction the <LongBizId> is requested as identifier, this information (tags of LngBizId), is filled within the <Pmt> section. The LngBizId is not unambiguous and may refer to several booking entries.
<PrtryId>-</PrtryId>	16n	ProprietaryId Mandatory A2A	ProprietaryId SSP Booking ID (generated by PM [16n]; unique and unambiguous identifier of a booking) Validation: [1..1]
</PmtId>		EndPaymentIdentification Mandatory A2A	End of Set of elements to reference a payment transaction Validation: [1..1]
<TxOrErr>		TransactionOrErrorChoice Mandatory	Validation: [1..1]
<Tx>		Transaction Mandatory A2A	Requested information on the payment. Validation: [1..1] BusinessError is not used
<PmtTo>		PaymentTo Optional A2A	Defines the criteria which are used to search for the destination of the payment. SystemIdentification [0..n] MemberIdentification [0..n] Validation: [0..1]
<Mmbld>		Member Identification Optional A2A	Unique and unambiguous identification of a member within a system, assigned using the member identification scheme of the system Validation: [0..1] in PM only BIC is used

name of attribute	format	short description	description
<FinInstnId>		Financial Institution Identification Mandatory	Financial Institution Identification Validation: [1..1]
<BICFI>-</BICFI>	4!a2!a2!c3!c	BICFIIdentifier Optional A2A	BICFIIdentifier - BIC of the Receiver - In case the payment is addressed to TRGTXPMLVP, then the BIC of first filled field 56A-58A of MT103/MT202 or field 53A of MT204 (= receiving Internet-based participant) - In case of AS XML messages: the BIC of the related AS Validation: [0..1]
</FinInstnId>		End of Financial Institution Identification Mandatory	End of Financial Institution Identification Validation: [1..1]
</Mmbld>		End of Member Identification Optional A2A	Validation: [0..1]
</PmtTo>		End PaymentTo Optional A2A	End PaymentTo Validation: [0..1]
<PmtFr>		Payment From Optional A2A	Defines the criteria which are used to search for the origin of the payment. SystemIdentification [0..n] MemberIdentification [0..n] Validation: [0..1]
<Mmbld>		Member Identification Optional A2A	Unique and unambiguous identification of a member within a system, assigned using the member identification scheme of the system Validation: [0..1] in PM only BIC is used
<FinInstnId>		Financial Institution Identification Mandatory	Financial Institution Identification Validation: [1..1]
<BICFI>-</BICFI>	4!a2!a2!c3!c	BICFIIdentifier Optional A2A	BICFIIdentifier - BIC of the Sender - In case of payments from Internet-based participants sent by PM with technical BIC TRGTXPMLVP, then the BIC of the IBP from field 52A. - In case the booking stems from an AS XML message: BIC of the Sender (AS, CB or SB) Validation: [0..1]
</FinInstnId>		End of Financial Institution Identification Mandatory	End of Financial Institution Identification Validation: [1..1]

name of attribute	format	short description	description
</Mmbld>		End of Member Identification Optional A2A	Validation: [0..1]
</PmtFr>		End Payment From Optional A2A	End Payment From Validation: [0..1]
<CdtDbtInd>		Credit Debit Indicator Optional A2A	Specifies if an operation is an increase or a decrease CRDT = Credit DBIT = Debit Settlement Debits / Credits Validation: [0..1] This element will only be returned if the payment search was related to a single account but not if both debit and credit booking is related to that account.
<Pmt>		Payment Optional A2A	Information about the payment and, possibly, its related charges. Validation: [0..1]
<MsgId>-</MsgId>	16n	MessageIdentification Optional A2A	SSP Business Case ID The business case reference enables the customer to link all booking entries stemming from this business case. Validation: [0..1] differs from the cash management standard
<Sts>		PaymentStatus Optional A2A	Validation: [0..1]
<Cd>		PaymentStatusCode Optional A2A	Payment Status Range of values in PM pending (queued, accounting stopped due to stop sending) final (closed normal) noted (earmarked) revoked rejected Validation: [0..1]
xorPdgFnl		Choice Mandatory	Choice between Pending and Final status choice amongst <Pdg>, <Fnl> Validation:
<Pdg>-</Pdg>	4!c	Pending Mandatory A2A	Pending Status Code of the payment Validation: [1..1] in PM only STLE= earmarked, PSTL = Pending, ACPD = warehoused and STLM = information period (AS payment during information period) are used.
<Fnl>-</Fnl>		FinalStatus Mandatory A2A	Validation: [1..1] in PM only CAND = Revoked, STLD = by means of final, RJTD = Rejected are used

name of attribute	format	short description	description
/xorPdgFnl		End of Choice Mandatory	Validation:
</Cd>		End of PaymentStatusCode Optional A2A	Validation: [0..1]
<DtTm>		DateTime Optional A2A	A specified date and time. Settlement time Validation: [0..1]
<DtTm>-</DtTm>	ISODateTime	Date Time Mandatory A2A	Validation: [1..1]
</DtTm>		End of DateTime Optional A2A	Validation: [0..1]
<Rsn>		Reason Optional A2A	Validation: [0..1]only ProprietaryStatusJustification used in PM
<PrtryRjctn>		ProprietaryStatusJustification Mandatory A2A	Validation: [1..1]
<PrtryStsRsn>-</PrtryStsRsn> 4x		ProprietaryStatusReasonCode Mandatory A2A	ProprietaryStatusReasonCode SSP Error Code for RJTD payments Validation: [1..1]
<Rsn>-</Rsn>	256x	Reason Mandatory A2A	Reason Error text. Validation: [1..1]
</PrtryRjctn>		End of ProprietaryStatusJustification Mandatory A2A	Validation: [1..1]
</Rsn>		End of Reason Optional A2A	Validation: [0..1]
</Sts>		End of PaymentStatus Optional A2A	Validation: [0..1]
<InstdAmt>		InstructedAmount Optional	Specifies the instructed amount(s) on which the query is performed. Amount Validation:

name of attribute	format	short description	description
		A2A	[0..1] In PM only 2 fraction digits are allowed
<AmtWthtCcy>-</AmtWthtCcy>	18n	Amount without currency	Number of monetary units specified in a currency where the unit of currency is implied by the context. The integer part of Amount must contain at least one digit. The decimal separator is a dot '.'. It is not mandatory but included in the maximum length. The number of digits following the dot must not exceed the maximum number allowed for that specific currency as specified in ISO 4217. Mandatory Validation: [1..1] In PM only 2 fraction digits are possible
</InstdAmt>		End Instructed Amount	End Instructed Amount Optional Validation: [0..1]
<PmtMtd>		PaymentMethod	Indicates the message or event from which an instruction has been initiated. FINMessageType [1..1] XMLMessageName [1..1] Proprietary [1..1] Instrument [1..1] Optional Validation: [0..1] PM only uses <FINMT> and <Prtry>.
xorFINMTPrtry		Choice	Choice amongst <FINMT> and <Prtry> Mandatory Validation:
<FINMT>-</FINMT>	3x	FINMessageType	possible values: 103 202 204 FINMT Message-Type Mandatory Validation: [1..1] It is used to specify a SWIFT FIN message. Possible values are: 202 (MT202), 103 (MT103 and MT103+) or 204 (MT204).
<Prtry>-</Prtry>	35x	Proprietary type	Proprietary type of payment origin Only the values ASXML, T2SXML, TIPSXML, INTERN, ORDER and T2SXML are possible: ASXML: all bookings stemming from an incoming AS XML payments (incl. SBTransferInitiation). T2SXML: all bookings stemming from an incoming T2S XML payment INTERN: all bookings stemming from internal messages: - Automatic processing by PM, including Standing Orders - Payments delivered from HAM (e.g. Simplified MT202), RM, SF, CRISP, CM ORDER: all bookings stemming from current orders sent via ICM. (E.g. Backup Payments. - But not SBTransferInitiation.) T2SXML: all bookings stemming from LiquidityCreditTransfer and LiquidityDebitTransfer XML messages related to transfers with T2S. Mandatory Validation: [1..1]
/xorFINMTPrtry		End of Choice	Mandatory Validation:

name of attribute	format	short description	description
</PmtMtd>		End of Payment Method	End of Payment Method
		Optional	Validation:
		A2A	[0..1]
<Prty>		Priority	The relative urgency or order of importance that the originator would like the recipient of the payment instruction to apply to the processing of the payment instruction.
			Code [1..1] PriorityCode PriorityCodeChoice
			ProprietaryCode [1..1] Max4AlphaNumericText
		Optional	Validation:
		A2A	[0..1]
<Cd>-</Cd>		Priority Code	Specifies the priority level of an event.
			HIGH = High Priority level is high.
			LOWW = Low Priority level is low.
			NORM = Normal Priority level is normal.
			Priority
		Mandatory	Validation:
		A2A	[1..1] here only PriorityCode is used
			Normal = NORM is defined in SSP as = urgent Priority High = HIGH is defined in SSP as = highly urgent Priority Low = LOWW is defined in SSP as = normal Priority
</Prty>		End Priority	End Priority
		Optional	Validation:
		A2A	[0..1]
<PrcgVldtyTm>		ProcessingValidityTime	Date and time range within which the payment instruction must be processed.
			Timed payments: Timed Payments Earliest and Latest Debit Time
		Optional	Validation:
		A2A	[0..1]
xorFrDtTmToDtTmDtTmRg		choice	choice amongst <FrDtTm>, <ToDtTm> or <DtTmRg>
		Mandatory	Validation:
<FrDtTm>-</FrDtTm>	ISODateTime	FromDateTime	Date and time at which the range starts.
		Mandatory	Validation:
		A2A	[1..1]
<ToDtTm>-</ToDtTm>	ISODateTime	ToDateTime	Date and time at which the range ends.
		Mandatory	Validation:
		A2A	[1..1]
<DtTmRg>		DateTimeRange	Range of time between a start date and time and an end date and time.
		Mandatory	Validation:

name of attribute	format	short description	description
		A2A	[1..1]
<FrDtTm>-</FrDtTm>	ISODateTime	FromDateTime	Date and time at which the range starts.
		Mandatory	Validation:
		A2A	[1..1]
<ToDtTm>-</ToDtTm>	ISODateTime	ToDateTime	Date and time at which the range ends.
		Mandatory	Validation:
		A2A	[1..1]
</DtTmRg>		End of DateTimeRange	
		Mandatory	Validation:
		A2A	[1..1]
/xorFrDtTmToDtTmDtTmRg		End of choice	end of choice amongst <FrDtTm>, or <ToDtTm> or <DtTmRg>
		Mandatory	Validation:
</PrcgVldtyTm>		End of ProcessingValidityTime	End of ProcessingValidityTime
		Optional	Validation:
		A2A	[0..1]
<InstrCpy>-</InstrCpy>	10000x	InstructionCopy	Copy of the original instruction, in free form text.
			could be used to pass back the complete copy of the payment message (SWIFT FIN string of the selected message including Header and Trailer or internal message or XML message) both in an unformatted structure. In case of receiving an original XML message, SSP use a CDATA section, so that the text will be ignored by the parser, with the effect, that the markup sings <> will be ignored too. From a technical point of view it seems to be a string. The client A2A application have to unpack this CDATA section.
			This will look as follows: <InstrCpy><![CDATA[<Document xmlns="urn:swift:xsd:pain.998.001.01"><pain.998.001.01><PrtryDt><Tp>ASTransferInitiation</Tp> ...</PrtryDt></pain.998.001.01></Document>]]></InstrCpy>
			In case of internal message (Payment data generated by PM or Data provided by the interface from HAM, RM, SF, CRISP, CM, ICM) following information will be displayed: PM reference: <content> TRN: <content> Related TRN (field21): <content> Sender: <content> Receiver: <content> Amount: <content> (without decimal point, displayed as Eurocent) Payment Type: <content> Execution Date: <content> BIC 52: <content> BIC 53: <content> BIC 58: <content> Field 72: <content> SSP Error Code: <content> If a field is not filled or not available, then the label will be displayed without content.
			Sample for internal structure: <InstrCpy>PM Reference: 189300TRN: 000000000189300Related TRN (F21): 000000000189300Sender: ZYBMDEF0MD1Receiver: ZYBMDEF0MCBAmount: 12300Payment Type: Liquidity transferExecution Date: 2007-05-16T00:00:00+02:00BIC 52: ZYBMDEF0MD1BIC 53: ZYBMDEF0MCBBIC 58: ZYBMDEF0MD1F72: </InstrCpy>
		Optional	Validation:

name of attribute	format	short description	description
		A2A	[0..1]*****differs from the Cash management standard (enlargend by SWIFT to 20000 text)
<Tp>		Type	Payment Type
		Optional	Validation: [0..1]
		A2A	
<Prtry>-</Prtry>		ProprietaryPaymentTypeCode	Proprietary Payment Type REGP = Regular Payment CONP = Connected Payment BACP = Backup Payment LIQP = Liquidity transfer via payments ASYP = Ancillary Systems Payments MANP= mandated payment INTP = interests PDDB = penalties BIDB = billing T2SL = T2S transactions TIPS = TIPS transactions Type of Payment
		Mandatory	Validation: [1..1] in PM only Proprietary Payment Type is used
		A2A	
</Tp>		End of Type	End of Payment Type
		Optional	Validation: [0..1]
		A2A	
<Txld>-</Txld>	16x	TransactionIdentification 16x	Unique and unambiguous identification of a payment transaction, as assigned by the originator. The payment transaction reference is used for reconciliation or to link tasks relating to the payment transaction. Instruction Identification - TRN in case of a FIN payment - InstructionIdentification in case of AS XML payments
		Optional	Validation: [0..1]
		A2A	
<IntrBkSttlmDt>-</IntrBkSttlmDt>	ISODate	Value date	Value date Execution Date current and future (5 future dates are possible) / Value Date If Value Date Check was deactivated, a past Value date in tag < IntrBkSettlDt > is possible.
		Optional	Validation: [0..1]
		A2A	
<EndToEndId>-</EndToEndId>	16x	EndToEndIdentification	Unique and unambiguous identification of a payment transaction, as assigned by any of the parties on the initiating side, that will be passed on throughout the entire end-to-end chain End to End Identification - Related TRN (Field 21 in case of FIN messages) - EndToEndIdentification in case of AS XML payments
		Optional	Validation: [0..1] needed because of LngBizId in inside the GetTransaction message clarification SWIFT (max. 16x)
		A2A	
<Pties>		Parties	PaymentTransactionParties needed for selection of Selection SWIFT FIN Fields
		Optional	Validation: [0..1]
		A2A	
<DbtrAgt>		DebtorAgent	First Agent F52, ordering institution in case of FIN payment / or

name of attribute	format	short description	description
		Optional A2A	FirstAgent BIC of AS XML message Validation: [0..1]
<FinInstnId>		Financial Institution Identification Mandatory	Financial Institution Identification Validation: [1..1]
<BICFI>-</BICFI>	4!a2!a2!c3!c	BICFIIdentifier Optional	BICFIIdentifier Validation: [0..1]
</FinInstnId>		End of Financial Institution Identification Mandatory	End of Financial Institution Identification Validation: [1..1]
</DbtrAgt>		End of DebtorAgent Optional	Validation: [0..1]
<InstdRmbrsmntAgt>		InstructedReimbursementAgent Optional A2A	Receivers Correspondent F54, receivers correspondent in case of FIN payment / or Debtor BIC of AS XML message Validation: [0..1]
<FinInstnId>		Financial Institution Identification Mandatory	Financial Institution Identification Validation: [1..1]
<BICFI>-</BICFI>	4!a2!a2!c3!c	BICFIIdentifier Optional	BICFIIdentifier Validation: [0..1]
</FinInstnId>		End of Financial Institution Identification Mandatory	End of Financial Institution Identification Validation: [1..1]
</InstdRmbrsmntAgt>		End of InstructedReimbursementAgent Optional	Validation: [0..1]
<IntrmyAgt>		IntermediaryAgent Optional A2A	Intermediary F56, intermediary institution in case of FIN payment / or AS counterpart BIC (in case of cross-AS settlement) of AS XML message Validation: [0..1]
<FinInstnId>		Financial Institution Identification Mandatory	Financial Institution Identification Validation: [1..1]
<BICFI>-</BICFI>	4!a2!a2!c3!c	BICFIIdentifier	BICFIIdentifier

name of attribute	format	short description	description
		Optional	Validation: [0..1]
</FinInstnId>		End of Financial Institution Identification Mandatory	End of Financial Institution Identification Validation: [1..1]
</IntrmyAgt>		End of IntermediaryAgent Optional	Validation: [0..1]
<CdtrAgt>		CreditorAgent Optional A2A	Final Agent F57, account with institution in case of FIN payment / or FinalAgent BIC of AS XML message Validation: [0..1]
<FinInstnId>		Financial Institution Identification Mandatory	Financial Institution Identification Validation: [1..1]
<BICFI>--</BICFI>	4!a2!a2!c3!c	BICFIIdentifier Optional	BICFIIdentifier Validation: [0..1]
</FinInstnId>		End of Financial Institution Identification Mandatory	End of Financial Institution Identification Validation: [1..1]
</CdtrAgt>		End of CreditorAgent Optional	Validation: [0..1]
<Cdtr>		Creditor Optional A2A	Creditor F58, beneficiary institution in case of FIN payment / or Creditor BIC of AS XML message Validation: [0..1]
<FinInstnId>		Financial Institution Identification Mandatory	Financial Institution Identification Validation: [1..1]
<BICFI>--</BICFI>	4!a2!a2!c3!c	BICFIIdentifier Optional	BICFIIdentifier Validation: [0..1]
</FinInstnId>		End of Financial Institution Identification Mandatory	End of Financial Institution Identification Validation: [1..1]
</Cdtr>		End of Creditor Optional	Validation: [0..1]

name of attribute	format	short description	description
</Pties>		End of Parties	End Selection SWIFT FIN Fields
		Optional A2A	Validation: [0..1]
</Pmt>		End of Payment	End of Payment
		Optional A2A	Validation: [0..1]
<AcctNtry>		AccountEntry	Posting of an item to a cash account, in the context of a cash transaction, that results in an increase or decrease to the balance of the account.
		Optional A2A	Validation: [0..1]
<Acct>		Account Identification	
		Mandatory A2A	Validation: [1..1] in the Cash management standard validated as mandatory, only filled with the information of <PmtFr> or <PmtTo> (information is here not meaningful)
<Id>		Identification	Identification
		Mandatory A2A	Validation: [1..1]
<Othr>		GenericAccountIdentification	GenericAccountIdentification
		Mandatory	Validation: [1..1]
<Id>-</Id>	34x	Identification	Name or number assigned by an entity to enable recognition of that entity, eg, account identifier.
			PM account number (main or sub-account) of the counterpart
			If credit/debit indication was requested (<CdtDbtInd>true</CdtDbtInd>) following rule applies: The indicator is related to the selected account in GetTransaction. This means... - in case of codeword DEBT in <CdtDbtInd> the account mentioned here is the credited account. - in case of codeword CRDT in <CdtDbtInd> the account mentioned here is the debited account.
		Mandatory A2A	Validation: [1..1]
</Othr>		End of GenericAccountIdentification	End of GenericAccountIdentification
		Mandatory	Validation: [1..1]
</Id>		End Identification	End Identification
		Mandatory A2A	Validation: [1..1]
</Acct>		End of Account	
		Mandatory A2A	Validation: [1..1]

name of attribute	format	short description	description
<Ntry>		Entry	Entry in the books. Entry Time
		Optional	Validation:
		A2A	[0..1] in case if the credited or debited account (Acctld) is not identifiable, this tag will be empty.
<Dt>		Date	Date and time choice
		Optional	Validation:
			[0..1]
<DtTm>		DateTime	A specified date and time.
		Mandatory	Validation:
		A2A	[1..1]
</Dt>		End of Date	
		Optional	Validation:
			[0..1]
</Ntry>		End of Entry	
		Optional	Validation:
		A2A	[0..1]
</AcctNtry>		End of Account Entry	End of Account Entry
		Optional	Validation:
		A2A	[0..1]
</Tx>		End of Transaction	End of Transaction
		Mandatory	Validation:
		A2A	[1..1]
</TxOrErr>		End of TransactionOrErrorChoice	
		Mandatory	Validation:
			[1..1]
</TxRpt>		End of Transaction Report	End of Transaction Report
		Mandatory	Validation:
		A2A	[1..n]
</BizRpt>		End of BusinessReport	End of BusinessReport
		Mandatory	Validation:
		A2A	[1..1]
<OprlErr>		OperationalError	Rule rationale: The message will contain either the information matching the search criteria of the related Get message or an error indication. Rule description: If BusinessReport is present then OperationalError is not allowed. If BusinessReport is not present, then OperationalError is mandatory. Separate Specification see UDFS books regarding error codes
		Mandatory	Validation:
		A2A	[1..1]
<Err>		Error handling	

name of attribute	format	short description	description
		Mandatory	Validation:
		A2A	[1..1]
<Prtry>-</Prtry>	4x	Proprietary error code	Specification of the error, in free format.
		Mandatory	Validation:
		A2A	[1..1]
</Err>		End error handling	
		Mandatory	Validation:
		A2A	[1..1]
<Desc>-</Desc>	140x	Description	Specification of the error, in free format.
		Optional	Validation:
		A2A	[0..1]
</OprlErr>		End of Operational Error	End of Operational Error
		Mandatory	Validation:
		A2A	[1..1]
/xorBizRptOprlErr		End choice	Rule description: If BusinessReport is present then OperationalError is not allowed. If BusinessReport is not present, then OperationalError is mandatory.
		Mandatory	Validation:
			End choice amongst BusinessReport <BizRpt> OperationalError <OprlErr>
</RptOrErr>		End of AccountOrOperationalError Choice	
		Optional	Validation:
</RtrTx>		End messagename ReturnTransaction	
		Mandatory	Validation:
		A2A	

Error Codes:

ReturnTransaction_PM_1

Scope: Return Transaction with SSP Booking ID and Payment Details

MessageName for Return Transaction	<RtrTx>
Message Header	<MsgHdr>
Message Identification	<MsgId>ABC123589</MsgId>
Original Business Query	<OrgnlBizQry>
Message Identification	<MsgId>ABCDEFGHIJKLMNQRST12345678</MsgId>
End of Original Business Query	</OrgnlBizQry>
Name of former Query	<QryNm>ABC12345</QryNm>
End of Message Header	</MsgHdr>
AccountOrOperationalErrorChoice	<RptOrErr>
BusinessReport	<BizRpt>
TransactionReport	<TxRpt>
PaymentIdentification	<InstrRef>
ProprietaryId	<PrtryId>12345</PrtryId>
EndPaymentIdentification	</PmtId>
TransactionOrErrorChoice	<TxOrErr>
Transaction	<Tx>
PaymentTo	<PmtTo>
Member Identification	<Mmbld>
Financial Institution Identification	<FinInstnId>
BICFIIdentifier	<BICFI>MARKDEFFXXX</BICFI>
End of Financial Institution Identification	</FinInstnId>
End of Member Identification	</Mmbld>
End PaymentTo	</PmtTo>
Payment From	<PmtFr>
Member Identification	<Mmbld>
Financial Institution Identification	<FinInstnId>
BICFIIdentifier	<BICFI>DRESDEFFXXX</BICFI>
End of Financial Institution Identification	</FinInstnId>
End of Member Identification	</Mmbld>
End Payment From	</PmtFr>
Credit Debit Indicator	<CdtDbtInd>CRDT</CdtDbtInd>
Payment	<Pmt>
MessageIdentification	<MsgId>123</MsgId>
InstructedAmount	<InstdAmt>
Amount without currency	<AmtWthtCcy>500.00</AmtWthtCcy>
End Instructed Amount	</InstdAmt>
PaymentMethod	<PmtMtd>
FINMessageType	<FINMT>103</FINMT>
End of Payment Method	</PmtMtd>
Priority	<Prty>
Priority Code	<Cd>NORM</Cd>
End Priority	</Prty>
Type	<Tp>
ProprietaryPaymentTypeCode	<PrtryPmtTp>REGP</PrtryPmtTp>
End of Type	</Tp>
TransactionIdentification 16x	<TxId>ABC1234</TxId>
Value date	<IntrBkSttlmDt>2007-10-12</IntrBkSttlmDt>
EndToEndIdentification	<EndToEndId>ABC1356</EndToEndId>
Parties	<Pties>

DebtorAgent						<DbtrAgt>
Financial Institution Identification						<FinInstnId>
BICFIIdentifier						<BICFI>DEUTDEFFXXX</BICFI>
End of Financial Institution Identification						</FinInstnId>
End of DebtorAgent						</DbtrAgt>
IntermediaryAgent						<IntrmyAgt>
Financial Institution Identification						<FinInstnId>
BICFIIdentifier						<BICFI>WELADED1XXX</BICFI>
End of Financial Institution Identification						</FinInstnId>
End of IntermediaryAgent						</IntrmyAgt>
CreditorAgent						<CdtrAgt>
Financial Institution Identification						<FinInstnId>
BICFIIdentifier						<BICFI>VOBADESSXXX</BICFI>
End of Financial Institution Identification						</FinInstnId>
End of CreditorAgent						</CdtrAgt>
Creditor						<Cdtr>
Financial Institution Identification						<FinInstnId>
BICFIIdentifier						<BICFI>PBNKDEFFXXX</BICFI>
End of Financial Institution Identification						</FinInstnId>
End of Creditor						</Cdtr>
End of Parties						</PmtTxPty>
End of Payment						</Pmt>
End of Transaction						</Tx>
End of TransactionOrErrorChoice						</TxOrErr>
End of Transaction Report						</TxRpt>
End of BusinessReport						</BizRpt>
End of AccountOrOperationalErrorChoice						</RptOrErr>
End message ReturnTransaction						</RtrTx>

ReturnTransaction_PM_2

Scope: Return Transaction LongBusinessIdentification is requested within the GetTransaction message. LongBusinessInformation (TRN, Amount, Value Date, MessageType, Sender and Receiver, Related Reference) within the Payment Details

MessageName for Return Transaction	<RtrTx>
Message Header	<MsgHdr>
Message Identification	<MsgId>ABCDEFGHIJKLMNQRSTUvwxyzABCDEFGHI</MsgId>
Original Business Query	<OrgnlBizQry>
Message Identification	<MsgId>ABCDEFGHIJKLMNQRST12345678</MsgId>
End of Original Business Query	</OrgnlBizQry>
End of Message Header	</MsgHdr>
AccountOrOperationalErrorChoice	<RptOrErr>
BusinessReport	<BizRpt>
TransactionReport	<TxRpt>
PaymentIdentification	<PmtId>
ProprietaryId	<PrtryId>12345</PrtryId>
EndPaymentIdentification	</PmtId>
TransactionOrErrorChoice	<TxOrErr>
Transaction	<Tx>
PaymentTo	<PmtTo>
Member Identification	<Mmbld>
Financial Institution Identification	<FinInstnId>
BICFIIdentifier	<BICFI>MARKDEFFXXX</BICFI>
End of Financial Institution Identification	</FinInstnId>
End of Member Identification	</Mmbld>
End PaymentTo	</PmtTo>
Payment From	<PmtFr>
Member Identification	<Mmbld>
Financial Institution Identification	<FinInstnId>
BICFIIdentifier	<BICFI>DRESEFFXXX</BICFI>
End of Financial Institution Identification	</FinInstnId>
End of Member Identification	</Mmbld>
End Payment From	</PmtFr>
Payment	<Pmt>
InstructedAmount	<InstdAmt>
Amount without currency	<AmtWthtCcy>100.15</AmtWthtCcy>
End Instructed Amount	</InstdAmt>
PaymentMethod	<PmtMtd>
FINMessageType	<FINMT>202</FINMT>
End of Payment Method	</PmtMtd>
TransactionIdentification 16x	<TxId>ABC1234</TxId>
Value date	<IntrBkSttlmDt>2007-10-12</IntrBkSttlmDt>
EndToEndIdentification	<EndToEndId>ABC12134</EndToEndId>
End of Payment	</Pmt>
End of Transaction	</Tx>
End of TransactionOrErrorChoice	</TxOrErr>
End of Transaction Report	</TxRpt>
End of BusinessReport	</BizRpt>
End of AccountOrOperationalErrorChoice	</RptOrErr>
End messageName ReturnTransaction	</RtrTx>

ReturnTransaction_PM_3

Scope: Return Transaction with SSP Booking ID and different PaymentDetails

MessageName for Return Transaction	<RtrTx>
Message Header	<MsgHdr>
Message Identification	<MsgId>ABCDEFGHIJKLMNQRSTUvwxyzABCDEFGHI</MsgId>
Original Business Query	<OrgnlBizQry>
Message Identification	<MsgId>ABCDEFGHIJKLMNQRST12345678</MsgId>
End of Original Business Query	</OrgnlBizQry>
End of Message Header	</MsgHdr>
AccountOrOperationalErrorChoice	<RptOrErr>
BusinessReport	<BizRpt>
TransactionReport	<TxRpt>
PaymentIdentification	<PmtId>
ProprietaryId	<PrtryId>12345</PrtryId>
EndPaymentIdentification	</PmtId>
TransactionOrErrorChoice	<TxOrErr>
Transaction	<Tx>
PaymentTo	<PmtTo>
Member Identification	<Mmbld>
Financial Institution Identification	<FinInstnId>
BICFIIdentifier	<BIC>DEUTDEFFXXX</BIC>
End of Financial Institution Identification	</FinInstnId>
End of Member Identification	</Mmbld>
End PaymentTo	</PmtTo>
Payment From	<PmtFr>
Member Identification	<Mmbld>
Financial Institution Identification	<FinInstnId>
BICFIIdentifier	<BIC>DRESDEFFXXX</BIC>
End of Financial Institution Identification	</FinInstnId>
End of Member Identification	</Mmbld>
End Payment From	</PmtFr>
Credit Debit Indicator	<CdtDbtInd>CRDT</CdtDbtInd>
Payment	<Pmt>
InstructedAmount	<InstdAmt>
Amount without currency	<AmtWthtCcy>500000.00</AmtWthtCcy>
End Instructed Amount	</InstdAmt>
Priority	<Prty>
Priority Code	<Cd>NORM</Cd>
End Priority	</Prty>
Value date	<IntrBkSttlmDt>2007-10-12</IntrBkSttlmDt>
End of Payment	</Pmt>
End of Transaction	</Tx>
End of TransactionOrErrorChoice	</TxOrErr>
End of Transaction Report	</TxRpt>
End of BusinessReport	</BizRpt>
End of AccountOrOperationalErrorChoice	</RptOrErr>
End messageName ReturnTransaction	</RtrTx>

ReturnTransaction_PM_4

Scope: Return Transaction response for rejected payments

MessageName for Return Transaction	<RtrTx>
Message Header	<MsgHdr>
Message Identification	<MsgId>ABCDEFGHIJKLMNQRSTUWXYZabcdefghi</MsgId>
Original Business Query	<OrgnlBizQry>
Message Identification	<MsgId>ABCDEFGHIJKLMNQRST12345678</MsgId>
End of Original Business Query	</OrgnlBizQry>
End of Message Header	</MsgHdr>
AccountOrOperationalErrorChoice	<RptOrErr>
BusinessReport	<BizRpt>
TransactionReport	<TxRpt>
PaymentIdentification	<PmtId>
ProprietaryId	<PrtryId>12345</PrtryId>
EndPaymentIdentification	</PmtId>
TransactionOrErrorChoice	<TxOrErr>
Transaction	<Tx>
Credit Debit Indicator	<CdtDbtInd>CRDT</CdtDbtInd>
Payment	<Pmt>
MessageIdentification	<MsgId>345</MsgId>
PaymentStatus	<Sts>
PaymentStatusCode	<Cd>
FinalStatus	<Fnl>RJTD</Fnl>
End of PaymentStatusCode	</Cd>
Reason	<Rsn>
ProprietaryStatusJustification	<PrtryRjctn>
ProprietaryStatusReasonCode	<PrtryStsRsn>XI00</PrtryStsRsn>
Reason	<Rsn>Credit and debit account must be different</Rsn>
End of ProprietaryStatusJustification	</PrtryRjctn>
End of Reason	</Rsn>
End of PaymentStatus	</Sts>
InstructedAmount	<InstdAmt>
Amount without currency	<AmtWthtCcy>1000.00</AmtWthtCcy>
End Instructed Amount	</InstdAmt>
PaymentMethod	<PmtMtd>
FINMessageType	<FINMT>202</FINMT>
End of Payment Method	</PmtMtd>
Priority	<Prty>
Priority Code	<Cd>HIGH</Cd>
End Priority	</Prty>
Type	<Tp>
ProprietaryPaymentTypeCode	<PrtryPmtTp>REGP</PrtryPmtTp>
End of Type	</Tp>
TransactionIdentification 16x	<TxId>ABC1234</TxId>
Value date	<IntrBkSttlmDt>2007-10-12</IntrBkSttlmDt>
EndToEndIdentification	<EndToEndId>ABCFG6709</EndToEndId>
Parties	<Pties>
DebtorAgent	<DbtrAgt>
Financial Institution Identification	<FinInstnId>
BICFIIdentifier	<FrstAgt>DEUTDEFFXXX</FrstAgt>
End of Financial Institution Identification	</FinInstnId>

End of DebtorAgent											</DbtrAgt>
InstructedReimbursementAgent											<InstdRmbrsmntAgt>
Financial Institution Identification											<FinInstnId>
BICFIIdentifier											<InstdAgtCrspdt>DEUTDEFFXXX</InstdAgtCrspdt>
End of Financial Institution Identification											</FinInstnId>
End of InstructedReimbursementAgent											</InstdRmbrsmntAgt>
IntermediaryAgent											<IntrmyAgt>
Financial Institution Identification											<FinInstnId>
BICFIIdentifier											<Intrmy>DRESDEFFXXX</Intrmy>
End of Financial Institution Identification											</FinInstnId>
End of IntermediaryAgent											</IntrmyAgt>
CreditorAgent											<CdtrAgt>
Financial Institution Identification											<FinInstnId>
BICFIIdentifier											<FnIAgt>DEUTDEFFXXX</FnIAgt>
End of Financial Institution Identification											</FinInstnId>
End of CreditorAgent											</CdtrAgt>
Creditor											<Cdtr>
Financial Institution Identification											<FinInstnId>
BICFIIdentifier											<Cdtr>DEUTDEFFXXX</Cdtr>
End of Financial Institution Identification											</FinInstnId>
End of Creditor											</Cdtr>
End of Parties											</Pties>
End of Payment											</Pmt>
End of Transaction											</Tx>
End of TransactionOrErrorChoice											</TxOrErr>
End of Transaction Report											</TxRpt>
End of BusinessReport											</BizRpt>
End of AccountOrOperationalErrorChoice											</RptOrErr>
End message ReturnTransaction											</RtrTx>

ReturnTransaction_PM_5

Scope: Return Transaction for pending payments, including Instruction Copy (SWIFTContainer of a FINMessage)

MessageName for Return Transaction	<RtrTx>
Message Header	<MsgId>
Message Identification	<MsgId>ABCDEFGHIJKLMNQRSTUvwxyzABCDEFGHI</MsgId>
Original Business Query	<OrgnlBizQry>
Message Identification	<MsgId>ABCDEFGHIJKLMNQRST12345678</MsgId>
End of Original Business Query	</OrgnlBizQry>
End of Message Header	</MsgHdr>
AccountOrOperationalErrorChoice	<RptOrErr>
BusinessReport	<BizRpt>
TransactionReport	<TxRpt>
PaymentIdentification	<PmtId>
ProprietaryId	<PrtryId>12345</PrtryId>
EndPaymentIdentification	</PmtId>
TransactionOrErrorChoice	<TxOrErr>
Transaction	<Tx>
PaymentTo	<PmtTo>
Member Identification	<Mmbld>
Financial Institution Identification	<FinInstnId>
BICFIIdentifier	<BIC>MARKDEFFXX</BIC>
End of Financial Institution Identification	</FinInstnId>
End of Member Identification	</Mmbld>
Payment From	<PmtFr>
Payment From	</PmtTo>
Member Identification	<Mmbld>
Financial Institution Identification	<FinInstnId>
BICFIIdentifier	<BIC>DRESDEFFXX</BIC>
End of Financial Institution Identification	</FinInstnId>
End of Member Identification	</Mmbld>
End Payment From	</PmtFr>
Credit Debit Indicator	<CdtDbtInd>CRDT</CdtDbtInd>
Payment	<Pmt>
MessageIdentification	<TxId>123</TxId>
PaymentStatus	<Sts>
PaymentStatusCode	<Cd>
Pending	<Pdg>PSTL</Pdg<Cd>>
End of PaymentStatusCode	</InstrSts>
End of PaymentStatus	</Sts>
InstructedAmount	<InstdAmt>
Amount without currency	<AmtWthtCcy>500.00</AmtWthtCcy>
End Instructed Amount	</InstdAmt>
PaymentMethod	<PmtMtd>
FINMessageType	<FINMT>202</FINMT>
End of Payment Method	</PmtMtd>
Priority	<Prty>
Priority Code	<Cd>NORM</Cd>
End Priority	</Prty>
InstructionCopy	<InstrCpy>1000x</InstrCpy>
Value date	<IntrBkSttlmDt>2007-10-12</IntrBkSttlmDt>
End of Payment	</Pmt>

End of Transaction					</Tx>
End of Transaction Or Error Choice					</TxOrErr>
End of Transaction Report					</TxRpt>
End of Business Report					</BizRpt>
End of Account Or Operational Error Choice					</RptOrErr>
End message name Return Transaction					</RtrTx>

6. 4.29 RevokeTask (for CBs only)

SSP Proprietary Messages

RevokeTask_PM

Scope: The RevokeTask message is used to revoke a pending delta amount credit line decrease.

The RevokeTask can be sent by the application of the home central bank (CB) of the account holding direct PM participant.

The RevokeTask message will be replied by a Receipt message.

<camt.998.001.xx>

Structure:

Name Proprietary message	<PrtryMsg>
Message Header	<MsgHdr>
Message Identification	<MsgId></MsgId>
End of Message Header	</MsgHdr>
Proprietary Data	<PrtryData>
Proprietary Data type	<Tp>RevokeTask</Tp>
Proprietary Data	<Data>
SSP Proprietary Data	<SspPrtryDt>
TaskIdentificationSearchCriteria	<TskId>
Additional Reference	<RltdRef>
Reference	<Ref></Ref>
End of Additional Reference	</RltdRef>
End of TaskIdentificationSearchCriteria	</TskId>
End of SSP Proprietary Data	</SspPrtryDt>
End of Proprietary Data	</Data>
End of Proprietary Data	</PrtryData>
End proprietary message	</PrtryMsg>

Attributes:

name of attribute	format	short description	description
<PrtryMsg>		Name Proprietary message Mandatory	Validation: [1..1]
<MsgHdr>		Message Header Mandatory	Set of characteristics specific to the message Message Reference Validation: [1..1]
<MsgId>-</MsgId>	35x	Message Identification Mandatory	Message Identification Validation: [1..1]
</MsgHdr>		End of Message Header Mandatory	Validation: [1..1]
<PrtryData>		Proprietary Data Mandatory	Proprietary Data Validation: [1..1]
<Tp>-</Tp>		Proprietary Data type Mandatory	Proprietary Data type here only RevokeTask is possible Validation: [1..1]
<Data>		Proprietary Data Mandatory	Proprietary data content Validation: [1..1]
<SspPrtryDt>		SSP Proprietary Data Mandatory	SSP Proprietary Data Validation: [1..1]
<TskId>		TaskIdentificationSearchCriteria Mandatory	TaskIdentificationSearchCriteria Unique and unambiguous identification of the task Validation: [1..1]
<RltdRef>		Additional Reference Mandatory	Additional Reference Validation: [1..1]
<Ref>-</Ref>	16n	Reference Mandatory	PM Task Reference Validation: [1..1]
</RltdRef>		End of Additional Reference Mandatory	End of RelatedReference Validation: [1..1]
</TskId>		End of TaskIdentificationSearchCriteria Mandatory	end of TaskIdentificationSearchCriteria Validation:

name of attribute	format	short description	description
			[1..1]
</SspPrtryDt>		End of SSP Proprietary Data Mandatory	End of Root element for all SSP proprietary data Validation: [1..1]
</Data>		End of Proprietary Data Mandatory	Validation: [1..1]
</PrtryData>		End of Proprietary Data Mandatory	End of Proprietary Data Validation: [1..1]
</PrtryMsg>		End proprietary message Mandatory	Validation: [1..1]

Error Codes:

Order	Error code				Error Text / Validation/ Remark
	SSP	Y-copy	V-shape	XML	
1	X41			1401	Error Text: No permission. RBAC User role(s) are not sufficient. Validation: RBAC role name "APPLICBTE" is required Remark: checked by ICM / Receipt
2	862	C2	TM01	2862	Error Text: Request out of cut-off time Validation: Possibility to use this function during the current phase of business day. Remark: checked by ICM/Receipt
3	X34			1304	Error Text: No task-queue information found Validation: <RltdRef><Ref> One task with the specified TaskId must be found. TaskId must be found within task records filtered according sender BIC (matching to sender BIC of the related task) and order type "delta amount credit line". Remark: checked by ICM/Receipt
4	P78			P108	Error Text: Function is only available for status open-pending. Validation: Revocation of an ICM credit line order is only possible if the task is not yet processed and task status is "pending" Remark: checked by ICM/Receipt
5	X00			0000	Error Text: O.k. Validation: Confirmation, that a task is stored in the task queue. A related reference for the subsequent processing (e.g. confirmation) of the task is returned. Remark: Receipt (status code)

RevokeTask_PM_1

Scope: RevokeTask message sent to revoke a pending delta amount credit line decrease via TaskID.

Name Proprietary message	<PrtryMsg>
Message Header	<MsgHdr>
Message Identification	<MsgId>ABC123</MsgId>
End of Message Header	</MsgHdr>
Proprietary Data	<PrtryData>
Proprietary Data type	<Tp>RevokeTask</Tp>
Proprietary Data	<Data>
SSP Proprietary Data	<SspPrtryDt>
TaskIdentificationSearchCriteria	<TskId>
Additional Reference	<RltdRef>
Reference	<Ref>1234567890123456</Ref>
End of Additional Reference	</RltdRef>
End of TaskIdentificationSearchCriteria	</TskId>
End of SSP Proprietary Data	</SspPrtryDt>
End of Proprietary Data	</Data>
End of Proprietary Data	</PrtryData>
End proprietary message	</PrtryMsg>

6. 5 XML messages related to SD

6. 5. 1 DeleteHAMAccount (for CBs only)

SSP Proprietary Messages

DeleteHAMAccount_SD

Scope: Aim :
It is used to delete HAM account. This message can be used by Central Banks only.

Precondition :

- The user is logged in and is allowed, thanks to his pre-defined role, to use this transaction.
- The requestor must know precisely the BIC11 identifying the related participant, owner of the HAM account and the responsible CB (Country Code).
- Data used by requestor to delete HAM account may be:
 - HAM account status
 - Activation date for deletion

XML Request :
Delete HAM Account

XML Response :
Receipt

<camt.998.001.xx>

Structure:

Name Proprietary message	<PrtryMsg>
Message Header	<MsgHdr>
Message Identification	<MsgId></MsgId>
End of Message Header	</MsgHdr>
Proprietary Data	<PrtryData>
Proprietary Data type	<Tp>DeleteHAMAccount</Tp>
Proprietary Data	<Data>
SSP Proprietary Data	<SspPrtryDt>
Message Type	<DeleteHAMAccount>
HAM Account	<HamAcct>
CB Responsible	<Ctry></Ctry>
BIC	<BIC></BIC>
Record Status all Modify and Delete messages	<RecSts></RecSts>
Activation Date	<ActDt></ActDt>
End of HAM Account	</HamAcct>
End of Message Type	</DeleteHAMAccount>
End of SSP Proprietary Data	</SspPrtryDt>
End of Proprietary Data	</Data>
End of Proprietary Data	</PrtryData>
End proprietary message	</PrtryMsg>

Attributes:

name of attribute	format	short description	description
<PrtryMsg>		Name Proprietary message Mandatory	Validation:
<MsgHdr>		Message Header Mandatory	Set of characteristics specific to the message Validation: [1..1]
<MsgId>-</MsgId>	35x	Message Identification Mandatory	Message Identification Validation: [1..1]
</MsgHdr>		End of Message Header Mandatory	Validation: [1..1]
<PrtryData>		Proprietary Data Mandatory	Proprietary Data Validation: [1..1]
<Tp>-</Tp>	35x	Proprietary Data type Mandatory	Proprietary Data type defines the Type of the free format XML Validation: [1..1]
<Data>		Proprietary Data Mandatory	Proprietary data content Validation: [1..1]
<SspPrtryDt>		SSP Proprietary Data Mandatory	Root element for all SSP proprietary data Validation: [1..1]
<DeleteHAMAccount>		Message Type Mandatory	Message Type Validation: [1..1]
<HamAcct>		HAM Account Mandatory	HAM Account Validation: [1..1]
<Ctry>-</Ctry>	2!c	CB Responsible Mandatory	Country Code of the Responsible CB. Validation: [1..1]
<BIC>-</BIC>	4!a2!a2!c3!c	BIC Mandatory	A code allocated to a financial institution by a Registration Authority under an international identification scheme, as described in the latest edition of the international standard ISO 9362 "Banking - Banking telecommunication messages - Bank identifier codes". BIC 11 of the Participant, owner of the related HAM Account Validation:

name of attribute	format	short description	description
			[1..1]
<RecSts>-</RecSts>	2x	Record Status all Modify and Delete messages	<p>Status of the record. List of values :</p> <p>"AC" for Active "FU" for Future "IC" for In Change</p> <p>For more information on status management, please read the ICM UserHandBook.</p> <p>Status of the related HAM Account to be deleted Value accepted for this XML Message are : "AC" for "Active", "IC" for "In Change" or "FU" for "Future"</p> <p>Mandatory</p> <p>Validation: [1..1]</p>
<ActDt>-</ActDt>	ISODate	Activation Date	<p>Date within a particular calendar year represented by YYYY-MM-DD (ISO 8601).</p> <p>Activation Date of the deletion</p> <p>Mandatory</p> <p>Validation: [1..1]</p>
</HamAcct>		End of HAM Account	<p>End of HAM Account</p> <p>Mandatory</p> <p>Validation: [1..1]</p>
</DeleteHAMAccount>		End of Message Type	<p>End of Message Type</p> <p>Mandatory</p> <p>Validation: [1..1]</p>
</SspPrtryDt>		End of SSP Proprietary Data	<p>End of Root element for all SSP proprietary data</p> <p>Mandatory</p> <p>Validation: [1..1]</p>
</Data>		End of Proprietary Data	<p>Mandatory</p> <p>Validation: [1..1]</p>
</PrtryData>		End of Proprietary Data	<p>End of Proprietary Data</p> <p>Mandatory</p> <p>Validation: [1..1]</p>
</PrtryMsg>		End proprietary message	<p>Mandatory</p> <p>Validation:</p>

Error Codes:

Order	Error code				Error Text / Validation/ Remark
	SSP	Y-copy	V-shape	XML	
1	X41			1401	Error Text: No permission. RBAC User role(s) are not sufficient. Validation: RBAC role name "APPLICBTE" is required Remark: checked by ICM / Receipt
2	X44			1404	Error Text: If "non repudiation of emission" is mandatory, the NRE indicator flag has to be present Validation: If non-repudiaton processing is mandatory, the tag <SwInt:NRIndicator>TRUE</SwInt:NRIndicator> has to be present. Remark: Receipt /checked by ICM

DeleteHAMAccount_SD_1

Scope: Scope: Deletion of the HAM Account of the Participant

Name Proprietary message	<PrtryMsg>
Message Header	<MsgHdr>
Message Identification	<MsgId>ABC123</MsgId>
End of Message Header	</MsgHdr>
Proprietary Data	<PrtryData>
Proprietary Data type	<Tp>DeleteHAMAccount</Tp>
Proprietary Data	<Data>
SSP Proprietary Data	<SspPrtryDt>
Message Type	<DeleteHAMAccount>
HAM Account	<HamAcct>
CB Responsible	<Ctry>ES</Ctry>
BIC	<BIC>ZYAJFRT0HSD</BIC>
Record Status all Modify and Delete messages	<RecSts>AC</RecSts>
Activation Date	<ActDt>2013-03-08</ActDt>
End of HAM Account	</HamAcct>
End of Message Type	</DeleteHAMAccount>
End of SSP Proprietary Data	</SspPrtryDt>
End of Proprietary Data	</Data>
End of Proprietary Data	</PrtryData>
End proprietary message	</PrtryMsg>

6. 5. 2 DeleteRTGSAccount (for CBs only)

SSP Proprietary Messages

DeleteRTGSAccount_SD

Scope: Aim :

It is used to delete RTGS account. This message can be used by Central Banks only.

Precondition :

- The user is logged in and is allowed, thanks to his pre-defined role, to use this transaction.
- The requestor must know precisely the BIC11 identifying the related participant, owner of the RTGS account and the country code of the responsible Central Bank.
- Data used by requestor to delete RTGS account may be:

- RTGS account status
- Activation date for deletion

XML Request :
Delete RTGS Account

XML Response :
Receipt

<camt.998.001.xx>

Structure:

Name Proprietary message	<PrtryMsg>
Message Header	<MsgHdr>
Message Identification	<MsgId></MsgId>
End of Message Header	</MsgHdr>
Proprietary Data	<PrtryData>
Proprietary Data type	<Tp>DeleteRTGSAccount</Tp>
Proprietary Data	<Data>
SSP Proprietary Data	<SspPrtryDt>
Message Type	<DeleteRTGSAccount>
RTGS Account	<RTGSAcct>
CB Responsible	<Ctry></Ctry>
BIC	<BIC></BIC>
Record Status all Modify and Delete messages	<RecSts></RecSts>
Activation Date	<ActDt></ActDt>
End of RTGS Account	</RTGSAcct>
End of Message Type	</DeleteRTGSAccount>
End of SSP Proprietary Data	</SspPrtryDt>
End of Proprietary Data	</Data>
End of Proprietary Data	</PrtryData>
End proprietary message	</PrtryMsg>

Attributes:

name of attribute	format	short description	description
<PrtryMsg>		Name Proprietary message Mandatory	Validation:
<MsgHdr>		Message Header Mandatory	Set of characteristics specific to the message Validation: [1..1]
<MsgId>-</MsgId>	35x	Message Identification Mandatory	Message Identification Validation: [1..1]
</MsgHdr>		End of Message Header Mandatory	Validation: [1..1]
<PrtryData>		Proprietary Data Mandatory	Proprietary Data Validation: [1..1]
<Tp>-</Tp>	35x	Proprietary Data type Mandatory	Proprietary Data type defines the Type of the free format XML Validation: [1..1]
<Data>		Proprietary Data Mandatory	Proprietary data content Validation: [1..1]
<SspPrtryDt>		SSP Proprietary Data Mandatory	Root element for all SSP proprietary data Validation: [1..1]
<DeleteRTGSAccount>		Message Type Mandatory	Message Type Validation: [1..1]
<RTGSAcct>		RTGS Account Mandatory	RTGS Account Validation: [1..1]
<Ctry>-</Ctry>	2!c	CB Responsible Mandatory	Country Code of the Responsible CB. Validation: [1..1]
<BIC>-</BIC>	4!a2!a2!c3!c	BIC Mandatory	A code allocated to a financial institution by a Registration Authority under an international identification scheme, as described in the latest edition of the international standard ISO 9362 "Banking - Banking telecommunication messages - Bank identifier codes". BIC 11 of the Participant, owner of the related RTGS Account Validation:

name of attribute	format	short description	description
			[1..1]
<RecSts>-</RecSts>	2x	Record Status all Modify and Delete messages	Status of the record. List of values : "AC" for Active "FU" for Future "IC" for In Change For more information on status management, please read the ICM UserHandBook. Status of the related RTGS Account to be deleted Value accepted for this XML Message are : "AC" for "Active", "IC" for "In Change" or "FU" for "Future" Mandatory Validation: [1..1]
<ActDt>-</ActDt>	ISODate	Activation Date	Date within a particular calendar year represented by YYYY-MM-DD (ISO 8601). Activation Date of the deletion Mandatory Validation: [1..1]
</RTGSAcct>		End of RTGS Account	End of RTGS Account Mandatory Validation: [1..1]
</DeleteRTGSAccount>		End of Message Type	End of Message Type Mandatory Validation: [1..1]
</SspPrtryDt>		End of SSP Proprietary Data	End of Root element for all SSP proprietary data Mandatory Validation: [1..1]
</Data>		End of Proprietary Data	 Mandatory Validation: [1..1]
</PrtryData>		End of Proprietary Data	End of Proprietary Data Mandatory Validation: [1..1]
</PrtryMsg>		End proprietary message	 Mandatory Validation:

Error Codes:

Order	Error code				Error Text / Validation/ Remark
	SSP	Y-copy	V-shape	XML	
1	X41			1401	Error Text: No permission. RBAC User role(s) are not sufficient. Validation: RBAC role name "APPLICBTE" is required Remark: checked by ICM / Receipt
2	X44			1404	Error Text: If "non repudiation of emission" is mandatory, the NRE indicator flag has to be present Validation: If non-repudiaton processing is mandatory, the tag <SwInt:NRIndicator>TRUE</SwInt:NRIndicator> has to be present. Remark: Receipt /checked by ICM

DeleteRTGSAccount_SD_1

Scope: Deletion of the RTGS Account of the Participant ZYAJFRT0HSD

Name Proprietary message	<PrtryMsg>
Message Header	<MsgHdr>
Message Identification	<MsgId>ABC123</MsgId>
End of Message Header	</MsgHdr>
Proprietary Data	<PrtryData>
Proprietary Data type	<Tp>DeleteRTGSAccount</Tp>
Proprietary Data	<Data>
SSP Proprietary Data	<SspPrtryDt>
Message Type	<DeleteRTGSAccount>
RTGS Account	<RTGSAcct>
CB Responsible	<Ctry>ES</Ctry>
BIC	<BIC>ZYAJFRT0HSD</BIC>
Record Status all Modify and Delete messages	<RecSts>AC</RecSts>
Activation Date	<ActDt>2013-03-08</ActDt>
End of RTGS Account	</RTGSAcct>
End of Message Type	</DeleteRTGSAccount>
End of SSP Proprietary Data	</SspPrtryDt>
End of Proprietary Data	</Data>
End of Proprietary Data	</PrtryData>
End proprietary message	</PrtryMsg>

6. 5. 3 DeleteSFAccount (for CBs only)

SSP Proprietary Messages

DeleteSFAccount_SD

Scope: Aim :
It is used to delete SF account. This message can be used by Central Banks only.

Precondition :

- The user is logged in and is allowed, thanks to his pre-defined role, to use this transaction.
- The requestor must know precisely the BIC11 identifying the related participant, owner of the SF account, and the responsible Central Bank.
- Data used by requestor to delete SF account may be:
 - SF account status
 - Activation date for deletion

XML Request :
Delete SF Account

XML Response :
Receipt

<camt.998.001.xx>

Structure:

Name Proprietary message	<PrtryMsg>
Message Header	<MsgHdr>
Message Identification	<MsgId></MsgId>
End of Message Header	</MsgHdr>
Proprietary Data	<PrtryData>
Proprietary Data type	<Tp>DeleteSFAccount</Tp>
Proprietary Data	<Data>
SSP Proprietary Data	<SspPrtryDt>
Message Type	<DeleteSFAccount>
SF Account	<StgFcltsAcct>
CB Responsible	<Ctry></Ctry>
BIC	<BIC></BIC>
Record Status all Modify and Delete messages	<RecSts></RecSts>
Activation Date	<ActDt></ActDt>
End of SF Account	</StgFcltsAcct>
Message Type	</DeleteSFAccount>
End of SSP Proprietary Data	</SspPrtryDt>
End of Proprietary Data	</Data>
End of Proprietary Data	</PrtryData>
End proprietary message	</PrtryMsg>

Attributes:

name of attribute	format	short description	description
<PrtryMsg>		Name Proprietary message Mandatory	Validation:
<MsgHdr>		Message Header Mandatory	Set of characteristics specific to the message Validation: [1..1]
<MsgId>-</MsgId>	35x	Message Identification Mandatory	Message Identification Validation: [1..1]
</MsgHdr>		End of Message Header Mandatory	Validation: [1..1]
<PrtryData>		Proprietary Data Mandatory	Proprietary Data Validation: [1..1]
<Tp>-</Tp>	35x	Proprietary Data type Mandatory	Proprietary Data type defines the Type of the free format XML Validation: [1..1]
<Data>		Proprietary Data Mandatory	Proprietary data content Validation: [1..1]
<SspPrtryDt>		SSP Proprietary Data Mandatory	Root element for all SSP proprietary data Validation: [1..1]
<DeleteSFAccount>		Message Type Mandatory	Message Type for Static Data Validation: [1..1]
<StgFcltsAcct>		SF Account Mandatory	SF Account Validation: [1..1]
<Ctry>-</Ctry>	2!c	CB Responsible Mandatory	Country Code of the Responsible CB. Validation: [1..1]
<BIC>-</BIC>	4!a2!a2!c3!c	BIC Mandatory	A code allocated to a financial institution by a Registration Authority under an international identification scheme, as described in the latest edition of the international standard ISO 9362 "Banking - Banking telecommunication messages - Bank identifier codes". BIC 11 of the Participant, owner of the related SF Account Validation:

name of attribute	format	short description	description
			[1..1]
<RecSts>-</RecSts>	2x	Record Status all Modify and Delete messages	Status of the record. List of values : "AC" for Active "FU" for Future "IC" for In Change For more information on status management, please read the ICM UserHandBook. Status of the related SF Account to be deleted Value accepted for this XML Message are : "AC" for "Active", "IC" for "In Change" or "FU" for "Future" Mandatory Validation: [1..1]
<ActDt>-</ActDt>	ISODate	Activation Date	Date within a particular calendar year represented by YYYY-MM-DD (ISO 8601). Activation Date of the deletion Mandatory Validation: [1..1]
</StgFcltsAcct>		End of SF Account	End of SF Account Mandatory Validation: [1..1]
</DeleteSFAccount>		Message Type	Message Type for Static Data Mandatory Validation: [1..1]
</SspPrtryDt>		End of SSP Proprietary Data	End of Root element for all SSP proprietary data Mandatory Validation: [1..1]
</Data>		End of Proprietary Data	 Mandatory Validation: [1..1]
</PrtryData>		End of Proprietary Data	End of Proprietary Data Mandatory Validation: [1..1]
</PrtryMsg>		End proprietary message	 Mandatory Validation:

Error Codes:

Order	Error code				Error Text / Validation/ Remark
	SSP	Y-copy	V-shape	XML	
1	X41			1401	Error Text: No permission. RBAC User role(s) are not sufficient. Validation: RBAC role name "APPLICBTE" is required Remark: checked by ICM / Receipt
2	X44			1404	Error Text: If "non repudiation of emission" is mandatory, the NRE indicator flag has to be present Validation: If non-repudiaton processing is mandatory, the tag <SwInt:NRIndicator>TRUE</SwInt:NRIndicator> has to be present. Remark: Receipt /checked by ICM

DeleteSFAccount_SD_1

Scope: Deletion of the SF Accounts of the Participant ZYAJFRT0HZ2

Name Proprietary message	<PrtryMsg>
Message Header	<MsgHdr>
Message Identification	<MsgId>ABC123</MsgId>
End of Message Header	</MsgHdr>
Proprietary Data	<PrtryData>
Proprietary Data type	<Tp>DeleteSFAccount</Tp>
Proprietary Data	<Data>
SSP Proprietary Data	<SspPrtryDt>
Message Type	<DeleteSFAccount>
SF Account	<StgFcltsAcct>
CB Responsible	<Ctry>ES</Ctry>
BIC	<BIC>ZYAJFRT0HZ2</BIC>
Record Status all Modify and Delete messages	<RecSts>AC</RecSts>
Activation Date	<ActDt>2013-03-08</ActDt>
End of SF Account	</StgFcltsAcct>
Message Type	</DeleteSFAccount>
End of SSP Proprietary Data	</SspPrtryDt>
End of Proprietary Data	</Data>
End of Proprietary Data	</PrtryData>
End proprietary message	</PrtryMsg>

6. 5. 4 DeleteSubAccount (for CBs only)

SSP Proprietary Messages

DeleteSubAccount_SD

Scope: Aim :
It is used to delete sub-account. This message can be used by Central Banks only.

Precondition :

- The user is logged in and is allowed, thanks to his pre-defined role, to use this transaction.
- The requestor must know precisely the BIC11 identifying the related participant, owner of the sub-account and the responsible Central Bank.
- Data used by requestor to delete sub-account may be:
 - Sub-account status
 - Activation date for deletion

XML Request :
Delete Sub Account

XML Response :
Receipt

<camt.998.001.xx>

Structure:

Name Proprietary message	<PrtryMsg>
Message Header	<MsgHdr>
Message Identification	<MsgId></MsgId>
End of Message Header	</MsgHdr>
Proprietary Data	<PrtryData>
Proprietary Data type	<Tp>DeleteSubAccount</Tp>
Proprietary Data	<Data>
SSP Proprietary Data	<SspPrtryDt>
Message Type	<DeleteSubAccount>
Sub Account	<SubAcct>
CB Responsible	<Ctry></Ctry>
BIC	<BIC></BIC>
Sub Account Number	<SubAcctNb></SubAcctNb>
Record Status all Modify and Delete messages	<RecSts></RecSts>
Activation Date	<ActDt></ActDt>
End of Sub Account	</SubAcct>
End of Message Type	</DeleteSubAccount>
End of SSP Proprietary Data	</SspPrtryDt>
End of Proprietary Data	</Data>
End of Proprietary Data	</PrtryData>
End proprietary message	</PrtryMsg>

Attributes:

name of attribute	format	short description	description
<PrtryMsg>		Name Proprietary message Mandatory	Validation:
<MsgHdr>		Message Header Mandatory	Set of characteristics specific to the message Validation: [1..1]
<MsgId>-</MsgId>	35x	Message Identification Mandatory	Message Identification Validation: [1..1]
</MsgHdr>		End of Message Header Mandatory	Validation: [1..1]
<PrtryData>		Proprietary Data Mandatory	Proprietary Data Validation: [1..1]
<Tp>-</Tp>	35x	Proprietary Data type Mandatory	Proprietary Data type defines the Type of the free format XML Validation: [1..1]
<Data>		Proprietary Data Mandatory	Proprietary data content Validation: [1..1]
<SspPrtryDt>		SSP Proprietary Data Mandatory	Root element for all SSP proprietary data Validation: [1..1]
<DeleteSubAccount>		Message Type Mandatory	Message Type for Static Data Validation: [1..1]
<SubAcct>		Sub Account Mandatory	Sub Account Validation: [1..1]
<Ctry>-</Ctry>	2!c	CB Responsible Mandatory	Country Code of the Responsible CB. Validation: [1..1]
<BIC>-</BIC>	4!a2!a2!c3!c	BIC Mandatory	A code allocated to a financial institution by a Registration Authority under an international identification scheme, as described in the latest edition of the international standard ISO 9362 "Banking - Banking telecommunication messages - Bank identifier codes". BIC 11 of the Participant, owner of the related Sub Account Validation:

name of attribute	format	short description	description
			[1..1]
<SubAcctNb>-</SubAcctNb>	2!c32x	Sub Account Number	Account Code. Length 34 characters. The first two characters represent the country code of the responsible CB.
		Mandatory	Validation: [1..1]
<RecSts>-</RecSts>	2x	Record Status all Modify and Delete messages	Status of the record. List of values : "AC" for Active "FU" for Future "IC" for In Change
		Mandatory	For more information on status management, please read the ICM UserHandBook. Status of the related Sub Account to be deleted Value accepted for this XML Message are : "AC" for "Active", "IC" for "In Change" or "FU" for "Future" Validation: [1..1]
<ActDt>-</ActDt>	ISODate	Activation Date	Date within a particular calendar year represented by YYYY-MM-DD (ISO 8601). Activation Date of the deletion
		Mandatory	Validation: [1..1]
</SubAcct>		End of Sub Account	End of Sub Account
		Mandatory	Validation: [1..1]
</DeleteSubAccount>		End of Message Type	Message Type for Static Data
		Mandatory	Validation: [1..1]
</SspPrtryDt>		End of SSP Proprietary Data	End of Root element for all SSP proprietary data
		Mandatory	Validation: [1..1]
</Data>		End of Proprietary Data	
		Mandatory	Validation: [1..1]
</PrtryData>		End of Proprietary Data	End of Proprietary Data
		Mandatory	Validation: [1..1]
</PrtryMsg>		End proprietary message	
		Mandatory	Validation:

Error Codes:

Order	Error code				Error Text / Validation/ Remark
	SSP	Y-copy	V-shape	XML	
1	X41			1401	Error Text: No permission. RBAC User role(s) are not sufficient. Validation: RBAC role name "APPLICBTE" is required Remark: checked by ICM / Receipt
2	X44			1404	Error Text: If "non repudiation of emission" is mandatory, the NRE indicator flag has to be present Validation: If non-repudiaton processing is mandatory, the tag <SwInt:NRIndicator>TRUE</SwInt:NRIndicator> has to be present. Remark: Receipt /checked by ICM

DeleteSubAccount_SD_1

Scope: Deletion of the Sub Account ESZYAJFRT0HSDsub1 of the Participant ZYAJFRT0HSD

Name Proprietary message	<PrtryMsg>
Message Header	<MsgHdr>
Message Identification	<Msgld>DELSUBACC20120507</Msgld>
End of Message Header	</MsgHdr>
Proprietary Data	<PrtryData>
Proprietary Data type	<Tp>DeleteSubAccount</Tp>
Proprietary Data	<Data>
SSP Proprietary Data	<SspPrtryDt>
Message Type	<DeleteSubAccount>
Sub Account	<SubAcct>
CB Responsible	<Ctry>ES</Ctry>
BIC	<BIC>ZYAJFRT0HSD</BIC>
Sub Account Number	<SubAcctNb>ESZYAJFRT0HSDsub1</SubAcctNb>
Record Status all Modify and Delete messages	<RecSts>FU</RecSts>
Activation Date	<ActDt>2013-03-12</ActDt>
End of Sub Account	</SubAcct>
End of Message Type	</DeleteSubAccount>
End of SSP Proprietary Data	</SspPrtryDt>
End of Proprietary Data	</Data>
End of Proprietary Data	</PrtryData>
End proprietary message	</PrtryMsg>

6. 5. 5 GetAS

SSP Proprietary Messages

GetAS_SD

Scope: Aim :
It is used to get information on Ancillary System.

Precondition :
The user is logged in and is allowed, thanks to his pre-defined role, to use this transaction.

Data used by requestor to get information on Ancillary Systemt may be:
Ancillary System status
Modification date (ie activation date of modification)

AS T2S can be requested only by SSP OT and T2S transit account holder
AS T2S can be requested if flag "switch T2S-SD" is set to "on"

Postcondition success :
The information on Ancillary System is delivered to the application.

Postcondition failure :
An error message with the relevant error code is issued.

XML Request :
Get AS

XML Response :
Return AS

<camt.998.001.xx>

Structure:

Name Proprietary message	<PrtryMsg>
Message Header	<MsgHdr>
Message Identification	<MsgId></MsgId>
End of Message Header	</MsgHdr>
Proprietary Data	<PrtryData>
Proprietary Data type	<Tp>GetAS</Tp>
Proprietary Data	<Data>
SSP Proprietary Data	<SspPrtryDt>
Message Type	<GetAS>
SearchCriteria	<SchCrit>
Record Status	<ListOfSts></ListOfSts>
DateSearchChoice	<DtSch>
choice	<xorFrDtToDtFrToDt>
Date From	<FrDt></FrDt>
Date Till	<ToDt></ToDt>
FromToDate	<FrToDt>
Date From	<FrDt></FrDt>
Date Till	<ToDt></ToDt>
End FromToDate	</FrToDt>
End of choice	</xorFrDtToDtFrToDt>
End of Date Search	</DtSch>
End of SearchCriteria	</SchCrit>
End of GetAS	</GetAS>
End of SSP Proprietary Data	</SspPrtryDt>
End of Proprietary Data	</Data>
End of Proprietary Data	</PrtryData>
End proprietary message	</PrtryMsg>

Attributes:

name of attribute	format	short description	description
<PrtryMsg>		Name Proprietary message Mandatory	Validation:
<MsgHdr>		Message Header Mandatory	Set of characteristics specific to the message Validation: [1..1]
<MsgId>-</MsgId>	35x	Message Identification Mandatory	Message Identification Validation: [1..1]
</MsgHdr>		End of Message Header Mandatory	Validation: [1..1]
<PrtryData>		Proprietary Data Mandatory	Proprietary Data Validation: [1..1]
<Tp>-</Tp>	35x	Proprietary Data type Mandatory	Proprietary Data type defines the Type of the free format XML Validation: [1..1]
<Data>		Proprietary Data Mandatory	Proprietary data content Validation: [1..1]
<SspPrtryDt>		SSP Proprietary Data Mandatory	Root element for all SSP proprietary data Validation: [1..1]
<GetAS>		Message Type Mandatory	Message Type Validation: [1..1]
<SchCrit>		SearchCriteria Mandatory	Defines the criteria used to search for. Validation: [1..1]
<ListOfSts>-</ListOfSts>	2x	Record Status Mandatory	List of values : "AC" for Active + In deletion (technical) + In Delivery (technical) "FU" for Future "AR" for Archived + Archived Future + Rejected "IC" for In change "AL" for all statuses "AF" for Active + In deletion (technical) + Future + In Delivery (technical) For more information on status, please read the ICM UserHandBook. Validation: [1..1]

name of attribute	format	short description	description
<DtSch>		DateSearchChoice	A choice between search criteria based on dates and date ranges.
		Optional	Validation: [0..1]
xorFrDtToDtFrToDt		choice	choice amongst <FrDt>, <ToDt> or <FrToDt>
		Optional	Validation:
<FrDt>-</FrDt>	ISODate	Date From	Date within a particular calendar year represented by YYYY-MM-DD (ISO 8601).
		Optional	Validation: [0..1]
<ToDt>-</ToDt>	ISODate	Date Till	Date within a particular calendar year represented by YYYY-MM-DD (ISO 8601).
		Optional	Validation: [0..1]
<FrToDt>		FromDate	A particular time span specified between a start date and an end date.
		Optional	Validation: [0..1]
<FrDt>-</FrDt>	ISODate	Date From	Date within a particular calendar year represented by YYYY-MM-DD (ISO 8601).
		Optional	Validation: [0..1]
<ToDt>-</ToDt>	ISODate	Date Till	Date within a particular calendar year represented by YYYY-MM-DD (ISO 8601).
		Optional	Validation: [0..1]
</FrToDt>		End FromToDate	End of a particular time span specified between a start date and an end date.
		Optional	Validation: [0..1]
/xorFrDtToDtFrToDt		End of choice	end of choice amongst <FrDt>, <ToDt> or <FrToDt>
		Optional	Validation:
</DtSch>		End of Date Search	End of Date Search
		Optional	Validation: [0..1]
</SchCrit>		End of SearchCriteria	End of SearchCriteria
		Mandatory	Validation: [1..1]
</GetAS>		End of GetAS	End of GetAS
		Mandatory	Validation: [1..1]

name of attribute	format	short description	description
</SspPrtryDt>		End of SSP Proprietary Data Mandatory	End of SSP Proprietary Data Validation: [1..1]
</Data>		End of Proprietary Data Mandatory	Validation: [1..1]
</PrtryData>		End of Proprietary Data Mandatory	End of Proprietary Data Validation: [1..1]
</PrtryMsg>		End proprietary message Mandatory	Validation:

Error Codes:

Order	Error code				Error Text / Validation/ Remark
	SSP	Y-copy	V-shape	XML	
1	X41			1401	Error Text: No permission. RBAC User role(s) are not sufficient. Validation: RBAC role name "APPLICATE", "APPLICBTE", "APPLICSTE" or "APPLIASTE" are required Remark: checked by ICM / ReturnAS

GetAS_SD_1

Scope: Request information of every active Ancillary System depending on the CB asking for

Name Proprietary message	<PrtryMsg>
Message Header	<MsgHdr>
Message Identification	<MsgId>ABC123</MsgId>
End of Message Header	</MsgHdr>
Proprietary Data	<PrtryData>
Proprietary Data type	<Tp>GetAS</Tp>
Proprietary Data	<Data>
SSP Proprietary Data	<SspPrtryDt>
Message Type	<GetAS>
SearchCriteria	<SchCrit>
Record Status	<ListOfSts>AC</ListOfSts>
DateSearchChoice	<DtSch>
FromToDate	<FrToDt>
Date From	<FrDt>2010-08-04</FrDt>
Date Till	<ToDt>2012-01-04</ToDt>
End FromToDate	</FrToDt>
End of Date Search	</DtSch>
End of SearchCriteria	</SchCrit>
End of GetAS	</GetAS>
End of SSP Proprietary Data	</SspPrtryDt>
End of Proprietary Data	</Data>
End of Proprietary Data	</PrtryData>
End proprietary message	</PrtryMsg>

6. 5. 6 GetASSettBank

SSP Proprietary Messages

GetASSettBank_SD

Scope: Aim :
It is used to get information on Ancillary System Settlement Bank.

Precondition :

- The user is logged in and is allowed, thanks to his pre-defined role, to use this transaction.
- The requestor must know precisely the BIC11 identifying the Ancillary System.

•Data used by requestor to get information on Ancillary System Settlement Bank may be:

- Status of the link between Settlement Bank and AS
- Modification date (ie activation date of modification)

Postcondition success :

The information on the requested Ancillary System is delivered to the application.

Postcondition failure :

An error message with the relevant error code is issued.

XML Request :

Get ASSettBank

XML Response :

Return ASSettBank

<camt.998.001.xx>

Structure:

Name Proprietary message	<PrtryMsg>
Message Header	<MsgHdr>
Message Identification	<MsgId></MsgId>
End of Message Header	</MsgHdr>
Proprietary Data	<PrtryData>
Proprietary Data type	<Tp>GetASSettBank</Tp>
Proprietary Data	<Data>
SSP Proprietary Data	<SspPrtryDt>
Message Type	<GetASSettBank>
SearchCriteria	<SchCrit>
AS BIC	<ASBIC></ASBIC>
Record Status	<RecSts></RecSts>
DateSearchChoice	<DtSch>
choice	<xorFrDtToDtFrToDt>
Date From	<FrDt></FrDt>
Date Till	<ToDt></ToDt>
FromToDate	<FrToDt>
Date From	<FrDt></FrDt>
Date Till	<ToDt></ToDt>
End FromToDate	</FrToDt>
End of choice	</xorFrDtToDtFrToDt>
End of Date Search	</DtSch>
End of SearchCriteria	</SchCrit>
End of GetASSettBank	</GetASSettBank>
End of SSP Proprietary Data	</SspPrtryDt>
End of Proprietary Data	</Data>
End of Proprietary Data	</PrtryData>
End proprietary message	</PrtryMsg>

Attributes:

name of attribute	format	short description	description
<PrtryMsg>		Name Proprietary message Mandatory	Validation:
<MsgHdr>		Message Header Mandatory	Set of characteristics specific to the message Validation: [1..1]
<MsgId></MsgId>	35x	Message Identification Mandatory	Message Identification Validation: [1..1]
</MsgHdr>		End of Message Header Mandatory	Validation: [1..1]
<PrtryData>		Proprietary Data Mandatory	Proprietary Data Validation: [1..1]
<Tp></Tp>	35x	Proprietary Data type Mandatory	Proprietary Data type defines the Type of the free format XML Validation: [1..1]
<Data>		Proprietary Data Mandatory	Proprietary data content Validation: [1..1]
<SspPrtryDt>		SSP Proprietary Data Mandatory	Root element for all SSP proprietary data Validation: [1..1]
<GetASSettBank>		Message Type Mandatory	Message Type Validation: [1..1]
<SchCrit>		SearchCriteria Mandatory	Defines the criteria used to search for. Validation: [1..1]
<ASBIC></ASBIC>	11x	AS BIC Mandatory	A code allocated to a financial institution by a Registration Authority under an international identification scheme, as described in the latest edition of the international standard ISO 9362 "Banking - Banking telecommunication messages - Bank identifier codes". In this case, this is the BIC 11 of the Ancillary System. Validation: [1..1]
<RecSts></RecSts>	2x	Record Status	Status of the record. List of values : "AC" for Active

name of attribute	format	short description	description
			"FU" for Future "RE" for Rejected "AR" for Archived "AF" for Archived Future "IC" for In Change "DV" for Delivery (Technical) "ID" for In Deletion (Technical)
		Mandatory	For more information on status management, refer to the ICM UserHandBook. Validation: [1..1]
<DtSch>		DateSearchChoice	A choice between search criteria based on dates and date ranges.
		Optional	Validation: [0..1]
xorFrDtToDtFrToDt		choice	choice amongst <FrDt>, <ToDt> or <FrToDt>
		Optional	Validation:
<FrDt>-</FrDt>	ISODate	Date From	Date within a particular calendar year represented by YYYY-MM-DD (ISO 8601).
		Optional	Validation: [0..1]
<ToDt>-</ToDt>	ISODate	Date Till	Date within a particular calendar year represented by YYYY-MM-DD (ISO 8601).
		Optional	Validation: [0..1]
<FrToDt>		FromDate	A particular time span specified between a start date and an end date.
		Optional	Validation: [0..1]
<FrDt>-</FrDt>	ISODate	Date From	Date within a particular calendar year represented by YYYY-MM-DD (ISO 8601).
		Optional	Validation: [0..1]
<ToDt>-</ToDt>	ISODate	Date Till	Date within a particular calendar year represented by YYYY-MM-DD (ISO 8601).
		Optional	Validation: [0..1]
</FrToDt>		End FromToDate	End of a particular time span specified between a start date and an end date.
		Optional	Validation: [0..1]
/xorFrDtToDtFrToDt		End of choice	end of choice amongst <FrDt>, <ToDt> or <FrToDt>
		Optional	Validation:
</DtSch>		End of Date Search	End of Date Search
		Optional	Validation:

name of attribute	format	short description	description
			[0..1]
</SchCrit>		End of SearchCriteria	End of SearchCriteria
		Mandatory	Validation: [1..1]
</GetASSettBank>		End of GetASSettBank	End of GetASSettBank
		Mandatory	Validation: [1..1]
</SspPrtryDt>		End of SSP Proprietary Data	End of Root element for all SSP proprietary data
		Mandatory	Validation: [1..1]
</Data>		End of Proprietary Data	
		Mandatory	Validation: [1..1]
</PrtryData>		End of Proprietary Data	End of Proprietary Data
		Mandatory	Validation: [1..1]
</PrtryMsg>		End proprietary message	
		Mandatory	Validation:

Error Codes:

Order	Error code				Error Text / Validation/ Remark
	SSP	Y-copy	V-shape	XML	
1	X41			1401	Error Text: No permission. RBAC User role(s) are not sufficient. Validation: RBAC role name "APPLICATE", "APPLICBTE", "APPLICSTE" or "APPLIASTE" are required Remark: checked by ICM / ReturnASSettBank

GetASSettBank_SD_1

Scope: Request information of Settlement Banks of a given Ancillary System

Name Proprietary message	<PrtryMsg>
Message Header	<MsgHdr>
Message Identification	<MsgId>GETASSB20130122</MsgId>
End of Message Header	</MsgHdr>
Proprietary Data	<PrtryData>
Proprietary Data type	<Tp>GetASSettBank</Tp>
Proprietary Data	<Data>
SSP Proprietary Data	<SspPrtryDt>
Message Type	<GetASSettBank>
SearchCriteria	<SchCrit>
AS BIC	<ASBIC>ZYAJFRT0BAA</ASBIC>
Record Status	<RecSts>AC</RecSts>
DateSearchChoice	<DtSch>
FromToDate	<FrToDt>
Date From	<FrDt>2009-01-02</FrDt>
Date Till	<ToDt>2012-03-07</ToDt>
End FromToDate	</FrToDt>
End of Date Search	</DtSch>
End of SearchCriteria	</SchCrit>
End of GetASSettBank	</GetASSettBank>
End of SSP Proprietary Data	</SspPrtryDt>
End of Proprietary Data	</Data>
End of Proprietary Data	</PrtryData>
End proprietary message	</PrtryMsg>

6. 5. 7 GetCalendar

SSP Proprietary Messages

GetCalendar_SD

Scope: Aim :
It is used to get information on TARGET2 calendar.

Precondition :

- The user is logged in and is allowed, thanks to his pre-defined role, to use this transaction.
- The requestor must ask for a precise year.
- Data used by requestor to get information on TARGET2 calendar may be:
 - Year only

Postcondition success :
The information on the requested TARGET2 calendar for the requested year is delivered to the application.

Postcondition failure :
An error message with the relevant error code is issued.

XML Request :
Get calendar

XML Response :
Return calendar

<camt.998.001.xx>

Structure:

Name Proprietary message	<PrtryMsg>
Message Header	<MsgHdr>
Message Identification	<MsgId></MsgId>
End of Message Header	</MsgHdr>
Proprietary Data	<PrtryData>
Proprietary Data type	<Tp>GetCalendar</Tp>
Proprietary Data	<Data>
SSP Proprietary Data	<SspPrtryDt>
Message Type	<GetCalendar>
SearchCriteria	<SchCrit>
Year	<Yr></Yr>
End of SearchCriteria	</SchCrit>
End of Message Type	</GetCalendar>
End of SSP Proprietary Data	</SspPrtryDt>
End of Proprietary Data	</Data>
End of Proprietary Data	</PrtryData>
End proprietary message	</PrtryMsg>

Attributes:

name of attribute	format	short description	description
<PrtryMsg>		Name Proprietary message Mandatory	Validation: [1..1]
<MsgHdr>		Message Header Mandatory	Set of characteristics specific to the message Validation: [1..1]
<MsgId>-</MsgId>	35x	Message Identification Mandatory	Message Identification Validation: [1..1]
</MsgHdr>		End of Message Header Mandatory	Validation: [1..1]
<PrtryData>		Proprietary Data Mandatory	Proprietary Data Validation: [1..1]
<Tp>-</Tp>	35x	Proprietary Data type Mandatory	Proprietary Data type defines the Type of the free format XML Validation: [1..1]
<Data>		Proprietary Data Mandatory	Proprietary data content Validation: [1..1]
<SspPrtryDt>		SSP Proprietary Data Mandatory	Root element for all SSP proprietary data Validation: [1..1]
<GetCalendar>		Message Type Mandatory	Message Type for Static Data Validation: [1..1]
<SchCrit>		SearchCriteria Mandatory	Defines the criteria used to search for. Validation: [1..1]
<Yr>-</Yr>	Year	Year Optional	This is a year, with a format 4x : YYYY Validation: [0..1]
</SchCrit>		End of SearchCriteria Mandatory	End of SearchCriteria Validation: [1..1]
</GetCalendar>		End of Message Type Mandatory	End of Message Type for Static Data Validation:

name of attribute	format	short description	description
			[1..1]
</SspPrtryDt>		End of SSP Proprietary Data Mandatory	End of Root element for all SSP proprietary data Validation: [1..1]
</Data>		End of Proprietary Data Mandatory	Validation: [1..1]
</PrtryData>		End of Proprietary Data Mandatory	End of Proprietary Data Validation: [1..1]
</PrtryMsg>		End proprietary message Mandatory	Validation:

Error Codes:

Order	Error code				Error Text / Validation/ Remark
	SSP	Y-copy	V-shape	XML	
1	X41			1401	Error Text: No permission. RBAC User role(s) are not sufficient. Validation: RBAC role name "APPLICATE", "APPLICBTE" or "APPLIASTE" are required Remark: checked by ICM / ReturnCalendar

GetCalendar_SD_1

Scope: Request for the calendar of an existing year (e.g. 2013) in TARGET2

Name Proprietary message	<PrtryMsg>
Message Header	<MsgHdr>
Message Identification	<MsgId>GETCALENDAR2013</MsgId>
End of Message Header	</MsgHdr>
Proprietary Data	<PrtryData>
Proprietary Data type	<Tp>GetCalendar</Tp>
Proprietary Data	<Data>
SSP Proprietary Data	<SspPrtryDt>
Message Type	<GetCalendar>
SearchCriteria	<SchCrit>
Year	<Yr>2013</Yr>
End of SearchCriteria	</SchCrit>
End of Message Type	</GetCalendar>
End of SSP Proprietary Data	</SspPrtryDt>
End of Proprietary Data	</Data>
End of Proprietary Data	</PrtryData>
End proprietary message	</PrtryMsg>

6. 5. 8 GetCB

SSP Proprietary Messages

GetCB_SD

Scope: Aim :
It is used to get information on central bank.

Precondition :

- The user is logged in and is allowed, thanks to his pre-defined role, to use this transaction.
- Data used by requestor to get information on central bank may be:

- Central bank status
- Modification date (ie activation date of modification)

Postcondition success :

The information on the requested CB is delivered to the application.

Postcondition failure :

An error message with the relevant error code is issued.

XML Request :

Get CB

XML Response :

Return CB

<camt.998.001.xx>

Structure:

Name Proprietary message	<PrtryMsg>
Message Header	<MsgHdr>
Message Identification	<MsgId></MsgId>
End of Message Header	</MsgHdr>
Proprietary Data	<PrtryData>
Proprietary Data type	<Tp>GetCB</Tp>
Proprietary Data	<Data>
SSP Proprietary Data	<SspPrtryDt>
Message Type	<GetCB>
SearchCriteria	<SchCrit>
Record Status	<ListOfSts></ListOfSts>
DateSearchChoice	<DtSch>
choice	<xorFrDtToDtFrToDt>
Date From	<FrDt></FrDt>
Date Till	<ToDt></ToDt>
FromToDate	<FrToDt>
Date From	<FrDt></FrDt>
Date Till	<ToDt></ToDt>
End FromToDate	</FrToDt>
End of choice	</xorFrDtToDtFrToDt>
End of Date Search	</DtSch>
End of SearchCriteria	</SchCrit>
End of Message Type	</GetCB>
End of SSP Proprietary Data	</SspPrtryDt>
End of Proprietary Data	</Data>
End of Proprietary Data	</PrtryData>
End proprietary message	</PrtryMsg>

Attributes:

name of attribute	format	short description	description
<PrtryMsg>		Name Proprietary message Mandatory	Validation:
<MsgHdr>		Message Header Mandatory	Set of characteristics specific to the message Validation: [1..1]
<MsgId>-</MsgId>	35x	Message Identification Mandatory	Message Identification Validation: [1..1]
</MsgHdr>		End of Message Header Mandatory	Validation: [1..1]
<PrtryData>		Proprietary Data Mandatory	Proprietary Data Validation: [1..1]
<Tp>-</Tp>	35x	Proprietary Data type Mandatory	Proprietary Data type defines the Type of the free format XML Validation: [1..1]
<Data>		Proprietary Data Mandatory	Proprietary data content Validation: [1..1]
<SspPrtryDt>		SSP Proprietary Data Mandatory	Root element for all SSP proprietary data Validation: [1..1]
<GetCB>		Message Type Mandatory	Message Type for Static Data Validation: [1..1]
<SchCrit>		SearchCriteria Mandatory	Defines the criteria used to search for. Validation: [1..1]
<ListOfSts>-</ListOfSts>	2x	Record Status Mandatory	List of values : "AC" for Active + In deletion (technical) + In Delivery (technical) "FU" for Future "AR" for Archived + Archived Future + Rejected "IC" for In change "AL" for all statuses "AF" for Active + In deletion (technical) + Future + In Delivery (technical) For more information on status, please read the ICM UserHandBook. Validation: [1..1]

name of attribute	format	short description	description
<DtSch>		DateSearchChoice	A choice between search criteria based on dates and date ranges.
		Optional	Validation: [0..1]
xorFrDtToDtFrToDt		choice	choice amongst <FrDt>, <ToDt> or <FrToDt>
		Optional	Validation:
<FrDt>-</FrDt>	ISODate	Date From	Date within a particular calendar year represented by YYYY-MM-DD (ISO 8601).
		Optional	Validation: [0..1]
<ToDt>-</ToDt>	ISODate	Date Till	Date within a particular calendar year represented by YYYY-MM-DD (ISO 8601).
		Optional	Validation: [0..1]
<FrToDt>		FromDate	A particular time span specified between a start date and an end date.
		Optional	Validation: [0..1]
<FrDt>-</FrDt>	ISODate	Date From	Date within a particular calendar year represented by YYYY-MM-DD (ISO 8601).
		Optional	Validation: [0..1]
<ToDt>-</ToDt>	ISODate	Date Till	Date within a particular calendar year represented by YYYY-MM-DD (ISO 8601).
		Optional	Validation: [0..1]
</FrToDt>		End FromToDate	End of a particular time span specified between a start date and an end date.
		Optional	Validation: [0..1]
/xorFrDtToDtFrToDt		End of choice	end of choice amongst <FrDt>, <ToDt> or <FrToDt>
		Optional	Validation:
</DtSch>		End of Date Search	End of Date Search
		Mandatory	Validation: [1..1]
</SchCrit>		End of SearchCriteria	End of SearchCriteria
		Mandatory	Validation: [1..1]
</GetCB>		End of Message Type	End of Message Type for Static Data
		Mandatory	Validation: [1..1]

name of attribute	format	short description	description
</SspPrtryDt>		End of SSP Proprietary Data Mandatory	End of Root element for all SSP proprietary data Validation: [1..1]
</Data>		End of Proprietary Data Mandatory	Validation: [1..1]
</PrtryData>		End of Proprietary Data Mandatory	End of Proprietary Data Validation: [1..1]
</PrtryMsg>		End proprietary message Mandatory	Validation:

Error Codes:

Order	Error code				Error Text / Validation/ Remark
	SSP	Y-copy	V-shape	XML	
1	X41			1401	Error Text: No permission. RBAC User role(s) are not sufficient. Validation: RBAC role name "APPLICATE", "APPLICBTE", "APPLICSTE" or "APPLIASTE" are required Remark: checked by ICM / ReturnCB

GetCB_SD_1

Scope: Request information of every active Central Bank

Name Proprietary message	<PrtryMsg>
Message Header	<MsgHdr>
Message Identification	<MsgId>ABC123</MsgId>
End of Message Header	</MsgHdr>
Proprietary Data	<PrtryData>
Proprietary Data type	<Tp>GetCB</Tp>
Proprietary Data	<Data>
SSP Proprietary Data	<SspPrtryDt>
Message Type	<GetCB>
SearchCriteria	<SchCrit>
Record Status	<ListOfSts>AC</ListOfSts>
DateSearchChoice	<DtSch>
FromToDate	<FrToDt>
Date From	<FrDt>2013-03-15</FrDt>
Date Till	<ToDt>2013-12-31</ToDt>
End FromToDate	</FrToDt>
End of Date Search	</DtSch>
End of SearchCriteria	</SchCrit>
End of Message Type	</GetCB>
End of SSP Proprietary Data	</SspPrtryDt>
End of Proprietary Data	</Data>
End of Proprietary Data	</PrtryData>
End proprietary message	</PrtryMsg>

6. 5. 9 GetContactItem

SSP Proprietary Messages

GetContactItem_SD

Scope: Aim :
It is used to get information on contact item.

Precondition :

- The user is logged in and is allowed, thanks to his pre-defined role, to use this transaction.
- The requestor must know precisely either the BIC11 identifying:
 - a legal entity
 - a central bank
 - a participant
 - an ancillary system

Note : In case of a Participant, the Country Code of the responsible CB must also be filled in.

Postcondition success :

The information on the requested contact item is delivered to the application.

Postcondition failure :

An error message with the relevant error code is issued.

XML Request :

Get contact item

XML Response :

Return contact item

<camt.998.001.xx>

Structure:

Name Proprietary message	<PrtryMsg>
Message Header	<MsgHdr>
Message Identification	<MsgId></MsgId>
End of Message Header	</MsgHdr>
Proprietary Data	<PrtryData>
Proprietary Data type	<Tp>GetContactItem</Tp>
Proprietary Data	<Data>
SSP Proprietary Data	<SspPrtryDt>
Message Type	<GetContactItem>
SearchCriteria	<SchCrit>
Record Status	<ListOfSts></ListOfSts>
Choice amongst	<xorLglnNttyldCntrlBkldPtcptldASld>
Legal Entity Identification	<LglnNttyld>
CB Responsible	<Ctry></Ctry>
BIC Legal Entity	<BICLglnNtty></BICLglnNtty>
End of Legal Entity Identification	</LglnNttyld>
Central Bank Identification	<CntrlBkld>
CB Responsible	<Ctry></Ctry>
BIC CB	<BICCntrlBk></BICCntrlBk>
End of Central Bank Identification	</CntrlBkld>
Participant Identification	<Ptcptld>
CB Responsible	<Ctry></Ctry>
BIC Participant	<BICPtcpt></BICPtcpt>
End of Participant Identification	</Ptcptld>
AS Identification	<ASld>
CB Responsible	<Ctry></Ctry>
BIC AS	<BICAS></BICAS>
End of AS Identification	</ASld>
End of Choice	</xorLEldCBldPartldASld>

End of SearchCriteria					</SchCrit>
End of Message Type					</GetContactItem>
End of SSP Proprietary Data					</SspPrtryDt>
End of Proprietary Data					</Data>
End of Proprietary Data					</PrtryData>
End proprietary message					</PrtryMsg>

Attributes:

name of attribute	format	short description	description
<PrtryMsg>		Name Proprietary message Mandatory	Validation:
<MsgHdr>		Message Header Mandatory	Set of characteristics specific to the message Validation: [1..1]
<MsgId>-</MsgId>	35x	Message Identification Mandatory	Message Identification Validation: [1..1]
</MsgHdr>		End of Message Header Mandatory	Validation: [1..1]
<PrtryData>		Proprietary Data Mandatory	Proprietary Data Validation: [1..1]
<Tp>-</Tp>	35x	Proprietary Data type Mandatory	Proprietary Data type defines the Type of the free format XML Validation: [1..1]
<Data>		Proprietary Data Mandatory	Proprietary data content Validation: [1..1]
<SspPrtryDt>		SSP Proprietary Data Mandatory	Root element for all SSP proprietary data Validation: [1..1]
<GetContactItem>		Message Type Mandatory	Message Type for Static Data Validation: [1..1]
<SchCrit>		SearchCriteria Mandatory	Defines the criteria used to search for. Validation: [1..1]
<ListOfSts>-</ListOfSts>	2x	Record Status Mandatory	List of values : "AC" for Active + In deletion (technical) + In Delivery (technical) "FU" for Future "AR" for Archived + Archived Future + Rejected "IC" for In change "AL" for all statuses "AF" for Active + In deletion (technical) + Future + In Delivery (technical) For more information on status, please read the ICM UserHandBook. Validation: [1..1]

name of attribute	format	short description	description
xorLglNttyldCntrlBkldPtcptldASld		Choice amongst Optional	Choice amongst LEIdCBIdPartldASld (Type: xor) Validation:
<LglNttyld>		Legal Entity Identification Optional	Legal Entity Identification Validation: [0..1]
<Ctry>-</Ctry>	2!c	CB Responsible Mandatory	Country Code of the Responsible CB. Validation: [1..1]
<BICLglNtty>-</BICLglNtty>	11x	BIC Legal Entity Mandatory	A code allocated to a financial institution by a Registration Authority under an international identification scheme, as described in the latest edition of the international standard ISO 9362 "Banking - Banking telecommunication messages - Bank identifier codes". In this case, this is the BIC 11 of a Legal Entity. Validation: [1..1]
</LglNttyld>		End of Legal Entity Identification Optional	End of Legal Entity Identification Validation: [0..1]
<CntrlBkld>		Central Bank Identification Optional	Central Bank Identification Validation: [0..1]
<Ctry>-</Ctry>	2!c	CB Responsible Mandatory	Country Code of the Responsible CB. Validation: [1..1]
<BICCntrlBk>-</BICCntrlBk>	11x	BIC CB Mandatory	A code allocated to a financial institution by a Registration Authority under an international identification scheme, as described in the latest edition of the international standard ISO 9362 "Banking - Banking telecommunication messages - Bank identifier codes". In this case, this is the BIC 11 of the Central Bank. Validation: [1..1]
</CntrlBkld>		End of Central Bank Identification Optional	End of Central Bank Identification Validation: [0..1]
<Ptcptld>		Participant Identification Optional	Participant Identification Validation: [0..1]
<Ctry>-</Ctry>	2!c	CB Responsible Mandatory	Country Code of the Responsible CB. Validation: [1..1]

name of attribute	format	short description	description
<BICPtcpt>-</BICPtcpt>	11x	BIC Participant	A code allocated to a financial institution by a Registration Authority under an international identification scheme, as described in the latest edition of the international standard ISO 9362 "Banking - Banking telecommunication messages - Bank identifier codes". In this case, this is the BIC 11 of a Participant. Mandatory Validation: [1..1]
</PtcptId>		End of Participant Identification Optional	End of Participant Identification Validation: [0..1]
<ASId>		AS Identification Optional	AS Identification Validation: [0..1]
<Ctry>-</Ctry>	2!c	CB Responsible Mandatory	Country Code of the Responsible CB. Validation: [1..1]
<BICAS>-</BICAS>	11x	BIC AS Mandatory	A code allocated to a financial institution by a Registration Authority under an international identification scheme, as described in the latest edition of the international standard ISO 9362 "Banking - Banking telecommunication messages - Bank identifier codes". In this case, this is the BIC 11 of the Ancillary System. Validation: [1..1]
</ASId>		End of AS Identification Optional	End of AS Identification Validation: [0..1]
/xorLglNttyldCntrlBkldPtcpIdASId		End of Choice Optional	End of Choice Validation:
</SchCrit>		End of SearchCriteria Mandatory	End of SearchCriteria Validation: [1..1]
</GetContactItem>		End of Message Type Mandatory	End of Message Type for Static Data Validation: [1..1]
</SspPrtryDt>		End of SSP Proprietary Data Mandatory	End of Root element for all SSP proprietary data Validation: [1..1]
</Data>		End of Proprietary Data Mandatory	Validation: [1..1]

name of attribute	format	short description	description
</PrtryData>		End of Proprietary Data	End of Proprietary Data
		Mandatory	Validation: [1..1]
</PrtryMsg>		End proprietary message	
		Mandatory	Validation:

Error Codes:

Order	Error code				Error Text / Validation/ Remark
	SSP	Y-copy	V-shape	XML	
1	X41			1401	Error Text: No permission. RBAC User role(s) are not sufficient. Validation: RBAC role name "APPLICATE", "APPLICBTE", "APPLICSTE" or "APPLIASTE" are required Remark: checked by ICM / ReturnContactItem

GetContactItem_SD_1

Scope: Request information of every contact item of a given Legal Entity

Name Proprietary message	<PrtryMsg>
Message Header	<MsgHdr>
Message Identification	<MsgId>ABC123</MsgId>
End of Message Header	</MsgHdr>
Proprietary Data	<PrtryData>
Proprietary Data type	<Tp>GetContactItem</Tp>
Proprietary Data	<Data>
SSP Proprietary Data	<SspPrtryDt>
Message Type	<GetContactItem>
SearchCriteria	<SchCrit>
Record Status	<ListOfSts>AC</ListOfSts>
Legal Entity Identification	<LglNttyld>
CB Responsible	<Ctry>FR</Ctry>
BIC Legal Entity	<BICLglNtty>ZYAJFRT0FCB</BICLglNtty>
End of Legal Entity Identification	</LglNttyld>
End of SearchCriteria	</SchCrit>
End of Message Type	</GetContactItem>
End of SSP Proprietary Data	</SspPrtryDt>
End of Proprietary Data	</Data>
End of Proprietary Data	</PrtryData>
End proprietary message	</PrtryMsg>

GetContactItem_SD_2

Scope: Request information of every contact item of a given Central Bank

Name Proprietary message	<PrtryMsg>
Message Header	<MsgHdr>
Message Identification	<MsgId>ABC123</MsgId>
End of Message Header	</MsgHdr>
Proprietary Data	<PrtryData>
Proprietary Data type	<Tp>GetContactItem</Tp>
Proprietary Data	<Data>
SSP Proprietary Data	<SspPrtryDt>
Message Type	<GetContactItem>
SearchCriteria	<SchCrit>
Record Status	<ListOfSts>AC</ListOfSts>
Central Bank Identification	<CntrlBkld>
CB Responsible	<Ctry>ES</Ctry>
BIC CB	<BICCntrlBk>ZYAJFRT0HCB</BICCntrlBk>
End of Central Bank Identification	</CntrlBkld>
End of SearchCriteria	</SchCrit>
End of Message Type	</GetContactItem>
End of SSP Proprietary Data	</SspPrtryDt>
End of Proprietary Data	</Data>
End of Proprietary Data	</PrtryData>
End proprietary message	</PrtryMsg>

GetContactItem_SD_3

Scope: Request information of every contact item of a given Participant

Name Proprietary message	<PrtryMsg>
Message Header	<MsgHdr>
Message Identification	<MsgId>ABC123</MsgId>
End of Message Header	</MsgHdr>
Proprietary Data	<PrtryData>
Proprietary Data type	<Tp>GetContactItem</Tp>
Proprietary Data	<Data>
SSP Proprietary Data	<SspPrtryDt>
Message Type	<GetContactItem>
SearchCriteria	<SchCrit>
Record Status	<ListOfSts>AC</ListOfSts>
Participant Identification	<PtcptId>
CB Responsible	<Ctry>FR</Ctry>
BIC Participant	<BICPtcpt>SDMFRCRM010</BICPtcpt>
End of Participant Identification	</PtcptId>
End of SearchCriteria	</SchCrit>
End of Message Type	</GetContactItem>
End of SSP Proprietary Data	</SspPrtryDt>
End of Proprietary Data	</Data>
End of Proprietary Data	</PrtryData>
End proprietary message	</PrtryMsg>

GetContactItem_SD_4

Scope: Request information of every contact item of a given Ancillary System

Name Proprietary message	<PrtryMsg>
Message Header	<MsgHdr>
Message Identification	<MsgId>ABC123</MsgId>
End of Message Header	</MsgHdr>
Proprietary Data	<PrtryData>
Proprietary Data type	<Tp>GetContactItem</Tp>
Proprietary Data	<Data>
SSP Proprietary Data	<SspPrtryDt>
Message Type	<GetContactItem>
SearchCriteria	<SchCrit>
Record Status	<ListOfSts>FU</ListOfSts>
AS Identification	<ASId>
CB Responsible	<Ctry>BE</Ctry>
BIC AS	<BICAS>ZYAJFRT0BAA</BICAS>
End of AS Identification	</ASId>
End of SearchCriteria	</SchCrit>
End of Message Type	</GetContactItem>
End of SSP Proprietary Data	</SspPrtryDt>
End of Proprietary Data	</Data>
End of Proprietary Data	</PrtryData>
End proprietary message	</PrtryMsg>

6. 5.10 GetDirectDebit

SSP Proprietary Messages

GetDirectDebit_SD

Scope: Aim :
It is used to get information on authorised direct debit.

Precondition :

- The user is logged in and is allowed, thanks to his pre-defined role, to use this transaction.
- The requestor must know precisely the BIC11 identifying the participant (owner of Direct Debit) and the responsible Central Bank.
- Data used by requestor to get information on direct debit may be:
 - Direct debit status

Postcondition success :

The information on the direct debit of the requested Participant is delivered to the application.

Postcondition failure :

An error message with the relevant error code is issued.

XML Request :

Get direct debit

XML Response :

Return direct debit

<camt.998.001.xx>

Structure:

Name Proprietary message	<PrtryMsg>
Message Header	<MsgHdr>
Message Identification	<MsgId></MsgId>
End of Message Header	</MsgHdr>
Proprietary Data	<PrtryData>
Proprietary Data type	<Tp>GetDirectDebit</Tp>
Proprietary Data	<Data>
SSP Proprietary Data	<SspPrtryDt>
Message Type	<GetDirectDebit>
SearchCriteria	<SchCrit>
Participant Identification	<PtcptId>
CB Responsible	<Ctry></Ctry>
BIC Participant	<BICPtcpt></BICPtcpt>
End of Participant Identification	</PtcptId>
Direct Debit Identification	<DrctDbtId>
Record Status	<RecSts></RecSts>
End of Direct Debit Identification	</DrctDbtId>
End of SearchCriteria	</SchCrit>
End of Message Type	</GetDirectDebit>
End of SSP Proprietary Data	</SspPrtryDt>
End of Proprietary Data	</Data>
End of Proprietary Data	</PrtryData>
End proprietary message	</PrtryMsg>

Attributes:

name of attribute	format	short description	description
<PrtryMsg>		Name Proprietary message Mandatory	Validation:
<MsgHdr>		Message Header Mandatory	Set of characteristics specific to the message Validation: [1..1]
<MsgId>-</MsgId>	35x	Message Identification Mandatory	Message Identification Validation: [1..1]
</MsgHdr>		End of Message Header Mandatory	Validation: [1..1]
<PrtryData>		Proprietary Data Mandatory	Proprietary Data Validation: [1..1]
<Tp>-</Tp>	35x	Proprietary Data type Mandatory	Proprietary Data type defines the Type of the free format XML Validation: [1..1]
<Data>		Proprietary Data Mandatory	Proprietary data content Validation: [1..1]
<SspPrtryDt>		SSP Proprietary Data Mandatory	Root element for all SSP proprietary data Validation: [1..1]
<GetDirectDebit>		Message Type Mandatory	Message Type for Static Data Validation: [1..1]
<SchCrit>		SearchCriteria Mandatory	Defines the criteria used to search for. Validation: [1..1]
<PtcptId>		Participant Identification Mandatory	Participant Identification Validation: [1..1]
<Ctry>-</Ctry>	2!c	CB Responsible Mandatory	Country Code of the Responsible CB. Validation: [1..1]
<BICPtcpt>-</BICPtcpt>	11x	BIC Participant	A code allocated to a financial institution by a Registration Authority under an international identification scheme, as described in the latest edition of the international standard ISO 9362 "Banking -

name of attribute	format	short description	description
			Banking telecommunication messages - Bank identifier codes". In this case, this is the BIC 11 of a Participant. Mandatory Validation: [1..1]
</PtcptId>		End of Participant Identification Mandatory	End of Participant Identification Validation: [1..1]
<DrctDbtId>		Direct Debit Identification Mandatory	Direct Debit Identification Validation: [1..1]
<RecSts>-</RecSts>	2x	Record Status	Status of the record. List of values : "AC" for Active "FU" for Future "RE" for Rejected "AR" for Archived "AF" for Archived Future "IC" for In Change "DV" for Delivery (Technical) "ID" for In Deletion (Technical) For more information on status management, refer to the ICM UserHandBook. Mandatory Validation: [1..1]
</DrctDbtId>		End of Direct Debit Identification Mandatory	End of Direct Debit Identification Validation: [1..1]
</SchCrit>		End of SearchCriteria Mandatory	End of SearchCriteria Validation: [1..1]
</GetDirectDebit>		End of Message Type Mandatory	End of Message Type for Static Data Validation: [1..1]
</SspPrtryDt>		End of SSP Proprietary Data Mandatory	End of Root element for all SSP proprietary data Validation: [1..1]
</Data>		End of Proprietary Data Mandatory	Validation: [1..1]
</PrtryData>		End of Proprietary Data Mandatory	End of Proprietary Data Validation: [1..1]
</PrtryMsg>		End proprietary message Mandatory	Validation:

name of attribute	format	short description	description
-------------------	--------	-------------------	-------------

Error Codes:

Order	Error code				Error Text / Validation/ Remark
	SSP	Y-copy	V-shape	XML	
1	X41			1401	Error Text: No permission. RBAC User role(s) are not sufficient. Validation: RBAC role name "APPLICATE", "APPLICSTE" or "APPLICBTE" are required Remark: checked by ICM / ReturnDirectDebit

GetDirectDebit_SD_1

Scope: Request for information on an authorized Direct Debit of the Participant ZYAJFRT0BS1

Name Proprietary message	<PrtryMsg>
Message Header	<MsgHdr>
Message Identification	<MsgId>GETDD20130121</MsgId>
End of Message Header	</MsgHdr>
Proprietary Data	<PrtryData>
Proprietary Data type	<Tp>GetDirectDebit</Tp>
Proprietary Data	<Data>
SSP Proprietary Data	<SspPrtryDt>
Message Type	<GetDirectDebit>
SearchCriteria	<SchCrit>
Participant Identification	<PtcptId>
CB Responsible	<Ctry>BE</Ctry>
BIC Participant	<BICPtcpt>ZYAJFRT0BS1</BICPtcpt>
End of Participant Identification	</PtcptId>
Direct Debit Identification	<DrctDbtId>
Record Status	<RecSts>AC</RecSts>
End of Direct Debit Identification	</DrctDbtId>
End of SearchCriteria	</SchCrit>
End of Message Type	</GetDirectDebit>
End of SSP Proprietary Data	</SspPrtryDt>
End of Proprietary Data	</Data>
End of Proprietary Data	</PrtryData>
End proprietary message	</PrtryMsg>

6. 5.11 GetErrorCode

SSP Proprietary Messages

GetErrorCode_SD

Scope: Aim :
It is used to get list of error codes.

Precondition :
•The user is logged in and is allowed, thanks to his pre-defined role, to use this transaction.

Postcondition success :
The information on error code is delivered to the application.

Postcondition failure :
An error message with the relevant error code is issued.

XML Request :
Get error code

XML Response :
Return error code

<camt.998.001.xx>

Structure:

Name Proprietary message	<PrtryMsg>
Message Header	<MsgHdr>
Message Identification	<MsgId></MsgId>
End of Message Header	</MsgHdr>
Proprietary Data	<PrtryData>
Proprietary Data type	<Tp>GetErrorCode</Tp>
Proprietary Data	<Data>
SSP Proprietary Data	<SspPrtryDt>
Message Type	<GetErrorCode>
End of Message Type	</GetErrorCode>
End of SSP Proprietary Data	</SspPrtryDt>
End of Proprietary Data	</Data>
End of Proprietary Data	</PrtryData>
End proprietary message	</PrtryMsg>

Attributes:

name of attribute	format	short description	description
<PrtryMsg>		Name Proprietary message Mandatory	Validation: [1..1]
<MsgHdr>		Message Header Mandatory	Set of characteristics specific to the message Validation: [1..1]
<MsgId>-</MsgId>	35x	Message Identification Mandatory	Message Identification Validation: [1..1]
</MsgHdr>		End of Message Header Mandatory	Validation: [1..1]
<PrtryData>		Proprietary Data Mandatory	Proprietary Data Validation: [1..1]
<Tp>-</Tp>	35x	Proprietary Data type Mandatory	Proprietary Data type defines the Type of the free format XML Validation: [1..1]
<Data>		Proprietary Data Mandatory	Proprietary data content Validation: [1..1]
<SspPrtryDt>		SSP Proprietary Data Mandatory	Root element for all SSP proprietary data Validation: [1..1]
<GetErrorCode>		Message Type Mandatory	Message Type for Static Data Validation: [1..1]
</GetErrorCode>		End of Message Type Mandatory	End of Message Type for Static Data Validation: [1..1]
</SspPrtryDt>		End of SSP Proprietary Data Mandatory	End of Root element for all SSP proprietary data Validation: [1..1]
</Data>		End of Proprietary Data Mandatory	Validation: [1..1]
</PrtryData>		End of Proprietary Data Mandatory	End of Proprietary Data Validation: [1..1]

name of attribute	format	short description	description
</PrtryMsg>		End proprietary message Mandatory	Validation:

Error Codes:

Order	Error code				Error Text / Validation/ Remark
	SSP	Y-copy	V-shape	XML	
1	X41			1401	Error Text: No permission. RBAC User role(s) are not sufficient. Validation: RBAC role name "APPLICATE", "APPLICBTE", "APPLICSTE" or "APPLIASTE" are required Remark: checked by ICM / ReturnErrorCode

GetErrorCode_SD_1

Scope: Request information of every existing error code

Name Proprietary message	<PrtryMsg>
Message Header	<MsgHdr>
Message Identification	<MsgId>ABC123</MsgId>
End of Message Header	</MsgHdr>
Proprietary Data	<PrtryData>
Proprietary Data type	<Tp>GetErrorCode</Tp>
Proprietary Data	<Data>
SSP Proprietary Data	<SspPrtryDt>
Message Type	<GetErrorCode>
End of Message Type	</GetErrorCode>
End of SSP Proprietary Data	</SspPrtryDt>
End of Proprietary Data	</Data>
End of Proprietary Data	</PrtryData>
End proprietary message	</PrtryMsg>

6. 5.12 GetEvent

SSP Proprietary Messages

GetEvent_SD

Scope: Aim :
It is used to get information on TARGET events.

Precondition :

- The user is logged in and is allowed, thanks to his pre-defined role, to use this transaction.
- Data used by requestor to get information on TARGET events may be:
 - Event status
 - Event responsible
 - Event type
 - Modification date (ie activation date of modification)

Postcondition success :

The information on the requested TARGET event is delivered to the application.

Postcondition failure :

An error message with the relevant error code is issued.

XML Request :

Get event

XML Response :

Return event

<camt.998.001.xx>

Structure:

Name Proprietary message	<PrtryMsg>
Message Header	<MsgHdr>
Message Identification	<MsgId></MsgId>
End of Message Header	</MsgHdr>
Proprietary Data	<PrtryData>
Proprietary Data type	<Tp>GetEvent</Tp>
Proprietary Data	<Data>
SSP Proprietary Data	<SspPrtryDt>
Message Type	<GetEvent>
SearchCriteria	<SchCrit>
Event Identification	<EvtId>
Record Status	<ListOfSts></ListOfSts>
Event Type	<EvtTp></EvtTp>
Country Code for Event	<EvtCtry></EvtCtry>
Module	<Mdle></Mdle>
End of Event Identification	</EvtId>
DateSearchChoice	<DtSch>
choice	<xorFrDtToDtFrToDt>
Date From	<FrDt></FrDt>
Date Till	<ToDt></ToDt>
FromToDate	<FrToDt>
Date From	<FrDt></FrDt>
Date Till	<ToDt></ToDt>
End FromToDate	</FrToDt>
End of choice	</xorFrDtToDtFrToDt>
End of Date Search	</DtSch>
End of SearchCriteria	</SchCrit>
End of Message Type	</GetEvent>
End of SSP Proprietary Data	</SspPrtryDt>
End of Proprietary Data	</Data>
End of Proprietary Data	</PrtryData>

End proprietary message

</PrtryMsg>

Attributes:

name of attribute	format	short description	description
<PrtryMsg>		Name Proprietary message Mandatory	Validation:
<MsgHdr>		Message Header Mandatory	Set of characteristics specific to the message Validation: [1..1]
<MsgId>-</MsgId>	35x	Message Identification Mandatory	Message Identification Validation: [1..1]
</MsgHdr>		End of Message Header Mandatory	Validation: [1..1]
<PrtryData>		Proprietary Data Mandatory	Proprietary Data Validation: [1..1]
<Tp>-</Tp>	35x	Proprietary Data type Mandatory	Proprietary Data type defines the Type of the free format XML Validation: [1..1]
<Data>		Proprietary Data Mandatory	Proprietary data content Validation: [1..1]
<SspPrtryDt>		SSP Proprietary Data Mandatory	Root element for all SSP proprietary data Validation: [1..1]
<GetEvent>		Message Type Mandatory	Message Type for Static Data Validation: [1..1]
<SchCrit>		SearchCriteria Mandatory	Defines the criteria used to search for. Validation: [1..1]
<EvtId>		Event Identification Mandatory	Event Identification Validation: [1..1]
<ListOfSts>-</ListOfSts>	2x	Record Status	List of values : "AC" for Active + In deletion (technical) + In Delivery (technical) "FU" for Future "AR" for Archived + Archived Future + Rejected "IC" for In change "AL" for all statuses "AF" for Active + In deletion (technical) + Future + In Delivery (technical)

name of attribute	format	short description	description
			For more information on status, please read the ICM UserHandBook.
		Mandatory	Validation: [1..1]
<EvtTp>-</EvtTp>	4x	Event Type	Type of event. Max 4 characters, amongst a list of values.
		Optional	Validation: [0..1]
<EvtCtry>-</EvtCtry>	2x	Country Code for Event	This is the country code attached to the related event.
		Optional	Validation: [0..1]
<Mdle>-</Mdle>	4c	Module	The list of allowed values is : "SSP" meaning that common SSP events are requested "RTGS" meaning that PM events are requested "HAM" meaning that HAM events are requested "RM" meaning that RM events are requested "SF" meaning that SF events are requested "CO1" meaning that CROSS events are requested "CIB" meaning that CRISP events are requested "CII" meaning that CRISP INVOICE events are requested "CA1" meaning that CRAKS1PM events are requested "CA3" meaning that CRAKS3 events are requested "ALL" meaning that all events are to be returned
		Optional	Module of the event Validation: [0..1]
</EvtId>		End of Event Identification	End of Event Identification
		Mandatory	Validation: [1..1]
<DtSch>		DateSearchChoice	A choice between search criteria based on dates and date ranges.
		Optional	Validation: [0..1]
xorFrDtToDtFrToDt		choice	choice amongst <FrDt>, <ToDt> or <FrToDt>
		Optional	Validation:
<FrDt>-</FrDt>	ISODate	Date From	Date within a particular calendar year represented by YYYY-MM-DD (ISO 8601).
		Optional	Validation: [0..1]
<ToDt>-</ToDt>	ISODate	Date Till	Date within a particular calendar year represented by YYYY-MM-DD (ISO 8601).
		Optional	Validation: [0..1]
<FrToDt>		FromToDate	A particular time span specified between a start date and an end date.
		Optional	Validation: [0..1]
<FrDt>-</FrDt>	ISODate	Date From	Date within a particular calendar year represented by

name of attribute	format	short description	description
			YYYY-MM-DD (ISO 8601).
		Optional	Validation: [0..1]
<ToDt>-</ToDt>	ISODate	Date Till	Date within a particular calendar year represented by YYYY-MM-DD (ISO 8601).
		Optional	Validation: [0..1]
</FrToDt>		End FromToDate	End of a particular time span specified between a start date and an end date.
		Optional	Validation: [0..1]
/xorFrDtToDtFrToDt		End of choice	end of choice amongst <FrDt>, <ToDt> or <FrToDt>
		Optional	Validation:
</DtSch>		End of Date Search	End of Date Search
		Optional	Validation: [0..1]
</SchCrit>		End of SearchCriteria	End of SearchCriteria
		Mandatory	Validation: [1..1]
</GetEvent>		End of Message Type	End of Message Type for Static Data
		Mandatory	Validation: [1..1]
</SspPrtryDt>		End of SSP Proprietary Data	End of Root element for all SSP proprietary data
		Mandatory	Validation: [1..1]
</Data>		End of Proprietary Data	
		Mandatory	Validation: [1..1]
</PrtryData>		End of Proprietary Data	End of Proprietary Data
		Mandatory	Validation: [1..1]
</PrtryMsg>		End proprietary message	
		Mandatory	Validation:

Error Codes:

Order	Error code				Error Text / Validation/ Remark
	SSP	Y-copy	V-shape	XML	
1	X41			1401	Error Text: No permission. RBAC User role(s) are not sufficient. Validation: RBAC role name "APPLICATE", "APPLICBTE", "APPLICSTE" or "APPLIASTE" are required Remark: checked by ICM / ReturnEvent

GetEvent_SD_1

Scope: Request information on SSP events

Name Proprietary message	<PrtryMsg>
Message Header	<MsgHdr>
Message Identification	<MsgId>ABC123</MsgId>
End of Message Header	</MsgHdr>
Proprietary Data	<PrtryData>
Proprietary Data type	<Tp>GetEvent</Tp>
Proprietary Data	<Data>
SSP Proprietary Data	<SspPrtryDt>
Message Type	<GetEvent>
SearchCriteria	<SchCrit>
Event Identification	<EvtId>
Record Status	<ListOfSts>AC</ListOfSts>
Event Type	<EvtTp>TIME</EvtTp>
Country Code for Event	<EvtCtry>IE</EvtCtry>
Module	<Mdle>HAM</Mdle>
End of Event Identification	</EvtId>
DateSearchChoice	<DtSch>
FromToDate	<FrToDt>
Date From	<FrDt>2010-07-29</FrDt>
Date Till	<ToDt>2013-07-29</ToDt>
End FromToDate	</FrToDt>
End of Date Search	</DtSch>
End of SearchCriteria	</SchCrit>
End of Message Type	</GetEvent>
End of SSP Proprietary Data	</SspPrtryDt>
End of Proprietary Data	</Data>
End of Proprietary Data	</PrtryData>
End proprietary message	</PrtryMsg>

6. 5.13 GetGOA

SSP Proprietary Messages

GetGOA_SD

Scope: Aim :
It is used to get information on group of accounts.

Precondition :

- The user is logged in and is allowed, thanks to his pre-defined role, to use this transaction.
- Data used by requestor to get information on group of accounts may be:
 - Group of accounts status
 - Responsible CB
 - Group of accounts name
 - Group of accounts ID
 - Group of accounts type
 - Modification date (ie activation date of modification)

Postcondition success :

The information on the requested group of accounts is delivered to the application.

Postcondition failure :

An error message with the relevant error code is issued.

XML Request :
Get GOA

XML Response :
Return GOA

<camt.998.001.xx>

Structure:

Name Proprietary message	<PrtryMsg>
Message Header	<MsgHdr>
Message Identification	<MsgId></MsgId>
End of Message Header	</MsgHdr>
Proprietary Data	<PrtryData>
Proprietary Data type	<Tp>GetGOA</Tp>
Proprietary Data	<Data>
SSP Proprietary Data	<SspPrtryDt>
Message Type	<GetGOA>
SearchCriteria	<SchCrit>
Group of Account Identification	<GOAId>
Record Status	<ListOfSts></ListOfSts>
CB Responsible	<Ctry></Ctry>
Group of Account Name	<GOANm></GOANm>
Group of Accounts ID	<GOAId></GOAId>
Group of Account Type	<GOATp></GOATp>
End of GOA Identification	</GOAId>
DateSearchChoice	<DtSch>
choice	<xorFrDtToDtFrToDt>
Date From	<FrDt></FrDt>
Date Till	<ToDt></ToDt>
FromToDate	<FrToDt>
Date From	<FrDt></FrDt>
Date Till	<ToDt></ToDt>
End FromToDate	</FrToDt>
End of choice	</xorFrDtToDtFrToDt>
End of Date Search	</DtSch>
End of SearchCriteria	</SchCrit>
End of Message Type	</GetGOA>

End of SSP Proprietary Data
End of Proprietary Data
End of Proprietary Data
End proprietary message

```
| | | </SspPrtryDt>  
| | </Data>  
| </PrtryData>  
</PrtryMsg>
```

Attributes:

name of attribute	format	short description	description
<PrtryMsg>		Name Proprietary message Mandatory	Validation:
<MsgHdr>		Message Header Mandatory	Set of characteristics specific to the message Validation: [1..1]
<MsgId>-</MsgId>	35x	Message Identification Mandatory	Message Identification Validation: [1..1]
</MsgHdr>		End of Message Header Mandatory	Validation: [1..1]
<PrtryData>		Proprietary Data Mandatory	Proprietary Data Validation: [1..1]
<Tp>-</Tp>	35x	Proprietary Data type Mandatory	Proprietary Data type defines the Type of the free format XML Validation: [1..1]
<Data>		Proprietary Data Mandatory	Proprietary data content Validation: [1..1]
<SspPrtryDt>		SSP Proprietary Data Mandatory	Root element for all SSP proprietary data Validation: [1..1]
<GetGOA>		Message Type Mandatory	Message Type for Static Data Validation: [1..1]
<SchCrit>		SearchCriteria Mandatory	Defines the criteria used to search for. Validation: [1..1]
<GOAId>		Group of Account Identification Mandatory	Group of Account Identification Validation: [1..1]
<ListOfSts>-</ListOfSts>	2x	Record Status	List of values : "AC" for Active + In deletion (technical) + In Delivery (technical) "FU" for Future "AR" for Archived + Archived Future + Rejected "IC" for In change "AL" for all statuses "AF" for Active + In deletion (technical) + Future + In Delivery (technical)

name of attribute	format	short description	description
			For more information on status, please read the ICM UserHandBook.
		Mandatory	Validation: [1..1]
<Ctry>--</Ctry>	21c	CB Responsible	Country Code of the Responsible CB.
		Mandatory	Validation: [1..1]
<GOANm>--</GOANm>	35x	Group of Account Name	Group of Account Name
		Optional	Validation: [0..1]
<GOAId>--</GOAId>	12x	Group of Accounts ID	Group of Accounts ID. Lenght 12 characters.
		Optional	Validation: [0..1]
<GOATp>--</GOATp>	21a	Group of Account Type	Type of Group of Account. Values accepted are : "CI" for Consolidated Information Group of Accounts "VA" for Virtual Group of Accounts "BG" for Banking Group Monitoring (only for CB and SSP users) "AL" for getting all type of Group of Accounts (used for 'Get' XML Message).
		Optional	Validation: [0..1]
</GOAId>		End of GOA Identification	End of GOA Identification
		Mandatory	Validation: [1..1]
<DtSch>		DateSearchChoice	A choice between search criteria based on dates and date ranges.
		Optional	Validation: [0..1]
xorFrDtToDtFrToDt		choice	choice amongst <FrDt>, <ToDt> or <FrToDt>
		Optional	Validation:
<FrDt>--</FrDt>	ISODate	Date From	Date within a particular calendar year represented by YYYY-MM-DD (ISO 8601).
		Optional	Validation: [0..1]
<ToDt>--</ToDt>	ISODate	Date Till	Date within a particular calendar year represented by YYYY-MM-DD (ISO 8601).
		Optional	Validation: [0..1]
<FrToDt>		FromDate	A particular time span specified between a start date and an end date.
		Optional	Validation: [0..1]
<FrDt>--</FrDt>	ISODate	Date From	Date within a particular calendar year represented by YYYY-MM-DD (ISO 8601).

name of attribute	format	short description	description
		Optional	Validation: [0..1]
<ToDt>-</ToDt>	ISODate	Date Till	Date within a particular calendar year represented by YYYY-MM-DD (ISO 8601).
		Optional	Validation: [0..1]
</FrToDt>		End FromToDate	End of a particular time span specified between a start date and an end date.
		Optional	Validation: [0..1]
/xorFrDtToDtFrToDt		End of choice	end of choice amongst <FrDt>, <ToDt> or <FrToDt>
		Optional	Validation: [0..1]
</DtSch>		End of Date Search	End of Date Search
		Optional	Validation: [0..1]
</SchCrit>		End of SearchCriteria	End of SearchCriteria
		Mandatory	Validation: [1..1]
</GetGOA>		End of Message Type	End of Message Type for Static Data
		Mandatory	Validation: [1..1]
</SspPrtryDt>		End of SSP Proprietary Data	End of Root element for all SSP proprietary data
		Mandatory	Validation: [1..1]
</Data>		End of Proprietary Data	
		Mandatory	Validation: [1..1]
</PrtryData>		End of Proprietary Data	End of Proprietary Data
		Mandatory	Validation: [1..1]
</PrtryMsg>		End proprietary message	
		Mandatory	Validation: [1..1]

Error Codes:

Order	Error code				Error Text / Validation/ Remark
	SSP	Y-copy	V-shape	XML	
1	X41			1401	Error Text: No permission. RBAC User role(s) are not sufficient. Validation: RBAC role name "APPLICATE", "APPLICSTE" or "APPLICBTE" are required Remark: checked by ICM / ReturnGOA

GetGOA_SD_1

Scope: Request for information on FR Active Groups of Accounts of type CI

Name Proprietary message	<PrtryMsg>
Message Header	<MsgHdr>
Message Identification	<MsgId>GETGOA20130118</MsgId>
End of Message Header	</MsgHdr>
Proprietary Data	<PrtryData>
Proprietary Data type	<Tp>GetGOA</Tp>
Proprietary Data	<Data>
SSP Proprietary Data	<SspPrtryDt>
Message Type	<GetGOA>
SearchCriteria	<SchCrit>
Group of Account Identification	<GOAId>
Record Status	<ListOfSts>AC</ListOfSts>
CB Responsible	<Ctry>FR</Ctry>
Group of Account Type	<GOATp>CI</GOATp>
End of GOA Identification	</GOAId>
DateSearchChoice	<DtSch>
FromToDate	<FrToDt>
Date From	<FrDt>2012-08-28</FrDt>
Date Till	<ToDt>2013-01-21</ToDt>
End FromToDate	</FrToDt>
End of Date Search	</DtSch>
End of SearchCriteria	</SchCrit>
End of Message Type	</GetGOA>
End of SSP Proprietary Data	</SspPrtryDt>
End of Proprietary Data	</Data>
End of Proprietary Data	</PrtryData>
End proprietary message	</PrtryMsg>

GetGOA_SD_2

Scope: Request for information on a specific Group of Accounts GOAFRBK1

Name Proprietary message	<PrtryMsg>
Message Header	<MsgHdr>
Message Identification	<MsgId>GETGOA20130121</MsgId>
End of Message Header	</MsgHdr>
Proprietary Data	<PrtryData>
Proprietary Data type	<Tp>GetGOA</Tp>
Proprietary Data	<Data>
SSP Proprietary Data	<SspPrtryDt>
Message Type	<GetGOA>
SearchCriteria	<SchCrit>
Group of Account Identification	<GOAId>
Record Status	<ListOfSts>AC</ListOfSts>
CB Responsible	<Ctry>FR</Ctry>
Group of Account Name	<GOANm>GOAFRBK1</GOANm>
Group of Accounts ID	<GOAId>GOAFRBK1</GOAId>
Group of Account Type	<GOATp>CI</GOATp>
End of GOA Identification	</GOAId>
DateSearchChoice	<DtSch>
FromToDate	<FrToDt>
Date From	<FrDt>2007-05-28</FrDt>
Date Till	<ToDt>2013-01-21</ToDt>
End FromToDate	</FrToDt>
End of Date Search	</DtSch>
End of SearchCriteria	</SchCrit>
End of Message Type	</GetGOA>
End of SSP Proprietary Data	</SspPrtryDt>
End of Proprietary Data	</Data>
End of Proprietary Data	</PrtryData>
End proprietary message	</PrtryMsg>

6. 5.14 GetHAMAccount

SSP Proprietary Messages

GetHAMAccount_SD

Scope: Aim :
It is used to get information on HAM account.

Precondition :

- The user is logged in and is allowed, thanks to his pre-defined role, to use this transaction.
- The requestor must know precisely the responsible Central Bank and the BIC11 identifying either the related participant, owner of the HAM account, or the Co-Manager, a direct participant able to manage the HAM account.
- Data used by requestor to get information on HAM account may be:
–Account status

Postcondition success :

The information on the requested HAM account is delivered to the application.

Postcondition failure :

An error message with the relevant error code is issued.

XML Request :

Get HAM account

XML Response :

Return HAM account

<camt.998.001.xx>

Structure:

Name Proprietary message	<PrtryMsg>
Message Header	<MsgHdr>
Message Identification	<MsgId></MsgId>
End of Message Header	</MsgHdr>
Proprietary Data	<PrtryData>
Proprietary Data type	<Tp>GetHamAccount</Tp>
Proprietary Data	<Data>
SSP Proprietary Data	<SspPrtryDt>
Message Type	<GetHamAccount>
SearchCriteria	<SchCrit>
choice amongst	xorPtcptCmngr
Co Manager	<Cmngr>
Participant Identification	<PtcptId>
CB Responsible	<Ctry></Ctry>
BIC Co Manager	<CmngrBIC></CmngrBIC>
End of Participant Identification	</PtcptId>
Account Identification	<AcctId>
Record Status	<ListOfSts></ListOfSts>
End of Account Identification	</AcctId>
End of Co Manager	</Cmngr>
Participant	<Ptcpt>
Participant Identification	<PtcptId>
Country Code	<Ctry></Ctry>
BIC Participant	<BICPtcpt></BICPtcpt>
End of Participant Identification	</PtcptId>
Account Identification	<AcctId>
Record Status	<RecSts></RecSts>
End of Account Identification	</AcctId>
End of Participant	</Ptcpt>
End of choice	/xorPtcptCmngr
End of SearchCriteria	</SchCrit>

End of Message Type					</GetHamAccount>
End of SSP Proprietary Data					</SspPrtryDt>
End of Proprietary Data					</Data>
End of Proprietary Data					</PrtryData>
End proprietary message					</PrtryMsg>

Attributes:

name of attribute	format	short description	description
<PrtryMsg>		Name Proprietary message Mandatory	Validation: [1..1]
<MsgHdr>		Message Header Mandatory	Set of characteristics specific to the message Validation: [1..1]
<MsgId>-</MsgId>	35x	Message Identification Mandatory	Message Identification Validation: [1..1]
</MsgHdr>		End of Message Header Mandatory	Validation: [1..1]
<PrtryData>		Proprietary Data Mandatory	Proprietary Data Validation: [1..1]
<Tp>-</Tp>	35x	Proprietary Data type Mandatory	Proprietary Data type defines the Type of the free format XML Validation: [1..1]
<Data>		Proprietary Data Mandatory	Proprietary data content Validation: [1..1]
<SspPrtryDt>		SSP Proprietary Data Mandatory	Root element for all SSP proprietary data Validation: [1..1]
<GetHamAccount>		Message Type Mandatory	Message Type for Static Data Validation: [1..1]
<SchCrit>		SearchCriteria Mandatory	Defines the criteria used to search for. Validation: [1..1]
xorPtcptCmngr		choice amongst Mandatory	choice amongst participant and co-manager Validation: [1..1]
<Cmngr>		Co Manager Optional	Co Manager Validation: [0..1]
<PtcptId>		Participant Identification Mandatory	Participant Identification Validation:

name of attribute	format	short description	description
			[1..1]
<Ctry>-</Ctry>	2!c	CB Responsible Optional	Country Code of the Responsible CB. Validation: [0..1]
<CmngnBIC>-</CmngnBIC>	11x	BIC Co Manager Mandatory	A code allocated to a financial institution by a Registration Authority under an international identification scheme, as described in the latest edition of the international standard ISO 9362 "Banking - Banking telecommunication messages - Bank identifier codes". In this case, this is the BIC 11 of the Co Manager (Participant BIC). Validation: [1..1]
</PtcptId>		End of Participant Identification Mandatory	End of Participant Identification Validation: [1..1]
<AcctId>		Account Identification Mandatory	Account Identification Validation: [1..1]
<ListOfSts>-</ListOfSts>	2x	Record Status Mandatory	List of values : "AC" for Active + In deletion (technical) + In Delivery (technical) "FU" for Future "AR" for Archived + Archived Future + Rejected "IC" for In change "AL" for all statuses "AF" for Active + In deletion (technical) + Future + In Delivery (technical) For more information on status, please read the ICM UserHandBook. Validation: [1..1]
</AcctId>		End of Account Identification Mandatory	End of Account Identification Validation: [1..1]
</Cmngn>		End of Co Manager Optional	End of Co Manager Validation: [0..1]
<Ptcpt>		Participant Optional	Participant Validation: [0..1]
<PtcptId>		Participant Identification Mandatory	Participant Identification Validation: [1..1]
<Ctry>-</Ctry>	2!a	Country Code	Country Code Code to identify a country, a dependency, or another area of particular geopolitical interest, on the basis of

name of attribute	format	short description	description
			country names obtained from the United Nations (ISO 3166, Alpha-2 code).
		Optional	Validation: [0..1]
<BICPtcpt>-</BICPtcpt>	11x	BIC Participant	A code allocated to a financial institution by a Registration Authority under an international identification scheme, as described in the latest edition of the international standard ISO 9362 "Banking - Banking telecommunication messages - Bank identifier codes". In this case, this is the BIC 11 of a Participant.
		Mandatory	Validation: [1..1]
</PtcptId>		End of Participant Identification	End of Participant Identification
		Mandatory	Validation: [1..1]
<AcctId>		Account Identification	Account Identification needed on behalf of third parties. E.g. NCB are able to start several transactions on behalf their national banking community
		Mandatory	Validation: [1..1]
<RecSts>-</RecSts>	2x	Record Status	Status of the record. List of values : "AC" for Active "FU" for Future "RE" for Rejected "AR" for Archived "AF" for Archived Future "IC" for In Change "DV" for Delivery (Technical) "ID" for In Deletion (Technical)
		Mandatory	For more information on status management, refer to the ICM UserHandBook. Validation: [1..1]
</AcctId>		End of Account Identification	End Account Identification
		Mandatory	Validation: [1..1]
</Ptcpt>		End of Participant	End of Participant
		Optional	Validation: [0..1]
/xorPtcptCmng		End of choice	End of choice amongst <Ptcpt> and <Cmng>
		Mandatory	Validation: [1..1]
</SchCrit>		End of SearchCriteria	End of SearchCriteria
		Mandatory	Validation: [1..1]

name of attribute	format	short description	description
</GetHamAccount>		End of Message Type Mandatory	End of Message Type for Static Data Validation: [1..1]
</SspPrtryDt>		End of SSP Proprietary Data Mandatory	End of Root element for all SSP proprietary data Validation: [1..1]
</Data>		End of Proprietary Data Mandatory	Validation: [1..1]
</PrtryData>		End of Proprietary Data Mandatory	End of Proprietary Data Validation: [1..1]
</PrtryMsg>		End proprietary message Mandatory	Validation:

Error Codes:

Order	Error code				Error Text / Validation/ Remark
	SSP	Y-copy	V-shape	XML	
1	X41			1401	Error Text: No permission. RBAC User role(s) are not sufficient. Validation: RBAC role name "APPLICATE", "APPLICSTE" or "APPLICBTE" are required Remark: checked by ICM / ReturnHAMAccount
2	910			S100	Error Text: No data available for selected criteria Validation: Participant without HAM Account Remark: checked by SD / ReturnHAMAccount
3	X05			1005	Error Text: Data not available Validation: Participant without co-managed account Remark: checked by SD / ReturnHAMAccount

GetHAMAccount_SD_1

Scope: Request information of the HAM account of a given participant

Name Proprietary message	<PrtryMsg>
Message Header	<MsgHdr>
Message Identification	<MsgId>ABC123</MsgId>
End of Message Header	</MsgHdr>
Proprietary Data	<PrtryData>
Proprietary Data type	<Tp>GetHamAccoun</Tp>
Proprietary Data	<Data>
SSP Proprietary Data	<SspPrtryDt>
Message Type	<GetHamAccount>
SearchCriteria	<SchCrit>
Participant	<Ptcpt>
Participant Identification	<PtcptId>
Country Code	<Ctry>BE</Ctry>
BIC Participant	<BICPtcpt>ZYAJFRT0BS1</BICPtcpt>
End of Participant Identification	</PtcptId>
Account Identification	<AcctId>
Record Status	<RecSts>AC</RecSts>
End of Account Identification	</AcctId>
End of Participant	</Ptcpt>
End of SearchCriteria	</SchCrit>
End of Message Type	</GetHamAccount>
End of SSP Proprietary Data	</SspPrtryDt>
End of Proprietary Data	</Data>
End of Proprietary Data	</PrtryData>
End proprietary message	</PrtryMsg>

GetHAMAccount_SD_2

Scope: Request information of the HAM account(s) co-managed by a given participant

Name Proprietary message	<PrtryMsg>
Message Header	<MsgHdr>
Message Identification	<MsgId>ABC123</MsgId>
End of Message Header	</MsgHdr>
Proprietary Data	<PrtryData>
Proprietary Data type	<Tp>GetHamAccount</Tp>
Proprietary Data	<Data>
SSP Proprietary Data	<SspPrtryDt>
Message Type	<GetHamAccount>
SearchCriteria	<SchCrit>
Co Manager	<Cmngr>
Participant Identification	<PtcptId>
CB Responsible	<Ctry>BE</Ctry>
BIC Co Manager	<CmngrBIC>ZYAJFRT0BS1</CmngrBIC>
End of Participant Identification	</PtcptId>
Account Identification	<AcctId>
Record Status	<ListOfSts>AC</ListOfSts>
End of Account Identification	</AcctId>
End of Co Manager	</Cmngr>
End of SearchCriteria	</SchCrit>
End of Message Type	</GetHamAccount>
End of SSP Proprietary Data	</SspPrtryDt>
End of Proprietary Data	</Data>
End of Proprietary Data	</PrtryData>
End proprietary message	</PrtryMsg>

6. 5.15 GetLegalEntity

SSP Proprietary Messages

GetLegalEntity_SD

Scope: Aim :
It is used to get information on legal entity.

Precondition :

- The user is logged in and is allowed, thanks to his pre-defined role, to use this transaction.
- Data used by requestor to get information on legal entity may be:
 - Legal entity status
 - Legal entity name
 - BIC legal entity
 - CB responsible
 - Modification date

Postcondition success :
The information on the requested legal entity is delivered to the application.

Postcondition failure :
An error message with the relevant error code is issued.

XML Request :
Get legal entity

XML Response :
Return legal entity

Note: For this request the user should try to use selection criteria in order to limit the size of the returned data otherwise the request might fail!

<camt.998.001.xx>

Structure:

Name Proprietary message	<PrtryMsg>
Message Header	<MsgHdr>
Message Identification	<MsgId></MsgId>
End of Message Header	</MsgHdr>
Proprietary Data	<PrtryData>
Proprietary Data type	<Tp>GetLegalEntity</Tp>
Proprietary Data	<Data>
SSP Proprietary Data	<SspPrtryDt>
Message Type	<GetLegalEntity>
SearchCriteria	<SchCrit>
Legal Entity Identification	<LgINttyId>
Record Status	<ListOfSts></ListOfSts>
Legal Entity Name1	<LgINttyNm1></LgINttyNm1>
BIC Legal Entity	<BICLgINtty></BICLgINtty>
CB Responsible	<Ctry>FR</Ctry>
End of Legal Entity Identification	</LgINttyId>
DateSearchChoice	<DtSch>
choice	<xorFrDtToDtFrToDt>
Date From	<FrDt></FrDt>
Date Till	<ToDt></ToDt>
FromToDate	<FrToDt>
Date From	<FrDt></FrDt>
Date Till	<ToDt></ToDt>
End FromToDate	</FrToDt>
End of choice	</xorFrDtToDtFrToDt>
End of Date Search	</DtSch>
End of SearchCriteria	</SchCrit>

End of Message Type					</GetLegalEntity>
End of SSP Proprietary Data					</SspPrtryDt>
End of Proprietary Data					</Data>
End of Proprietary Data					</PrtryData>
End proprietary message					</PrtryMsg>

Attributes:

name of attribute	format	short description	description
<PrtryMsg>		Name Proprietary message Mandatory	Validation:
<MsgHdr>		Message Header Mandatory	Set of characteristics specific to the message Validation: [1..1]
<MsgId>-</MsgId>	35x	Message Identification Mandatory	Message Identification Validation: [1..1]
</MsgHdr>		End of Message Header Mandatory	Validation: [1..1]
<PrtryData>		Proprietary Data Mandatory	Proprietary Data Validation: [1..1]
<Tp>-</Tp>	35x	Proprietary Data type Mandatory	Proprietary Data type defines the Type of the free format XML Validation: [1..1]
<Data>		Proprietary Data Mandatory	Proprietary data content Validation: [1..1]
<SspPrtryDt>		SSP Proprietary Data Mandatory	Root element for all SSP proprietary data Validation: [1..1]
<GetLegalEntity>		Message Type Mandatory	Message Type for Static Data Validation: [1..1]
<SchCrit>		SearchCriteria Optional	Defines the criteria used to search for. Validation: [0..1]
<LglNttyId>		Legal Entity Identification Mandatory	Legal Entity Identification Validation: [1..1]
<ListOfSts>-</ListOfSts>	2x	Record Status	List of values : "AC" for Active + In deletion (technical) + In Delivery (technical) "FU" for Future "AR" for Archived + Archived Future + Rejected "IC" for In change "AL" for all statuses "AF" for Active + In deletion (technical) + Future + In Delivery (technical)

name of attribute	format	short description	description
			For more information on status, please read the ICM UserHandBook.
		Mandatory	Validation: [1..1]
<LglNttyNm1>-</LglNttyNm1>	35x	Legal Entity Name1	Legal Entity Name first line.
		Optional	Validation: [0..1]
<BICLglNtty>-</BICLglNtty>	11x	BIC Legal Entity	A code allocated to a financial institution by a Registration Authority under an international identification scheme, as described in the latest edition of the international standard ISO 9362 "Banking - Banking telecommunication messages - Bank identifier codes".
		Optional	In this case, this is the BIC 11 of a Legal Entity. Validation: [0..1]
<Ctry>-</Ctry>	2!c	CB Responsible	Country Code of the Responsible CB.
		Optional	Validation: [0..1]
</LglNttyld>		End of Legal Entity Identification	End of Legal Entity Identification
		Mandatory	Validation: [1..1]
<DtSch>		DateSearchChoice	A choice between search criteria based on dates and date ranges.
		Optional	Validation: [0..1]
xorFrDtToDtFrToDt		choice	choice amongst <FrDt>, <ToDt> or <FrToDt>
		Optional	Validation:
<FrDt>-</FrDt>	ISODate	Date From	Date within a particular calendar year represented by YYYY-MM-DD (ISO 8601).
		Optional	Validation: [0..1]
<ToDt>-</ToDt>	ISODate	Date Till	Date within a particular calendar year represented by YYYY-MM-DD (ISO 8601).
		Optional	Validation: [0..1]
<FrToDt>		FromDate	A particular time span specified between a start date and an end date.
		Optional	Validation: [0..1]
<FrDt>-</FrDt>	ISODate	Date From	Date within a particular calendar year represented by YYYY-MM-DD (ISO 8601).
		Optional	Validation: [0..1]

name of attribute	format	short description	description
<ToDt>-</ToDt>	ISODate	Date Till	Date within a particular calendar year represented by YYYY-MM-DD (ISO 8601).
		Optional	Validation: [0..1]
</FrToDt>		End FromToDate	End of a particular time span specified between a start date and an end date.
		Optional	Validation: [0..1]
/xorFrDtToDtFrToDt		End of choice	end of choice amongst <FrDt>, <ToDt> or <FrToDt>
		Optional	Validation:
</DtSch>		End of Date Search	End of Date Search
		Optional	Validation: [0..1]
</SchCrit>		End of SearchCriteria	End of SearchCriteria
		Optional	Validation: [0..1]
</GetLegalEntity>		End of Message Type	End of Message Type for Static Data
		Mandatory	Validation: [1..1]
</SspPrtryDt>		End of SSP Proprietary Data	End of Root element for all SSP proprietary data
		Mandatory	Validation: [1..1]
</Data>		End of Proprietary Data	
		Mandatory	Validation: [1..1]
</PrtryData>		End of Proprietary Data	End of Proprietary Data
		Mandatory	Validation: [1..1]
</PrtryMsg>		End proprietary message	
		Mandatory	Validation:

Error Codes:

Order	Error code				Error Text / Validation/ Remark
	SSP	Y-copy	V-shape	XML	
1	X41			1401	Error Text: No permission. RBAC User role(s) are not sufficient. Validation: RBAC role name "APPLICATE", "APPLICBTE", "APPLICSTE" or "APPLIASTE" are required Remark: checked by ICM / ReturnLegalEntity

GetLegalEntity_SD_1

Scope: Request information of a Legal Entity

Name Proprietary message	<PrtryMsg>
Message Header	<MsgHdr>
Message Identification	<MsgId>ABC123</MsgId>
End of Message Header	</MsgHdr>
Proprietary Data	<PrtryData>
Proprietary Data type	<Tp>GetLegalEntity </Tp>
Proprietary Data	<Data>
SSP Proprietary Data	<SspPrtryDt>
Message Type	<GetLegalEntity>
SearchCriteria	<SchCrit>
Legal Entity Identification	<LglNttyId>
Record Status	<ListOfSts>AC</ListOfSts>
Legal Entity Name1	<LglNttyNm1>ECB</LglNttyNm1>
BIC Legal Entity	<BICLglNtty>ZYBYDEF0ECB</BICLglNtty>
CB Responsible	<Ctry>EU</Ctry>
End of Legal Entity Identification	</LglNttyId>
DateSearchChoice	<DtSch>
FromToDate	<FrToDt>
Date From	<FrDt>2010-01-02</FrDt>
Date Till	<ToDt>2013-03-07</ToDt>
End FromToDate	</FrToDt>
End of Date Search	</DtSch>
End of SearchCriteria	</SchCrit>
End of Message Type	</GetLegalEntity>
End of SSP Proprietary Data	</SspPrtryDt>
End of Proprietary Data	</Data>
End of Proprietary Data	</PrtryData>
End proprietary message	</PrtryMsg>

6. 5.16 GetParticipant

SSP Proprietary Messages

GetParticipant_SD

Scope: Aim :
It is used to get information on participant.

Precondition :

- The user is logged in and is allowed, thanks to his pre-defined role, to use this transaction.

- Data used by requestor to get information on participant may be:

- Participant status
- Participant type (CI, CB, CB Customer, ...)
- RTGS Participation Type (Direct, Indirect, No participation)
- HAM Participation (has or not a HAM Account)
- CB responsible
- Legal entity name
- BIC participant
- Participant name
- National sorting code
- Minimum reserve management
- Source of Compulsory Reserve (if possible)
- SF Allow (flag Y/N)
- Modification date (ie activation date of modification)

Postcondition success :

The information on the requested participant is delivered to the application.

Postcondition failure :

An error message with the relevant error code is issued.

XML Request :

Get participant

XML Response :

Return participant

Note: For this request the user should try to use selection criteria in order to limit the size of the returned data otherwise the request might fail!

<camt.998.001.xx>

Structure:

Name Proprietary message	<PrtryMsg>
Message Header	<MsgHdr>
Message Identification	<MsgId></MsgId>
End of Message Header	</MsgHdr>
Proprietary Data	<PrtryData>
Proprietary Data type	<Tp>GetParticipant</Tp>
Proprietary Data	<Data>
SSP Proprietary Data	<SspPrtryDt>
Message Type	<GetParticipant>
SearchCriteria	<SchCrit>
Participant Identification	<PtcptId>
Record Status	<ListOfSts></ListOfSts>
Participant Type	<PtcptTp></PtcptTp>
RTGS Participation	<RTGSTp></RTGSTp>
HAM Account	<HamAcct></HamAcct>
CB Responsible	<Ctry></Ctry>
Legal Entity Name1	<LgINttyNm1></LgINttyNm1>
BIC Participant	<BICPtcpt></BICPtcpt>
Participant Name1	<PtcptNm1></PtcptNm1>
National Sorting Code	<NSC></NSC>
Minimum Reserve Management	<CRMgmt></CRMgmt>
Source of Compulsory Reserve	<CRSrc></CRSrc>

SF Allow	<StgFclts></StgFclts>
T2S VA Allow	<T2SVASvc></T2SVASvc>
End of Participant Identification	</PtcptId>
DateSearchChoice	<DtSch>
choice	<xorFrDtToDtFrToDt>
Date From	<FrDt></FrDt>
Date Till	<ToDt></ToDt>
FromToDate	<FrToDt>
Date From	<FrDt></FrDt>
Date Till	<ToDt></ToDt>
End FromToDate	</FrToDt>
End of choice	</xorFrDtToDtFrToDt>
End of Date Search	</DtSch>
End of SearchCriteria	</SchCrit>
End of Message Type	</GetParticipant>
End of SSP Proprietary Data	</SspPrtryDt>
End of Proprietary Data	</Data>
End of Proprietary Data	</PrtryData>
End proprietary message	</PrtryMsg>

Attributes:

name of attribute	format	short description	description
<PrtryMsg>		Name Proprietary message Mandatory	Validation:
<MsgHdr>		Message Header Mandatory	Set of characteristics specific to the message Validation: [1..1]
<MsgId>-</MsgId>	35x	Message Identification Mandatory	Message Identification Validation: [1..1]
</MsgHdr>		End of Message Header Mandatory	Validation: [1..1]
<PrtryData>		Proprietary Data Mandatory	Proprietary Data Validation: [1..1]
<Tp>-</Tp>	35x	Proprietary Data type Mandatory	Proprietary Data type defines the Type of the free format XML Validation: [1..1]
<Data>		Proprietary Data Mandatory	Proprietary data content Validation: [1..1]
<SspPrtryDt>		SSP Proprietary Data Mandatory	Root element for all SSP proprietary data Validation: [1..1]
<GetParticipant>		Message Type Mandatory	Message Type for Static Data Validation: [1..1]
<SchCrit>		SearchCriteria Mandatory	Defines the criteria used to search for. Validation: [1..1]
<PtcptId>		Participant Identification Mandatory	Participant Identification Validation: [1..1]
<ListOfSts>-</ListOfSts>	2x	Record Status	List of values : "AC" for Active + In deletion (technical) + In Delivery (technical) "FU" for Future "AR" for Archived + Archived Future + Rejected "IC" for In change "AL" for all statuses "AF" for Active + In deletion (technical) + Future + In Delivery (technical)

name of attribute	format	short description	description
			For more information on status, please read the ICM UserHandBook.
		Mandatory	Validation: [1..1]
<PtcptTp>-</PtcptTp>	2!c	Participant Type	Type of participation. Values may be : CB" for Central Bank "CI" for Credit Institution "CU" for CB's Customer "TC" for Technical "AL" for getting all type of Participant (used for 'Get' XML Message).
		Optional	Validation: [0..1]
<RTGSTp>-</RTGSTp>	1!a	RTGS Participation	Defines the type of participation in the RTGS. List of values : "D" for Direct Participant "I" for Indirect Participant "N" for No Participation "A" for getting all type of RTGS Participation (used for 'Get' XML Message).
		Optional	Validation: [0..1]
<HamAcct>-</HamAcct>	1!a	HAM Account	A flag with two value : 'Y' or 'N'. This flag is used to indicate whether a participant has (value 'Y') or not (value 'N') a HAM Account.
		Optional	Validation: [0..1]
<Ctry>-</Ctry>	2!c	CB Responsible	Country Code of the Responsible CB.
		Optional	Validation: [0..1]
<LglNttyNm1>-</LglNttyNm1>	35x	Legal Entity Name1	Legal Entity Name first line.
		Optional	Validation: [0..1]
<BICPcpt>-</BICPcpt>	11x	BIC Participant	A code allocated to a financial institution by a Registration Authority under an international identification scheme, as described in the latest edition of the international standard ISO 9362 "Banking - Banking telecommunication messages - Bank identifier codes". In this case, this is the BIC 11 of a Participant.
		Optional	Validation: [0..1]
<PtcptNm1>-</PtcptNm1>	35x	Participant Name1	Participant Name, first line.
		Optional	Validation: [0..1]
<NSC>-</NSC>	15n	National Sorting Code	Code present in the BIC DATA +. Character string with a max length of 15 characters.
		Optional	Validation: [0..1]

name of attribute	format	short description	description
<CRMgmt>-</CRMgmt>	1!a	Minimum Reserve Management	This information represents the way a participant is managing minimum reserve. Values are : "D" for Direct (the participant is managing minimum reserve by itself) "I" for Indirect (the participant is managing minimum reserve through another participant) "P" for Pool (the participant is part of a MFI in order to manage minimum reserve) "L" for Locally "N" for No if the participant is not managing minimum reserve "A" for getting all values (used in the 'Get' XML Message).
		Optional	Validation: [0..1]
<CRSrc>-</CRSrc>	1!a	Source of Compulsory Reserve	Gives the source of compulsory reserve. Values are : "R" for RTGS Account "H" for HAM Account "P" for PHA (Proprietary Home Account) "A" for getting all values (used in the 'Get' XML Message).
		Optional	Validation: [0..1]
<StgFclts>-</StgFclts>	1!a	SF Allow	A flag with two values : 'Y' or 'N'. Indicates the possibility to use Standing facilities.
		Optional	Validation: [0..1]
<T2SVASvc>-</T2SVASvc>	1!a	T2S VA Allow	A flag with two values : 'Y' or 'N' indicates the participant has opted for T2S value-added service package
		Optional	Validation: [0..1]
</PtcptId>		End of Participant Identification Mandatory	End of Participant Identification Validation: [1..1]
<DtSch>		DateSearchChoice	A choice between search criteria based on dates and date ranges.
		Optional	Validation: [0..1]
xorFrDtToDtFrToDt		choice	choice amongst <FrDt>, <ToDt> or <FrToDt>
		Optional	Validation:
<FrDt>-</FrDt>	ISODate	Date From	Date within a particular calendar year represented by YYYY-MM-DD (ISO 8601).
		Optional	Validation: [0..1]
<ToDt>-</ToDt>	ISODate	Date Till	Date within a particular calendar year represented by YYYY-MM-DD (ISO 8601).
		Optional	Validation: [0..1]
<FrToDt>		FromDate	A particular time span specified between a start date and an end date.

name of attribute	format	short description	description
		Optional	Validation: [0..1]
<FrDt>-</FrDt>	ISODate	Date From	Date within a particular calendar year represented by YYYY-MM-DD (ISO 8601).
		Optional	Validation: [0..1]
<ToDt>-</ToDt>	ISODate	Date Till	Date within a particular calendar year represented by YYYY-MM-DD (ISO 8601).
		Optional	Validation: [0..1]
</FrToDt>		End FromToDate	End of a particular time span specified between a start date and an end date.
		Optional	Validation: [0..1]
/xorFrDtToDtFrToDt		End of choice	end of choice amongst <FrDt>, <ToDt> or <FrToDt>
		Optional	Validation:
</DtSch>		End of Date Search	End of Date Search
		Optional	Validation: [0..1]
</SchCrit>		End of SearchCriteria	End of SearchCriteria
		Mandatory	Validation: [1..1]
</GetParticipant>		End of Message Type	End of Message Type for Static Data
		Mandatory	Validation: [1..1]
</SspPrtryDt>		End of SSP Proprietary Data	End of Root element for all SSP proprietary data
		Mandatory	Validation: [1..1]
</Data>		End of Proprietary Data	
		Mandatory	Validation: [1..1]
</PrtryData>		End of Proprietary Data	End of Proprietary Data
		Mandatory	Validation: [1..1]
</PrtryMsg>		End proprietary message	
		Mandatory	Validation:

Error Codes:

Order	Error code				Error Text / Validation/ Remark
	SSP	Y-copy	V-shape	XML	
1	X41			1401	Error Text: No permission. RBAC User role(s) are not sufficient. Validation: RBAC role name "APPLICATE", "APPLICBTE", "APPLICSTE" or "APPLIASTE" are required Remark: checked by ICM / ReturnParticipant

GetParticipant_SD_1

Scope: General request for information on the Participant ZYBLDEF0LD4

Name Proprietary message	<PrtryMsg>
Message Header	<MsgHdr>
Message Identification	<MsgId>GetPartZYBLDEF0LD4</MsgId>
End of Message Header	</MsgHdr>
Proprietary Data	<PrtryData>
Proprietary Data type	<Tp>GetParticipant</Tp>
Proprietary Data	<Data>
SSP Proprietary Data	<SspPrtryDt>
Message Type	<GetParticipant>
SearchCriteria	<SchCrit>
Participant Identification	<PtcptId>
Record Status	<ListOfSts>AC</ListOfSts>
CB Responsible	<Ctry>LU</Ctry>
BIC Participant	<BICPtcpt>ZYBLDEF0LD4</BICPtcpt>
End of Participant Identification	</PtcptId>
End of SearchCriteria	</SchCrit>
End of Message Type	</GetParticipant>
End of SSP Proprietary Data	</SspPrtryDt>
End of Proprietary Data	</Data>
End of Proprietary Data	</PrtryData>
End proprietary message	</PrtryMsg>

GetParticipant_SD_2

Scope: Request for information on the Participant ZYAJFRT0HS1

Name Proprietary message	<PrtryMsg>
Message Header	<MsgHdr>
Message Identification	<MsgId>GetPartZYAJFRT0HS1</MsgId>
End of Message Header	</MsgHdr>
Proprietary Data	<PrtryData>
Proprietary Data type	<Tp>GetParticipant</Tp>
Proprietary Data	<Data>
SSP Proprietary Data	<SspPrtryDt>
Message Type	<GetParticipant>
SearchCriteria	<SchCrit>
Participant Identification	<PtcptId>
Record Status	<ListOfSts>AC</ListOfSts>
Participant Type	<PtcptTp>CI</PtcptTp>
RTGS Participation	<RTGSTp>D</RTGSTp>
Legal Entity Name1	<LglNttyNm1>SPAIN ASI SETTLEMENT BANKS</LglNttyNm1>
Participant Name1	<PtcptNm1>ASI Settlement Bank</PtcptNm1>
National Sorting Code	<NSC>123456789</NSC>
Minimum Reserve Management	<CRMgmt>D</CRMgmt>
Source of Compulsory Reserve	<CRSrc>R</CRSrc>
SF Allow	<StgFclts>Y</StgFclts>
T2S VA Allow	<T2SVASvc>Y</T2SVASvc>
End of Participant Identification	</PtcptId>
DateSearchChoice	<DtSch>
FromToDate	<FrToDt>
Date From	<FrDt>2008-05-03</FrDt>
Date Till	<ToDt>2012-12-31</ToDt>
End FromToDate	</FrToDt>
End of Date Search	</DtSch>
End of SearchCriteria	</SchCrit>
End of Message Type	</GetParticipant>
End of SSP Proprietary Data	</SspPrtryDt>
End of Proprietary Data	</Data>
End of Proprietary Data	</PrtryData>
End proprietary message	</PrtryMsg>

6. 5.17 GetRTGSAccount

SSP Proprietary Messages

GetRTGSAccount_SD

Scope: Aim :
It is used to get information on RTGS account.

Precondition :

- The user is logged in and is allowed, thanks to his pre-defined role, to use this transaction.
- The requestor must know precisely the BIC11 identifying the related participant, owner of the RTGS account and the Responsible Central Bank.
- Data used by requestor to get information on RTGS account may be:
 - Account status

Postcondition success :

The information on the requested RTGS account is delivered to the application.

Postcondition failure :

An error message with the relevant error code is issued.

XML Request :

Get RTGS account

XML Response :

Return RTGS account

<camt.998.001.xx>

Structure:

Name Proprietary message	<PrtryMsg>
Message Header	<MsgHdr>
Message Identification	<MsgId></MsgId>
End of Message Header	</MsgHdr>
Proprietary Data	<PrtryData>
Proprietary Data type	<Tp>GetRTGSAccount</Tp>
Proprietary Data	<Data>
SSP Proprietary Data	<SspPrtryDt>
Message Type	<GetRTGSAccount>
SearchCriteria	<SchCrit>
Participant Identification	<PtcptId>
CB Responsible	<Ctry></Ctry>
BIC Participant	<BICPtcpt></BICPtcpt>
End of Participant Identification	</PtcptId>
Account Identification	<AcctId>
Record Status	<RecSts></RecSts>
End of Account Identification	</AcctId>
End of SearchCriteria	</SchCrit>
End of Message Type	</GetRTGSAccount>
End of SSP Proprietary Data	</SspPrtryDt>
End of Proprietary Data	</Data>
End of Proprietary Data	</PrtryData>
End proprietary message	</PrtryMsg>

Attributes:

name of attribute	format	short description	description
<PrtryMsg>		Name Proprietary message Mandatory	Validation:
<MsgHdr>		Message Header Mandatory	Set of characteristics specific to the message Validation: [1..1]
<MsgId>-</MsgId>	35x	Message Identification Mandatory	Message Identification Validation: [1..1]
</MsgHdr>		End of Message Header Mandatory	Validation: [1..1]
<PrtryData>		Proprietary Data Mandatory	Proprietary Data Validation: [1..1]
<Tp>-</Tp>	35x	Proprietary Data type Mandatory	Proprietary Data type defines the Type of the free format XML Validation: [1..1]
<Data>		Proprietary Data Mandatory	Proprietary data content Validation: [1..1]
<SspPrtryDt>		SSP Proprietary Data Mandatory	Root element for all SSP proprietary data Validation: [1..1]
<GetRTGSAccount>		Message Type Mandatory	Message Type for Static Data Validation: [1..1]
<SchCrit>		SearchCriteria Mandatory	Defines the criteria used to search for. Validation: [1..1]
<PtcptId>		Participant Identification Mandatory	Participant Identification Validation: [1..1]
<Ctry>-</Ctry>	2!c	CB Responsible Mandatory	Country Code of the Responsible CB. Validation: [1..1]
<BICPtct>-</BICPtct>	11x	BIC Participant	A code allocated to a financial institution by a Registration Authority under an international identification scheme, as described in the latest edition of the international standard ISO 9362 "Banking -

name of attribute	format	short description	description
			Banking telecommunication messages - Bank identifier codes". In this case, this is the BIC 11 of a Participant. Mandatory Validation: [1..1]
</PtcptId>		End of Participant Identification Mandatory	End of Participant Identification Validation: [1..1]
<AcctId>		Account Identification Mandatory	Account Identification Validation: [1..1]
<RecSts>-</RecSts>	2x	Record Status	Status of the record. List of values : "AC" for Active "FU" for Future "RE" for Rejected "AR" for Archived "AF" for Archived Future "IC" for In Change "DV" for Delivery (Technical) "ID" for In Deletion (Technical) For more information on status management, refer to the ICM UserHandBook. Mandatory Validation: [1..1]
</AcctId>		End of Account Identification Mandatory	End of Account Identification Validation: [1..1]
</SchCrit>		End of SearchCriteria Mandatory	End of SearchCriteria Validation: [1..1]
</GetRTGSAccount>		End of Message Type Mandatory	End of Message Type for Static Data Validation: [1..1]
</SspPrtryDt>		End of SSP Proprietary Data Mandatory	End of Root element for all SSP proprietary data Validation: [1..1]
</Data>		End of Proprietary Data Mandatory	Validation: [1..1]
</PrtryData>		End of Proprietary Data Mandatory	End of Proprietary Data Validation: [1..1]
</PrtryMsg>		End proprietary message Mandatory	Validation:

name of attribute	format	short description	description
-------------------	--------	-------------------	-------------

Error Codes:

Order	Error code				Error Text / Validation/ Remark
	SSP	Y-copy	V-shape	XML	
1	X41			1401	Error Text: No permission. RBAC User role(s) are not sufficient. Validation: RBAC role name "APPLICATE", "APPLICBTE", "APPLICSTE" or "APPLIASTE" are required Remark: checked by ICM / ReturnRTGSAccount

GetRTGSAccount_SD_1

Scope: Request information of the RTGS account of a given participant

Name Proprietary message	<PrtryMsg>
Message Header	<MsgHdr>
Message Identification	<MsgId>ABC123</MsgId>
End of Message Header	</MsgHdr>
Proprietary Data	<PrtryData>
Proprietary Data type	<Tp>GetRTGSAccount</Tp>
Proprietary Data	<Data>
SSP Proprietary Data	<SspPrtryDt>
Message Type	<GetRTGSAccount>
SearchCriteria	<SchCrit>
Participant Identification	<PtcptId>
CB Responsible	<Ctry>BE</Ctry>
BIC Participant	<BICPtcpt>ZYAJFRT0BS1</BICPtcpt>
End of Participant Identification	</PtcptId>
Account Identification	<AcctId>
Record Status	<RecSts>AC</RecSts>
End of Account Identification	</AcctId>
End of SearchCriteria	</SchCrit>
End of Message Type	</GetRTGSAccount>
End of SSP Proprietary Data	</SspPrtryDt>
End of Proprietary Data	</Data>
End of Proprietary Data	</PrtryData>
End proprietary message	</PrtryMsg>

6. 5.18 GetSFAccount

SSP Proprietary Messages

GetSFAccount_SD

Scope: Aim :
It is used to get information on SF account.

Precondition :

- The user is logged in and is allowed, thanks to his pre-defined role, to use this transaction.
- The requestor must know precisely the BIC11 identifying the related participant, owner of the SF Account and the responsible Central Bank.
- Data used by requestor to get information on SF Account may be:
–Account status

Postcondition success :

The information on the requested SF account is delivered to the application.

Postcondition failure :

An error message with the relevant error code is issued.

XML Request :

Get SF Account

XML Response :

Return SF Account

<camt.998.001.xx>

Structure:

Name Proprietary message	<PrtryMsg>
Message Header	<MsgHdr>
Message Identification	<MsgId></MsgId>
End of Message Header	</MsgHdr>
End of Proprietary Data	</PrtryData>
Proprietary Data type	<Tp>GetSFAccount</Tp>
Proprietary Data	<Data>
SSP Proprietary Data	<SspPrtryDt>
Message Type	<GetSFAccount>
SearchCriteria	<SchCrit>
Participant Identification	<PtcptId>
CB Responsible	<Ctry></Ctry>
BIC Participant	<BICPtcpt></BICPtcpt>
End of Participant Identification	</PtcptId>
Account Identification	<AcctId>
Record Status	<RecSts></RecSts>
End of Account Identification	</AcctId>
End of SearchCriteria	</SchCrit>
End of Message Type	</GetSFAccount>
End of SSP Proprietary Data	</SspPrtryDt>
End of Proprietary Data	</Data>
End of Proprietary Data	</PrtryData>
End proprietary message	</PrtryMsg>

Attributes:

name of attribute	format	short description	description
<PrtryMsg>		Name Proprietary message Mandatory	Validation:
<MsgHdr>		Message Header Mandatory	Set of characteristics specific to the message Validation: [1..1]
<MsgId>-</MsgId>	35x	Message Identification Mandatory	Message Identification Validation: [1..1]
</MsgHdr>		End of Message Header Mandatory	Validation: [1..1]
</PrtryData>		End of Proprietary Data Mandatory	End of Proprietary Data Validation: [1..1]
<Tp>-</Tp>	35x	Proprietary Data type Mandatory	Proprietary Data type defines the Type of the free format XML Validation: [1..1]
<Data>		Proprietary Data Mandatory	Proprietary data content Validation: [1..1]
<SspPrtryDt>		SSP Proprietary Data Mandatory	Root element for all SSP proprietary data Validation: [1..1]
<GetSFAccount>		Message Type Mandatory	Message Type for Static Data Validation: [1..1]
<SchCrit>		SearchCriteria Mandatory	Defines the criteria used to search for. Validation: [1..1]
<PtcptId>		Participant Identification Mandatory	Participant Identification Validation: [1..1]
<Ctry>-</Ctry>	2!c	CB Responsible Mandatory	Country Code of the Responsible CB. Validation: [1..1]
<BICPtpt>-</BICPtpt>	11x	BIC Participant	A code allocated to a financial institution by a Registration Authority under an international identification scheme, as described in the latest edition of the international standard ISO 9362 "Banking -

name of attribute	format	short description	description
			Banking telecommunication messages - Bank identifier codes". In this case, this is the BIC 11 of a Participant. Mandatory Validation: [1..1]
</PtcptId>		End of Participant Identification Mandatory	End of Participant Identification Validation: [1..1]
<AcctId>		Account Identification Mandatory	Account Identification Validation: [1..1]
<RecSts>-</RecSts>	2x	Record Status	Status of the record. List of values : "AC" for Active "FU" for Future "RE" for Rejected "AR" for Archived "AF" for Archived Future "IC" for In Change "DV" for Delivery (Technical) "ID" for In Deletion (Technical) For more information on status management, refer to the ICM UserHandBook. Mandatory Validation: [1..1]
</AcctId>		End of Account Identification Mandatory	End of Account Identification Validation: [1..1]
</SchCrit>		End of SearchCriteria Mandatory	End of SearchCriteria Validation: [1..1]
</GetSFAccount>		End of Message Type Mandatory	End of Message Type for Static Data Validation: [1..1]
</SspPrtryDt>		End of SSP Proprietary Data Mandatory	End of Root element for all SSP proprietary data Validation: [1..1]
</Data>		End of Proprietary Data Mandatory	Validation: [1..1]
</PrtryData>		End of Proprietary Data Mandatory	End of Proprietary Data Validation: [1..1]
</PrtryMsg>		End proprietary message Mandatory	Validation:

name of attribute	format	short description	description
-------------------	--------	-------------------	-------------

Error Codes:

Order	Error code				Error Text / Validation/ Remark
	SSP	Y-copy	V-shape	XML	
1	X41			1401	Error Text: No permission. RBAC User role(s) are not sufficient. Validation: RBAC role name "APPLICATE", "APPLICSTE" or "APPLICBTE" are required Remark: checked by ICM / ReturnSFAccount

GetSFAccount_SD_1

Scope: Request information of the SF account of a given participant

Name Proprietary message	<PrtryMsg>
Message Header	<MsgHdr>
Message Identification	<Msgld>GETSFACCWB01</Msgld>
End of Message Header	</MsgHdr>
End of Proprietary Data	</PrtryData>
Proprietary Data type	<Tp>GetSFAccount</Tp>
Proprietary Data	<Data>
SSP Proprietary Data	<SspPrtryDt>
Message Type	<GetSFAccount>
SearchCriteria	<SchCrit>
Participant Identification	<Ptcptld>
CB Responsible	<Ctry>ES</Ctry>
BIC Participant	<BICPtcpt>ZYAJFRT0HZ2</BICPtcpt>
End of Participant Identification	</Ptcptld>
Account Identification	<Acctld>
Record Status	<RecSts>AC</RecSts>
End of Account Identification	</Acctld>
End of SearchCriteria	</SchCrit>
End of Message Type	</GetSFAccount>
End of SSP Proprietary Data	</SspPrtryDt>
End of Proprietary Data	</Data>
End of Proprietary Data	</PrtryData>
End proprietary message	</PrtryMsg>

6. 5.19 GetStandingOrderMirror (for Technical account - procedure 6 real-time)

SSP Proprietary Messages

GetStandingOrderMirror_SD

Scope: This message enables the user to request the list of SO Technical accounts - procedure 6 real-time of a specific direct participant by indicating the BIC11 of this participant. The list will be returned via ReturnStandingOrderMirror.

<camt.998.001.xx>

Structure:

Name Proprietary message	<PrtryMsg>
Message Header	<MsgHdr>
Message Identification	<MsgId></MsgId>
End of Message Header	</MsgHdr>
Proprietary Data	<PrtryData>
Proprietary Data type	<Tp>GetStandingOrderMirror</Tp>
Proprietary Data	<Data>
SSP Proprietary Data	<SspPrtryDt>
Message type for static data	<GetStandingOrderMirror>
SearchCriteria	<SchCrit>
Participant Identification	<PtcptId>
BIC Participant	<BICPtcpt></BICPtcpt>
End of Participant Identification	</PtcptId>
End of SearchCriteria	</SchCrit>
Message type for static data (End)	</GetStandingOrderMirror>
End of SSP Proprietary Data	</SspPrtryDt>
End of Proprietary Data	</Data>
End of Proprietary Data	</PrtryData>
End proprietary message	</PrtryMsg>

Attributes:

name of attribute	format	short description	description
<PrtryMsg>		Name Proprietary message Mandatory	Validation:
<MsgHdr>		Message Header Mandatory	Set of characteristics specific to the message Validation: [1..1]
<MsgId>-</MsgId>	35x	Message Identification Mandatory	Message Identification Validation: [1..1]
</MsgHdr>		End of Message Header Mandatory	Validation: [1..1]
<PrtryData>		Proprietary Data Mandatory	Proprietary Data Validation: [1..1]
<Tp>-</Tp>		Proprietary Data type Mandatory	Proprietary Data type Validation: [1..1] Here the value should be GetStandingOrderMirror
<Data>		Proprietary Data Mandatory	Proprietary data content Validation: [1..1]
<SspPrtryDt>		SSP Proprietary Data Mandatory	SSP Proprietary Data Validation: [1..1]
<GetStandingOrderMirror>		Message type for static data Mandatory	Validation: [1..1]
<SchCrit>		SearchCriteria Optional	Validation: [0..1]If not present the BIC for which the standing order is requested will be the work as BIC matching the requestor DN. If there is more than one the message will be rejected (error code X46 se Book 4 chapter 5)
<PtcptId>		Participant Identification Mandatory	Participant Identification Validation: [1..1]
<BICPtcpt>-</BICPtcpt>	11x	BIC Participant	A code allocated to a financial institution by a Registration Authority under an international identification scheme, as described in the latest edition of the international standard ISO 9362 "Banking - Banking telecommunication messages - Bank identifier codes". In this case, this is the BIC 11 of a Participant. BIC11 of the participant for which the SO are requested.

name of attribute	format	short description	description
		Mandatory	If not present the BIC will be the work as BIC matching the requestor DN. Validation: [1..1]
</PtcpId>		End of Participant Identification Mandatory	End of Participant Identification Validation: [1..1]
</SchCrit>		End of SearchCriteria Optional	Validation: [0..1]
</GetStandingOrderMirror>		Message type for static data (End) Mandatory	Validation: [1..1]
</SspPrtryDt>		End of SSP Proprietary Data Mandatory	End of Root element for all SSP proprietary data Validation: [1..1]
</Data>		End of Proprietary Data Mandatory	Validation: [1..1]
</PrtryData>		End of Proprietary Data Mandatory	End of Proprietary Data Validation: [1..1]
</PrtryMsg>		End proprietary message Mandatory	Validation:

Error Codes:

Order	Error code				Error Text / Validation/ Remark
	SSP	Y-copy	V-shape	XML	
1	X41			1401	Error Text: No permission. RBAC User role(s) are not sufficient. Validation: RBAC role name "APPLICATE", "APPLICBTE", "APPLICSTE" or "APPLIASTE" are required Remark: checked by ICM / ReturnStandingOrderMirror

GetStandingOrderMirror_SD_1

Scope: The user request the list of SO Technical accounts- procedure 6 real-time of a specific direct participant by indicating the BIC11 of this participant.

Name Proprietary message	<PrtryMsg>
Message Header	<MsgHdr>
Message Identification	<MsgId>ABC123</MsgId>
End of Message Header	</MsgHdr>
Proprietary Data	<PrtryData>
Proprietary Data type	<Tp>GetStandingOrderMirror</Tp>
Proprietary Data	<Data>
SSP Proprietary Data	<SspPrtryDt>
Message type for static data	<GetStandingOrderMirror>
SearchCriteria	<SchCrit>
Participant Identification	<PtcptId>
BIC Participant	<BICPtcpt>SETTBANKIDT</BICPtcpt>
End of Participant Identification	</PtcptId>
End of SearchCriteria	</SchCrit>
Message type for static data (End)	</GetStandingOrderMirror>
End of SSP Proprietary Data	</SspPrtryDt>
End of Proprietary Data	</Data>
End of Proprietary Data	</PrtryData>
End proprietary message	</PrtryMsg>

6. 5.20 GetStandingOrderSub

SSP Proprietary Messages

GetStandingOrderSub_SD

Scope: This message enables the user to request the list of standing orders to sub accounts of a specific direct participant by indicating the BIC11 of this participant. The list will be returned via ReturnStandingOrderSub.

<camt.998.001.xx>

Structure:

Name Proprietary message	<PrtryMsg>
Message Header	<MsgHdr>
Message Identification	<MsgId></MsgId>
End of Message Header	</MsgHdr>
Proprietary Data	<PrtryData>
Proprietary Data type	<Tp>GetStandingOrderSub</Tp>
Proprietary Data	<Data>
SSP Proprietary Data	<SspPrtryDt>
Message type for static data	<GetStandingOrderSub>
SearchCriteria	<SchCrit>
Participant Identification	<PtcptId>
BIC Participant	<BICPtcpt></BICPtcpt>
End of Participant Identification	</PtcptId>
End of SearchCriteria	</SchCrit>
End of Message type for static data	</GetStandingOrderSub>
End of SSP Proprietary Data	</SspPrtryDt>
End of Proprietary Data	</Data>
End of Proprietary Data	</PrtryData>
End proprietary message	</PrtryMsg>

Attributes:

name of attribute	format	short description	description
<PrtryMsg>		Name Proprietary message Mandatory	Validation: [1..1]
<MsgHdr>		Message Header Mandatory	Set of characteristics specific to the message Validation: [1..1]
<MsgId></MsgId>	35x	Message Identification Mandatory	Message Identification Unique message reference Validation: [1..1]
</MsgHdr>		End of Message Header Mandatory	Validation: [1..1]
<PrtryData>		Proprietary Data Mandatory	Proprietary Data Container of the free format XML Validation: [1..1]
<Tp></Tp>		Proprietary Data type Mandatory	Proprietary Data type Here the value should be GetStandingOrderSub Validation: [1..1]
<Data>		Proprietary Data Mandatory	Proprietary data content Validation: [1..1]
<SspPrtryDt>		SSP Proprietary Data Mandatory	SSP Proprietary Data Validation: [1..1]
<GetStandingOrderSub>		Message type for static data Mandatory	Message type for static data Validation: [1..1]
<SchCrit>		SearchCriteria Optional	Defines the criteria used to search for. If not present the BIC for which the standing order is requested will be the work as BIC matching the requestor DN. If there is more than one the message will be rejected. Validation: [0..1]
<PtcptId>		Participant Identification Mandatory	Participant Identification Validation: [1..1]
<BICPtcpt></BICPtcpt>	11x	BIC Participant	A code allocated to a financial institution by a Registration Authority under an international identification scheme, as described in the latest edition of the international standard ISO 9362 "Banking - Banking telecommunication messages - Bank identifier codes".

name of attribute	format	short description	description
			In this case, this is the BIC 11 of a Participant. BIC11 of the participant for which the SO are requested. Validation: [1..1]
</PtcptId>		End of Participant Identification Mandatory	End of Participant Identification Validation: [1..1]
</SchCrit>		End of SearchCriteria Optional	Validation: [0..1]
</GetStandingOrderSub>		End of Message type for static data Mandatory	End of Message type for static data Validation: [1..1]
</SspPrtryDt>		End of SSP Proprietary Data Mandatory	End of SSP Proprietary Data Validation: [1..1]
</Data>		End of Proprietary Data Mandatory	Validation: [1..1]
</PrtryData>		End of Proprietary Data Mandatory	End of Proprietary Data Container of the free format XML Validation: [1..1]
</PrtryMsg>		End proprietary message Mandatory	Validation: [1..1]

Error Codes:

Order	Error code				Error Text / Validation/ Remark
	SSP	Y-copy	V-shape	XML	
1	X41			1401	<p>Error Text: No permission. RBAC User role(s) are not sufficient.</p> <p>Validation: RBAC role name "APPLICATE", "APPLICBTE" or "APPLICSTE" are required</p> <p>Remark: checked by ICM / ReturnStandingOrderSub</p>
2	P53			P053	<p>Error Text: RTGS account does not exist or is not valid</p> <p>Validation: PtcptId/BICPtcpt value must indicate a SSP participant (BIC of the RTGS account has to be valid)</p> <p>Remark: checked by ICM / ReturnStandingOrderSub</p>
3	X42			1402	<p>Error Text: No authorisation. User is not allowed acting on behalf of another participant.</p> <p>Validation: PtcptId/BICPtcpt (profile credit institution) value must indicate the credit institution itself or a participant who the credit institution is entitled to act on behalf of</p> <p>Remark: checked by ICM / ReturnStandingOrderSub</p>
4	X45			1405	<p>Error Text: No authorisation or rather interaction not possible. User is not allowed acting on behalf of another participant as Group of Account manager</p> <p>Validation: PtcptId/BICPtcpt (profile group of accounts manager) value must indicate the group of accounts manager himself</p> <p>Remark: checked by ICM / ReturnStandingOrderSub</p>
5	X47			1407	<p>Error Text: No authorisation. User is not allowed acting on behalf of another Participant as Central Bank</p> <p>Validation: PtcptId/BICPtcpt (profile central bank) value must indicate the central bank itself or a participant the central bank is responsible for</p> <p>Remark: checked by ICM / ReturnStandingOrderSub</p>

GetStandingOrderSub_SD_1

Scope: Request for list of SO sub accounts. Sending party and Account Owner are identical.

Name Proprietary message	<PrtryMsg>
Message Header	<MsgHdr>
Message Identification	<MsgId>ABC123</MsgId>
End of Message Header	</MsgHdr>
Proprietary Data	<PrtryData>
Proprietary Data type	<Tp>GetStandingOrderSub</Tp>
Proprietary Data	<Data>
SSP Proprietary Data	<SspPrtryDt>
Message type for static data	<GetStandingOrderSub/>
End of SSP Proprietary Data	</SspPrtryDt>
End of Proprietary Data	</Data>
End of Proprietary Data	</PrtryData>
End proprietary message	</PrtryMsg>

GetStandingOrderSub_SD_2

Scope: Request for SO sub accounts on behalf of third party (AccountOwner) e.g. BIC of NCB or GoA manager is the Sender of the GetAccount message. Sending party and AccountOwner are different.

Name Proprietary message	<PrtryMsg>
Message Header	<MsgHdr>
Message Identification	<MsgId>ABC123</MsgId>
End of Message Header	</MsgHdr>
Proprietary Data	<PrtryData>
Proprietary Data type	<Tp>GetStandingOrderSub</Tp>
Proprietary Data	<Data>
SSP Proprietary Data	<SspPrtryDt>
Message type for static data	<GetStandingOrderSub>
SearchCriteria	<SchCrit>
Participant Identification	<PtcptId>
BIC Participant	<BICPtcpt>SETTBANKIDT</BICPtcpt>
End of Participant Identification	</PtcptId>
End of SearchCriteria	</SchCrit>
End of Message type for static data	</GetStandingOrderSub>
End of SSP Proprietary Data	</SspPrtryDt>
End of Proprietary Data	</Data>
End of Proprietary Data	</PrtryData>
End proprietary message	</PrtryMsg>

6. 5.21 GetStandingOrder

Cash Management Standard

GetStandingOrder_SD

M

Scope: This message enables the user to request the list of Standing Orders to DCAs or TIPS accounts of a specific RTGS account by indicating the number of this account. The list will be returned via ReturnStandingOrder.

The GetStandingOrder message can be sent by the application of a direct PM participant or the application of a group of accounts manager.

It is a standard XML message <camt.069.001.xx>

Structure:

Message type	<GetStgOrd>
Message Header	<MsgHdr>
Message Identification	<MsgId></MsgId>
End of Message Header	</MsgHdr>
StandingOrderQuery	<StgOrdQryDef>
StandingOrderCriteria1Choice	<StgOrdCrit>
Query Type	<QryNm></QryNm>
NewCriteria	<NewCrit>
SearchCriteria	<SchCrit>
Account Identification	<Acct>
Identification	<Id>
GenericAccountIdentification	<Othr>
Identification	<Id></Id>
End of GenericAccountIdentification	</Othr>
End Identification	</Id>
End of Account	</Acct>
End of SearchCriteria	</SchCrit>
End of NewCriteria	</NewCrit>
End of StandingOrderCriteria1Choice	</StgOrdCrit>
End of StandingOrderQuery	</StgOrdQryDef>
End of Message type	</GetStgOrd>

A

Attributes:

name of attribute	format	short description	description
<GetStgOrd>		Message type Optional	Message type Validation: [1..1]
<MsgHdr>		Message Header Mandatory	Set of characteristics specific to the message Validation: [1..1]
<MsgId>-</MsgId>	35x	Message Identification Mandatory	Message Identification Validation: [1..1]
</MsgHdr>		End of Message Header Mandatory	Validation: [1..1]
<StgOrdQryDef>		StandingOrderQuery Mandatory	Validation: [1..1]
<StgOrdCrit>		StandingOrderCriteria1Choice Mandatory	Validation: [1..1]
<QryNm>-</QryNm>	4x	Query Type Mandatory	needed to define T2S or TIPS Standing Order T2S = Standing Order for T2S TIPS = Standing Order for TIPS needed to define T2S or TIPS Standing Order T2S = Standing Order for T2S TIPS = Standing Order for TIPS Validation: [1..1]Only "T2S" or "TIPS" allowed
<NewCrit>		NewCriteria Mandatory	Validation: [1..1]
<SchCrit>		SearchCriteria Mandatory	Defines the criteria used to search for. differs from the SWIFT standard Validation: [1..1]
<Acct>		Account Identification Mandatory	Validation: [1..1]
<Id>		Identification Mandatory	Identification Validation: [1..1]
<Othr>		GenericAccountIdentification Mandatory	GenericAccountIdentification Validation: [1..1]
<Id>-</Id>	34x	Identification	Name or number assigned by an entity to enable recognition of that entity, eg, account identifier. RTGS account number

name of attribute	format	short description	description
		Mandatory	Validation: [1..1]
</Othr>		End of GenericAccountIdentificatio n Mandatory	End of GenericAccountIdentification Validation: [1..1]
</Id>		End Identification Mandatory	End Identification Validation: [1..1]
</Acct>		End of Account Mandatory	Validation: [1..1]
</SchCrit>		End of SearchCriteria Mandatory	End of SearchCriteria Validation: [1..1]
</NewCrit>		End of NewCriteria Mandatory	End of NewCriteria Validation: [1..1]
</StgOrdrCrit>		End of StandingOrderCriteria1Choi ce Mandatory	Validation: [1..1]
</StgOrdrQryDef>		End of StandingOrderQuery Mandatory	Validation: [1..1]
</GetStgOrdr>		End of Message type Optional	End of Message type Validation:

Error Codes:

Order	Error code				Error Text / Validation/ Remark
	SSP	Y-copy	V-shape	XML	
	X66	TL		1426	Error Text: The TIPS Account must be linked to a RTGS account related to the sender. A Validation: IF TIPS Account is not linked to RTGS Account of the sender Remark:
1	X41			1401	Error Text: No permission. RBAC User role(s) are not sufficient. Validation: RBAC role name "APPLICATE", "APPLICBTE", "APPLICSTE" or "APPLIASTE" are required Remark: checked by ICM / ReturnStandingOrderDCA
2	T56	T6		T056	Error Text: Message type not supported. Validation: IF SSP parameter SWITCH_T2S_SD = Off Remark:

GetStandingOrder_SD_1

M

Scope: GetStandingOrder Message sent to receive a list with all SO to T2S DCA for the participants RTGS account RTGSBE3456789122345678323456789123.

Message type	<GetStgOrdr>
Message Header	<MsgHdr>
Message Identification	<MsgId>ABC123</MsgId>
End of Message Header	</MsgHdr>
StandingOrderQuery	<StgOrdrQryDef>
StandingOrderCriteria1Choice	<StgOrdrCrit>
Query Type	<QryNm>T2S</QryNm>
NewCriteria	<NewCrit>
SearchCriteria	<SchCrit>
Account Identification	<Acct>
Identification	<Id>
GenericAccountIdentification	<Othr>
Identification	<Id>RTGSBE3456789122345678323456789123</Id>
End of GenericAccountIdentification	</Othr>
End Identification	</Id>
End of Account	</Acct>
End of SearchCriteria	</SchCrit>
End of NewCriteria	</NewCrit>
End of StandingOrderCriteria1Choice	</StgOrdrCrit>
End of StandingOrderQuery	</StgOrdrQryDef>
End of Message type	</GetStgOrdr>

A

GetStandingOrder_SD_2

A

Scope: GetStandingOrder Message sent to receive a list with all SO to TIPS for the participants RTGS account RTGSBE3456789122345678323456789123.

Message type	<GetStgOrdr>	A
Message Header	<MsgHdr>	A
Message Identification	<MsgId>ABC123</MsgId>	A
End of Message Header	</MsgHdr>	A
StandingOrderQuery	<StgOrdrQryDef>	A
StandingOrderCriteria1Choice	<StgOrdrCrit>	A
Query Type	<QryNm>TIPS</QryNm>	A
NewCriteria	<NewCrit>	A
SearchCriteria	<SchCrit>	A
Account Identification	<Acct>	A
Identification	<Id>	A
GenericAccountIdentification	<Othr>	A
Identification	<Id>RTGSBE3456789122345678323456789123</Id>	A
End of GenericAccountIdentification	</Othr>	A
End Identification	</Id>	A
End of Account	</Acct>	A
End of SearchCriteria	</SchCrit>	A
End of NewCriteria	</NewCrit>	A
End of StandingOrderCriteria1Choice	</StgOrdrCrit>	A
End of StandingOrderQuery	</StgOrdrQryDef>	A
End of Message type	</GetStgOrdr>	A

6. 5.22 GetSubAccount

SSP Proprietary Messages

GetSubAccount_SD

Scope: Aim :
It is used to get information on sub account.

Precondition :

- The user is logged in and is allowed, thanks to his pre-defined role, to use this transaction.
- The requestor must know precisely the BIC11 identifying the related participant, owner of the sub account and the responsible Central Bank.
- Data used by requestor to get information on sub account may be:
 - Account status
 - Modification date (ie activation date of modification)

Postcondition success :
The information on the requested sub-account is delivered to the application.

Postcondition failure :
An error message with the relevant error code is issued.

XML Request :
Get sub account

XML Response :
Return sub account

<camt.998.001.xx>

Structure:

Name Proprietary message	<PrtryMsg>
Message Header	<MsgHdr>
Message Identification	<MsgId></MsgId>
End of Message Header	</MsgHdr>
Proprietary Data	<PrtryData>
Proprietary Data type	<Tp>GetSubAccount</Tp>
Proprietary Data	<Data>
SSP Proprietary Data	<SspPrtryDt>
Message Type	<GetSubAccount>
SearchCriteria	<SchCrit>
Participant Identification	<PtcptId>
CB Responsible	<Ctry></Ctry>
BIC Participant	<BICPtcpt></BICPtcpt>
End of Participant Identification	</PtcptId>
Account Identification	<AcctId>
Record Status	<ListOfSts></ListOfSts>
DateSearchChoice	<DtSch>
choice	<xorFrDtToDtFrToDt>
Date From	<FrDt></FrDt>
Date Till	<ToDt></ToDt>
FromToDate	<FrToDt>
Date From	<FrDt></FrDt>
Date Till	<ToDt></ToDt>
End FromToDate	</FrToDt>
End of choice	</xorFrDtToDtFrToDt>
End of Date Search	</DtSch>
End of Account Identification	</AcctId>
End of SearchCriteria	</SchCrit>
End of Message Type	</GetSubAccount>

End of SSP Proprietary Data
End of Proprietary Data
End of Proprietary Data
End proprietary message

```
| | | </SspPrtryDt>  
| | </Data>  
| </PrtryData>  
</PrtryMsg>
```

Attributes:

name of attribute	format	short description	description
<PrtryMsg>		Name Proprietary message Mandatory	Validation:
<MsgHdr>		Message Header Mandatory	Set of characteristics specific to the message Validation: [1..1]
<MsgId>-</MsgId>	35x	Message Identification Mandatory	Message Identification Validation: [1..1]
</MsgHdr>		End of Message Header Mandatory	Validation: [1..1]
<PrtryData>		Proprietary Data Mandatory	Proprietary Data Validation: [1..1]
<Tp>-</Tp>	35x	Proprietary Data type Mandatory	Proprietary Data type defines the Type of the free format XML Validation: [1..1]
<Data>		Proprietary Data Mandatory	Proprietary data content Validation: [1..1]
<SspPrtryDt>		SSP Proprietary Data Mandatory	Root element for all SSP proprietary data Validation: [1..1]
<GetSubAccount>		Message Type Mandatory	Message Type for Static Data Validation: [1..1]
<SchCrit>		SearchCriteria Mandatory	Defines the criteria used to search for. Validation: [1..1]
<PtcptId>		Participant Identification Mandatory	Participant Identification Validation: [1..1]
<Ctry>-</Ctry>	2lc	CB Responsible Mandatory	Country Code of the Responsible CB. Validation: [1..1]
<BICPtpt>-</BICPtpt>	11x	BIC Participant	A code allocated to a financial institution by a Registration Authority under an international identification scheme, as described in the latest edition of the international standard ISO 9362 "Banking -

name of attribute	format	short description	description
			Banking telecommunication messages - Bank identifier codes". In this case, this is the BIC 11 of a Participant. Mandatory Validation: [1..1]
</Pcptld>		End of Participant Identification Mandatory	End of Participant Identification Validation: [1..1]
<Acctld>		Account Identification Mandatory	Account Identification Validation: [1..1]
<ListOfSts>-</ListOfSts>	2x	Record Status Mandatory	List of values : "AC" for Active + In deletion (technical) + In Delivery (technical) "FU" for Future "AR" for Archived + Archived Future + Rejected "IC" for In change "AL" for all statuses "AF" for Active + In deletion (technical) + Future + In Delivery (technical) For more information on status, please read the ICM UserHandBook. Validation: [1..1]
<DtSch>		DateSearchChoice Optional	A choice between search criteria based on dates and date ranges. Validation: [0..1]
xorFrDtToDtFrToDt		choice Optional	choice amongst <FrDt>, <ToDt> or <FrToDt> Validation:
<FrDt>-</FrDt>	ISODate	Date From Optional	Date within a particular calendar year represented by YYYY-MM-DD (ISO 8601). Validation: [0..1]
<ToDt>-</ToDt>	ISODate	Date Till Optional	Date within a particular calendar year represented by YYYY-MM-DD (ISO 8601). Validation: [0..1]
<FrToDt>		FromToDate Optional	A particular time span specified between a start date and an end date. Validation: [0..1]
<FrDt>-</FrDt>	ISODate	Date From Optional	Date within a particular calendar year represented by YYYY-MM-DD (ISO 8601). Validation: [0..1]

name of attribute	format	short description	description
<ToDt>-</ToDt>	ISODate	Date Till	Date within a particular calendar year represented by YYYY-MM-DD (ISO 8601).
		Optional	Validation: [0..1]
</FrToDt>		End FromToDate	End of a particular time span specified between a start date and an end date.
		Optional	Validation: [0..1]
/xorFrDtToDtFrToDt		End of choice	end of choice amongst <FrDt>, <ToDt> or <FrToDt>
		Optional	Validation:
</DtSch>		End of Date Search	End of Date Search
		Optional	Validation: [0..1]
</AcctId>		End of Account Identification	End of Account Identification
		Mandatory	Validation: [1..1]
</SchCrit>		End of SearchCriteria	End of SearchCriteria
		Mandatory	Validation: [1..1]
</GetSubAccount>		End of Message Type	End of Message Type for Static Data
		Mandatory	Validation: [1..1]
</SspPrtryDt>		End of SSP Proprietary Data	End of Root element for all SSP proprietary data
		Mandatory	Validation: [1..1]
</Data>		End of Proprietary Data	
		Mandatory	Validation: [1..1]
</PrtryData>		End of Proprietary Data	End of Proprietary Data
		Mandatory	Validation: [1..1]
</PrtryMsg>		End proprietary message	
		Mandatory	Validation:

Error Codes:

Order	Error code				Error Text / Validation/ Remark
	SSP	Y-copy	V-shape	XML	
1	X41			1401	Error Text: No permission. RBAC User role(s) are not sufficient. Validation: RBAC role name "APPLICATE", "APPLICBTE", "APPLICSTE" or "APPLIASTE" are required Remark: checked by ICM / ReturnSubAccount

GetSubAccount_SD_1

Scope: Get information on the Sub Account of the Participant ZYAJFRT0BS1 from Date From to Date Till

Name Proprietary message	<PrtryMsg>
Message Header	<MsgHdr>
Message Identification	<MsgId>GetSubAcct DateFrom to DateTill</MsgId>
End of Message Header	</MsgHdr>
Proprietary Data	<PrtryData>
Proprietary Data type	<Tp>GetSubAccount</Tp>
Proprietary Data	<Data>
SSP Proprietary Data	<SspPrtryDt>
Message Type	<GetSubAccount>
SearchCriteria	<SchCrit>
Participant Identification	<PtcptId>
CB Responsible	<Ctry>BE</Ctry>
BIC Participant	<BICPtcpt>ZYAJFRT0BS1</BICPtcpt>
End of Participant Identification	</PtcptId>
Account Identification	<AcctId>
Record Status	<ListOfSts>AC</ListOfSts>
DateSearchChoice	<DtSch>
FromToDate	<FrToDate>
Date From	<FrDt>2007-01-02</FrDt>
Date Till	<ToDt>20012-03-13</ToDt>
End FromToDate	</FrToDate>
End of Date Search	</DtSch>
End of Account Identification	</AcctId>
End of SearchCriteria	</SchCrit>
End of Message Type	</GetSubAccount>
End of SSP Proprietary Data	</SspPrtryDt>
End of Proprietary Data	</Data>
End of Proprietary Data	</PrtryData>
End proprietary message	</PrtryMsg>

GetSubAccount_SD_2

Scope: Get information on the Sub Account of the Participant ZYAJFRT0BS1 for Date From only

Name Proprietary message	<PrtryMsg>
Message Header	<MsgHdr>
Message Identification	<MsgId>GetSubAcct DateFrom</MsgId>
End of Message Header	</MsgHdr>
Proprietary Data	<PrtryData>
Proprietary Data type	<Tp>GetSubAccount</Tp>
Proprietary Data	<Data>
SSP Proprietary Data	<SspPrtryDt>
Message Type	<GetSubAccount>
SearchCriteria	<SchCrit>
Participant Identification	<PtcptId>
CB Responsible	<Ctry>BE</Ctry>
BIC Participant	<BICPtcpt>ZYAJFRT0BS1</BICPtcpt>
End of Participant Identification	</PtcptId>
Account Identification	<AcctId>
Record Status	<ListOfSts>AC</ListOfSts>
DateSearchChoice	<DtSch>
Date From	<FrDt>2007-01-02</FrDt>
End of Date Search	</DtSch>
End of Account Identification	</AcctId>
End of SearchCriteria	</SchCrit>
End of Message Type	</GetSubAccount>
End of SSP Proprietary Data	</SspPrtryDt>
End of Proprietary Data	</Data>
End of Proprietary Data	</PrtryData>
End proprietary message	</PrtryMsg>

GetSubAccount_SD_3

Scope: Get information on the Sub Account of the Participant ZYAJFRT0BS1 for Date Till only

Name Proprietary message	<PrtryMsg>
Message Header	<MsgHdr>
Message Identification	<Msgld>GetSubAcct DateTill</Msgld>
End of Message Header	</MsgHdr>
Proprietary Data	<PrtryData>
Proprietary Data type	<Tp>GetSubAccount</Tp>
Proprietary Data	<Data>
SSP Proprietary Data	<SspPrtryDt>
Message Type	<GetSubAccount>
SearchCriteria	<SchCrit>
Participant Identification	<Ptcptld>
CB Responsible	<Ctry>BE</Ctry>
BIC Participant	<BICPtcpt>ZYAJFRT0BS1</BICPtcpt>
End of Participant Identification	</Ptcptld>
Account Identification	<Acctld>
Record Status	<ListOfSts>AC</ListOfSts>
DateSearchChoice	<DtSch>
Date Till	<ToDt>20012-03-13</ToDt>
End of Date Search	</DtSch>
End of Account Identification	</Acctld>
End of SearchCriteria	</SchCrit>
End of Message Type	</GetSubAccount>
End of SSP Proprietary Data	</SspPrtryDt>
End of Proprietary Data	</Data>
End of Proprietary Data	</PrtryData>
End proprietary message	</PrtryMsg>

6. 5.23 GetT2Wildcard

SSP Proprietary Messages

GetT2Wildcard_SD

Scope: Aim :
It is used to get information on TARGET2 wildcard.

Precondition :

- The user is logged in and is allowed, thanks to his pre-defined role, to use this transaction.
- The requestor must know precisely the BIC11 identifying the related participant and the responsible Central Bank.
- Data used by requestor to get information on TARGET2 wildcard may be:
–TARGET2 wildcard status

Postcondition success :
The information on the requested TARGET2 wildcard is delivered to the application.

Postcondition failure :
An error message with the relevant error code is issued.

XML Request :
Get T2WildCard

XML Response :
Return T2WildCard

<camt.998.001.xx>

Structure:

Name Proprietary message	<PrtryMsg>
Message Header	<MsgHdr>
Message Identification	<MsgId></MsgId>
End of Message Header	</MsgHdr>
Proprietary Data	<PrtryData>
Proprietary Data type	<Tp>GetT2Wildcard</Tp>
Proprietary Data	<Data>
SSP Proprietary Data	<SspPrtryDt>
Message Type	<GetT2Wildcard>
SearchCriteria	<SchCrit>
Participant Identification	<PtcptId>
CB Responsible	<Ctry></Ctry>
BIC Participant	<BICPtcpt></BICPtcpt>
End of Participant Identification	</PtcptId>
T2WildCard Identification	<WCardId>
Record Status	<RecSts></RecSts>
Type	<WCardTp></WCardTp>
End of T2WildCard Identification	</WCardId>
End of SearchCriteria	</SchCrit>
End of Message Type	</GetT2Wildcard>
End of SSP Proprietary Data	</SspPrtryDt>
End of Proprietary Data	</Data>
End of Proprietary Data	</PrtryData>
End proprietary message	</PrtryMsg>

Attributes:

name of attribute	format	short description	description
<PrtryMsg>		Name Proprietary message Mandatory	Validation:
<MsgHdr>		Message Header Mandatory	Set of characteristics specific to the message Validation: [1..1]
<MsgId>-</MsgId>	35x	Message Identification Mandatory	Message Identification Validation: [1..1]
</MsgHdr>		End of Message Header Mandatory	Validation: [1..1]
<PrtryData>		Proprietary Data Mandatory	Proprietary Data Validation: [1..1]
<Tp>-</Tp>	35x	Proprietary Data type Mandatory	Proprietary Data type defines the Type of the free format XML Validation: [1..1]
<Data>		Proprietary Data Mandatory	Proprietary data content Validation: [1..1]
<SspPrtryDt>		SSP Proprietary Data Mandatory	Root element for all SSP proprietary data Validation: [1..1]
<GetT2Wildcard>		Message Type Mandatory	Message Type for Static Data Validation: [1..1]
<SchCrit>		SearchCriteria Mandatory	Defines the criteria used to search for. Validation: [1..1]
<PtcptId>		Participant Identification Mandatory	Participant Identification Validation: [1..1]
<Ctry>-</Ctry>	2lc	CB Responsible Mandatory	Country Code of the Responsible CB. Validation: [1..1]
<BICPtct>-</BICPtct>	11x	BIC Participant	A code allocated to a financial institution by a Registration Authority under an international identification scheme, as described in the latest edition of the international standard ISO 9362 "Banking -

name of attribute	format	short description	description
			Banking telecommunication messages - Bank identifier codes". In this case, this is the BIC 11 of a Participant. Mandatory Validation: [1..1]
</PtcptId>		End of Participant Identification Mandatory	End of Participant Identification Validation: [1..1]
<WCardId>		T2WildCard Identification Mandatory	T2WildCard Identification Validation: [1..1]
<RecSts>-</RecSts>	2x	Record Status Mandatory	Status of the record. List of values : "AC" for Active "FU" for Future "RE" for Rejected "AR" for Archived "AF" for Archived Future "IC" for In Change "DV" for Delivery (Technical) "ID" for In Deletion (Technical) For more information on status management, refer to the ICM UserHandBook. Validation: [1..1]
<WCardTp>-</WCardTp>	1!a	Type Mandatory	Flag indicating whether the rule is included or excluded. Values may be : 'I' for Inclusion 'E' for Exclusion 'A' for getting all type of Wildcard (used for 'Get' XML Message). Validation: [1..1]
<WCardId>		End of T2WlidCard Identification Mandatory	End of T2WlidCard Identification Validation: [1..1]
</SchCrit>		End of SearchCriteria Mandatory	End of SearchCriteria Validation: [1..1]
</GetT2Wildcard>		End of Message Type Mandatory	End of Message Type for Static Data Validation: [1..1]
</SspPrtryDt>		End of SSP Proprietary Data Mandatory	End of Root element for all SSP proprietary data Validation: [1..1]
</Data>		End of Proprietary Data Mandatory	Validation:

name of attribute	format	short description	description
			[1..1]
</PrtryData>		End of Proprietary Data	End of Proprietary Data
		Mandatory	Validation: [1..1]
</PrtryMsg>		End proprietary message	
		Mandatory	Validation:

Error Codes:

Order	Error code				Error Text / Validation/ Remark
	SSP	Y-copy	V-shape	XML	
1	X41			1401	Error Text: No permission. RBAC User role(s) are not sufficient. Validation: RBAC role name "APPLICATE", "APPLICSTE" or "APPLICBTE" are required Remark: checked by ICM / ReturnT2Wildcard

GetT2Wildcard_SD_1

Scope: Request to get information on the TARGET2 wildcard of a given participant

Name Proprietary message	<PrtryMsg>
Message Header	<MsgHdr>
Message Identification	<MsgId>ABC123</MsgId>
End of Message Header	</MsgHdr>
Proprietary Data	<PrtryData>
Proprietary Data type	<Tp>GetT2Wildcard</Tp>
Proprietary Data	<Data>
SSP Proprietary Data	<SspPrtryDt>
Message Type	<GetT2Wildcard>
SearchCriteria	<SchCrit>
Participant Identification	<PtcptId>
CB Responsible	<Ctry>BE</Ctry>
BIC Participant	<BICPtcpt>ZYAJFRT0BS1</BICPtcpt>
End of Participant Identification	</PtcptId>
T2WildCard Identification	<WCardId>
Record Status	<RecSts>FU</RecSts>
Type	<WCardTp>A</WCardTp>
End of T2WlidCard Identification	</WCardId>
End of SearchCriteria	</SchCrit>
End of Message Type	</GetT2Wildcard>
End of SSP Proprietary Data	</SspPrtryDt>
End of Proprietary Data	</Data>
End of Proprietary Data	</PrtryData>
End proprietary message	</PrtryMsg>

6. 5.24 ModifyHAMAccount (for CBs only)

SSP Proprietary Messages

ModifyHAMAccount_SD

Scope: Aim :
It is used to create or modify HAM account.

Precondition :

- The user is logged in and is allowed, thanks to his pre-defined role, to use this transaction.
- The requestor must know precisely the BIC11 identifying the related participant, owner of the HAM account and the responsible CB.
- Data used by requestor to enter or modify information on HAM account may be:
 - Update Flag
 - HAM account Number
 - HAM account type
 - Notification BIC
 - Notification MT 202 (flag Y/N)
 - Notification MT 900 (flag Y/N)
 - Notification MT 910 (flag Y/N)
 - Balance Report
 - BIC of the co-manager
 - Activation date of the update

XML Request :
Modify HAM Account

XML Response :
Receipt

<camt.998.001.xx>

Structure:

Name Proprietary message	<PrtryMsg>
Message Header	<MsgHdr>
Message Identification	<MsgId></MsgId>
End of Message Header	</MsgHdr>
Proprietary Data	<PrtryData>
Proprietary Data type	<Tp>ModifyHAMAccount</Tp>
Proprietary Data	<Data>
SSP Proprietary Data	<SspPrtryDt>
Message Type	<ModifyHAMAccount>
HAM Account	<HamAcct>
CB Responsible	<Ctry></Ctry>
BIC	<BIC></BIC>
Record Status all Modify and Delete messages	<RecSts></RecSts>
Account Information	<AcctInf>
Update Flag	<UpdtFlag></UpdtFlag>
HAM Account Number	<HamAcctNb></HamAcctNb>
HAM Account Type	<HamAcctTp></HamAcctTp>
Notification BIC	<NtfctnBIC></NtfctnBIC>
Accept MT202 Notify	<Ntfctn202LqdyTrf></Ntfctn202LqdyTrf>
Accept MT900 Notify	<Ntfctn900></Ntfctn900>
Accept MT910 Notify	<Ntfctn910></Ntfctn910>
Balance Report	<BalRpt></BalRpt>
BIC Co Manager	<CmngrBIC></CmngrBIC>
Activation Date	<ActDt></ActDt>
End of Account Information	</AcctInf>
End of HAM Account	</HamAcct>
End of Message Type	</ModifyHAMAccount>

End of SSP Proprietary Data
End of Proprietary Data
End of Proprietary Data
End proprietary message

```
| | | </SspPrtryDt>  
| | </Data>  
| </PrtryData>  
</PrtryMsg>
```

Attributes:

name of attribute	format	short description	description
<PrtryMsg>		Name Proprietary message Mandatory	Validation:
<MsgHdr>		Message Header Mandatory	Set of characteristics specific to the message Validation: [1..1]
<MsgId>-</MsgId>	35x	Message Identification Mandatory	Message Identification Validation: [1..1]
</MsgHdr>		End of Message Header Mandatory	Validation: [1..1]
<PrtryData>		Proprietary Data Mandatory	Proprietary Data Validation: [1..1]
<Tp>-</Tp>	35x	Proprietary Data type Mandatory	Proprietary Data type defines the Type of the free format XML Validation: [1..1]
<Data>		Proprietary Data Mandatory	Proprietary data content Validation: [1..1]
<SspPrtryDt>		SSP Proprietary Data Mandatory	Root element for all SSP proprietary data Validation: [1..1]
<ModifyHAMAccount>		Message Type Mandatory	Message Type for Static Data Validation: [1..1]
<HamAcct>		HAM Account Mandatory	HAM Account Validation: [1..1]
<Ctry>-</Ctry>	2!c	CB Responsible Mandatory	Country Code of the Responsible CB. Validation: [1..1]
<BIC>-</BIC>	4!a2!a2!c3!c	BIC Mandatory	A code allocated to a financial institution by a Registration Authority under an international identification scheme, as described in the latest edition of the international standard ISO 9362 "Banking - Banking telecommunication messages - Bank identifier codes". BIC 11 of the HAM Account Holder (BIC Participant) Validation: [1..1]

name of attribute	format	short description	description
<RecSts>-</RecSts>	2x	Record Status all Modify and Delete messages	Status of the record. List of values : "AC" for Active "FU" for Future "IC" for In Change For more information on status management, please read the ICM UserHandBook. Optional Validation: [0..1] If Update Flag is equal to N then the <RecSts> is optional. If Update Flag is equal to U then the <RecSts> is mandatory.
<AcctInf>		Account Information Mandatory	Account Information Validation: [1..1]
<UpdtFlag>-</UpdtFlag>	1!a	Update Flag Mandatory	Flag used in "Modify" XML Message to indicate the type of update : "N" for new entry "U" for update of an existing entry Validation: [1..1]
<HamAcctNb>-</HamAcctNb>	2!c32x	HAM Account Number Mandatory	Account Number. Length 34 characters. The first two characters represent the country code of the responsible CB. The Account Number is unique within the HAM. Validation: [1..1]
<HamAcctTp>-</HamAcctTp>	3x	HAM Account Type Mandatory	Indicates the type of HAM Account. Values may be : "SU" for normal HAM Account "CB" for CB HAM Account "CU" for CB Customer Account "LB" for CB Customer Liquidity Bridge Account (technical) "SFI" for Standing Facilities Interests Account (technical) "RIP" for RM interests and penalty Account (technical) "HAI" for HAM Interests Account (technical) "T2F" for Target 2 Fees Account (technical) Validation: [1..1]
<NtfctnBIC>-</NtfctnBIC>	4!a2!a2!c3!c]	Notification BIC Optional	A code allocated to a financial institution by a Registration Authority under an international identification scheme, as described in the latest edition of the international standard ISO 9362 "Banking - Banking telecommunication messages - Bank identifier codes". In this case, this is the BIC used for all notification messages in HAM. Validation: [0..1]
<Ntfctn202LqdyTrf>-</Ntfctn202LqdyTrf>	1!a	Accept MT202 Notify	For HAM Account in case of liquidity transfer : A flag with two values : 'Y' or 'N'. This flag indicates that the participant has chosen to receive MT202 in case of liquidity transfer

name of attribute	format	short description	description
		Optional	Validation: [0..1]
<Ntfctn900>-</Ntfctn900>	1!a	Accept MT900 Notify	For HAM Account : A flag with two values : 'Y' or 'N'. This flag indicates that the participant has chosen to receive MT900 for each debit
		Mandatory	Validation: [1..1]
<Ntfctn910>-</Ntfctn910>	1!a	Accept MT910 Notify	A flag with two values : 'Y' or 'N'. This flag indicates that the participant has chosen to receive MT910 for each credit.
		Mandatory	Validation: [1..1]
<BalRpt>-</BalRpt>	3!n	Balance Report	This is the Swift message type for Balance Report. List of values : "940", "950" or "none"
		Mandatory	Validation: [1..1]
<CmngnrBIC>-</CmngnrBIC>	11x	BIC Co Manager	A code allocated to a financial institution by a Registration Authority under an international identification scheme, as described in the latest edition of the international standard ISO 9362 "Banking - Banking telecommunication messages - Bank identifier codes". In this case, this is the BIC 11 of the Co Manager (Participant BIC).
		Optional	Validation: [0..1]
<ActDt>-</ActDt>	ISODate	Activation Date	Date within a particular calendar year represented by YYYY-MM-DD (ISO 8601).
		Mandatory	Validation: [1..1]
</AcctInf>		End of Account Information	End of Account Information
		Mandatory	Validation: [1..1]
</HamAcct>		End of HAM Account	End of HAM Account
		Mandatory	Validation: [1..1]
</ModifyHAMAccount>		End of Message Type	End of Message Type for Static Data
		Mandatory	Validation: [1..1]
</SspPrtryDt>		End of SSP Proprietary Data	End of Root element for all SSP proprietary data
		Mandatory	Validation: [1..1]
</Data>		End of Proprietary Data	
		Mandatory	Validation: [1..1]

name of attribute	format	short description	description
</PrtryData>		End of Proprietary Data	End of Proprietary Data
		Mandatory	Validation: [1..1]
</PrtryMsg>		End proprietary message	
		Mandatory	Validation:

Error Codes:

Order	Error code				Error Text / Validation/ Remark
	SSP	Y-copy	V-shape	XML	
1	X41			1401	Error Text: No permission. RBAC User role(s) are not sufficient. Validation: RBAC role name "APPLICBTE" is required Remark: checked by ICM / Receipt
2	X44			1404	Error Text: If "non repudiation of emission" is mandatory, the NRE indicator flag has to be present Validation: If non-repudiaton processing is mandatory, the tag <SwInt:NRIndicator>TRUE</SwInt:NRIndicator> has to be present. Remark: Receipt /checked by ICM

ModifyHAMAccount_SD_1

Scope: Modify a HAM account

Name Proprietary message	<PrtryMsg>
Message Header	<MsgHdr>
Message Identification	<MsgId>ABC123</MsgId>
End of Message Header	</MsgHdr>
Proprietary Data	<PrtryData>
Proprietary Data type	<Tp>ModifyHAMAccount</Tp>
Proprietary Data	<Data>
SSP Proprietary Data	<SspPrtryDt>
Message Type	<ModifyHAMAccount>
HAM Account	<HamAcct>
CB Responsible	<Ctry>ES</Ctry>
BIC	<BIC>ZYAJFRT0HS1</BIC>
Record Status all Modify and Delete messages	<RecSts>FU</RecSts>
Account Information	<AcctInf>
Update Flag	<UpdtFlag>N</UpdtFlag>
HAM Account Number	<HamAcctNb>ESZYAJFRT0HS1</HamAcctNb>
HAM Account Type	<HamAcctTp>SU</HamAcctTp>
Notification BIC	<NtfctnBIC>SU</NtfctnBIC>
Accept MT202 Notify	<Ntfctn202LqdyTrf>N</Ntfctn202LqdyTrf>
Accept MT900 Notify	<Ntfctn900>Y</Ntfctn900>
Accept MT910 Notify	<Ntfctn910>Y</Ntfctn910>
Balance Report	<BalRpt>940</BalRpt>
BIC Co Manager	<CmngrBIC>ESZYAJFRT0HCB</CmngrBIC>
Activation Date	<ActDt>2013-03-08</ActDt>
End of Account Information	</AcctInf>
End of HAM Account	</HamAcct>
End of Message Type	</ModifyHAMAccount>
End of SSP Proprietary Data	</SspPrtryDt>
End of Proprietary Data	</Data>
End of Proprietary Data	</PrtryData>
End proprietary message	</PrtryMsg>

6. 5.25 ModifyLimit

Cash Management Standard

ModifyLimit_SD

Scope: The ModifyLimit message sent to SD is used to define or modify

- one or several bilateral standing order limits
- the standing order multilateral limit
- all standing orders for bilateral limits (only modification of existing standing orders)

The modification becomes effective the next business day.

Bilateral limit against accounts without non-liability of cover is not allowed.
In addition limit for or against guarantee account is not possible.

The value 0,00 is possible for deletion of standing order limits.

When the last standing order for bilateral limit is deleted the standing order for multilateral limit is deleted automatically.
(There will be no task for an automatic deletion!)

The ModifyLimit message can be sent by the application of a direct PM participant or the application of a group of accounts manager "virtual account" (definition and change of limits possible for the whole group only, not for the single account holder).

If a participant is a member of an account group, the limit can only be defined against the whole group. Therefore limits that are defined against an account group have to be defined against the account owner (BIC) of the group of accounts manager.

The ModifyLimit message is replied by a Receipt message. The Receipt can contain multiple ReceiptDetails - one per affected standing order. Different to the procedure in case of other writing requests the RelatedReference returned for every task is not the SD task queue reference but the BIC of bilateral counterpart (has to be unique) or codeword MULT. The usage of GetTask sent to SD is not suitable (and not supported here because the task queue reference is replaced by counterpart BIC) because the final status of order processing is returned in the Receipt. OK means the order is processed successfully. In case of problems an error is returned.

In case a remarkable number of standing orders shall be modified by sending only one request it may happen that a time-out message is returned. Then the customer application needs to send a GetPendingData request to get the Receipt with the order results.

Non-Repudiation of Emission (NRE) is supported.

<camt.011.001.xx>

Structure:

LiquidityManagementDefaultLimit	<DfltLmt>
Message name for ModifyLimit	<ModfyLmt>
Message Header	<MsgHdr>
Message Identification	<MsgId></MsgId>
End of Message Header	</MsgHdr>
LimitDetails	<LmtDtls>
LimitIdentificationChoice	<LmtId>
Choice	xorDfltAIDflt
LimitIdentification	<Dflt>
BilateralLimitCounterpartyId	<BilLmtCtrPtyId>
Financial Institution Identification	<FinInstnId>
BICFIIdentifier	<BICFI></BICFI>
End of Financial Institution Identification	</FinInstnId>
End of BilateralLimitCounterpartyId	</BilLmtCtrPtyId>
Limit Type	<Tp>
Limit Type Code	<Cd></Cd>
End of Limit Type	</Tp>
Account Owner	<AcctOwnr>
Financial Institution Identification	<FinInstnId>
BICFIIdentifier	<BICFI></BICFI>
End of Financial Institution Identification	</FinInstnId>
End of Account owner	</AcctOwnr>

End of LimitIdentification	</Dflt>
LimitIdentification	<AIDflt>
Limit Type	<Tp>
Limit Type Code	<Cd></Cd>
End of Limit Type	</Tp>
Account Owner	<AcctOwnr>
Financial Institution Identification	<FinInstnId>
BICFIIdentifier	<BICFI></BICFI>
End of Financial Institution Identification	</FinInstnId>
End of Account owner	</AcctOwnr>
End of LimitIdentification	</AIDflt>
End of Choice	/xorDfltAIDflt
End of LimitIdentificationChoice	</LmtId>
NewLimitValueSet	<NewLmtValSet>
Amount	<Amt>
Amount without currency	<AmtWthtCcy></AmtWthtCcy>
End of Amount	</Amt>
End of NewLimitValueSet	</NewLmtValSet>
End Limit details structure	</LmtDtls>
End Message Type	</ModfyLmt>

Attributes:

name of attribute	format	short description	description
<DfltLmt>		LiquidityManagementDefaultLimit Optional	Validation:
<ModifyLmt>		Messagename for ModifyLimit Mandatory A2A	Messagename for ModifyLimit Validation:
<MsgHdr>		Message Header Mandatory A2A	Set of characteristics specific to the message Validation: [1..1]
<MsgId>-</MsgId>	35x	Message Identification Mandatory A2A	Message Identification Validation: [1..1]
</MsgHdr>		End of Message Header Mandatory A2A	Validation: [1..1]
<LmtDtls>		LimitDetails Mandatory A2A	Identification of the details of one particular limit. Validation: [1..n] differs from the cash management standard. Only <DfltLmtId> or <AllDfltLmts> is allowed.
<LmtId>		LimitIdentificationChoice Mandatory	Validation: [1..1]
xorDfltAllDflt		Choice Mandatory	Choice amongst <Dflt> and <AllDflt> Validation:
<Dflt>		LimitIdentification Mandatory A2A	Validation: [1..1]
<BilLmtCtrPtyId>		BilateralLimitCounterpartyId Optional A2A	Unique and unambiguous identification of a member within a system, assigned using the member identification scheme of the system. Validation: [0..1] Counterpart is filled in the case of an asked Bilateral Limit, Counterpart definition is possible for Liquidity Limits
<FinInstnId>		Financial Institution Identification Mandatory	Financial Institution Identification Validation: [1..1]
<BICFI>-</BICFI>	4!a2!a2!c3!c	BICFIIdentifier Mandatory A2A	BICFIIdentifier Validation: [1..1] The BIC has to be valid and must indicate a RTGS account in SSP. The BIC mustn't match with the account owner.

name of attribute	format	short description	description
			<p>It has to be unique in the request.</p> <p>In case the counterpart is part of a virtual account the BIC of the group of accounts manager has to be used instead.</p> <p>A bilateral limit against accounts without non-liability of cover is not allowed.</p> <p>The type of counterpart account must be "normal".</p>
</FinInstnId>		<p>End of Financial Institution Identification</p> <p>Mandatory</p>	<p>End of Financial Institution Identification</p> <p>Validation: [1..1]</p>
</BilLmtCtrPtyId>		<p>End of BilateralLimitCounterpartyId</p> <p>Optional</p> <p>A2A</p>	<p>End ofBilateralLimitCounterpartyIdentification</p> <p>Validation: [0..1]</p>
<Tp>		<p>Limit Type</p> <p>Mandatory</p>	<p>Limit Type</p> <p>Validation: [1..1]</p>
<Cd>-</Cd>		<p>Limit Type Code</p> <p>Mandatory</p> <p>A2A</p>	<p>Limit Type Code</p> <p>SSP restricted code list:</p> <p>BILI = Bilateral Limit is applied by one party to a specific counterparty, and corresponds to the maximum amount of traffic party setting the limit can send to that counterparty. The limit can be expressed as a debit or a credit limit. With the help of a bilateral limit, the direct participant restricts the use of liquidity when clearing payments with another direct participant.</p> <p>MULT = Multilateral Limit is a maximum amount value applied to, or by, a participant to a set of counterparties. The multilateral limit is taken into account by the transaction administrator to contain the risk in the system. With the help of the multilateral limit, the direct participant restricts the use of liquidity when clearing payments with all other direct participants for which no bilateral limit is set</p> <p>for Limits Defined Limit (Standing Order)</p> <p>Validation: [1..1] only BILI and MULT can be used in SSP. MULT mustn't be used more than once per request.</p>
</Tp>		<p>End of Limit Type</p> <p>Mandatory</p>	<p>End of Limit Type</p> <p>Validation: [1..1]</p>
<AcctOwNr>		<p>Account Owner</p> <p>Optional</p> <p>A2A</p>	<p>BIC of the RTGS main account/ in case of group of accounts BIC of the GoA manager</p> <p>Validation: [0..1] In case of "on behalf" scenario (sending party not Account Owner) mandatory. When not stated the BIC of the participant is used. Sender has to be authorized to work on behalf of the stated AccountOwner. - CB may only fill in BICs of participants she is responsible for; GoA manager may only use their own BICs. Only one occurrence of an element <AcctOwNr> is allowed.</p>
<FinInstnId>		<p>Financial Institution Identification</p>	<p>Financial Institution Identification</p>

name of attribute	format	short description	description
		Mandatory	Validation: [1..1]
<BICFI>-</BICFI>	4!a2!a2!c3!c	BICFIIdentifier	BICFIIdentifier
		Mandatory	Validation: [1..1]
</FinInstnId>		End of Financial Institution Identification	End of Financial Institution Identification
		Mandatory	Validation: [1..1]
</AcctOwnr>		End of Account owner	
		Optional	Validation: [0..1]
</Dflt>		End of LimitIdentification	
		Mandatory	Validation: [1..1]
		A2A	
<AlIDflt>		LimitIdentification	Be aware using this element is only for modification or deletion of existing standing orders.
		Mandatory	Validation: [1..1]
		A2A	
<Tp>		Limit Type	Limit Type
		Optional	Validation:
<Cd>-</Cd>		Limit Type Code	Limit Type Code
			SSP restricted code list:
			BILI = Bilateral Limit is applied by one party to a specific counterparty, and corresponds to the maximum amount of traffic party setting the limit can send to that counterparty. The limit can be expressed as a debit or a credit limit. With the help of a bilateral limit, the direct participant restricts the use of liquidity when clearing payments with another direct participant.
			MULT = Multilateral Limit is a maximum amount value applied to, or by, a participant to a set of counterparties. The multilateral limit is taken into account by the transaction administrator to contain the risk in the system. With the help of the multilateral limit, the direct participant restricts the use of liquidity when clearing payments with all other direct participants for which no bilateral limit is set
			If <Tp> is filled with BILI then for every bilateral counterpart a separate task is generated and a list of all counterpart BICs is provided in the Receipt (in RltdRef/Ref).
		Mandatory	Validation:
		A2A	[1..1] In SSP only BILI and MULT are allowed. MULT mustn't be used more than once per request.
</Tp>		End of Limit Type	End of Limit Type
		Optional	Validation:
<AcctOwnr>		Account Owner	

name of attribute	format	short description	description
		Optional	Validation: [0..1]
<FinInstnId>		Financial Institution Identification Mandatory	Financial Institution Identification Validation: [1..1]
<BICFI>-</BICFI>	4!a2!a2!c3!c	BICFIIdentifier Optional A2A	BICFIIdentifier BIC of the RTGS main account/ in case of group of accounts BIC of the GoA manager Validation: [0..1] In case of "on behalf" scenario (sending party not Account Owner) mandatory. When not stated the BIC of the participant is used. Sender has to be authorized to work on behalf of the stated AccountOwner. - CB may only fill in BICs of participants she is responsible for; GoA manager may only use their own BICs. Only one occurrence of an element <AcctOwnr> is allowed.
</FinInstnId>		End of Financial Institution Identification Mandatory	End of Financial Institution Identification Validation: [1..1]
</AcctOwnr>		End of Account owner Optional	Validation: [0..1]
</AIIDflt>		End of LimitIdentification Mandatory A2A	Validation: [1..1]
/xorDfltAIIDflt		End of Choice Mandatory	End of Choice amongst <Dflt> and <AIIDflt> Validation:
</LmtId>		End of LimitIdentificationChoice Mandatory	Validation: [1..1]
<NewLmtValSet>		NewLimitValueSet Mandatory A2A	New limit values. Maximum value used for risk containment in a system or towards counterparts. The limit may be a current limit or a default limit. Validation: [1..1]
<Amt>		Amount Mandatory A2A	Validation: [1..1]
<AmtWthtCcy>-</AmtWthtCcy>	18n	Amount without currency	Number of monetary units specified in a currency where the unit of currency is implied by the context. totalDigits = 18 fractionDigits = 5 New multilateral Limit Standing Order or new bilateral Limit Standing Order

name of attribute	format	short description	description
		Mandatory A2A	Validation: [1..1] Only 2 fraction digits are possible. Value restriction: maximum value 999.999.999.999,99. Limit value must be 1 million or more. The value 0,00 is possible for deletion of limits.
</Amt>		End of Amount Mandatory A2A	Validation: [1..1]
</NewLmtValSet>		End of NewLimitValueSet Mandatory A2A	End of NewLimitValueSet Validation: [1..1]
</LmtDtls>		End Limit details structure Mandatory A2A	Validation: [1..n]
</ModifyLmt>		End Message Type Mandatory A2A	Validation:

Error Codes:

Order	Error code				Error Text / Validation/ Remark
	SSP	Y-copy	V-shape	XML	
1	X00			0000	Error Text: O.k. Validation: Confirmation, that a task is stored in the task queue. A related reference for the subsequent processing (e.g. confirmation) of the task is returned. Remark: Receipt (status code)
2	X41			1401	Error Text: No permission. RBAC User role(s) are not sufficient. Validation: RBAC role name "APPLICATE" or "APPLICBTE" are required Remark: checked by ICM / Receipt
3	X44			1404	Error Text: If "non repudiation of emission" is mandatory, the NRE indicator flag has to be present Validation: If non-repudiaton processing is mandatory, the tag <SwInt:NRIndicator>TRUE</SwInt:NRIndicator> has to be present. Remark: checked by ICM / Receipt
4	X42			1402	Error Text: No authorisation. User is not allowed acting on behalf of another participant. Validation: DfltLmtld/AcctOwnr (profile credit institution) value must indicate the credit institution itself or a participant who the credit institution is entitled to act on behalf of Remark: checked by ICM / Receipt
5	X45			1405	Error Text: No authorisation or rather interaction not possible. User is not allowed acting on behalf of another participant as Group of Account manager Validation: DfltLmtld/AcctOwnr (profile group of accounts manager) value must indicate the group of accounts manager of Remark: checked by ICM / Receipt
6	X47			1407	Error Text: No authorisation. User is not allowed acting on behalf of another Participant as Central Bank Validation: DfltLmtld/AcctOwnr (profile central bank) value must indicate the central bank itself or a participant the central bank is responsible for Remark: checked by ICM / Receipt
7	P12			P012	Error Text: Modification, setting or deletion of limits not possible Validation: BilLmtCtrPtyld/BIC value must not indicate the participant itself (self-addressed bilateral limit is not allowed) Remark: checked by ICM / Receipt
8	P53			P053	Error Text: RTGS account does not exist or is not valid Validation: DfltLmtld/AcctOwnr value must indicate a SSP participant, BIC of the RTGS account which will be modified, has to be valid Remark: checked by ICM / Receipt
9	P51			P051	Error Text: BIC Bilateral Counterpart does not exist Validation: BilLmtCtrPtyld/BIC value must indicate a SSP participant Remark: checked by ICM / Receipt
16	P30			P030	Error Text: Only one occurrence of the element <AcctOwnr> per message is allowed. Validation: If element <AcctOwnr> is used it may only occur once. Remark: checked by ICM / Receipt
17	P31			P031	Error Text: The modification or removal of a multilateral limit is allowed only

Order	Error code				Error Text / Validation/ Remark
	SSP	Y-copy	V-shape	XML	
					once per message. Validation: The modification or removal of a multilateral limit may be requested only once per request. If type "MULT" occurs more than once an error message will be returned. Remark: checked by ICM / Receipt
18	P32			P032	Error Text: The same counterpart-BIC is only allowed not more than once per message. Validation: Any bilateral counterpart can only occur once in a message. Remark: checked by ICM / Receipt
19	P33			P033	Error Text: Invalid use of <AllCurLmts> or <AIDfltLmts>. Validation: If <AIDfltLmts> is used in a request, <LmtDtIs> should occur at most twice. - Repetition only allowed if different limit types ("BILI" + "MULT") are filled in. Remark: checked by ICM / Receipt
20	P33			P033	Error Text: Invalid use of <AllCurLmts> or <AIDfltLmts>. Validation: It is not allowed to set a new value unequal to zero for multilateral limit if the modification of all bilateral limits to zero is requested in the same message. Remark: checked by ICM / Receipt
21	P33			P033	Error Text: Invalid use of <AllCurLmts> or <AIDfltLmts>. Validation: Modification of single limits in combination with 'All' is forbidden. (<DfltLmtId> and <AIDfltLmts> should never be found together in one request) Remark: checked by ICM / Receipt
22	960			S600	Error Text: The requested creation is not possible Validation: For a participant with participation type CI having a guarantee account the definition of limits is not allowed (it is only allowed for account type "normal"). Remark: Additional SD error message: "The type of account must be normal."
23	960			S600	Error Text: The requested creation is not possible Validation: The definition of bilateral limits is only allowed against counterparties with account type "normal". Remark: Additional SD error message: "The type of account must be normal."
24	P52			P052	Error Text: BIC Bilateral Counterpart must not indicate a member of a Virtual Account. Validation: BilLmtCtrPtyId/BIC value must not indicate a member of a GoA Virtual Account. Instead it has to be used the BIC of the GoA manager to define the bilateral limit against the whole group. Remark: checked by ICM / Receipt

ModifyLimit_SD_1

Scope: Modify Limit, modification of a multilateral default /standing order limit (Sending party and Account Owner are identic)

MessageName for ModifyLimit	<ModifyLmt>
Message Header	<MsgHdr>
Message Identification	<MsgId>ABCDEFGHIJKLMNOPQRSTUVWXYZabcdefghi</MsgId>
End of Message Header	</MsgHdr>
LimitDetails	<LmtDtls>
LimitIdentificationChoice	<LmtId>
LimitIdentification	<Dflt>
Limit Type	<Tp>
Limit Type Code	<Cd>MULT</Cd>
End of Limit Type	</Tp>
End of LimitIdentification	</Dflt>
End of LimitIdentificationChoice	</LmtId>
NewLimitValueSet	<NewLmtValSet>
Amount	<Amt>
Amount without currency	<AmtWthtCcy>80000000.00</AmtWthtCcy>
End of Amount	</Amt>
End of NewLimitValueSet	</NewLmtValSet>
End Limit details structure	</LmtDtls>
End Message Type	</ModifyLmt>

ModifyLimit_SD_2

Scope: Modify Limit: change bilateral standing order limit against counterpart, on behalf of third party (Sending party and Account Owner are different)

MessageName for ModifyLimit	<ModfyLmt>
Message Header	<MsgHdr>
Message Identification	<MsgId>ABC123456</MsgId>
End of Message Header	</MsgHdr>
LimitDetails	<LmtDtls>
LimitIdentificationChoice	<LmtId>
LimitIdentification	<Dflt>
BilateralLimitCounterpartyId	<BilLmtCtrPtyId>
Financial Institution Identification	<FinInstnId>
BICFIIdentifier	<BICFI>DRESDEFFXXX</BICFI>
End of Financial Institution Identification	</FinInstnId>
End of BilateralLimitCounterpartyId	</BilLmtCtrPtyId>
Limit Type	<Tp>
Limit Type Code	<Cd>BILI</Cd>
End of Limit Type	</Tp>
Account Owner	<AcctOwnr>
Financial Institution Identification	<FinInstnId>
BICFIIdentifier	<BICFI>DEUTDEFFXXX</BICFI>
End of Financial Institution Identification	</FinInstnId>
End of Account owner	</AcctOwnr>
End of LimitIdentification	</Dflt>
End of LimitIdentificationChoice	</LmtId>
NewLimitValueSet	<NewLmtValSet>
Amount	<Amt>
Amount without currency	<AmtWthtCcy>6600000.00</AmtWthtCcy>
End of Amount	</Amt>
End of NewLimitValueSet	</NewLmtValSet>
End Limit details structure	</LmtDtls>
End Message Type	</ModfyLmt>

ModifyLimit_SD_3

Scope: Setting the multilateral standing order limit to one value (Sending party and Account Owner are different)

MessageName for ModifyLimit	<ModfyLmt>
Message Header	<MsgHdr>
Message Identification	<Msgld>ABC123456</Msgld>
End of Message Header	</MsgHdr>
LimitDetails	<LmtDtls>
LimitIdentificationChoice	<Lmtld>
LimitIdentification	<Dflt>
Limit Type	<Tp>
Limit Type Code	<Cd>MULT</Cd>
End of Limit Type	</Tp>
Account Owner	<AcctOwnr>
Financial Institution Identification	<FinInstnld>
BICFIIdentifier	<BICFI>DRESDEFF</BICFI>
End of Financial Institution Identification	</FinInstnld>
End of Account owner	</AcctOwnr>
End of LimitIdentification	</Dflt>
End of LimitIdentificationChoice	</Lmtld>
NewLimitValueSet	<NewLmtValSet>
Amount	<Amt>
Amount without currency	<AmtWthtCcy>1000000</AmtWthtCcy>
End of Amount	</Amt>
End of NewLimitValueSet	</NewLmtValSet>
End Limit details structure	</LmtDtls>
End Message Type	</ModfyLmt>

6. 5.26 ModifyReservation

Cash Management Standard

ModifyReservation_SD

Scope: The ModifyReservation message is used to

- define a standing order reservation (highly urgent or urgent) which becomes effective from the next business day
- modify the standing order reservation (highly urgent or urgent) which become effective from the next business day

The ModifyReservation message can be sent by the application of a direct PM participant or the application of a group of accounts manager ("virtual account" reservation of liquidity possible for the whole group only, not for the single account holder).

If a participant is a member of an account group, the limit can only be defined against the whole group. Therefore limits that are defined against an account group have to be defined against the account owner (BIC) of the leading account of the group.

The ModifyReservation message is replied by a Receipt message. Non-Repudiation of Emission (NRE) is supported.

<camt.048.001.xx>

Structure:

Messsge name for ModifyReservation	<ModfyRsvatn>
Message Header	<MsgHdr>
Message Identification	<MsgId></MsgId>
End of Message Header	</MsgHdr>
CurrentOrDefaultReservation	<RsvatnId>
ReservationIdentification	<Dflt>
ReservationType	<Tp>
ReservationTypeCode	<Cd></Cd>
End of ReservationType	</Tp>
Account Owner	<AcctOwnr>
Financial Institution Identification	<FinInstnId>
BICFIIdentifier	<BICFI></BICFI>
End of Financial Institution Identification	</FinInstnId>
End of Account owner	</AcctOwnr>
End of ReservationIdentification	</Dflt>
End of CurrentOrDefaultReservation	</RsvatnId>
NewReservationValueSet	<NewRsvatnValSet>
Amount	<Amt>
Amount without currency	<AmtWthtCcy></AmtWthtCcy>
End of Amount	</Amt>
End of NewReservationValueSet	</NewRsvatnValSet>
End of messsge name for ModifyReservation	</ModfyRsvatn>

Attributes:

name of attribute	format	short description	description
<ModifyRsvatn>		Messsge name for ModifyReservation Mandatory A2A	Messsge name for ModifyReservation Validation:
<MsgHdr>		Message Header Mandatory A2A	Set of characteristics specific to the message Validation: [1..1]
<MsgId>-</MsgId>	35x	Message Identification Mandatory A2A	Message Identification Validation: [1..1]
</MsgHdr>		End of Message Header Mandatory A2A	Validation: [1..1]
<RsvatnId>		CurrentOrDefaultReservatio n Mandatory	CurrentOrDefaultReservation Validation: [1..1]
<Dflt>		ReservationIdentification Mandatory A2A	Validation: [1..1]
<Tp>		ReservationType Optional	ReservationType Validation:
<Cd>-</Cd>		ReservationTypeCode Mandatory A2A	ReservationTypeCode SSP restricted code list: UPAR = UrgentPaymentReservation Amount set aside by a participant to reserve liquidity from its own account, exclusively for executing urgent payments. HPAR = HighlyUrgentPayment reservation Amount set aside by a participant to reserve liquidity from its own account, exclusively for executing highly urgent payment Validation: [1..1] in PM only HPAR and UPAR are used
</Tp>		End of ReservationType Optional	End of ReservationType Validation:
<AcctOwnr>		Account Owner Optional	Validation: [0..1]
<FinInstnId>		Financial Institution Identification Mandatory	Financial Institution Identification Validation: [1..1]

name of attribute	format	short description	description
<BICFI>-</BICFI>	4!a2!a2!c3!c	BICFIIdentifier	BICFIIdentifier in case of group of accounts BIC of the leading account of the group Validation: [0..1] mandatory when BIC RTGS main account is used on behalf of third parties, when not stated the BIC of the participant is used
</FinInstnId>		End of Financial Institution Identification Mandatory	End of Financial Institution Identification Validation: [1..1]
</AcctOwnr>		End of Account owner Optional	Validation: [0..1]
</Dflt>		End of ReservationIdentification Mandatory A2A	Validation: [1..1]
</RsvatnId>		End of CurrentOrDefaultReservation Optional	End of CurrentOrDefaultReservation Validation:
<NewRsvatnValSet>		NewReservationValueSet Mandatory A2A	NewReservationValueSet Validation: [1..1] new total amount for the reservation
<Amt>		Amount Mandatory A2A	Validation: [1..1]
<AmtWthtCcy>-</AmtWthtCcy>	18n	Amount without currency	Number of monetary units specified in a currency where the unit of currency is implied by the context. totalDigits = 18 fractionDigits = 5 Amount in EUR Validation: [1..1] in PM only 2 fraction digits are possible value restriction: maximum value 999.999.999.999,99
</Amt>		End of Amount Mandatory A2A	Validation: [1..1]
</NewRsvatnValSet>		End of NewReservationValueSet Mandatory A2A	End of NewReservationValueSet Validation: [1..1]
</ModfyRsvatn>		End of messsge name for ModifyReservation Mandatory A2A	End of messsge name for ModifyReservation Validation:

Error Codes:

Order	Error code				Error Text / Validation/ Remark
	SSP	Y-copy	V-shape	XML	
1	X00			0000	Error Text: O.k. Validation: Confirmation, that a task is stored in the task queue. A related reference for the subsequent processing (e.g. confirmation) of the task is returned. Remark: Receipt (status code)
2	X41			1401	Error Text: No permission. RBAC User role(s) are not sufficient. Validation: RBAC role name "APPLICATE" or "APPLICBTE" are required Remark: checked by ICM / Receipt
3	X44			1404	Error Text: If "non repudiation of emission" is mandatory, the NRE indicator flag has to be present Validation: If non-repudiaton processing is mandatory, the tag <SwInt:NRIndicator>TRUE</SwInt:NRIndicator> has to be present. Remark: checked by ICM / Receipt
4	X42			1402	Error Text: No authorisation. User is not allowed acting on behalf of another participant. Validation: DfltRsvatnId/AcctOwnr (profile credit institution) value must indicate the credit institution itself or a participant who the credit institution is entitled to act on behalf of Remark: checked by ICM / Receipt
5	X45			1405	Error Text: No authorisation or rather interaction not possible. User is not allowed acting on behalf of another participant as Group of Account manager Validation: DfltRsvatnId/AcctOwnr (profile group of accounts manager) value must indicate the group of accounts manager Remark: checked by ICM / Receipt
6	X47			1407	Error Text: No authorisation. User is not allowed acting on behalf of another Participant as Central Bank Validation: DfltRsvatnId/AcctOwnr (profile central bank) value must indicate the central bank itself or a participant the central bank is responsible for Remark: checked by ICM / Receipt
7	P53			P053	Error Text: RTGS account does not exist or is not valid Validation: DfltLmtId/AcctOwnr value must indicate a SSP participant (BIC of the RTGS account which will be modified, has to be valid) Remark: checked by ICM / Receipt

ModifyReservation_SD_1

Scope: Modify standing order reservation for urgent payments. Behalf of scenario, Sending party and BIC SSP-Participant (AccountOwner) are different.

Messsge name for ModifyReservation	<ModfyRsvatn>
Message Header	<MsgHdr>
Message Identification	<MsgId>ABC123</MsgId>
End of Message Header	</MsgHdr>
CurrentOrDefaultReservation	<RsvatnId>
ReservationIdentification	<Dflt>
ReservationType	<Tp>
ReservationTypeCode	<Cd>UPAR</Cd>
End of ReservationType	</Tp>
Account Owner	<AcctOwnr>
Financial Institution Identification	<FinInstnId>
BICFIIdentifier	<BICFI>DEUTDEFFXXX</BICFI>
End of Financial Institution Identification	</FinInstnId>
End of Account owner	</AcctOwnr>
End of ReservationIdentification	</Dflt>
End of CurrentOrDefaultReservation	</RsvatnId>
NewReservationValueSet	<NewRsvatnValSet>
Amount	<Amt>
Amount without currency	<AmtWthtCcy>50000000.00</AmtWthtCcy>
End of Amount	</Amt>
End of NewReservationValueSet	</NewRsvatnValSet>
End of messsge name for ModifyReservation	</ModfyRsvatn>

ModifyReservation_SD_2

Scope: Modify standing order reservation for highly urgent payments. Sending party and BIC SSP-Participant are identic.

Messsge name for ModifyReservation	</ModfyRsvatn>
Message Header	<MsgHdr>
Message Identification	<MsgId>ABC123</MsgId>
End of Message Header	</MsgHdr>
CurrentOrDefaultReservation	<RsvatnId>
ReservationIdentification	<Dflt>
ReservationType	<Tp>
ReservationTypeCode	<Cd>HPAR</Cd>
End of ReservationType	</Tp>
End of ReservationIdentification	</Dflt>
End of CurrentOrDefaultReservation	</RsvatnId>
NewReservationValueSet	<NewRsvatnValSet>
Amount	<Amt>
Amount without currency	<AmtWthtCcy>50000000.00</AmtWthtCcy>
End of Amount	</Amt>
End of NewReservationValueSet	</NewRsvatnValSet>
End of messsge name for ModifyReservation	</ModfyRsvatn>

6. 5.27 ModifyRTGSAccount (for CBs only)

SSP Proprietary Messages

ModifyRTGSAccount_SD

Scope: Aim :
It is used to create or modify RTGS account.

Precondition :

- The user is logged in and is allowed, thanks to his pre-defined role, to use this transaction.
- The requestor must know precisely the BIC11 identifying the related participant, owner of the RTGS account and the responsible Central Bank.
- Data used by requestor to enter or modify information on RTGS Account may be:
 - RTGS account Number
 - Accept advice (flag Y/N)
 - Balance Report (flag Y/N)
 - Credit Based Only (flag Y/N)
 - Information on Liquidity Removal
 - Maximum amount per day for direct debit
 - Information on Group of Accounts Assignment
 - Activation date of the update

XML Request :
Modify RTGS Account

XML Response :
Receipt

<camt.998.001.xx>

Structure:

Name Proprietary message	<PrtryMsg>
Message Header	<MsgHdr>
Message Identification	<MsgId></MsgId>
End of Message Header	</MsgHdr>
Proprietary Data	<PrtryData>
Proprietary Data type	<Tp>ModifyRTGSAccount</Tp>
Proprietary Data	<Data>
SSP Proprietary Data	<SspPrtryDt>
Message Type	<ModifyRTGSAccount>
RTGS Account	<RTGSAcct>
CB Responsible	<Ctry></Ctry>
BIC	<BIC></BIC>
Record Status all Modify and Delete messages	<RecSts></RecSts>
Account Information	<AcctInf>
Update Flag	<UpdtFlag></UpdtFlag>
RTGS Account Number	<RTGSAcctNb></RTGSAcctNb>
RTGS Account Type	<RTGSAcctTp></RTGSAcctTp>
Accept MT900/910	<AcctAdv></AcctAdv>
Balance Report	<BalRpt></BalRpt>
Credit Based Only	<CdtsBsd></CdtsBsd>
Maximum Amount per day	<MaxAmtDay></MaxAmtDay>
Receiver BIC for Liq Removal Daylight	<BICLqdyRmvlDayLght></BICLqdyRmvlDayLght>
Account for Liq Removal Daylight	<AcctLqdyRmvlDayLght></AcctLqdyRmvlDayLght>
Receiver BIC for Liq Removal EoD	<BICLqdyRmvlEoD></BICLqdyRmvlEoD>
Account for Liq Removal EoD	<AcctLqdyRmvlEoD></AcctLqdyRmvlEoD>
Virtual Account	<VrtlAcct>
Group of Accounts ID	<GOAId></GOAId>
End of Virtual Account	</VrtlAcct>
Consolidated Information	<CnsltdInf>

Group of Accounts ID							<GOAId></GOAId>
End of Consolidated Information							</CnsltdInf>
Banking Group Monitoring							<BGM>
Group of Accounts ID							<GOAId></GOAId>
End of Banking Group Monitoring							</BGM>
Activation Date							<ActDt></ActDt>
Contingency Account Number							<CtgncyAcctNb></CtgncyAcctNb>
End of Account Information							</AcctInf>
End of RTGS Account							</RTGSAcct>
End of Message Type							</ModifyRTGSAccount>
End of SSP Proprietary Data							</SspPrtryDt>
End of Proprietary Data							</Data>
End of Proprietary Data							</PrtryData>
End proprietary message							</PrtryMsg>

Attributes:

name of attribute	format	short description	description
<PrtryMsg>		Name Proprietary message Mandatory	Validation:
<MsgHdr>		Message Header Mandatory	Set of characteristics specific to the message Validation: [1..1]
<MsgId>-</MsgId>	35x	Message Identification Mandatory	Message Identification Validation: [1..1]
</MsgHdr>		End of Message Header Mandatory	Validation: [1..1]
<PrtryData>		Proprietary Data Mandatory	Proprietary Data Validation: [1..1]
<Tp>-</Tp>	35x	Proprietary Data type Mandatory	Proprietary Data type defines the Type of the free format XML Validation: [1..1]
<Data>		Proprietary Data Mandatory	Proprietary data content Validation: [1..1]
<SspPrtryDt>		SSP Proprietary Data Mandatory	Root element for all SSP proprietary data Validation: [1..1]
<ModifyRTGSAccount>		Message Type Mandatory	Message Type for Static Data Validation: [1..1]
<RTGSAcct>		RTGS Account Mandatory	RTGS Account Validation: [1..1]
<Ctry>-</Ctry>	2!c	CB Responsible Mandatory	Country Code of the Responsible CB. Validation: [1..1]
<BIC>-</BIC>	4!a2!a2!c3!c	BIC Mandatory	A code allocated to a financial institution by a Registration Authority under an international identification scheme, as described in the latest edition of the international standard ISO 9362 "Banking - Banking telecommunication messages - Bank identifier codes". BIC 11 of the RTGS Account Holder (BIC Participant). Validation: [1..1]

name of attribute	format	short description	description
<RecSts>-</RecSts>	2x	Record Status all Modify and Delete messages	Status of the record. List of values : "AC" for Active "FU" for Future "IC" for In Change For more information on status management, please read the ICM UserHandBook. Optional Validation: [0..1] If Update Flag is equal to N then the <RecSts> is optional. If Update Flag is equal to U then the <RecSts> is mandatory.
<AcctInf>		Account Information Mandatory	Account Information Validation: [1..1]
<UpdtFlag>-</UpdtFlag>	1!a	Update Flag Mandatory	Flag used in "Modify" XML Message to indicate the type of update : "N" for new entry "U" for update of an existing entry Validation: [1..1]
<RTGSAcctNb>-</RTGSAcctNb>	2!c32x	RTGS Account Number Mandatory	Account Number. Length 34 characters. First two characters represent the country code of the responsible CB. Validation: [1..1]
<RTGSAcctTp>-</RTGSAcctTp>	3x	RTGS Account Type Mandatory	Indicates the type of RTGS Account. Values may be : "CI" for Credit Institution Account "CB" for Central Bank Account "LB" for CB Customer Liquidity Bridge Account (technical) "SFI" for Standing Facilities Interests Account (for CB only) "RIP" for RM interests and penalty Account (for CB only) "T2F" for Target 2 Fees Account (for CB only) "EC" for ECB Account (Technical) "ECM" for ECB Mirror Account (Technical) "IL" for SSP Interlinking Account (Technical) "ASM" for Ancillary System Technical account - procedure 6 real-time "AST" for Ancillary System Technical Account (Technical) "ASG" for Ancillary System Guarantee Account "CM" for Contingency Module Account (Technical) "T2S" for T2S Transit Account (Technical) Validation: [1..1]
<AccptAdvc>-</AccptAdvc>	1!a	Accept MT900/910 Mandatory	For RTGS Account : A flag with two values : 'Y' or 'N'. 'Y' means that the account holder will receive an advice (MT900 or MT910) for each debit/credit of the related RTGS Account. 'N' means that the account holder refuses to receive notification of debit/credit. Validation: [1..1]

name of attribute	format	short description	description
<BalRpt>-</BalRpt>	3!n	Balance Report	This is the Swift message type for Balance Report. List of values : "940", "950" or "none"
		Mandatory	Validation: [1..1]
<CdtsBsd>-</CdtsBsd>	1!a	Credit Based Only	A flag with two values : 'Y' or 'N'. Used to indicate whether the related RTGS Account may have an uncovered negative balance (value is 'N') or not (value is 'Y').
		Mandatory	Validation: [1..1]
<MaxAmtDay>-	18!d	Maximum Amount per day	Maximum Amount per day in case of Direct Debit. Amount, made of a maximum of 17 numbers and one digit (decimal coma)
		Optional	Validation: [0..1]
<BICLqdyRmvlDaylght>-</BICLqdyRmvlDaylght>	4!a2!a2!c[3!c]	Receiver BIC for Liq Removal Daylight	A code allocated to a financial institution by a Registration Authority under an international identification scheme, as described in the latest edition of the international standard ISO 9362 "Banking - Banking telecommunication messages - Bank identifier codes". In this case, this is the BIC 11 used for the liquidity removal during the day.
		Optional	Validation: [0..1]
<AcctLqdyRmvlDaylight>-</AcctLqdyRmvlDaylight>	34x	Account for Liq Removal Daylight	Account Code. Lenght 34 characters
		Optional	Validation: [0..1]
<BICLqdyRmvlEoD>-</BICLqdyRmvlEoD>	4!a2!a2!c[3!c]	Receiver BIC for Liq Removal EoD	A code allocated to a financial institution by a Registration Authority under an international identification scheme, as described in the latest edition of the international standard ISO 9362 "Banking - Banking telecommunication messages - Bank identifier codes". In this case, this is the BIC 11 for liquidity removal at the end of day.
		Optional	Validation: [0..1]
<AcctLqdyRmvlEoD>-</AcctLqdyRmvlEoD>	34x	Account for Liq Removal EoD	Account Code. Lenght 34 characters
		Optional	Validation: [0..1]
<VrtlAcct>		Virtual Account	Virtual Account
		Optional	Validation: [0..1]
<GOAId>-</GOAId>	12x	Group of Accounts ID	Group of Accounts ID. Lenght 12 characters.
		Mandatory	Validation: [1..1]
</VrtlAcct>		End of Virtual Account	End of Virtual Account
		Optional	Validation:

name of attribute	format	short description	description
			[0..1]
<CnsltdInf>		Consolidated Information Optional	Consolidated Information Group of Account Validation: [0..1]
<GOAId>-</GOAId>	12x	Group of Accounts ID Mandatory	Group of Accounts ID. Lenght 12 characters. Validation: [1..1]
</CnsltdInf>		End of Consolidated Information Optional	End of Consolidated Information Validation: [0..1]
<BGM>		Banking Group Monitoring Optional	Banking Group Monitoring Validation: [0..1]
<GOAId>-</GOAId>	12x	Group of Accounts ID Optional	Group of Accounts ID. Lenght 12 characters. Validation: [1..1]
</BGM>		End of Banking Group Monitoring Optional	End of Banking Group Monitoring Validation: [0..1]
<ActDt>-</ActDt>	ISODate	Activation Date Mandatory	Date within a particular calendar year represented by YYYY-MM-DD (ISO 8601). Validation: [1..1]
<CtgnCyAcctNb>-</CtgnCyAcctNb>	2!c32x	Contingency Account Number Mandatory	Account Code. Lenght 34 characters Validation: [1..1]
</AcctInf>		End of Account Information Mandatory	End of Account Information Validation: [1..1]
</RTGSAcct>		End of RTGS Account Mandatory	End of RTGS Account Validation: [1..1]
</ModifyRTGSAccount>		End of Message Type Mandatory	End of Message Type for Static Data Validation: [1..1]
</SspPrtryDt>		End of SSP Proprietary Data Mandatory	End of Root element for all SSP proprietary data Validation: [1..1]
</Data>		End of Proprietary Data Mandatory	Validation: [1..1]

name of attribute	format	short description	description
</PrtryData>		End of Proprietary Data	End of Proprietary Data
		Mandatory	Validation: [1..1]
</PrtryMsg>		End proprietary message	
		Mandatory	Validation:

Error Codes:

Order	Error code				Error Text / Validation/ Remark
	SSP	Y-copy	V-shape	XML	
1	X41			1401	Error Text: No permission. RBAC User role(s) are not sufficient. Validation: RBAC role name "APPLICBTE" is required Remark: checked by ICM / Receipt
2	X44			1404	Error Text: If "non repudiation of emission" is mandatory, the NRE indicator flag has to be present Validation: If non-repudiaton processing is mandatory, the tag <SwInt:NRIndicator>TRUE</SwInt:NRIndicator> has to be present. Remark: Receipt /checked by ICM

ModifyRTGSAccount_SD_1

Scope: Modify a RTGS account

Name Proprietary message	<PrtryMsg>
Message Header	<MsgHdr>
Message Identification	<MsgId>ABC123</MsgId>
End of Message Header	</MsgHdr>
Proprietary Data	<PrtryData>
Proprietary Data type	<Tp>ModifyRTGSAccount</Tp>
Proprietary Data	<Data>
SSP Proprietary Data	<SspPrtryDt>
Message Type	<ModifyRTGSAccount>
RTGS Account	<RTGSAcct>
CB Responsible	<Ctry>FR</Ctry>
BIC	<BIC>ZYAJFRT0FS1</BIC>
Record Status all Modify and Delete messages	<RecSts>FU</RecSts>
Account Information	<AcctInf>
Update Flag	<UpdtFlag>N</UpdtFlag>
RTGS Account Number	<RTGSAcctNb>FRRTGS0000000001</RTGSAcctNb>
RTGS Account Type	<RTGSAcctTp>Y</RTGSAcctTp>
Accept MT900/910	<AcceptAdvc></AcceptAdvc>
Balance Report	<BalRpt>950</BalRpt>
Credit Based Only	<CdtsBsd>Y</CdtsBsd>
Maximum Amount per day	<MaxAmtDay>1000000000.00</MaxAmtDay>
Virtual Account	<VrtlAcct>
Group of Accounts ID	<GOAId>GOAVAFR001</GOAId>
End of Virtual Account	</VrtlAcct>
Consolidated Information	<CnsltdInf>
Group of Accounts ID	<GOAId>GOACIFR001</GOAId>
End of Consolidated Information	</CnsltdInf>
Activation Date	<ActDt>2013-03-08</ActDt>
Contingency Account Number	<CtgnCyAcctNb>FRCM000000000001</CtgnCyAcctNb>
End of Account Information	</AcctInf>
End of RTGS Account	</RTGSAcct>
End of Message Type	</ModifyRTGSAccount>
End of SSP Proprietary Data	</SspPrtryDt>
End of Proprietary Data	</Data>
End proprietary message	</PrtryMsg>

6. 5.28 ModifySFAccount (for CBs only)

SSP Proprietary Messages

ModifySFAccount_SD

Scope: Aim :
It is used to create or modify SF account.

Precondition :

- The user is logged in and is allowed, thanks to his pre-defined role, to use this transaction.
- The requestor must know precisely the BIC11 identifying the related participant, owner of the SF account and the responsible Central Bank.
- Data used by requestor to enter or modify information on SF account may be:
 - SF account number for Marginal Lending
 - SF account number for Overnight Deposit
 - Module used for settlement
 - Activation date of the update

XML Request :
Modify SF Account

XML Response :
Receipt

<camt.998.001.xx>

Structure:

Name Proprietary message	<PrtryMsg>
Message Header	<MsgHdr>
Message Identification	<MsgId></MsgId>
End of Message Header	</MsgHdr>
Proprietary Data	<PrtryData>
Proprietary Data type	<Tp>ModifySFAccount</Tp>
Proprietary Data	<Data>
SSP Proprietary Data	<SspPrtryDt>
Message Type	<ModifySFAccount>
SF Account	<StgFcltsAcct>
CB Responsible	<Ctry></Ctry>
BIC	<BIC></BIC>
Record Status all Modify and Delete messages	<RecSts></RecSts>
Account Information	<AcctInf>
Update Flag	<UpdtFlag></UpdtFlag>
SF Account Number Marginal Lending	<StgFcltsAcctNbMgLd></StgFcltsAcctNbMgLd>
SF Account Number Overnight Deposit	<StgFcltsAcctNbOnDp></StgFcltsAcctNbOnDp>
Module of Settlement for SF Accounts	<MdleSettl></MdleSettl>
Activation Date	<ActDt></ActDt>
End of Account Information	</AcctInf>
End of SF Account	</StgFcltsAcct>
End of Message Type	</ModifySFAccount>
End of SSP Proprietary Data	</SspPrtryDt>
End of Proprietary Data	</Data>
End of Proprietary Data	</PrtryData>
End proprietary message	</PrtryMsg>

Attributes:

name of attribute	format	short description	description
<PrtryMsg>		Name Proprietary message Mandatory	Validation:
<MsgHdr>		Message Header Mandatory	Set of characteristics specific to the message Validation: [1..1]
<MsgId>-</MsgId>	35x	Message Identification Mandatory	Message Identification Validation: [1..1]
</MsgHdr>		End of Message Header Mandatory	Validation: [1..1]
<PrtryData>		Proprietary Data Mandatory	Proprietary Data Validation: [1..1]
<Tp>-</Tp>	35x	Proprietary Data type Mandatory	Proprietary Data type defines the Type of the free format XML Validation: [1..1]
<Data>		Proprietary Data Mandatory	Proprietary data content Validation: [1..1]
<SspPrtryDt>		SSP Proprietary Data Mandatory	Root element for all SSP proprietary data Validation: [1..1]
<ModifySFAccount>		Message Type Mandatory	Message Type for Static Data Validation: [1..1]
<StgFcltsAcct>		SF Account Mandatory	SF Account Validation: [1..1]
<Ctry>-</Ctry>	2!c	CB Responsible Mandatory	Country Code of the Responsible CB. Validation: [1..1]
<BIC>-</BIC>	4!a2!a2!c3!c	BIC Mandatory	A code allocated to a financial institution by a Registration Authority under an international identification scheme, as described in the latest edition of the international standard ISO 9362 "Banking - Banking telecommunication messages - Bank identifier codes". BIC 11 of the SF Account Holder (BIC Participant). Validation: [1..1]

name of attribute	format	short description	description
<RecSts>-</RecSts>	2x	Record Status all Modify and Delete messages	Status of the record. List of values : "AC" for Active "FU" for Future "IC" for In Change For more information on status management, please read the ICM UserHandBook. Optional Validation: [0..1]If Update Flag is equal to N then the <RecSts> is optional If Update Flag is equal to U then the <RecSts> is mandatory
<AcctInf>		Account Information Mandatory	Account Information Validation: [1..1]
<UpdtFlag>-</UpdtFlag>	1!a	Update Flag Mandatory	Flag used in "Modify" XML Message to indicate the type of update : "N" for new entry "U" for update of an existing entry Validation: [1..1] If Update Flag is equal to N then the <RecSts> is optional If Update Flag is equal to U then the <RecSts> is mandatory
<StgFcltsAcctNbMgLd>-</StgFcltsAcctNbMgLd>	2!c32x	SF Account Number Marginal Lending Mandatory	Account Code. Lenght 34 characters Validation: [0..1]
<StgFcltsAcctNbOnDp>-</StgFcltsAcctNbOnDp>	2!c32x	SF Account Number Overnight Deposit Mandatory	Account Code. Lenght 34 characters Validation: [1..1]
<MdleSettl>-</MdleSettl>	4c	Module of Settlement for SF Accounts Mandatory	Module of Settlement for SF Accounts. List of allowed values is : - RTGS - HAM Validation: [1..1]
<ActDt>-</ActDt>	ISODate	Activation Date Mandatory	Date within a particular calendar year represented by YYYY-MM-DD (ISO 8601). Validation: [1..1]
</AcctInf>		End of Account Information Mandatory	End of Account Information Validation: [1..1]
</StgFcltsAcct>		End of SF Account Mandatory	End of SF Account Validation: [1..1]
</ModifySFAccount>		End of Message Type	End of Message Type for Static Data

name of attribute	format	short description	description
		Mandatory	Validation: [1..1]
</SspPrtryDt>		End of SSP Proprietary Data Mandatory	End of Root element for all SSP proprietary data Validation: [1..1]
</Data>		End of Proprietary Data Mandatory	Validation: [1..1]
</PrtryData>		End of Proprietary Data Mandatory	End of Proprietary Data Validation: [1..1]
</PrtryMsg>		End proprietary message Mandatory	Validation:

Error Codes:

Order	Error code				Error Text / Validation/ Remark
	SSP	Y-copy	V-shape	XML	
1	X41			1401	Error Text: No permission. RBAC User role(s) are not sufficient. Validation: RBAC role name "APPLICBTE" is required Remark: checked by ICM / Receipt
2	X44			1404	Error Text: If "non repudiation of emission" is mandatory, the NRE indicator flag has to be present Validation: If non-repudiaton processing is mandatory, the tag <SwInt:NRIndicator>TRUE</SwInt:NRIndicator> has to be present. Remark: Receipt /checked by ICM

ModifySFAccount_SD_1

Scope: Create a SF account

Name Proprietary message	<PrtryMsg>
Message Header	<MsgHdr>
Message Identification	<MsgId>CREATESFAcc1403A</MsgId>
End of Message Header	</MsgHdr>
Proprietary Data	<PrtryData>
Proprietary Data type	<Tp>ModifySFAccount</Tp>
Proprietary Data	<Data>
SSP Proprietary Data	<SspPrtryDt>
Message Type	<ModifySFAccount>
SF Account	<StgFcltsAcct>
CB Responsible	<Ctry>ES</Ctry>
BIC	<BIC>ZYAJFRT0HSD</BIC>
Record Status all Modify and Delete messages	<RecSts>FU</RecSts>
Account Information	<AcctInf>
Update Flag	<UpdtFlag>N</UpdtFlag>
SF Account Number Marginal Lending	<StgFcltsAcctNbMgLd>ESZYAJFRT0HSDML1</StgFcltsAcctNbMgLd>
SF Account Number Overnight Deposit	<StgFcltsAcctNbOnDp>ESZYAJFRT0HSDOD1</StgFcltsAcctNbOnDp>
Module of Settlement for SF Accounts	<MdleSettl>RTGS</MdleSettl>
Activation Date	<ActDt>2012-03-15</ActDt>
End of Account Information	</AcctInf>
End of SF Account	</StgFcltsAcct>
End of Message Type	</ModifySFAccount>
End of SSP Proprietary Data	</SspPrtryDt>
End of Proprietary Data	</Data>
End of Proprietary Data	</PrtryData>
End proprietary message	</PrtryMsg>

ModifySFAccount_SD_2

Scope: Modify a SF account

Name Proprietary message	<PrtryMsg>
Message Header	<MsgHdr>
Message Identification	<Msgld>MODIFSFAcc0804A</Msgld>
End of Message Header	</MsgHdr>
Proprietary Data	<PrtryData>
Proprietary Data type	<Tp>ModifySFAccount</Tp>
Proprietary Data	<Data>
SSP Proprietary Data	<SspPrtryDt>
Message Type	<ModifySFAccount>
SF Account	<StgFcltsAcct>
CB Responsible	<Ctry>ES</Ctry>
BIC	<BIC>ZYAJFRT0HSD</BIC>
Record Status all Modify and Delete messages	<RecSts>FU</RecSts>
Account Information	<AcctInf>
Update Flag	<UpdtFlag>U</UpdtFlag>
SF Account Number Marginal Lending	<StgFcltsAcctNbMgLd>ESZYAJFRT0HSDML2</StgFcltsAcctNbMgLd>
SF Account Number Overnight Deposit	<StgFcltsAcctNbOnDp>ESZYAJFRT0HSDML2</StgFcltsAcctNbOnDp>
Module of Settlement for SF Accounts	<MdleSettl>RTGS</MdleSettl>
Activation Date	<ActDt>2012-08-07</ActDt>
End of Account Information	</AcctInf>
End of SF Account	</StgFcltsAcct>
End of Message Type	</ModifySFAccount>
End of SSP Proprietary Data	</SspPrtryDt>
End of Proprietary Data	</Data>
End of Proprietary Data	</PrtryData>
End proprietary message	</PrtryMsg>

6. 5.29 ModifyStandingOrder

Cash Management Standard

ModifyStandingOrder _SD

M

Scope: The ModifyStandingOrder message is used to

- define a standing order liquidity transfer from the RTGS account to the sub-account
- modify a standing order liquidity transfer from the RTGS account to the sub-account
- define a standing order liquidity transfer from the RTGS account to DCAs in T2S or TIPS accounts in TIPS
- modify a standing order liquidity transfer from the RTGS account to DCAs in T2S or TIPS accounts in TIPS

Hint: a modification to 0 euro deletes a standing order

The ModifyStandingOrder message can be sent by the application of a direct PM participant or the application of a group of accounts manager (for the latter only from RTGS account to sub-account).

The ModifyStandingOrder message is replied by a Receipt message. Non-Repudiation of Emission (NRE) is supported.

<camt.024.001.xx>

Structure:

Message name for ModifyStandingOrder	<ModifyStgOrdr>
Message Header	<MsgHdr>
Message Identification	<MsgId></MsgId>
End of Message Header	</MsgHdr>
Identification of the standing order	<StgOrdrId>
Account Identification	<Acct>
Identification	<Id>
GenericAccountIdentification	<Othr>
Identification	<Id></Id>
End of GenericAccountIdentification	</Othr>
End Identification	</Id>
CashAccountType	<Tp>
Nature or use of the account in a proprietary form.	<Prtry></Prtry>
End of CashAccountType	</Tp>
End of Account	</Acct>
End of Standing order Id	</StgOrdrId>
Standing order details	<NewStgOrdrValSet>
Amount	<Amt>
Amount without currency	<AmtWthtCcy></AmtWthtCcy>
End of Amount	</Amt>
CreditorAccount	<CdtrAcct>
Identification	<Id>
GenericAccountIdentification	<Othr>
Identification	<Id></Id>
End of GenericAccountIdentification	</Othr>
End Identification	</Id>
EndCreditorAccount	</CdtrAcct>
Frequency	<Frqcy></Frqcy>
End of Standing order details	</NewStgOrdrValSet>
End of Message name for ModifyStandingOrder	</ModifyStgOrdr>

M
M

M

Attributes:

name of attribute	format	short description	description
<ModifyStgOrd>		Message name for ModifyStandingOrder Mandatory A2A	Message name for ModifyStandingOrder Validation:
<MsgHdr>		Message Header Mandatory A2A	Set of characteristics specific to the message Validation: [1..1]
<MsgId>-</MsgId>	35x	Message Identification Mandatory A2A	Message Identification Validation: [1..1]
</MsgHdr>		End of Message Header Mandatory A2A	Validation: [1..1]
<StgOrdId>		Identification of the standing order Mandatory A2A	Validation: [1..1]
<Acct>		Account Identification Mandatory	Validation: [1..1]
<Id>		Identification Mandatory A2A	debited account: account number of RTGS Main Account Validation: [1..1]
<Othr>		GenericAccountIdentification Mandatory A2A	GenericAccountIdentification Validation: [1..1]
<Id>-</Id>	34x	Identification Mandatory A2A	Name or number assigned by an entity to enable recognition of that entity, eg, account identifier. Validation: [1..1] main account of the participant
</Othr>		End of GenericAccountIdentification Mandatory A2A	End of GenericAccountIdentification Validation: [1..1]
</Id>		End Identification Mandatory A2A	End Identification Validation: [1..1]
<Tp>		CashAccountType Optional	CashAccountType Validation: [0..1] Only allowed if order type is ModifyStandingOrder to DCA or TIPS

M

name of attribute	format	short description	description
<Prtry>-</Prtry>	35x	Nature or use of the account in a proprietary form. Mandatory	Possible values only in case of StandingOrder to DCA: CREA = creation UPDA = update CREATIPS = creation of a SO TIPS UPDATIPS = update of a SO TIPS Validation: [1..1]
</Tp>		End of CashAccountType Optional	End of CashAccountType Validation: [0..1]
</Acct>		End of Account Mandatory	Validation: [1..1]
</StgOrdrlid>		End of Standing order Id Mandatory A2A	End Standing order Id Validation: [1..1]
<NewStgOrdrValSet>		Standing order details Mandatory A2A	Standing order details New standing order value Validation: [1..1]
<Amt>		Amount Mandatory A2A	Validation: [1..1]
<AmtWthtCcy>-</AmtWthtCcy>	18n	Amount without currency Mandatory A2A	Number of monetary units specified in a currency where the unit of currency is implied by the context. The integer part of Amount must contain at least one digit. The decimal separator is a dot '.'. It is not mandatory but included in the maximum length. The number of digits following the dot must not exceed the maximum number allowed for that specific currency as specified in ISO 4217. Standing Order New (Euro) entered data for liquidity injection for daylight or night-time processing Validation: [1..1] in PM 2 fraction digits are foreseen
</Amt>		End of Amount Mandatory A2A	End of Amount Validation: [1..1]
<CdtrAcct>		CreditorAccount Mandatory A2A	credited account RTGS / sub-account / DCA / TIPS account Validation: [1..1]
<Id>		Identification Mandatory A2A	Identification Unique and unambiguous identification for the account between the account owner and the account servicer. Validation: [1..1]

name of attribute	format	short description	description
<Othr>		GenericAccountIdentification Mandatory A2A	GenericAccountIdentification Validation: [1..1]
<Id>-</Id>	34x	Identification Mandatory A2A	Name or number assigned by an entity to enable recognition of that entity, eg, account identifier. Validation: [1..1]
</Othr>		End of GenericAccountIdentification Mandatory A2A	End of GenericAccountIdentification Validation: [1..1]
</Id>		End Identification Mandatory A2A	End Identification Validation: [1..1]
</CdtrAcct>		EndCreditorAccount Mandatory A2A	Validation: [1..1]
<Frqcy>		Frequency Mandatory A2A	needed to define nighttime and daylight processing DAIL = Standing Order for Daytime - Processing OVNG = Standing Order for Nighttime - Processing Validation: [1..1]
</NewStgOrdrValSet>		End of Standing order details Mandatory A2A	End Standing order details Validation: [1..1]
</ModifyStgOrdr>		End of Messagename for ModifyStandingOrder Mandatory A2A	Validation:

Error Codes:

Order	Error code				Error Text / Validation/ Remark
	SSP	Y-copy	V-shape	XML	
	X66	TL		1426	<p>Error Text: The TIPS Account must be linked to a RTGS account related to the sender. A</p> <p>Validation: IF TIPS Account is not linked to RTGS Account of the sender</p> <p>Remark: only relevant for ModifyStandingorder TIPS</p>
1	X00			0000	<p>Error Text: O.k.</p> <p>Validation: Confirmation, that a task is stored in the task queue. A related reference for the subsequent processing (e.g. confirmation) of the task is returned.</p> <p>Remark: Receipt (status code)</p>
2	X41			1401	<p>Error Text: No permission. RBAC User role(s) are not sufficient.</p> <p>Validation: RBAC role name "APPLICATE", "APPLICSTE" or "APPLICBTE" are required</p> <p>Remark: checked by ICM / Receipt</p>
3	X44			1404	<p>Error Text: If "non repudiation of emission" is mandatory, the NRE indicator flag has to be present</p> <p>Validation: If non-repudiaton processing is mandatory, the tag <SwInt:NRIndicator>TRUE</SwInt:NRIndicator> has to be present.</p> <p>Remark: to checked by ICM / Receipt</p>
4	X45			1405	<p>Error Text: No authorisation or rather interaction not possible. User is not allowed acting on behalf of another participant as Group of Account manager</p> <p>Validation: CdtAcct/Id/DmstAcct/Id (profile group of accounts manager) value must indicate a sub-account that belongs to a member of the group of accounts the participant is the manager of</p> <p>Remark: ckecked by ICM / Receipt</p>
5	X47			1407	<p>Error Text: No authorisation. User is not allowed acting on behalf of another Participant as Central Bank</p> <p>Validation: CdtAcct/Id/DmstAcct/Id (profile central bank) value must indicate a sub-account that belongs to the central bank itself or to a participant the central bank is responsible for</p> <p>Remark: ckecked by ICM / Receipt</p>
6	X42			1402	<p>Error Text: No authorisation. User is not allowed acting on behalf of another participant.</p> <p>Validation: CdtAcct/Id/DmstAcct/Id (profile credit institution) value must indicate a sub-account that belongs to the credit institution itself or to a participant the credit institution is entitled to act on behalf of</p> <p>Remark: ckecked by ICM / Receipt</p>
7	X47			1407	<p>Error Text: No authorisation. User is not allowed acting on behalf of another Participant as Central Bank</p> <p>Validation: AcctId/DmstAcct/Id (profile central bank) value must indicate a main-account that belongs to a member of the group of accounts the participant is the manager of</p> <p>Remark: ckecked by ICM / Receipt</p>
8	X45			1405	<p>Error Text: No authorisation or rather interaction not possible. User is not allowed acting on behalf of another participant as Group of Account manager</p> <p>Validation: AcctId/DmstAcct/Id (profile group of accounts manager) value must indicate a main-account that belongs to a member of the group of accounts the participant is the manager of</p> <p>Remark: ckecked by ICM / Receipt</p>
8	X42			1402	<p>Error Text: No authorisation. User is not allowed acting on behalf of another</p>

Order	Error code				Error Text / Validation/ Remark
	SSP	Y-copy	V-shape	XML	
					<p>participant.</p> <p>Validation: AcctId/DmstAcct/Id (profile credit institution) value must indicate a main-account that belongs to the credit institution itself or to a participant the credit institution is entitled to act on behalf of</p> <p>Remark: ckecked by ICM / Receipt</p>
9	T56	T6		T056	<p>Error Text: Message type not supported.</p> <p>Validation: IF SSP parameter SWITCH_T2S_SD = Off</p> <p>Remark: only relevant for ModifyStandingOrderDCA</p>

ModifyStandingOrder_SD_1

Scope: Request for modification of standing order:direction from RTGS main account to sub account, for daytime processing.

MessageName for ModifyStandingOrder	<ModfyStgOrdr>
Message Header	<MsgHdr>
Message Identification	<MsgId>ABC123456</MsgId>
End of Message Header	</MsgHdr>
Identification of the standing order	<StgOrdrId>
Account Identification	<Acct>
Identification	<Id>
GenericAccountIdentification	<Othr>
Identification	<Id>BE671234567891223456783</Id>
End of GenericAccountIdentification	</Othr>
End Identification	</Id>
End of Account	</Acct>
End of Standing order Id	</StgOrdrId>
Standing order details	<NewStgOrdrValSet>
Amount	<Amt>
Amount without currency	<AmtWthtCcy>500000.00</AmtWthtCcy>
End of Amount	</Amt>
CreditorAccount	<CdtrAcct>
Identification	<Id>
GenericAccountIdentification	<Othr>
Identification	<Id>BE6700006789122345678</Id>
End of GenericAccountIdentification	</Othr>
End Identification	</Id>
EndCreditorAccount	</CdtrAcct>
Frequency	<Frqcy>DAIL</Frqcy>
End of Standing order details	</NewStgOrdrValSet>
End of MessageName for ModifyStandingOrder	</ModfyStgOrdr>

ModifyStandingOrder_SD_2

Scope: Request for modification of standing order: Direction from RTGS main account to sub-account, nighttime processing

MessageName for ModifyStandingOrder	<ModfyStgOrdr>
Message Header	<MsgHdr>
Message Identification	<Msgld>ABC12365</Msgld>
End of Message Header	</MsgHdr>
Identification of the standing order	<StgOrdrld>
Account Identification	<Acct>
Identification	<ld>
GenericAccountIdentification	<Othr>
Identification	<ld>BE671234567891223456783</ld>
End of GenericAccountIdentification	</Othr>
End Identification	</ld>
End of Account	</Acct>
End of Standing order Id	</StgOrdrld>
Standing order details	<NewStgOrdrValSet>
Amount	<Amt>
Amount without currency	<AmtWthtCcy>500000.00</AmtWthtCcy>
End of Amount	</Amt>
CreditorAccount	<CdtrAcct>
Identification	<ld>
GenericAccountIdentification	<Othr>
Identification	<ld>BE6700006789122345678</ld>
End of GenericAccountIdentification	</Othr>
End Identification	</ld>
EndCreditorAccount	</CdtrAcct>
Frequency	<Frqcy>OVNG</Frqcy>
End of Standing order details	</NewStgOrdrValSet>
End of MessageName for ModifyStandingOrder	</ModfyStgOrdr>

ModifyStandingOrder_SD_3

Scope: Modification of a Standing Order from RTGS account to a DCA in T2S

Messagename for ModifyStandingOrder	<ModfyStgOrdr>
Message Header	<MsgHdr>
Message Identification	<MsgId>ABC123</MsgId>
End of Message Header	</MsgHdr>
Identification of the standing order	<StgOrdrId>
Account Identification	<Acct>
Identification	<Id>
GenericAccountIdentification	<Othr>
Identification	<Id>RTGSBE3456789122345678323456789123</Id>
End of GenericAccountIdentification	</Othr>
End Identification	</Id>
CashAccountType	<Tp>
Nature or use of the account in a proprietary form.	<Prtry>UPDA</Prtry>
End of CashAccountType	</Tp>
End of Account	</Acct>
End of Standing order Id	</StgOrdrId>
Standing order details	<NewStgOrdrValSet>
Amount	<Amt>
Amount without currency	<AmtWthtCcy>500000.00</AmtWthtCcy>
End of Amount	</Amt>
CreditorAccount	<CdtrAcct>
Identification	<Id>
GenericAccountIdentification	<Othr>
Identification	<Id>DCABE23456789122345678323456789123</Id>
End of GenericAccountIdentification	</Othr>
End Identification	</Id>
EndCreditorAccount	</CdtrAcct>
Frequency	<Frqcy>OVNG</Frqcy>
End of Standing order details	</NewStgOrdrValSet>
End of Messagename for ModifyStandingOrder	</ModfyStgOrdr>

ModifyStandingOrder_SD_4

A

Scope: Modification of a Standing Order from RTGS account to TIPS Account

MessageName for ModifyStandingOrder	<ModfyStgOrdr>	A
Message Header	<MsgHdr>	A
Message Identification	<MsgId>ABC123</MsgId>	A
End of Message Header	</MsgHdr>	A
Identification of the standing order	<StgOrdrId>	A
Account Identification	<Acct>	A
Identification	<Id>	A
GenericAccountIdentification	<Othr>	A
Identification	<Id>RTGSBE3456789122345678323456789123</Id>	A
End of GenericAccountIdentification	</Othr>	A
End Identification	</Id>	A
CashAccountType	<Tp>	A
Nature or use of the account in a proprietary form.	<Prtry>UPDATIPS</Prtry>	A
End of CashAccountType	</Tp>	A
End of Account	</Acct>	A
End of Standing order Id	</StgOrdrId>	A
Standing order details	<NewStgOrdrValSet>	A
Amount	<Amt>	A
Amount without currency	<AmtWthtCcy>500000.00</AmtWthtCcy>	A
End of Amount	</Amt>	A
CreditorAccount	<CdtrAcct>	A
Identification	<Id>	A
GenericAccountIdentification	<Othr>	A
Identification	<Id>TIPSBE1234567891223456789</Id>	A
End of GenericAccountIdentification	</Othr>	A
End Identification	</Id>	A
EndCreditorAccount	</CdtrAcct>	A
Frequency	<Frqcy>OVNG</Frqcy>	A
End of Standing order details	</NewStgOrdrValSet>	A
End of MessageName for ModifyStandingOrder	</ModfyStgOrdr>	A

6. 5.30 ModifyStandingOrderMirror (for Technical account - procedure 6 real-time)

SSP Proprietary Messages

ModifyStandingOrderMirror_SD

Scope: This message is used to modify or to create a standing order Technical account - procedure 6 real-time. The only possible field for modification is the amount. Setting the amount to 0 is equivalent to deleting the SO. A SO is modified by indicating its internal id as returned in the field StgMirrorId of ReturnStandingOrderMirror.

A SO is created by specifying a new set of attributes.

<camt.998.001.xx>

Structure:

Name Proprietary message	<PrtryMsg>
Message Header	<MsgHdr>
Message Identification	<MsgId></MsgId>
End of Message Header	</MsgHdr>
Proprietary Data	<PrtryData>
Proprietary Data type	<Tp>ModifyStandingOrderMirror</Tp>
Proprietary Data	<Data>
SSP Proprietary Data	<SspPrtryDt>
Message type for static data	<ModifyStandingOrderMirror>
choice	xorCreateModify
Container for new standing order	<NewStgOrdr>
Identification of the Standing Order Sender	<StgOrdrId>
Participant Identification	<PtcptId>
BIC	<BIC></BIC>
End of Participant Identification	</PtcptId>
End of Standing Order Id Sender	</StgOrdrId>
Definition of new standing order attributes	<NewStgOrdrValSet>
Amount	<Amt>
Amount without currency	<AmtWthtCcy></AmtWthtCcy>
End of Amount	</Amt>
Debtor	<Dbtr>
Financial institution	<FI>
BIC	<BIC></BIC>
End of financial institution	</FI>
End of debtor	</Dbtr>
Creditor	<Cdtr>
Financial institution	<FI>
BIC	<BIC></BIC>
End of financial institution	</FI>
End of Creditor	</Cdtr>
CreditorAccount	<CdtrAcct>
Simple Identification Information	<DmstAcct>
Identification	<Id></Id>
End of simple Identification Information	</DmstAcct>
EndCreditorAccount	</CdtrAcct>
Final agent	<FnIAgt>
BIC	<BIC></BIC>
End of Final Agent	</FnIAgt>
RemittanceInformation	<RmtInf>
Unstructured	<Ustrd></Ustrd>
EndRemittanceInformation	</RmtInf>
Frequency	<Frqcy></Frqcy>

List of standing orders (end)	</NewStgOrdrValSet>
Container for new standing order (End)	</NewStgOrdr>
Container for modified standing order	<ModStgOrdr>
Identification of the standing order	<StgMirrorId></StgMirrorId>
Amount	<Amt>
Amount without currency	<AmtWthtCcy></AmtWthtCcy>
End of Amount	</Amt>
Container for modified standing order (End)	</ModStgOrdr>
End choice	/xorCreateModify
Message type for static data (End)	</ModifyStandingOrderMirror>
End of SSP Proprietary Data	</SspPrtryDt>
End of Proprietary Data	</Data>
End of Proprietary Data	</PrtryData>
End proprietary message	</PrtryMsg>

Attributes:

name of attribute	format	short description	description
<PrtryMsg>		Name Proprietary message Mandatory	Validation:
<MsgHdr>		Message Header Mandatory	Set of characteristics specific to the message Validation: [1..1]
<MsgId>-</MsgId>	35x	Message Identification Mandatory	Message Identification Validation: [1..1]
</MsgHdr>		End of Message Header Mandatory	Validation: [1..1]
<PrtryData>		Proprietary Data Mandatory	Proprietary Data Validation: [1..1]
<Tp>-</Tp>	35x	Proprietary Data type Mandatory	Proprietary Data type defines the Type of the free format XML Validation: [1..1] Here the value should be ModifyStandingOrderMirror
<Data>		Proprietary Data Mandatory	Proprietary data content Validation: [1..1]
<SspPrtryDt>		SSP Proprietary Data Mandatory	SSP Proprietary Data Validation: [1..1]
<ModifyStandingOrderMirror>		Message type for static data Mandatory	Validation: [1..1]
xorCreateModify		choice Mandatory	Choice between create or modify standing order Validation: It is mandatory that <NewStgOrder> element or <ModStgOrder> is present.
<NewStgOrdr>		Container for new standing order Mandatory	Validation: [1..1]
<StgOrdrId>		Identification of the Standing Order Sender Mandatory	Validation: [1..1]
<PtcptId>		Participant Identification	Participant Identification

name of attribute	format	short description	description
		Mandatory	Validation: [1..1]
<BIC>-</BIC>	11x	BIC	BICIdentifier Code allocated to financial institutions by the Registration Authority, under an international identification scheme, as described in the latest version of the standard ISO 9362 "Banking - Banking telecommunication messages - Bank Identifier Codes". SWIFT is the Registration Authority for ISO 9362. BIC of settlement bank
		Mandatory	Validation: [1..1]
</Pcptld>		End of Participant Identification	End of Participant Identification
		Mandatory	Validation: [1..1]
</StgOrdrlid>		End of Standing Order Id Sender	
		Mandatory	Validation: [1..1]
<NewStgOrdValSet>		Definition of new standing order attributes	Definition of new standing order attributes
		Mandatory	Validation: [1..1]
<Amt>		Amount	
		Mandatory	Validation: [1..1]
<AmtWthtCcy>-</AmtWthtCcy>	18n	Amount without currency	
		Mandatory	Validation: [1..1]
</Amt>		End of Amount	
		Mandatory	Validation: [1..1]
<Dbtr>		Debtor	Information about the debtor of a payment.
		Optional	Validation: [0..1]
<FI>		Financial institution	Financial institution
		Mandatory	Validation: [1..1]
<BIC>-</BIC>	11x	BIC	BIC BIC 52 of the standing order
		Mandatory	Validation: [1..1]
</FI>		End of financial institution	End of financial institution
		Mandatory	Validation: [1..1]
</Dbtr>		End of debtor	

name of attribute	format	short description	description
		Optional	Validation: [0..1]
<Cdtr>		Creditor Optional	Validation: [0..1]
<FI>		Financial institution Mandatory	Financial institution Validation: [1..1]
<BIC>-</BIC>	11x	BIC Mandatory	BIC BIC 58 of the standing order Validation: [1..1]
</FI>		End of financial institution Mandatory	End of financial institution Validation: [1..1]
</Cdtr>		End of Creditor Optional	Validation: [0..1]
<CdtrAcct>		CreditorAccount Optional	Validation: [0..1]
<DmstAcct>		Simple Identification Information Mandatory	Simple Identification Information Validation: [1..1]
<Id>-</Id>	34x	Identification Mandatory	Name or number assigned by an entity to enable recognition of that entity, eg, account identifier. Account numer for field 58 of the SO Validation: [1..1]
</DmstAcct>		End of simple Identification Information Mandatory	Validation: [1..1]
</CdtrAcct>		EndCreditorAccount Optional	Validation: [0..1]
<FnIAgt>		Final agent Mandatory	BIC of Technical account - procedure 6 real-time Validation: [1..1]
<BIC>-</BIC>	11x	BIC Mandatory	BIC Validation: [1..1]
</FnIAgt>		End of Final Agent Mandatory	End of Final Agent Validation:

name of attribute	format	short description	description
			[1..1]
<RmtInf>		RemittanceInformation Optional	Validation: [0..1]
<Ustrd>-</Ustrd>	140x	Unstructured Mandatory	Field 72 of the standing order Validation: [1..1] Not checked
</RmtInf>		EndRemittanceInformation Optional	Validation: [0..1]
<Frqcy>-</Frqcy>	4x	Frequency Mandatory	Validation: [1..1]Frequency of SO. In the case of SO Technical account - procedure 6 real-time the value is always OVNG.
</NewStgOrdrValSet>		List of standing orders (end) Mandatory	Validation: [1..1]
</NewStgOrdr>		Container for new standing order (End) Mandatory	Validation: [1..1]
<ModStgOrdr>		Container for modified standing order Mandatory	Validation: [1..1]
<StgMirrorId>-</StgMirrorId>	18x	Identification of the standing order Mandatory	Identification of the standing order. This Id will be used to modify an existing standing Order. Currently this should be the id of the standing order. Validation: [1..1]
<Amt>		Amount Mandatory	Validation: [1..1]
<AmtWthtCcy>-</AmtWthtCcy>	18n	Amount without currency Mandatory	Number of monetary units specified in a currency where the unit of currency is implied by the context. The integer part of Amount must contain at least one digit. The decimal separator is a dot '.'. It is not mandatory but included in the maximum length. The number of digits following the dot must not exceed the maximum number allowed for that specific currency as specified in ISO 4217. Validation: [1..1] Amount must be superior or equal to 0.
</Amt>		End of Amount Mandatory	Validation:

name of attribute	format	short description	description
			[1..1]
</ModStgOrdr>		Container for modified standing order (End) Mandatory	Validation: [1..1]
/xorCreateModify		End choice Mandatory	Choice between create or modify standing order (End) Validation:
</ModifyStandingOrderMirror>		Message type for static data (End) Mandatory	Validation: [1..1]
</SspPrtryDt>		End of SSP Proprietary Data Mandatory	End of Root element for all SSP proprietary data Validation: [1..1]
</Data>		End of Proprietary Data Mandatory	Validation: [1..1]
</PrtryData>		End of Proprietary Data Mandatory	End of Proprietary Data Validation: [1..1]
</PrtryMsg>		End proprietary message Mandatory	Validation:

Error Codes:

Order	Error code				Error Text / Validation/ Remark
	SSP	Y-copy	V-shape	XML	
1	X41			1401	Error Text: No permission. RBAC User role(s) are not sufficient. Validation: RBAC role name "APPLICBTE", "APPLICSTE" or "APPLICATE" are required Remark: checked by ICM / Receipt
2	X44			1404	Error Text: If "non repudiation of emission" is mandatory, the NRE indicator flag has to be present Validation: If non-repudiaton processing is mandatory, the tag <SwInt:NRIndicator>TRUE</SwInt:NRIndicator> has to be present. Remark: Receipt /checked by ICM

ModifyStandingOrderMirror_SD_1

Scope: Sample for creation of standing order Technical account- procedure 6 real-time

Name Proprietary message	<PrtryMsg>
Message Header	<MsgHdr>
Message Identification	<MsgId>ABC123</MsgId>
End of Message Header	</MsgHdr>
Proprietary Data	<PrtryData>
Proprietary Data type	<Tp>ModifyStandingOrderMirror</Tp>
Proprietary Data	<Data>
SSP Proprietary Data	<SspPrtryDt>
Message type for static data	<ModifyStandingOrderMirror>
Container for new standing order	<NewStgOrdr>
Identification of the Standing Order Sender	<StgOrdrId>
Participant Identification	<PtcptId>
BIC	<BIC>SETTBANKBIC</BIC>
End of Participant Identification	</PtcptId>
End of Standing Order Id Sender	</StgOrdrId>
Definition of new standing order attributes	<NewStgOrdrValSet>
Amount	<Amt>
Amount without currency	<AmtWthtCcy>500000.00</AmtWthtCcy>
End of Amount	</Amt>
Debtor	<Dbtr>
Financial institution	<FI>
BIC	<BIC>FIELDBIC52X</BIC>
End of financial institution	</FI>
End of debtor	</Dbtr>
Creditor	<Cdtr>
Financial institution	<FI>
BIC	<BIC>FIELDBIC58X</BIC>
End of financial institution	</FI>
End of Creditor	</Cdtr>
CreditorAccount	<CdtrAcct>
Simple Identification Information	<DmstAcct>
Identification	<Id>FIELD58ACCOUNT</Id>
End of simple Identification Information	</DmstAcct>
EndCreditorAccount	</CdtrAcct>
Final agent	<FnlAgt>
BIC	<BIC>MIRRORBICXX</BIC>
End of Final Agent	</FnlAgt>
RemittanceInformation	<RmtInf>
Unstructured	<Ustrd>FIELD72</Ustrd>
EndRemittanceInformation	</RmtInf>
Frequency	<Frqcy>OVNG</Frqcy>
List of standing orders (end)	</NewStgOrdrValSet>
Container for new standing order (End)	</NewStgOrdr>
Message type for static data (End)	</ModifyStandingOrderMirror>
End of SSP Proprietary Data	</SspPrtryDt>
End of Proprietary Data	</Data>
End of Proprietary Data	</PrtryData>
End proprietary message	</PrtryMsg>

ModifyStandingOrderMirror_SD_2

Scope: Sample for modification of standing order Technical account- procedure 6 real-time

Name Proprietary message	<PrtryMsg>
Message Header	<MsgHdr>
Message Identification	<MsgId>ABC123</MsgId>
End of Message Header	</MsgId>
Proprietary Data	<PrtryData>
Proprietary Data type	<Tp>ModifyStandingOrderMirror</Tp>
Proprietary Data	<Data>
SSP Proprietary Data	<SspPrtryDt>
Message type for static data	<ModifyStandingOrderMirror>
Container for modified standing order	<ModStgOrdr>
Identification of the standing order	<StgMirrorId>123456789012345678</StgMirrorId>
Amount	<Amt>
Amount without currency	<AmtWthtCcy>43000</AmtWthtCcy>
End of Amount	</Amt>
Container for modified standing order (End)	</ModStgOrdr>
Message type for static data (End)	</ModifyStandingOrderMirror>
End of SSP Proprietary Data	</SspPrtryDt>
End of Proprietary Data	</Data>
End of Proprietary Data	</PrtryData>
End proprietary message	</PrtryMsg>

6. 5.31 ModifySubAccount (for CBs only)

SSP Proprietary Messages

ModifySubAccount_SD

Scope: Aim :
It is used to create or modify sub-account.

Precondition :

- The user is logged in and is allowed, thanks to his pre-defined role, to use this transaction.
- The requestor must know precisely the BIC11 identifying the related participant, owner of the sub-account and the responsible Central Bank.
- Data used by requestor to enter or modify information on sub-account may be:
 - Sub-account name
 - Sub-account Number
 - Dedicated Ancillary System (BIC)
 - Activation date of the update

XML Request :
Modify Sub Account

XML Response :
Receipt

<camt.998.001.xx>

Structure:

Name Proprietary message	<PrtryMsg>
Message Header	<MsgHdr>
Message Identification	<MsgId></MsgId>
End of Message Header	</MsgHdr>
Proprietary Data	<PrtryData>
Proprietary Data type	<Tp>ModifySubAccount</Tp>
Proprietary Data	<Data>
SSP Proprietary Data	<SspPrtryDt>
Message Type	<ModifySubAccount>
Sub Account	<SubAcct>
CB Responsible	<Ctry></Ctry>
BIC	<BIC></BIC>
Record Status all Modify and Delete messages	<RecSts></RecSts>
Account Information	<AcctInf>
Update Flag	<UpdtFlag></UpdtFlag>
Sub Account Name	<SubAcctNm></SubAcctNm>
Sub Account Number	<SubAcctNb></SubAcctNb>
AS BIC	<ASBIC></ASBIC>
Activation Date	<ActDt></ActDt>
End of Account Information	</AcctInf>
End of Sub Account	</SubAcct>
End of Message Type	</ModifySubAccount>
End of SSP Proprietary Data	</SspPrtryDt>
End of Proprietary Data	</Data>
End of Proprietary Data	</PrtryData>
End proprietary message	</PrtryMsg>

Attributes:

name of attribute	format	short description	description
<PrtryMsg>		Name Proprietary message Mandatory	Validation:
<MsgHdr>		Message Header Mandatory	Set of characteristics specific to the message Validation: [1..1]
<MsgId>-</MsgId>	35x	Message Identification Mandatory	Message Identification Validation: [1..1]
</MsgHdr>		End of Message Header Mandatory	Validation: [1..1]
<PrtryData>		Proprietary Data Mandatory	Proprietary Data Validation: [1..1]
<Tp>-</Tp>	35x	Proprietary Data type Mandatory	Proprietary Data type defines the Type of the free format XML Validation: [1..1]
<Data>		Proprietary Data Mandatory	Proprietary data content Validation: [1..1]
<SspPrtryDt>		SSP Proprietary Data Mandatory	Root element for all SSP proprietary data Validation: [1..1]
<ModifySubAccount>		Message Type Mandatory	Message Type for Static Data Validation: [1..1]
<SubAcct>		Sub Account Mandatory	Sub Account Validation: [1..1]
<Ctry>-</Ctry>	2!c	CB Responsible Mandatory	Country Code of the Responsible CB. Validation: [1..1]
<BIC>-</BIC>	4!a2!a2!c3!c	BIC Mandatory	A code allocated to a financial institution by a Registration Authority under an international identification scheme, as described in the latest edition of the international standard ISO 9362 "Banking - Banking telecommunication messages - Bank identifier codes". In this case, this is the BIC11 of the participant, owner of the sub account. Validation:

name of attribute	format	short description	description
			[1..1]
<RecSts>-</RecSts>	2x	Record Status all Modify and Delete messages	Status of the record. List of values : "AC" for Active "FU" for Future "IC" for In Change For more information on status management, please read the ICM UserHandBook. Optional Validation: [0..1]If Update Flag is equal to N then the <RecSts> is optional If Update Flag is equal to U then the <RecSts> is mandatory
<AcctInf>		Account Information	Account Information Mandatory Validation: [1..1]
<UpdtFlag>-</UpdtFlag>	1!a	Update Flag	Flag used in "Modify" XML Message to indicate the type of update : "N" for new entry "U" for update of an existing entry Mandatory Validation: [1..1]If Update Flag is equal to N then the <RecSts> is optional If Update Flag is equal to U then the <RecSts> is mandatory
<SubAcctNm>-</SubAcctNm>	35x	Sub Account Name	Sub Account Name Mandatory Validation: [1..1]
<SubAcctNb>-</SubAcctNb>	2!c32x	Sub Account Number	Account Code. Length 34 characters. The first two characters represent the country code of the responsible CB. Mandatory Validation: [1..1]
<ASBIC>-</ASBIC>	11x	AS BIC	A code allocated to a financial institution by a Registration Authority under an international identification scheme, as described in the latest edition of the international standard ISO 9362 "Banking - Banking telecommunication messages - Bank identifier codes". In this case, this is the BIC 11 of the Ancillary System. Optional Validation: [0..1]
<ActDt>-</ActDt>	ISODate	Activation Date	Date within a particular calendar year represented by YYYY-MM-DD (ISO 8601). Mandatory Validation: [1..1]
</AcctInf>		End of Account Information	End of Account Information Mandatory Validation: [1..1]

name of attribute	format	short description	description
</SubAcct>		End of Sub Account	End of Sub Account
		Mandatory	Validation: [1..1]
</ModifySubAccount>		End of Message Type	End of Message Type for Static Data
		Mandatory	Validation: [1..1]
</SspPrtryDt>		End of SSP Proprietary Data	End of Root element for all SSP proprietary data
		Mandatory	Validation: [1..1]
</Data>		End of Proprietary Data	
		Mandatory	Validation: [1..1]
</PrtryData>		End of Proprietary Data	End of Proprietary Data
		Mandatory	Validation: [1..1]
</PrtryMsg>		End proprietary message	
		Mandatory	Validation:

Error Codes:

Order	Error code				Error Text / Validation/ Remark
	SSP	Y-copy	V-shape	XML	
1	X41			1401	Error Text: No permission. RBAC User role(s) are not sufficient. Validation: RBAC role name "APPLICBTE" is required Remark: checked by ICM / Receipt
2	X44			1404	Error Text: If "non repudiation of emission" is mandatory, the NRE indicator flag has to be present Validation: If non-repudiaton processing is mandatory, the tag <SwInt:NRIndicator>TRUE</SwInt:NRIndicator> has to be present. Remark: Receipt /checked by ICM

ModifySubAccount_SD_1

Scope: Request to create a sub account of a given participant

Name Proprietary message	<PrtryMsg>
Message Header	<MsgHdr>
Message Identification	<MsgId>ABC123</MsgId>
End of Message Header	</MsgHdr>
Proprietary Data	<PrtryData>
Proprietary Data type	<Tp>ModifySubAccount</Tp>
Proprietary Data	<Data>
SSP Proprietary Data	<SspPrtryDt>
Message Type	<ModifySubAccount>
Sub Account	<SubAcct>
CB Responsible	<Ctry>ES</Ctry>
BIC	<BIC>ZYAJFRT0HSD</BIC>
Record Status all Modify and Delete messages	<RecSts>AC</RecSts>
Account Information	<AcctInf>
Update Flag	<UpdtFlag>N</UpdtFlag>
Sub Account Name	<SubAcctNm>ZYAJFRT0HSDsub1Name</SubAcctNm>
Sub Account Number	<SubAcctNb>ESZYAJFRT0HSDsub1</SubAcctNb>
AS BIC	<ASBIC>ZYAJFRT0BAA</ASBIC>
Activation Date	<ActDt>2013-03-14</ActDt>
End of Account Information	</AcctInf>
End of Sub Account	</SubAcct>
End of Message Type	</ModifySubAccount>
End of SSP Proprietary Data	</SspPrtryDt>
End of Proprietary Data	</Data>
End of Proprietary Data	</PrtryData>
End proprietary message	</PrtryMsg>

ModifySubAccount_SD_2

Scope: Request to modify an existing sub account of a given participant

Name Proprietary message	<PrtryMsg>
Message Header	<MsgHdr>
Message Identification	<MsgId>ABC123</MsgId>
End of Message Header	</MsgHdr>
Proprietary Data	<PrtryData>
Proprietary Data type	<Tp>ModifySubAccount</Tp>
Proprietary Data	<Data>
SSP Proprietary Data	<SspPrtryDt>
Message Type	<ModifySubAccount>
Sub Account	<SubAcct>
CB Responsible	<Ctry>ES</Ctry>
BIC	<BIC>ZYAJFRT0HSD</BIC>
Record Status all Modify and Delete messages	<RecSts>AC</RecSts>
Account Information	<AcctInf>
Update Flag	<UpdtFlag>U</UpdtFlag>
Sub Account Name	<SubAcctNm>ZYAJFRT0HSDsub1Name modif</SubAcctNm>
Sub Account Number	<SubAcctNb>ESZYAJFRT0HSDsub1</SubAcctNb>
AS BIC	<ASBIC>ZYAJFRT0BAA</ASBIC>
Activation Date	<ActDt>2013-04-14</ActDt>
End of Account Information	</AcctInf>
End of Sub Account	</SubAcct>
End of Message Type	</ModifySubAccount>
End of SSP Proprietary Data	</SspPrtryDt>
End of Proprietary Data	</Data>
End of Proprietary Data	</PrtryData>
End proprietary message	</PrtryMsg>

6. 5.32 ReturnAS

SSP Proprietary Messages

ReturnAS_SD

Scope: This is the response to the XML Request : GetAS

<camt.998.001.xx>

Structure:

Name Proprietary message	<PrtryMsg>
Message Header	<MsgHdr>
Message Identification	<MsgId></MsgId>
End of Message Header	</MsgHdr>
Related	<Rltd>
Reference	<Ref></Ref>
End of Related	</Rltd>
Proprietary Data	<PrtryData>
Proprietary Data type	<Tp>ReturnAS</Tp>
Proprietary Data	<Data>
SSP Proprietary Data	<SspPrtryDt>
Message Type	<ReturnAS>
Choice amongst	<xorBizRptOprlErr>
BusinessReport	<BizRpt>
AS	<AS>
Record Status Information	<RecStsInf>
Planned Change	<PlndChng></PlndChng>
Record Status	<RecSts></RecSts>
First Activation Date	<FrstDt></FrstDt>
Modification Date	<ModDt></ModDt>
End Date	<EndDt></EndDt>
End of Record Status Information	</RecStsInf>
AS Information	<ASInf>
AS Name	<ASNm></ASNm>
AS BIC	<ASBIC></ASBIC>
DN for ASI interface	<Dnasi></Dnasi>
Packed File Delivery for ASI	<PckdFileAsi></PckdFileAsi>
Service ASI	<AsiSvc></AsiSvc>
CB Responsible	<Ctry></Ctry>
AS Type	<ASTp></ASTp>
Exclusion of an Ancillary System	<ASXclsn></ASXclsn>
Flag authorized to increase credit line	<CdtLine></CdtLine>
Settlement Model	<StlmMdl>
Settlement Model Number	<StlmMdlNb></StlmMdlNb>
AS Account Type	<ASAcctTp></ASAcctTp>
AS Account BIC	<ASAcctBIC></ASAcctBIC>
Guarantee Account BIC	<GrntyAcctBIC></GrntyAcctBIC>
Autocollateral Account BIC	<AutoCltrlBIC></AutoCltrlBIC>
AS Model 3 Notification option	<ASMDl3Not></ASMDl3Not>
AS Model 6 LiquidityTransfer Notification option	<ASMDl6LTNot></ASMDl6LTNot>
End of Settlement Model	</StlmMdl>
End of AS Information	</ASInf>
End of AS	</AS>
End of BusinessReport	</BizRpt>

OperationalError	<OprlErr>
Error handling	<Err>
Proprietary error code	<Prtry></Prtry>
End error handling	</Err>
Description	<Desc></Desc>
End of Operational Error	</OprlErr>
End of choice	</xorBizRptOprlErr>
End of Message Type	</ReturnAS>
End of SSP Proprietary Data	</SspPrtryDt>
End of Proprietary Data	</Data>
End of Proprietary Data	</PrtryData>
End proprietary message	</PrtryMsg>

Attributes:

name of attribute	format	short description	description
<PrtryMsg>		Name Proprietary message Mandatory	Validation: [1..1]
<MsgHdr>		Message Header Mandatory	Set of characteristics specific to the message Validation: [1..1]
<MsgId>-</MsgId>	35x	Message Identification Mandatory	Message Identification Validation: [1..1]
</MsgHdr>		End of Message Header Mandatory	Validation: [1..1]
<Rltd>		Related Optional	References a previously received message. Validation: [0..1]
<Ref>-</Ref>	35x	Reference Mandatory	Unique and unambiguous reference Validation: [1..1]
</Rltd>		End of Related Optional	End of Related Validation: [0..1]
<PrtryData>		Proprietary Data Optional	Proprietary Data Validation: [1..1]
<Tp>-</Tp>	35x	Proprietary Data type Mandatory	Proprietary Data type defines the Type of the free format XML Validation: [1..1]
<Data>		Proprietary Data Mandatory	Proprietary data content Validation: [1..1]
<SspPrtryDt>		SSP Proprietary Data Mandatory	Root element for all SSP proprietary data Validation: [1..1]
<ReturnAS>	35x	Message Type Mandatory	Message Type Validation: [1..1]
xorBizRptOpriErr		Choice amongst Optional	Choice amongst xorBizRptOpriErr (Type: xor) Validation:

name of attribute	format	short description	description
<BizRpt>		BusinessReport	<p>BusinessReport</p> <p>Rule rationale: The message will contain either the information matching the search criteria of the related Get message or an error indication.</p> <p>Rule description: If BusinessReport is present then OperationalError is not allowed. If BusinessReport is not present, then OperationalError is mandatory.</p> <p>Mandatory</p> <p>Validation: [1..1]</p>
<AS>		AS	<p>AS</p> <p>Mandatory</p> <p>Validation: [1..n]</p>
<RecStsInf>		Record Status Information	<p>Record Status Information</p> <p>Mandatory</p> <p>Validation: [1..1]</p>
<PlnndChng>-</PlnndChng>	1!a	Planned Change	<p>Information on record regarding the presence of a future record. Values may be :</p> <p>"N" if no future record is present "D" if the record will be deleted "M" if a future record exists</p> <p>Note : the Planned Change flag has been added in order to help users when displaying an active record. Actually, for an active record with an End Date different from '9999-12-31', it is not possible to know whether the related record will be deleted (when the system reach the End Date) or if a future record exists and will be active, as a substitute for the active one.</p> <p>The use of the Planned Change flag is made to have information on the future of an active record.</p> <p>Mandatory</p> <p>Validation: [1..1]</p>
<RecSts>-</RecSts>	2x	Record Status	<p>Status of the record. List of values :</p> <p>"AC" for Active "FU" for Future "RE" for Rejected "AR" for Archived "AF" for Archived Future "IC" for In Change "DV" for Delivery (Technical) "ID" for In Deletion (Technical)</p> <p>For more information on status management, refer to the ICM UserHandBook.</p> <p>Mandatory</p> <p>Validation: [1..1]</p>
<FrstDt>-</FrstDt>	ISODate	First Activation Date	<p>Date within a particular calendar year represented by YYYY-MM-DD (ISO 8601). This date represents the first activation date of a functional item, such as a Participant. It is different from the modification date, which is the last date when a modification occurred.</p> <p>Mandatory</p> <p>Validation: [1..1]</p>

name of attribute	format	short description	description
<ModDt>-</ModDt>	ISODate	Modification Date	Date within a particular calendar year represented by YYYY-MM-DD (ISO 8601). This is the modification date of the related record. If the record has not been modified since its activation, the modification date is equal to the first activation date. Mandatory Validation: [1..1]
<EndDt>-</EndDt>	ISODate	End Date	Date within a particular calendar year represented by YYYY-MM-DD (ISO 8601). This is the end date of the related record. Value is equal to '9999-12-31' if no modification or deletion are foreseen for this record. Otherwise, the End Date takes the value of the modification date or date of the deletion. Mandatory Validation: [1..1]
</RecStsInf>		End of Record Status Information Mandatory	End of Record Status Information Validation: [1..1]
<ASInf>		AS Information Mandatory	AS Information Validation: [1..1]
<ASNm>-</ASNm>	35x	AS Name Mandatory	This is the name of the Ancillary System. Validation: [1..1]
<ASBIC>-</ASBIC>	11x	AS BIC Mandatory	A code allocated to a financial institution by a Registration Authority under an international identification scheme, as described in the latest edition of the international standard ISO 9362 "Banking - Banking telecommunication messages - Bank identifier codes". In this case, this is the BIC 11 of the Ancillary System. Validation: [1..1]
<Dnasi>-</Dnasi>	100x	DN for ASI interface Optional	Distinguished Name, made of max 100 characters (for XML ASI messages). Validation: [0..1]
<PckdFileAsi>-</PckdFileAsi>	1!a	Packed File Delivery for ASI Optional	A flag with two values : 'Y' or 'N' This flag indicates whether the AS wants to receive all ASI SWIFTNet messages sent by the SSP in packed mode. Validation: [0..1]
<AsiSvc>-</AsiSvc>	30x	Service ASI Optional	Service (for ASI) Validation: [0..1]
<Ctry>-</Ctry>	2!c	CB Responsible	Country Code of the Responsible CB.

name of attribute	format	short description	description
		Mandatory	Validation: [1..1]
<ASTp></ASTp>	3!a	AS Type	List of values : "RTL" for Retail Payment System "LVP" for Large Value Payment System "FEX" for Foreign Exchange System "MMK" for Money Market System "CCP" for Clearing House "SSG" for Securities Settlement System, real-time "SSF" for Securities Settlement System, interfaced "MPO" for "CB using ASI for monetary policy operations"
		Mandatory	Validation: [1..1]
<ASXclsn></ASXclsn>	1!a	Exclusion of an Ancillary System	Exclusion of an Ancillary System
		Mandatory	Validation: [1..1]
<CdtLine></CdtLine>	1!a	Flag authorized to increase credit line	This flag is used for Ancillary System to know whether the relevant AS has the possibility to increase credit line of settlement bank, from the same banking community only.
		Optional	Validation: [0..1]
<SttlmMdl>		Settlement Model	Settlement Model
		Optional	Validation: [0..n]
<SttlmMdlNb></SttlmMdlNb>	2x	Settlement Model Number	Settlement Model Number. List of possible value : "1" for model 1 "2" for model 2 "3" for model 3 "4" for model 4 "5" for model 5 "6I" for model 6 interfaced "6G" for model 6 real-time
		Mandatory	Validation: [1..1]
<ASAcctTp></ASAcctTp>	35x	AS Account Type	List of values : "AST" for AS Technical Account "ASM" for Ancillary System Technical account - procedure 6 real-time
		Optional	Validation: [0..1]
<ASAcctBIC></ASAcctBIC>	4!a2!a2!c[3!c]	AS Account BIC	A code allocated to a financial institution by a Registration Authority under an international identification scheme, as described in the latest edition of the international standard ISO 9362 "Banking - Banking telecommunication messages - Bank identifier codes". In this case, the BIC 11 of the AS Account.
		Optional	Validation: [0..1]
<GrntyAcctBIC></GrntyAcctBIC>	4!a2!a2!c[3!c]	Guarantee Account BIC	A code allocated to a financial institution by a Registration Authority under an international identification scheme, as described in the latest edition of the international standard ISO 9362 "Banking - Banking telecommunication messages - Bank identifier

name of attribute	format	short description	description
			codes". In this case, this is the BIC of the Guarantee Account. Optional Validation: [0..1]
<AutoCltrlBIC>-</AutoCltrlBIC>	4!a2!a2!c[3!c]	Autocollateral Account BIC	A code allocated to a financial institution by a Registration Authority under an international identification scheme, as described in the latest edition of the international standard ISO 9362 "Banking - Banking telecommunication messages - Bank identifier codes". In this case, this is the BIC of the Auto-collateral Account. Optional Validation: [0..1]
<ASMDl3Not>-</ASMDl3Not>	1x	AS Model 3 Notification option	AS Model 3 Notification option. List of possible value : "G" for global notification "S" for single notification Optional Validation: [0..1]
<ASMDl6LTNot>-</ASMDl6LTNot>	1x	AS Model 6 LiquidityTransfer Notification option	AS Model 6 LiquidityTransfer Notification option. The content of the tag in the structure of the message should not be empty. It should be either: "Y" = Notification requested or "N" = No notification wanted. Optional Validation: [0..1]
</SttlmMdl>		End of Settlement Model	End of Settlement Model Optional Validation: [0..n]
</ASInf>		End of AS Information	End of AS Information Mandatory Validation: [1..n]
</AS>		End of AS	End of AS Mandatory Validation: [1..n]
</BizRpt>		End of BusinessReport	End of BusinessReport Mandatory Validation: [1..1]
<OpriErr>		OperationalError	Indicates an operational error Rule description: If BusinessReport is present then OperationalError is not allowed. If BusinessReport is not present, then OperationalError is mandatory. Mandatory Validation: [1..1]
<Err>		Error handling	 Mandatory Validation:

name of attribute	format	short description	description
			[1..1]
<Prtry>-</Prtry>	4x	Proprietary error code	Specification of the error, in free format.
		Mandatory	Validation: [1..1]
</Err>		End error handling	
		Mandatory	Validation: [1..1]
<Desc>-</Desc>	140x	Description	Specification of the error, in free format.
		Optional	Validation: [0..1]
</OpriErr>		End of Operational Error	End of Operational Error
		Mandatory	Validation: [1..1]
/xorBizRptOpriErr		End of choice	End of Choice
		Optional	Validation:
</ReturnAS>		End of Message Type	End of Message Type
		Mandatory	Validation: [1..1]
</SspPrtryDt>		End of SSP Proprietary Data	End of SSP Proprietary Data
		Mandatory	Validation: [1..1]
</Data>		End of Proprietary Data	
		Mandatory	Validation: [1..1]
</PrtryData>		End of Proprietary Data	End of Proprietary Data
		Mandatory	Validation: [1..1]
</PrtryMsg>		End proprietary message	
		Mandatory	Validation:

Error Codes:

ReturnAS_SD_1

Scope: Response to the XML GetAS

Name Proprietary message	<PrtryMsg>
Message Header	<MsgHdr>
Message Identification	<MsgId>RETURNABC123</MsgId>
End of Message Header	</MsgHdr>
Related	<Rltd>
Reference	<Ref>ABC123</Ref>
End of Related	</Rltd>
Proprietary Data	<PrtryData>
Proprietary Data type	<Tp>ReturnAS</Tp>
Proprietary Data	<Data>
SSP Proprietary Data	<SspPrtryDt>
Message Type	<ReturnAS>
BusinessReport	<BizRpt>
AS	<AS>
Record Status Information	<RecStsInf>
Planned Change	<PlndChng>N</PlndChng>
Record Status	<RecSts>AC</RecSts>
First Activation Date	<FrstDt>2008-06-12</FrstDt>
Modification Date	<ModDt>2011-09-28</ModDt>
End Date	<EndDt>9999-12-31</EndDt>
End of Record Status Information	</RecStsInf>
AS Information	<ASInf>
AS Name	<ASNm>ZYAJFRT0HA1</ASNm>
AS BIC	<ASBIC>ZYAJFRT0HA1</ASBIC>
DN for ASI interface	<Dnasi>cn=asi01,ou=sg2acc3fileact,o=bdfefrpp,o=swift</Dnasi>
Packed File Delivery for ASI	<PckdFileAsi>N</PckdFileAsi>
Service ASI	<AsiSvc>trgt.sfpapss!pa</AsiSvc>
CB Responsible	<Ctry>NL</Ctry>
AS Type	<ASTp>SSG</ASTp>
Exclusion of an Ancillary System	<ASXclsn>N</ASXclsn>
Flag authorized to increase credit line	<CdtLine>Y</CdtLine>
Settlement Model	<SttlmMdl>
Settlement Model Number	<SttlmMdlNb>1</SttlmMdlNb>
AS Account Type	<ASAcctTp>ASM</ASAcctTp>
AS Account BIC	<ASAcctBIC>ZYAJFRT0HM1</ASAcctBIC>
End of Settlement Model	</SttlmMdl>
Settlement Model	<SttlmMdl>
Settlement Model Number	<SttlmMdlNb>3</SttlmMdlNb>
AS Account Type	<ASAcctTp>ASM</ASAcctTp>
AS Account BIC	<ASAcctBIC>ZYAJFRT0HM1</ASAcctBIC>
AS Model 3 Notification option	<ASmdl3Not>G</ASmdl3Not>
End of Settlement Model	</SttlmMdl>
Settlement Model	<SttlmMdl>
Settlement Model Number	<SttlmMdlNb>5</SttlmMdlNb>
AS Account Type	<ASAcctTp>AST</ASAcctTp>
AS Account BIC	<ASAcctBIC>ZYAJFRT0HA1</ASAcctBIC>
Guarantee Account BIC	<GrntyAcctBIC>ZYAJFRT0HG1</GrntyAcctBIC>
End of Settlement Model	</SttlmMdl>
Settlement Model	<SttlmMdl>

Settlement Model Number		<SttlmMdlNb>6I</SttlmMdlNb>
AS Account Type		<ASAcctTp>AST</ASAcctTp>
AS Account BIC		<ASAcctBIC>ZYAJFRT0HCN</ASAcctBIC>
Autocollateral Account BIC		<AutoCltrBIC>ZYAJFRT0HCO</AutoCltrBIC>
AS Model 6 LiquidityTransfer Notification option		<ASMDl6LTNot>N</ASMDl6LTNot>
End of Settlement Model		</SttlmMdl>
End of AS Information		</ASInf>
End of AS		</AS>
End of BusinessReport		</BizRpt>
End of Message Type		</ReturnAS>
End of SSP Proprietary Data		</SspPrtryDt>
End of Proprietary Data		</Data>
End of Proprietary Data		</PrtryData>
End proprietary message		</PrtryMsg>

ReturnAS_SD_2

Scope: Error message Response to an XML GetAS request for an irrelevant period search

Name Proprietary message	<PrtryMsg>
Message Header	<MsgHdr>
Message Identification	<MsgId>RETURNABC123</MsgId>
End of Message Header	</MsgHdr>
Related	<Rltd>
Reference	<Ref>ABC123</Ref>
End of Related	</Rltd>
Proprietary Data	<PrtryData>
Proprietary Data type	<Tp>ReturnAS</Tp>
Proprietary Data	<Data>
SSP Proprietary Data	<SspPrtryDt>
Message Type	<ReturnAS>
OperationalError	<OprlErr>
Error handling	<Err>
Proprietary error code	<Prtry>S100</Prtry>
End error handling	</Err>
Description	<Desc>No data available for selected criteria - No AS data found</Desc>
End of Operational Error	</OprlErr>
End of Message Type	</ReturnAS>
End of SSP Proprietary Data	</SspPrtryDt>
End of Proprietary Data	</Data>
End of Proprietary Data	</PrtryData>
End proprietary message	</PrtryMsg>

6. 5.33 ReturnASSettBank

SSP Proprietary Messages

ReturnASSettBank_SD

Scope: This is the response to the XML Request : GetASSettBank

<camt.998.001.xx>

Structure:

Name Proprietary message	<PrtryMsg>
Message Header	<MsgHdr>
Message Identification	<MsgId></MsgId>
End of Message Header	</MsgHdr>
Related	<Rltd>
Reference	<Ref></Ref>
End of Related	</Rltd>
Proprietary Data	<PrtryData>
Proprietary Data type	<Tp>ReturnASSettBank</Tp>
Proprietary Data	<Data>
SSP Proprietary Data	<SspPrtryDt>
Message Type	<ReturnASSettlBank>
Choice amongst	<xorBizRptOprlErr>
BusinessReport	<BizRpt>
AS Settlement Bank	<ASStlmBk>
AS Information	<ASInf>
AS Name	<ASNm></ASNm>
AS BIC	<ASBIC></ASBIC>
CB Responsible	<Ctry></Ctry>
AS Type	<ASTp></ASTp>
End of AS Information	</ASInf>
List of Settlement Bank	<ListStlmBk>
Settlement Bank Information	<StlmBkInf>
Record Status Information	<RecStsInf>
Planned Change	<PlndChng></PlndChng>
Record Status	<RecSts></RecSts>
Modification Date	<ModDt></ModDt>
End Date	<EndDt></EndDt>
End of Record Status Information	</RecStsInf>
Settlement Bank Details	<StlmBkDtl>
Settlement Bank BIC	<StlmBkBIC></StlmBkBIC>
Settlement Bank Name	<StlmBkNm></StlmBkNm>
Settlement Bank Account Number	<StlmBkAcctNb></StlmBkAcctNb>
Settlement Bank Account Type	<StlmBkAcctTp></StlmBkAcctTp>
End of Settlement Bank Details	</StlmBkDtl>
End of Settlement Bank Information	</StlmBkInf>
End of List of Settlement Bank	</ListStlmBk>
End of AS Settlement Bank	</ASStlmBk>
End of BusinessReport	</BizRpt>
OperationalError	<OprlErr>
Error handling	<Err>
Proprietary error code	<Prtry></Prtry>
End error handling	</Err>
Description	<Desc></Desc>

End of Operational Error							</OpriErr>
End of choice							</xorBizRptOpriErr>
End of Message Type							</ReturnASSettlBank>
End of SSP Proprietary Data							</SspPrtryDt>
End of Proprietary Data							</Data>
End of Proprietary Data							</PrtryData>
End proprietary message							</PrtryMsg>

Attributes:

name of attribute	format	short description	description
<PrtryMsg>		Name Proprietary message Mandatory	Validation: [1..1]
<MsgHdr>		Message Header Mandatory	Set of characteristics specific to the message Validation: [1..1]
<MsgId>-</MsgId>	35x	Message Identification Mandatory	Message Identification Validation: [1..1]
</MsgHdr>		End of Message Header Mandatory	Validation: [1..1]
<Rltd>		Related Optional	References a previously received message. Validation: [0..1]
<Ref>-</Ref>	35x	Reference Mandatory	Unique and unambiguous reference Validation: [1..1]
</Rltd>		End of Related Optional	End of Related Validation: [0..1]
<PrtryData>		Proprietary Data Mandatory	Proprietary Data Validation: [1..1]
<Tp>-</Tp>	35x	Proprietary Data type Mandatory	Proprietary Data type defines the Type of the free format XML Validation: [1..1]
<Data>		Proprietary Data Mandatory	Proprietary data content Validation: [1..1]
<SspPrtryDt>		SSP Proprietary Data Mandatory	Root element for all SSP proprietary data Validation: [1..1]
<ReturnASSettlBank>	35x	Message Type Mandatory	Message Type Validation: [1..1]
xorBizRptOpriErr		Choice amongst Optional	Choice amongst xorBizRptOpriErr (Type: xor) Validation:

name of attribute	format	short description	description
<BizRpt>		BusinessReport	BusinessReport Rule rationale: The message will contain either the information matching the search criteria of the related Get message or an error indication. Rule description: If BusinessReport is present then OperationalError is not allowed. If BusinessReport is not present, then OperationalError is mandatory.
		Mandatory	Validation: [1..1]
<ASStlmBk>		AS Settlement Bank	AS Settlement Bank
		Mandatory	Validation: [1..1]
<ASInf>		AS Information	AS Information
		Mandatory	Validation: [1..1]
<ASNm>-</ASNm>	35x	AS Name	This is the name of the Ancillary System.
		Mandatory	Validation: [1..1]
<ASBIC>-</ASBIC>	11x	AS BIC	A code allocated to a financial institution by a Registration Authority under an international identification scheme, as described in the latest edition of the international standard ISO 9362 "Banking - Banking telecommunication messages - Bank identifier codes". In this case, this is the BIC 11 of the Ancillary System.
		Mandatory	Validation: [1..1]
<Ctry>-</Ctry>	21c	CB Responsible	Country Code of the Responsible CB.
		Mandatory	Validation: [1..1]
<ASTp>-</ASTp>	31a	AS Type	List of values : "RTL" for Retail Payment System "LVP" for Large Value Payment System "FEX" for Foreign Exchange System "MMK" for Money Market System "CCP" for Clearing House "SSG" for Securities Settlement System, real-time "SSF" for Securities Settlement System, interfaced "MPO" for "CB using ASI for monetary policy operations"
		Mandatory	Validation: [1..1]
</ASInf>		End of AS Information	End of AS Information
		Mandatory	Validation: [1..1]
<ListStlmBk>		List of Settlement Bank	List of Settlement Bank
		Mandatory	Validation: [1..1]

name of attribute	format	short description	description
<StlmBkInf>		Settlement Bank Information Mandatory	Settlement Bank Information Validation: [1..n]
<RecStsInf>		Record Status Information Mandatory	Record Status Information Validation: [1..1]
<PlnndChng>-</PlnndChng>	1!a	Planned Change Mandatory	Information on record regarding the presence of a future record. Values may be : "N" if no future record is present "D" if the record will be deleted "M" if a future record exists Note : the Planned Change flag has been added in order to help users when displaying an active record. Actually, for an active record with an End Date different from '9999-12-31', it is not possible to know whether the related record will be deleted (when the system reach the End Date) or if a future record exists and will be active, as a substitute for the active one. The use of the Planned Change flag is made to have information on the future of an active record. Validation: [1..1]
<RecSts>-</RecSts>	2x	Record Status Mandatory	Status of the record. List of values : "AC" for Active "FU" for Future "RE" for Rejected "AR" for Archived "AF" for Archived Future "IC" for In Change "DV" for Delivery (Technical) "ID" for In Deletion (Technical) For more information on status management, refer to the ICM UserHandBook. Validation: [1..1]
<ModDt>-</ModDt>	ISODate	Modification Date Mandatory	Date within a particular calendar year represented by YYYY-MM-DD (ISO 8601). This is the modification date of the related record. If the record has not been modified since its activation, the modification date is equal to the first activation date. Validation: [1..1]
<EndDt>-</EndDt>	ISODate	End Date Mandatory	Date within a particular calendar year represented by YYYY-MM-DD (ISO 8601). This is the end date of the related record. Value is equal to '9999-12-31' if no modification or deletion are foreseen for this record. Otherwise, the End Date takes the value of the modification date or date of the deletion. Validation: [1..1]
</RecStsInf>		End of Record Status Information	End of Record Status Information

name of attribute	format	short description	description
		Mandatory	Validation: [1..1]
<SttlmBkDtl>		Settlement Bank Details	Settlement Bank Details
		Mandatory	Validation: [1..1]
<SttlmBkBIC>-</SttlmBkBIC>	4!a2!a2!c[3!c]	Settlement Bank BIC	A code allocated to a financial institution by a Registration Authority under an international identification scheme, as described in the latest edition of the international standard ISO 9362 "Banking - Banking telecommunication messages - Bank identifier codes". This is the BIC 11 of the Settlement Bank (BIC Participant).
		Mandatory	Validation: [1..1]
<SttlmBkNm>-</SttlmBkNm>	35x	Settlement Bank Name	Specifies a character string with a maximum length of 35 characters. This is the name of the Settlement Bank.
		Mandatory	Validation: [1..1]
<SttlmBkAcctNb>-</SttlmBkAcctNb>	2!c32x	Settlement Bank Account Number	Account Number. Length 34 characters (first two digit is the country code of the responsible CB).
		Optional	Validation: [0..1]
<SttlmBkAcctTp>-</SttlmBkAcctTp>	4x	Settlement Bank Account Type	List of values : "RTGS" for RTGS Account "SUB" for Sub Account
		Mandatory	Validation: [1..1]
</SttlmBkDtl>		End of Settlement Bank Details	End of Settlement Bank Details
		Mandatory	Validation: [1..1]
</SttlmBkInf>		End of Settlement Bank Information	End of Settlement Bank Information
		Mandatory	Validation: [1..n]
</ListSttlmBk>		End of List of Settlement Bank	List of Settlement Bank
		Mandatory	Validation: [1..1]
</ASSttlmBk>		End of AS Settlement Bank	End of AS Settlement Bank
		Mandatory	Validation: [1..1]
</BizRpt>		End of BusinessReport	End of BusinessReport
		Mandatory	Validation: [1..1]
<OprlErr>		OperationalError	Rule rationale: The message will contain either the information matching the search criteria of the related

name of attribute	format	short description	description
			Get message or an error indication. Rule description: If BusinessReport is present then OperationalError is not allowed. If BusinessReport is not present, then OperationalError is mandatory. Separate Specification see UDFS books regarding error codes
		Mandatory	Validation: [1..1]
<Err>		Error handling Mandatory	Validation: [1..1]
<Prtry>-</Prtry>	4x	Proprietary error code Mandatory	Specification of the error, in free format. Validation: [1..1]
</Err>		End error handling Mandatory	Validation: [1..1]
<Desc>-</Desc>	140x	Description Optional	Specification of the error, in free format. Validation: [0..1]
</OprlErr>		End of Operational Error Mandatory	End of Operational Error Validation: [1..1]
/xorBizRptOprlErr		End of choice Optional	End of Choice Validation:
</ReturnASSettlBank>		End of Message Type Mandatory	End of Message Type Validation: [1..1]
</SspPrtryDt>		End of SSP Proprietary Data Mandatory	End of Root element for all SSP proprietary data Validation: [1..1]
</Data>		End of Proprietary Data Mandatory	Validation: [1..1]
</PrtryData>		End of Proprietary Data Mandatory	End of Proprietary Data Validation: [1..1]
</PrtryMsg>		End proprietary message Mandatory	Validation:

Error Codes:

ReturnASSettBank_SD_1

Scope: Response to the XML GetASSettBank request

Name Proprietary message	<PrtryMsg>
Message Header	<MsgHdr>
Message Identification	<Msgld>13587813400871443052472</Msgld>
End of Message Header	</MsgHdr>
Related	<Rltd>
Reference	<Ref>GETASSB20130122</Ref>
End of Related	</Rltd>
Proprietary Data	<PrtryData>
Proprietary Data type	<Tp>ReturnASSettBank</Tp>
Proprietary Data	<Data>
SSP Proprietary Data	<SspPrtryDt>
Message Type	<ReturnASSettlBank>
BusinessReport	<BizRpt>
AS Settlement Bank	<ASStlmBk>
AS Information	<ASInf>
AS Name	<ASNm>ZYAJFRT0BAA</ASNm>
AS BIC	<ASBIC>ZYAJFRT0BAA</ASBIC>
CB Responsible	<Ctry>BE</Ctry>
AS Type	<ASTp>RTL</ASTp>
End of AS Information	</ASInf>
List of Settlement Bank	<ListStlmBk>
Settlement Bank Information	<StlmBkInf>
Record Status Information	<RecStsInf>
Planned Change	<PlndChng>N</PlndChng>
Record Status	<RecSts>AC</RecSts>
Modification Date	<ModDt>2011-09-28</ModDt>
End Date	<EndDt>9999-12-31</EndDt>
End of Record Status Information	</RecStsInf>
Settlement Bank Details	<StlmBkDtl>
Settlement Bank BIC	<StlmBkBIC>ZYAJFRT0BS2</StlmBkBIC>
Settlement Bank Name	<StlmBkNm>ASI Settlement Bank ZYAJFRT0BS2</StlmBkNm>
Settlement Bank Account Number	<StlmBkAcctNb>BEPINZYAJFRT0BS2000000 000001005</StlmBkAcctNb>
Settlement Bank Account Type	<StlmBkAcctTp>RTGS</StlmBkAcctTp>
End of Settlement Bank Details	</StlmBkDtl>
End of Settlement Bank Information	</StlmBkInf>
End of List of Settlement Bank	</ListStlmBk>
End of AS Settlement Bank	</ASStlmBk>
End of BusinessReport	</BizRpt>
End of Message Type	</ReturnASSettlBank>
End of SSP Proprietary Data	</SspPrtryDt>
End of Proprietary Data	</Data>
End of Proprietary Data	</PrtryData>
End proprietary message	</PrtryMsg>

ReturnASSettBank_SD_2

Scope: Error response to the XML GetASSettBank request

Name Proprietary message	<PrtryMsg>
Message Header	<MsgHdr>
Message Identification	<MsgId>13587813400871443052473</MsgId>
End of Message Header	</MsgHdr>
Related	<Rltd>
Reference	<Ref>GETSBWB2</Ref>
End of Related	</Rltd>
Proprietary Data	<PrtryData>
Proprietary Data type	<Tp>ReturnASSettBank</Tp>
Proprietary Data	<Data>
SSP Proprietary Data	<SspPrtryDt>
Message Type	<ReturnASSettBank>
OperationalError	<OpriErr>
Error handling	<Err>
Proprietary error code	<Prtry>S600</Prtry>
End error handling	</Err>
Description	<Desc>The requested creation is not possible - Ancillary System entered does not exist</Desc>
End of Operational Error	</OpriErr>
End of Message Type	</ReturnASSettBank>
End of SSP Proprietary Data	</SspPrtryDt>
End of Proprietary Data	</Data>
End of Proprietary Data	</PrtryData>
End proprietary message	</PrtryMsg>

6. 5.34 ReturnCalendar

SSP Proprietary Messages

ReturnCalendar_SD

Scope: This is the response to the XML request : GetCalendar

<camt.998.001.xx>

Structure:

Name Proprietary message	<PrtryMsg>
Message Header	<MsgHdr>
Message Identification	<MsgId></MsgId>
End of Message Header	</MsgHdr>
Related	<Rltd>
Reference	<Ref></Ref>
End of Related	</Rltd>
Proprietary Data	<PrtryData>
Proprietary Data type	<Tp>ReturnCalendar</Tp>
Proprietary Data	<Data>
SSP Proprietary Data	<SspPrtryDt>
Message Type	<ReturnCalendar>
Choice amongst	<xorBizRptOprlErr>
BusinessReport	<BizRpt>
Calendar	<Clnr>
Calendar Information	<ClnrInf>
Date	<Dt></Dt>
Target Day Status	<Sts></Sts>
Is Start Of Maintenance Period	<StartPrd></StartPrd>
End of Calendar Information	</ClnrInf>
End of Calendar	</Clnr>
End of BusinessReport	</BizRpt>
OperationalError	<OprlErr>
Error handling	<Err>
Proprietary error code	<Prtry></Prtry>
End error handling	</Err>
Description	<Desc></Desc>
End of Operational Error	</OprlErr>
End of choice	</xorBizRptOprlErr>
End of Message Type	</ReturnCalendar>
End of SSP Proprietary Data	</SspPrtryDt>
End of Proprietary Data	</Data>
End of Proprietary Data	</PrtryData>
End proprietary message	</PrtryMsg>

Attributes:

name of attribute	format	short description	description
<PrtryMsg>		Name Proprietary message Mandatory	Validation: [1..1]
<MsgHdr>		Message Header Mandatory	Set of characteristics specific to the message Validation: [1..1]
<MsgId></MsgId>	35x	Message Identification Mandatory	Message Identification Validation: [1..1]
</MsgHdr>		End of Message Header Mandatory	Validation: [1..1]
<Rltd>		Related Optional	References a previously received message. Validation: [0..1]
<Ref></Ref>	35x	Reference Mandatory	Unique and unambiguous reference Validation: [1..1]
</Rltd>		End of Related Optional	End of Related Validation: [0..1]
<PrtryData>		Proprietary Data Mandatory	Proprietary Data Validation: [1..1]
<Tp></Tp>	35x	Proprietary Data type Mandatory	Proprietary Data type defines the Type of the free format XML Validation: [1..1]
<Data>		Proprietary Data Mandatory	Proprietary data content Validation: [1..1]
<SspPrtryDt>		SSP Proprietary Data Mandatory	Root element for all SSP proprietary data Validation: [1..1]
<ReturnCalendar>		Message Type Mandatory	Message Type for Static Data Validation: [1..1]
xorBizRptOpriErr		Choice amongst	Choice amongst xorBizRptOpriErr (Type: xor)

name of attribute	format	short description	description
		Optional	Validation:
<BizRpt>		BusinessReport	BusinessReport Rule rationale: The message will contain either the information matching the search criteria of the related Get message or an error indication. Rule description: If BusinessReport is present then OperationalError is not allowed. If BusinessReport is not present, then OperationalError is mandatory.
		Mandatory	Validation: [1..1]
<Clnr>		Calendar	Calendar
		Mandatory	Validation: [1..n]
<ClnrInf>		Calendar Information	Calendar Information
		Mandatory	Validation: [1..n]
<Dt>-</Dt>	ISO-Date	Date	Date within a particular calendar year represented by YYYY-MM-DD (ISO 8601).
		Mandatory	Validation: [1..1]
<Sts>-</Sts>	6x	Target Day Status	Status of Day within the Target calendar. Value may be 'OPEN' or 'CLOSED'.
		Mandatory	Validation: [1..1]
<StartPrd>-</StartPrd>	1!a	Is Start Of Maintenance Period	A flag with two values : 'Y' or 'N'. Indicates whether the related date is the first date for maintenance period.
		Mandatory	Validation: [1..1]
</ClnrInf>		End of Calendar Information	End of Calendar Information
		Mandatory	Validation: [1..n]
</Clnr>		End of Calendar	End of Calendar
		Mandatory	Validation: [1..n]
</BizRpt>		End of BusinessReport	End of BusinessReport
		Mandatory	Validation: [1..1]
<OpriErr>		OperationalError	Rule rationale: The message will contain either the information matching the search criteria of the related Get message or an error indication. Rule description: If BusinessReport is present then OperationalError is not allowed. If BusinessReport is not present, then OperationalError is mandatory. Separate Specification see UDFS books regarding error codes

name of attribute	format	short description	description
		Mandatory	Validation: [1..1]
<Err>		Error handling	
		Mandatory	Validation: [1..1]
<Prtry>-</Prtry>	4x	Proprietary error code	Specification of the error, in free format.
		Mandatory	Validation: [1..1]
</Err>		End error handling	
		Mandatory	Validation: [1..1]
<Desc>-</Desc>	140x	Description	Specification of the error, in free format.
		Optional	Validation: [0..1]
</OprlErr>		End of Operational Error	End of Operational Error
		Mandatory	Validation: [1..1]
/xorBizRptOprlErr		End of choice	End of Choice
		Optional	Validation:
</ReturnCalendar>		End of Message Type	End of Message Type for Static Data
		Mandatory	Validation: [1..1]
</SspPrtryDt>		End of SSP Proprietary Data	End of Root element for all SSP proprietary data
		Mandatory	Validation: [1..1]
</Data>		End of Proprietary Data	
		Mandatory	Validation: [1..1]
</PrtryData>		End of Proprietary Data	End of Proprietary Data
		Mandatory	Validation: [1..1]
</PrtryMsg>		End proprietary message	
		Mandatory	Validation:

Error Codes:

ReturnCalendar_SD_1

Scope: Response to the XML GetCalendar request for the year 2013

Name Proprietary message	<PrtryMsg>
Message Header	<MsgHdr>
Message Identification	<MsgId>13587725733221762584282</MsgId>
End of Message Header	</MsgHdr>
Related	<Rltd>
Reference	<Ref>GETCALENDAR2013</Ref>
End of Related	</Rltd>
Proprietary Data	<PrtryData>
Proprietary Data type	<Tp>ReturnCalendar</Tp>
Proprietary Data	<Data>
SSP Proprietary Data	<SspPrtryDt>
Message Type	<ReturnCalendar>
BusinessReport	<BizRpt>
Calendar	<Cindr>
Calendar Information	<CindrInf>
Date	<Dt>2013-01-01</Dt>
Target Day Status	<Sts>CLOSED</Sts>
Is Start Of Maintenance Period	<StartPrd>N<StartPrd>
End of Calendar Information	</CindrInf>
Calendar Information	<CindrInf>
Date	<Dt>2013-01-02</Dt>
Target Day Status	<Sts>OPEN</Sts>
Is Start Of Maintenance Period	<StartPrd>N<StartPrd>
End of Calendar Information	</CindrInf>
Calendar Information	<CindrInf>
Date	<Dt>2013-01-03</Dt>
Target Day Status	<Sts>OPEN</Sts>
Is Start Of Maintenance Period	<StartPrd>N<StartPrd>
End of Calendar Information	</CindrInf>
Calendar Information	<CindrInf>
Date	<Dt>2013-01-04</Dt>
Target Day Status	<Sts>OPEN</Sts>
Is Start Of Maintenance Period	<StartPrd>N<StartPrd>
End of Calendar Information	</CindrInf>
Calendar Information	<CindrInf>
Date	<Dt>2013-01-05</Dt>
Target Day Status	<Sts>CLOSED</Sts>
Is Start Of Maintenance Period	<StartPrd>N<StartPrd>
End of Calendar Information	</CindrInf>
Calendar Information	<CindrInf>
Date	<Dt>2013-12-27</Dt>
Target Day Status	<Sts>CLOSED</Sts>
Is Start Of Maintenance Period	<StartPrd>N<StartPrd>
End of Calendar Information	</CindrInf>
Calendar Information	<CindrInf>
Date	<Dt>2013-12-28</Dt>
Target Day Status	<Sts>CLOSED</Sts>
Is Start Of Maintenance Period	<StartPrd>N<StartPrd>
End of Calendar Information	</CindrInf>

Calendar Information	<ClnDrInf>
Date	<Dt>2013-12-29</Dt>
Target Day Status	<Sts>CLOSED</Sts>
Is Start Of Maintenance Period	<StartPrd>N<StartPrd>
End of Calendar Information	</ClnDrInf>
Calendar Information	<ClnDrInf>
Date	<Dt>2013-12-30</Dt>
Target Day Status	<Sts>CLOSED</Sts>
Is Start Of Maintenance Period	<StartPrd>N<StartPrd>
End of Calendar Information	</ClnDrInf>
Calendar Information	<ClnDrInf>
Date	<Dt>2013-12-31</Dt>
Target Day Status	<Sts>CLOSED</Sts>
Is Start Of Maintenance Period	<StartPrd>N<StartPrd>
End of Calendar Information	</ClnDrInf>
End of Calendar	</ClnDr>
End of BusinessReport	</BizRpt>
End of Message Type	</ReturnCalendar>
End of SSP Proprietary Data	</SspPrtryDt>
End of Proprietary Data	</Data>
End of Proprietary Data	</PrtryData>
End proprietary message	</PrtryMsg>

ReturnCalendar_SD_2

Scope: Error message Response to the XML GetCalendar request for the non-existing year 2017(in TARGET2)

Name Proprietary message	<PrtryMsg>
Message Header	<MsgHdr>
Message Identification	<MsgId>1358844769640232218903</MsgId>
End of Message Header	</MsgHdr>
Related	<Rltd>
Reference	<Ref>GETCALENDAR2017</Ref>
End of Related	</Rltd>
Proprietary Data	<PrtryData>
Proprietary Data type	<Tp>ReturnCalendar</Tp>
Proprietary Data	<Data>
SSP Proprietary Data	<SspPrtryDt>
Message Type	<ReturnCalendar>
OperationalError	<OprlErr>
Error handling	<Err>
Proprietary error code	<Prtry>S100</Prtry>
End error handling	</Err>
Description	<Desc>No data available for selected criteria - no calendar data found.</Desc>
End of Operational Error	</OprlErr>
End of Message Type	</ReturnCalendar>
End of SSP Proprietary Data	</SspPrtryDt>
End of Proprietary Data	</Data>
End of Proprietary Data	</PrtryData>
End proprietary message	</PrtryMsg>

6. 5.35 ReturnCB

SSP Proprietary Messages

ReturnCB_SD

Scope: This is the response to the XML request : GetCB

<camt.998.001.xx>

Structure:

Name Proprietary message	<PrtryMsg>
Message Header	<MsgHdr>
Message Identification	<MsgId></MsgId>
End of Message Header	</MsgHdr>
Related	<Rltd>
Reference	<Ref></Ref>
End of Related	</Rltd>
Proprietary Data	<PrtryData>
Proprietary Data type	<Tp>ReturnCB</Tp>
Proprietary Data	<Data>
SSP Proprietary Data	<SspPrtryDt>
Message Type	<ReturnCB>
Choice amongst	<xorBizRptOprlErr>
BusinessReport	<BizRpt>
CB	<CntrlBk>
Record Status Information	<RecStsInf>
Planned Change	<PlndChng></PlndChng>
Record Status	<RecSts></RecSts>
First Activation Date	<FrstDt></FrstDt>
Modification Date	<ModDt></ModDt>
End Date	<EndDt></EndDt>
End of Record Status Information	</RecStsInf>
CB Information	<CntrlBkInf>
CB Name	<CntrlBkNm></CntrlBkNm>
BIC CB	<BICCntrlBk></BICCntrlBk>
CB Responsible	<Ctry></Ctry>
City of the CB	<CntrlBkCty></CntrlBkCty>
Eurosystem Flag	<EurSysFlag></EurSysFlag>
Calculation Periodicity for HAM	<ClctnPrdctyHam></ClctnPrdctyHam>
Collateral Manager BIC	<CltrlBIC></CltrlBIC>
Collateral Manager Desc	<CltrlDesc></CltrlDesc>
Service for FileAct in Push Mode (Collateral Manager only)	<CltrlSvc></CltrlSvc>
DN for FileAct in Push Mode (Collateral Manager only)	<CltrlDN></CltrlDN>
Packed File Delivery (Collateral Manager)	<PckdFileCltrl></PckdFileCltrl>
DN for FileAct in Push Mode (PHA)	<PHADN></PHADN>
Service for PHA Interface	<PHASvc></PHASvc>
Service for FileAct in Push Mode	<Svc></Svc>
DN for Push Mode	<DN></DN>
Packed File Delivery	<PckdFile></PckdFile>
ECB Account BIC	<ECBAcctBIC></ECBAcctBIC>
ECB Mirror Account BIC	<ECBMrAcctBIC></ECBMrAcctBIC>
CB BIC to be billed for T2S invoices	<CBBldT2SInv></CBBldT2SInv>
T2S CB BIC	<T2SCBBIC></T2SCBBIC>

Migration Flag	<MigtnFlag></MigtnFlag>
Ham Flag	<HamFlag></HamFlag>
RM Flag	<RMFlag></RMFlag>
SFM Flag	<SFMFlag></SFMFlag>
CRAKS 1 Flag	<CRAKS1Flag></CRAKS1Flag>
CRAKS 3 Flag	<CRAKS3Flag></CRAKS3Flag>
CRISP Flag	<CRISPFlag></CRISPFlag>
CRISP - Invoice Flag	<CRISPInvceFlag></CRISPInvceFlag>
Country Code Service Provider 1	<CCSP1></CCSP1>
Country Code Service Provider 2	<CCSP2></CCSP2>
Country Code Service Provider 3	<CCSP3></CCSP3>
Contingency BIC	<CtgncyBIC></CtgncyBIC>
Interlinking BIC	<IntrlkngBIC></IntrlkngBIC>
TARGET 1 Service Code	<T1SvcCd></T1SvcCd>
Maximum Amount Allowed for SF	<MaxForStgFclts></MaxForStgFclts>
End of CB Information	</CntrlBkInf>
End of CB	</CntrlBk>
End of BusinessReport	</BizRpt>
OperationalError	<OprlErr>
Error handling	<Err>
Proprietary error code	<Prtry></Prtry>
End error handling	</Err>
Description	<Desc></Desc>
End of Operational Error	</OprlErr>
End of choice	</xorBizRptOprlErr>
End of Message Type	</ReturnCB>
End of SSP Proprietary Data	</SspPrtryDt>
End of Proprietary Data	</Data>
End of Proprietary Data	</PrtryData>
End proprietary message	</PrtryMsg>

Attributes:

name of attribute	format	short description	description
<PrtryMsg>		Name Proprietary message Mandatory	Validation: [1..1]
<MsgHdr>		Message Header Mandatory	Set of characteristics specific to the message Validation: [1..1]
<MsgId></MsgId>	35x	Message Identification Mandatory	Message Identification Validation: [1..1]
</MsgHdr>		End of Message Header Mandatory	Validation: [1..1]
<Rltd>		Related Optional	References a previously received message. Validation: [0..1]
<Ref></Ref>	35x	Reference Mandatory	Unique and unambiguous reference Validation: [1..1]
</Rltd>		End of Related Optional	End of Related Validation: [0..1]
<PrtryData>		Proprietary Data Mandatory	Proprietary Data Validation: [1..1]
<Tp></Tp>	35x	Proprietary Data type Mandatory	Proprietary Data type defines the Type of the free format XML Validation: [1..1]
<Data>		Proprietary Data Mandatory	Proprietary data content Validation: [1..1]
<SspPrtryDt>		SSP Proprietary Data Mandatory	Root element for all SSP proprietary data Validation: [1..1]
<ReturnCB>		Message Type Mandatory	Message Type for Static Data Validation: [1..1]
xorBizRptOpriErr		Choice amongst Optional	Choice amongst xorBizRptOpriErr (Type: xor) Validation:

name of attribute	format	short description	description
<BizRpt>		BusinessReport	<p>BusinessReport</p> <p>Rule rationale: The message will contain either the information matching the search criteria of the related Get message or an error indication.</p> <p>Rule description: If BusinessReport is present then OperationalError is not allowed. If BusinessReport is not present, then OperationalError is mandatory.</p> <p>Mandatory</p> <p>Validation: [1..1]</p>
<CntrlBk>		CB	<p>Central Bank</p> <p>Mandatory</p> <p>Validation: [1..n]</p>
<RecStsInf>		Record Status Information	<p>Record Status Information</p> <p>Mandatory</p> <p>Validation: [1..1]</p>
<PlnndChng>-</PlnndChng>	1!a	Planned Change	<p>Information on record regarding the presence of a future record. Values may be :</p> <p>"N" if no future record is present "D" if the record will be deleted "M" if a future record exists</p> <p>Note : the Planned Change flag has been added in order to help users when displaying an active record. Actually, for an active record with an End Date different from '9999-12-31', it is not possible to know whether the related record will be deleted (when the system reach the End Date) or if a future record exists and will be active, as a substitute for the active one.</p> <p>The use of the Planned Change flag is made to have information on the future of an active record.</p> <p>Mandatory</p> <p>Validation: [1..1]</p>
<RecSts>-</RecSts>	2x	Record Status	<p>Status of the record. List of values :</p> <p>"AC" for Active "FU" for Future "RE" for Rejected "AR" for Archived "AF" for Archived Future "IC" for In Change "DV" for Delivery (Technical) "ID" for In Deletion (Technical)</p> <p>For more information on status management, refer to the ICM UserHandBook.</p> <p>Mandatory</p> <p>Validation: [1..1]</p>
<FrstDt>-</FrstDt>	ISODate	First Activation Date	<p>Date within a particular calendar year represented by YYYY-MM-DD (ISO 8601). This date represents the first activation date of a functional item, such as a Participant. It is different from the modification date, which is the last date when a modification occurred.</p> <p>Mandatory</p> <p>Validation: [1..1]</p>

name of attribute	format	short description	description
<ModDt>-</ModDt>	ISODate	Modification Date	Date within a particular calendar year represented by YYYY-MM-DD (ISO 8601). This is the modification date of the related record. If the record has not been modified since its activation, the modification date is equal to the first activation date. Optional Validation: [0..1]
<EndDt>-</EndDt>	ISODate	End Date	Date within a particular calendar year represented by YYYY-MM-DD (ISO 8601). This is the end date of the related record. Value is equal to '9999-12-31' if no modification or deletion are foreseen for this record. Otherwise, the End Date takes the value of the modification date or date of the deletion. Optional Validation: [0..1]
</RecStsInf>		End of Record Status Information Mandatory	End of Record Status Information Validation: [1..1]
<CntrlBkInf>		CB Information Mandatory	CB Information Validation: [1..1]
<CntrlBkNm>-</CntrlBkNm>	35x	CB Name Mandatory	Name of the Central Bank Validation: [1..1]
<BICCntrlBk>-</BICCntrlBk>	11x	BIC CB Mandatory	A code allocated to a financial institution by a Registration Authority under an international identification scheme, as described in the latest edition of the international standard ISO 9362 "Banking - Banking telecommunication messages - Bank identifier codes". In this case, this is the BIC 11 of the Central Bank. Validation: [1..1]
<Ctry>-</Ctry>	2!c	CB Responsible Mandatory	Country Code of the Responsible CB. Validation: [1..1]
<CntrlBkCty>-</CntrlBkCty>	35x	City of the CB Mandatory	City of the Central Bank. Max 35x. Validation: [1..1]
<EurSysFlag>-</EurSysFlag>	1!a	Eurosystem Flag Mandatory	A flag with two value : 'Y' or 'N'. This flag is set to 'Y' for all Central Bank using the Euro currency. Otherwise, it is set to 'N' for the other CB. Validation: [1..1]
<ClctnPrdctyHam>-</ClctnPrdctyHam>	2!n	Calculation Periodicity for HAM Mandatory	2 characters (number of month) Validation:

name of attribute	format	short description	description
			[1..1]
<CltrlBIC>-</CltrlBIC>	4!a2!a2!c[3!c]	Collateral Manager BIC	<p>A code allocated to a financial institution by a Registration Authority under an international identification scheme, as described in the latest edition of the international standard ISO 9362 "Banking - Banking telecommunication messages - Bank identifier codes".</p> <p>In this case, this is the BIC 11 of the collateral Manager.</p> <p>Validation: [0..1]</p>
<CltrlDesc>-</CltrlDesc>	35x	Collateral Manager Desc	<p>Specifies a character string with a maximum length of 35 characters. Description of the Collateral Manager.</p> <p>Validation: [0..1]</p>
<CltrlSvc>-</CltrlSvc>	30x	Service for FileAct in Push Mode (Collateral Manager only)	<p>This is the SWIFT Service used by the Collateral Manager in order to receive information from the SSP (Push Mode).</p> <p>Validation: [0..1]</p>
<CltrlDN>-</CltrlDN>	100x	DN for FileAct in Push Mode (Collateral Manager only)	<p>This is the SWIFT Distinguished Name used by the Collateral Manager in order to receive information from the SSP (Push mode).</p> <p>Validation: [0..1]</p>
<PckdFileCltrl>-</PckdFileCltrl>	1!a	Packed File Delivery (Collateral Manager)	<p>A flag with two values : 'Y' or 'N'. This flag indicates whether the Collateral Manager wants to receive all SWIFTNet messages sent by the SSP in packed mode.</p> <p>Validation: [0..1]</p>
<PHADN>-</PHADN>	100x	DN for FileAct in Push Mode (PHA)	<p>This is the SWIFT Distinguished Name used by the Proprietary Home Account in order to receive information from the SSP (Push Mode)</p> <p>Validation: [0..1]</p>
<PHASvc>-</PHASvc>	30x	Service for PHA Interface	<p>This is the SWIFT Service used by the CB for PHA interface</p> <p>Validation: [0..1]</p>
<Svc>-</Svc>	30x	Service for FileAct in Push Mode	<p>Service (for push mode functionalities)</p> <p>Validation: [0..1]</p>
<DN>-</DN>	100x	DN for Push Mode	<p>Distinguished Name, made of max 100 characters (for push mode functionalities).</p> <p>Validation: [0..1]</p>
<PckdFile>-</PckdFile>	1!a	Packed File Delivery	<p>A flag with two values : 'Y' or 'N' This flag indicates whether the participant wants to receive all SWIFTNet messages sent by the SSP in packed mode.</p>

name of attribute	format	short description	description
		Optional	Validation: [0..1]
<ECBAcctBIC>-</ECBAcctBIC>	4!a2!a2!c[3!c]	ECB Account BIC	A code allocated to a financial institution by a Registration Authority under an international identification scheme, as described in the latest edition of the international standard ISO 9362 "Banking - Banking telecommunication messages - Bank identifier codes". In this case, this is the BIC 11 identifying the ECB Account of the related Central Bank.
		Optional	Validation: [0..1]
<ECBMrAcctBIC>-</ECBMrAcctBIC>	4!a2!a2!c[3!c]	ECB Mirror Account BIC	A code allocated to a financial institution by a Registration Authority under an international identification scheme, as described in the latest edition of the international standard ISO 9362 "Banking - Banking telecommunication messages - Bank identifier codes". In this case, this is the BIC 11 identifying the ECB Mirror Account of the related Central Bank.
		Optional	Validation: [0..1]
<CBBldT2SInv>-</CBBldT2SInv>	4!a2!a2!c[3!c]	CB BIC to be billed for T2S invoices	CB BIC to be billed for T2S invoices. This is the BIC identifying the direct participant which will be billed of the T2S cash activity
		Optional	Validation: [0..1]
<T2SCBBIC>-</T2SCBBIC>	4!a2!a2!c[3!c]	T2S CB BIC	BIC identifying the CB in T2S
		Optional	Validation: [0..1]
<MigtnFlag>-</MigtnFlag>	1!a	Migration Flag	For CB only A flag with two values : 'Y' or 'N'
		Optional	Validation: [0..1]
<HamFlag>-</HamFlag>	1!a	Ham Flag	A flag with two values : 'Y' or 'N'
		Mandatory	Validation: [1..1]
<RMFlag>-</RMFlag>	1!a	RM Flag	A flag with two values : 'Y' or 'N'. This flag indicates whether the Central Bank is using the RM module.
		Mandatory	Validation: [1..1]
<SFMFlag>-</SFMFlag>	1!a	SFM Flag	A flag with two values : 'Y' or 'N'. This flag indicates whether the Central Bank is using the SF module.
		Mandatory	Validation: [1..1]
<CRAKS1Flag>-</CRAKS1Flag>	1!a	CRAKS 1 Flag	A flag with two values : 'Y' or 'N'. This flag indicates whether the Central Bank is using the CRAKS 1 module.

name of attribute	format	short description	description
		Mandatory	Validation: [1..1]
<CRAKS3Flag>-</CRAKS3Flag>	1!a	CRAKS 3 Flag	A flag with two values : 'Y' or 'N'. This flag indicates whether the Central Bank is using the CRAKS 3 module.
		Mandatory	Validation: [1..1]
<CRISPFlag>-</CRISPFlag>	1!a	CRISP Flag	A flag with two values : 'Y' or 'N'. This flag indicates whether the Central Bank is using the CRISP module.
		Mandatory	Validation: [1..1]
<CRISPInvceFlag>-</CRISPInvceFlag>	1!a	CRISP - Invoice Flag	A flag with two values : 'Y' or 'N'. This flag indicates whether the Central Bank is using the CRISP - Invoice module. Can be used only if the Central Bank has already opted for the CRISP module.
		Mandatory	Validation: [1..1]
<CCSP1>-</CCSP1>	2!c	Country Code Service Provider 1	ISO Country Code. 2 characters. This is the country code of the service provider 1 in case of contingency (for non migrated CB only).
		Optional	Validation: [0..1]
<CCSP2>-</CCSP2>	2!c	Country Code Service Provider 2	ISO Country Code. 2 characters. This is the country code of the service provider 2 in case of contingency (for non migrated CB only).
		Optional	Validation: [0..1]
<CCSP3>-</CCSP3>	2!c	Country Code Service Provider 3	ISO Country Code. 2 characters. This is the country code of the service provider 3 in case of contingency (for non migrated CB only).
		Optional	Validation: [0..1]
<CtgncyBIC>-</CtgncyBIC>	4!a2!a2!c[3!c]	Contingency BIC	A code allocated to a financial institution by a Registration Authority under an international identification scheme, as described in the latest edition of the international standard ISO 9362 "Banking - Banking telecommunication messages - Bank identifier codes". In this case, this is the BIC 11 identifying the Contingency Account of the participant. In this case, this is the Contingency BIC
		Optional	Validation: [0..1]
<IntrlkngBIC>-</IntrlkngBIC>	4!a2!a2!c[3!c]	Interlinking BIC	A code allocated to a financial institution by a Registration Authority under an international identification scheme, as described in the latest edition of the international standard ISO 9362 "Banking - Banking telecommunication messages - Bank identifier codes". In this case, this is the BIC 11 of the interlinking component of the related Central Bank.
		Optional	Validation:

name of attribute	format	short description	description
			[0..1]
<T1SvcCd>-</T1SvcCd>	3!a	TARGET 1 Service Code Optional	Made of 3 characters, amongst the list of Target 1 RTGS service code Validation: [0..1]
<MaxForStgFclts>-</MaxForStgFclts>	18!d	Maximum Amount Allowed for SF Optional	Amount, made of a maximum of 17 numbers and one digit (decimal coma) Validation: [0..1]
</CntrlBkInf>		End of CB Information Mandatory	End of CB Information Validation: [1..1]
</CntrlBk>		End of CB Mandatory	End of CB Validation: [1..n]
</BizRpt>		End of BusinessReport Mandatory	End of BusinessReport Validation: [1..1]
<OprlErr>		OperationalError Mandatory	Rule rationale: The message will contain either the information matching the search criteria of the related Get message or an error indication. Rule description: If BusinessReport is present then OperationalError is not allowed. If BusinessReport is not present, then OperationalError is mandatory. Separate Specification see UDFS books regarding error codes Validation: [1..1]
<Err>		Error handling Mandatory	Validation: [1..1]
<Prtry>-</Prtry>	4x	Proprietary error code Mandatory	Specification of the error, in free format. Validation: [1..1]
</Err>		End error handling Mandatory	Validation: [1..1]
<Desc>-</Desc>	140x	Description Optional	Specification of the error, in free format. Validation: [0..1]
</OprlErr>		End of Operational Error Mandatory	End of Operational Error Validation: [1..1]

name of attribute	format	short description	description
/xorBizRptOpriErr		End of choice	End of Choice
		Optional	Validation:
</ReturnCB>		End of Message Type	End of Message Type for Static Data
		Mandatory	Validation: [1..1]
</SspPrtryDt>		End of SSP Proprietary Data	End of Root element for all SSP proprietary data
		Mandatory	Validation: [1..1]
</Data>		End of Proprietary Data	
		Mandatory	Validation: [1..1]
</PrtryData>		End of Proprietary Data	End of Proprietary Data
		Mandatory	Validation: [1..1]
</PrtryMsg>		End proprietary message	
		Mandatory	Validation:

Error Codes:

ReturnCB_SD_1

Scope: Response to the XML GetCB

Name Proprietary message	<PrtryMsg>
Message Header	<MsgHdr>
Message Identification	<MsgId>RETURNABC123</MsgId>
End of Message Header	</MsgHdr>
Related	<Rltd>
Reference	<Ref>ABC123</Ref>
End of Related	</Rltd>
Proprietary Data	<PrtryData>
Proprietary Data type	<Tp>ReturnCB</Tp>
Proprietary Data	<Data>
SSP Proprietary Data	<SspPrtryDt>
Message Type	<ReturnCB>
BusinessReport	<BizRpt>
CB	<CntrlBk>
Record Status Information	<RecStsInf>
Planned Change	<PlnndChng>N</PlnndChng>
Record Status	<RecSts>AC</RecSts>
First Activation Date	<FrstDt>2008-06-12</FrstDt>
Modification Date	<ModDt>2011-12-01</ModDt>
End Date	<EndDt>9999-12-31</EndDt>
End of Record Status Information	</RecStsInf>
CB Information	<CntrlBkInf>
CB Name	<CntrlBkNm>FFR-CB-ES</CntrlBkNm>
BIC CB	<BICCntrlBk>ZYAJFRT0HCB</BICCntrlBk>
CB Responsible	<Ctry>ES</Ctry>
City of the CB	<CntrlBkCty>CITY ZYAJFRT0HCB</CntrlBkCty>
Eurosystem Flag	<EurSysFlag>Y</EurSysFlag>
Calculation Periodicity for HAM	<ClctnPrdctyHam>1</ClctnPrdctyHam>
Collateral Manager BIC	<CltrlBIC>ZYAJFRT0HCB</CltrlBIC>
Collateral Manager Desc	<CltrlDesc>ES-CLM</CltrlDesc>
Service for FileAct in Push Mode (Collateral Manager only)	<CltrlSvc>t2serclm</CltrlSvc>
DN for FileAct in Push Mode (Collateral Manager only)	<CltrlDN>ou=zyajfrt0hcb,o=bdfefrpp,o=swift</CltrlDN>
Packed File Delivery (Collateral Manager)	<PckdFileCltrl>N</PckdFileCltrl>
Service for FileAct in Push Mode	<Svc>trgt.sfpapss!pa</Svc>
DN for Push Mode	<DN>cn=hcb2,ou=hcb,ou=tssp,ou=unit-dev-2003,o=bdfefrpp,o=swift</DN>
Packed File Delivery	<PckdFile>N</PckdFile>
ECB Account BIC	<ECBAcctBIC>ZYAJFRT0HTE</ECBAcctBIC>
ECB Mirror Account BIC	<ECBMrAcctBIC>ZYBQDEF0027</ECBMrAcctBIC>
CB BIC to be billed for T2S invoices	<CBBldT2SInv>ZYAJFRT0FCB</CBBldT2SInv>
Ham Flag	<HamFlag>Y</HamFlag>
RM Flag	<RMFlag>Y</RMFlag>
SFM Flag	<SFMFlag>Y</SFMFlag>
CRAKS 1 Flag	<CRAKS1Flag>N</CRAKS1Flag>
CRAKS 3 Flag	<CRAKS3Flag>Y</CRAKS3Flag>
CRISP Flag	<CRISPFlag>Y</CRISPFlag>
CRISP - Invoice Flag	<CRISPInvceFlag>N</CRISPInvceFlag>
Maximum Amount Allowed for SF	<MaxForStgFclts>0.00</MaxForStgFclts>
End of CB Information	</CntrlBkInf>

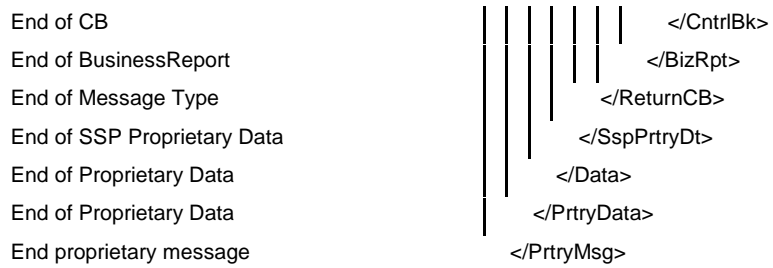

ReturnCB_SD_2

Scope: Error message Response to an XML GetCB

Name Proprietary message	<PrtryMsg>
Message Header	<MsgHdr>
Message Identification	<MsgId>RETURNABC123</MsgId>
End of Message Header	</MsgHdr>
Related	<Rltd>
Reference	<Ref>ABC123</Ref>
End of Related	</Rltd>
Proprietary Data	<PrtryData>
Proprietary Data type	<Tp>ReturnCB</Tp>
Proprietary Data	<Data>
SSP Proprietary Data	<SspPrtryDt>
Message Type	<ReturnCB>
OperationalError	<OprlErr>
Error handling	<Err>
Proprietary error code	<Prtry>S100</Prtry>
End error handling	</Err>
Description	<Desc>No data available for selected criteria - No Central Bank data found</Desc>
End of Operational Error	</OprlErr>
End of Message Type	</ReturnCB>
End of SSP Proprietary Data	</SspPrtryDt>
End of Proprietary Data	</Data>
End of Proprietary Data	</PrtryMsg>
End proprietary message	</PrtryMsg>

6. 5.36 ReturnContactItem

SSP Proprietary Messages

ReturnContactItem_SD

Scope: This is the response to the XML request : GetContactItem

<camt.998.001.xx>

Structure:

Name Proprietary message	<PrtryMsg>
Message Header	<MsgHdr>
Message Identification	<MsgId></MsgId>
End of Message Header	</MsgHdr>
Related	<Rltd>
Reference	<Ref></Ref>
End of Related	</Rltd>
Proprietary Data	<PrtryData>
Proprietary Data type	<Tp>ReturnContactItem</Tp>
Proprietary Data	<Data>
SSP Proprietary Data	<SspPrtryDt>
Message Type	<ReturnContactItem>
Choice amongst	<xorBizRptOprlErr>
BusinessReport	<BizRpt>
Contact Item	<Ctctltm>
Choice amongst	<xorLglNttyldCntrlBkldPtcptldASld>
Legal Entity Identification	<LglNttyld>
Legal Entity Status	<LglNttySts></LglNttySts>
BIC Legal Entity	<BICLglNtty></BICLglNtty>
End of Legal Entity Identification	</LglNttyld>
Central Bank Identification	<CntrlBkld>
CB Status	<CntrlBkSts></CntrlBkSts>
BIC CB	<BICCntrlBk></BICCntrlBk>
End of Central Bank Identification	</CntrlBkld>
Participant Identification	<Partld>
Participant Status	<PartStatus></PartStatus>
CB Responsible	<Ctry>FR</Ctry>
BIC Participant	<BICPtcpt></BICPtcpt>
End of Participant Identification	</Partld>
AS Identification	<ASld>
AS Status	<ASSts></ASSts>
BIC AS	<BICAS></BICAS>
End of AS Identification	</ASld>
End of Choice	</xorLEldCBldPartldASld>
Contact Item Information	<CtctltmInf>
Contact Item Details	<CtctltmDtls>
Function	<Fctn>
Function Type	<FctnTp></FctnTp>
First Name	<FrstNm></FrstNm>
Last Name	<LastNm></LastNm>
End of Function	</Fctn>
Contact Item Id	<Ctctltmld>
Contact Item Type	<CtctltmTp></CtctltmTp>
Contact Item Value	<CtctltmVal></CtctltmVal>

End of Contact Item Id	</CtltmId>
End of Contact Item Details	</CtltmDtls>
End of Contact Item Information	</CtltmInf>
End of Contact Item	</Ctltm>
End of BusinessReport	</BizRpt>
OperationalError	<OprlErr>
Error handling	<Err>
Proprietary error code	<Prtry></Prtry>
End error handling	</Err>
Description	<Desc></Desc>
End of Operational Error	</OprlErr>
End of choice	</xorBizRptOprlErr>
End of Message Type	</ReturnContactItem>
End of SSP Proprietary Data	</SspPrtryDt>
End of Proprietary Data	</Data>
End of Proprietary Data	</PrtryData>
End proprietary message	</PrtryMsg>

Attributes:

name of attribute	format	short description	description
<PrtryMsg>		Name Proprietary message Mandatory	Validation: [1..1]
<MsgHdr>		Message Header Mandatory	Set of characteristics specific to the message Validation: [1..1]
<MsgId></MsgId>	35x	Message Identification Mandatory	Message Identification Validation: [1..1]
</MsgHdr>		End of Message Header Mandatory	Validation: [1..1]
<Rltd>		Related Optional	References a previously received message. Validation: [0..1]
<Ref></Ref>	35x	Reference Mandatory	Unique and unambiguous reference Validation: [1..1]
</Rltd>		End of Related Optional	End of Related Validation: [0..1]
<PrtryData>		Proprietary Data Mandatory	Proprietary Data Validation: [1..1]
<Tp></Tp>	35x	Proprietary Data type Mandatory	Proprietary Data type defines the Type of the free format XML Validation: [1..1]
<Data>		Proprietary Data Mandatory	Proprietary data content Validation: [1..1]
<SspPrtryDt>		SSP Proprietary Data Mandatory	Root element for all SSP proprietary data Validation: [1..1]
<ReturnContactItem>		Message Type Mandatory	Message Type for Static Data Validation: [1..1]
xorBizRptOpriErr		Choice amongst Optional	Choice amongst xorBizRptOpriErr (Type: xor) Validation:

name of attribute	format	short description	description
<BizRpt>		BusinessReport	BusinessReport Rule rationale: The message will contain either the information matching the search criteria of the related Get message or an error indication. Rule description: If BusinessReport is present then OperationalError is not allowed. If BusinessReport is not present, then OperationalError is mandatory.
		Mandatory	Validation: [1..1]
<CtclItm>		Contact Item	Contact Item
		Mandatory	Validation: [1..n]
xorLglNttyldCntrlBkldPtcptldASld		Choice amongst	Choice amongst xorLglNttyldCntrlBkldPtcptldASld (Type: xor)
		Optional	Validation:
<LglNttyld>		Legal Entity Identification	Legal Entity Identification
		Optional	Validation: [0..1]
<LglNttySts>-</LglNttySts>	2x	Legal Entity Status	Status of the record. List of values : "AC" for Active "FU" for Future "RE" for Rejected "AR" for Archived "AF" for Archived Future "DV" for Delivery (Technical) "ID" for In Deletion (Technical) "IC" for In Change
		Mandatory	Validation: [1..1]
<BICLglNtty>-</BICLglNtty>	11x	BIC Legal Entity	A code allocated to a financial institution by a Registration Authority under an international identification scheme, as described in the latest edition of the international standard ISO 9362 "Banking - Banking telecommunication messages - Bank identifier codes". In this case, this is the BIC 11 of a Legal Entity.
		Mandatory	Validation: [1..1]
</LglNttyld>		End of Legal Entity Identification	End of Legal Entity Identification
		Optional	Validation: [0..1]
<CntrlBkld>		Central Bank Identification	Central Bank Identification
		Optional	Validation: [0..1]
<CntrlBkSts>-</CntrlBkSts>	2x	CB Status	Status of the record. List of values : "AC" for Active "FU" for Future "RE" for Rejected "AR" for Archived "AF" for Archived Future "DV" for Delivery (Technical)

name of attribute	format	short description	description
			"ID" for In Deletion (Technical) "IC" for In Change
		Mandatory	Validation: [1..1]
<BICNtrIBk>-</BICNtrIBk>	11x	BIC CB	A code allocated to a financial institution by a Registration Authority under an international identification scheme, as described in the latest edition of the international standard ISO 9362 "Banking - Banking telecommunication messages - Bank identifier codes". In this case, this is the BIC 11 of the Central Bank.
		Mandatory	Validation: [1..1]
</CntrlBkld>		End of Central Bank Identification	End of Central Bank Identification
		Optional	Validation: [0..1]
<PartId>		Participant Identification	Participant Identification
		Optional	Validation: [0..1]
<PartStatus>-</PartStatus>	2x	Participant Status	Status of the record. List of values : "AC" for Active "FU" for Future "RE" for Rejected "AR" for Archived "AF" for Archived Future "DV" for Delivery (Technical) "ID" for In Deletion (Technical) "IC" for In Change
		Mandatory	Validation: [1..1]
<Ctry>-</Ctry>	2!c	CB Responsible	Country Code of the Responsible CB.
		Mandatory	Validation: [1..1]
<BICPtcpt>-</BICPtcpt>	11x	BIC Participant	A code allocated to a financial institution by a Registration Authority under an international identification scheme, as described in the latest edition of the international standard ISO 9362 "Banking - Banking telecommunication messages - Bank identifier codes". In this case, this is the BIC 11 of a Participant.
		Mandatory	Validation: [1..1]
</PartId>		End of Participant Identification	End of Participant Identification
		Optional	Validation: [0..1]
<ASId>		AS Identification	AS Identification
		Optional	Validation: [0..1]
<ASSts>-</ASSts>	2x	AS Status	Status of the record. List of values : "AC" for Active

name of attribute	format	short description	description
			"FU" for Future "RE" for Rejected "AR" for Archived "AF" for Archived Future "DV" for Delivery (Technical) "ID" for In Deletion (Technical) "IC" for In Change
		Mandatory	Validation: [1..1]
<BICAS>-</BICAS>	11x	BIC AS	A code allocated to a financial institution by a Registration Authority under an international identification scheme, as described in the latest edition of the international standard ISO 9362 "Banking - Banking telecommunication messages - Bank identifier codes". In this case, this is the BIC 11 of the Ancillary System.
		Mandatory	Validation: [1..1]
</ASId>		End of AS Identification	End of AS Identification
		Optional	Validation: [0..1]
/xorLglNttyldCntrlBklldPtcptldASld		End of Choice	End of Choice
		Optional	Validation:
<CtctltmInf>		Contact Item Information	Contact Item Information
		Optional	Validation: [0..n]
<CtctltmDtls>		Contact Item Details	Contact Item Details
		Mandatory	Validation: [1..1]
<Fctn>		Function	Function
		Mandatory	Validation: [1..1]
<FctnTp>-</FctnTp>	35x	Function Type	Specifies a character string with a maximum length of 35 characters. Type of function for a Contact Item.
		Mandatory	Validation: [1..1]
<FrstNm>-</FrstNm>	35x	First Name	Specifies a character string with a maximum length of 35 characters. First name of a Contact Item.
		Optional	Validation: [0..1]
<LastNm>-</LastNm>	35x	Last Name	Specifies a character string with a maximum length of 35 characters. Last Name of Contact Item.
		Optional	Validation: [0..1]

name of attribute	format	short description	description
</Fctn>		End of Function	End of Function
		Mandatory	Validation: [1..1]
<CtlmItmId>		Contact Item Id	Contact Item Id
		Optional	Validation: [0..n]
<CtctltmTp>-</CtctltmTp>	35x	Contact Item Type	Type of Contact Item. Max 35 characters, amongst a list of value.
		Mandatory	Validation: [1..1]
<CtctltmVal>-</CtctltmVal>	70x	Contact Item Value	Specifies a character string with a maximum length of 70 characters.
		Mandatory	Validation: [1..1]
</CtlmItmId>		End of Contact Item Id	End of Contact Item Id
		Optional	Validation: [0..1]
</CtlmDtls>		End of Contact Item Details	End of Contact Item Details
		Mandatory	Validation: [1..1]
</CtctltmInf>		End of Contact Item Information	End of Contact Item Information
		Optional	Validation: [0..n]
</Ctctltm>		End of Contact Item	End of Contact Item
		Mandatory	Validation: [1..n]
</BizRpt>		End of BusinessReport	End of BusinessReport
		Mandatory	Validation: [1..1]
<OprlErr>		OperationalError	Rule rationale: The message will contain either the information matching the search criteria of the related Get message or an error indication. Rule description: If BusinessReport is present then OperationalError is not allowed. If BusinessReport is not present, then OperationalError is mandatory. Separate Specification see UDFS books regarding error codes
		Mandatory	Validation: [1..1]
<Err>		Error handling	
		Mandatory	Validation: [1..1]
<Prtry>-</Prtry>	4x	Proprietary error code	Specification of the error, in free format.

name of attribute	format	short description	description
		Mandatory	Validation: [1..1]
</Err>		End error handling Mandatory	Validation: [1..1]
<Desc></Desc>	140x	Description Mandatory	Specification of the error, in free format. Validation: [0..1]
</OprlErr>		End of Operational Error Mandatory	End of Operational Error Validation: [1..1]
/xorBizRptOprlErr		End of choice Optional	End of Choice Validation:
</ReturnContactItem>		End of Message Type Mandatory	End of Message Type for Static Data Validation: [1..1]
</SspPrtryDt>		End of SSP Proprietary Data Mandatory	End of Root element for all SSP proprietary data Validation: [1..1]
</Data>		End of Proprietary Data Mandatory	Validation: [1..1]
</PrtryData>		End of Proprietary Data Mandatory	End of Proprietary Data Validation: [1..1]
</PrtryMsg>		End proprietary message Mandatory	Validation:

Error Codes:

ReturnContactItem_SD_1

Scope: Response to the XML GetContactItem request for a given Legal Entity

Name Proprietary message	<PrtryMsg>
Message Header	<MsgHdr>
Message Identification	<MsgId>RETURNABC123</MsgId>
End of Message Header	</MsgHdr>
Related	<Rltd>
Reference	<Ref>ABC123</Ref>
End of Related	</Rltd>
Proprietary Data	<PrtryData>
Proprietary Data type	<Tp>ReturnContactItem</Tp>
Proprietary Data	<Data>
SSP Proprietary Data	<SspPrtryDt>
Message Type	<ReturnContactItem>
BusinessReport	<BizRpt>
Contact Item	<Ctctltm>
Legal Entity Identification	<LgINttyId>
Legal Entity Status	<LgINttySts>AC</LgINttySts>
BIC Legal Entity	<BICLgINtty>ZYAJFRT0FCB</BICLgINtty>
End of Legal Entity Identification	</LgINttyId>
Contact Item Information	<CtctltmInf>
Contact Item Details	<CtctltmDtls>
Function	<Fctn>
Function Type	<FctnTp>LE Help Desk</FctnTp>
First Name	<FrstNm>Tom</FrstNm>
Last Name	<LastNm>SMITH</LastNm>
End of Function	</Fctn>
Contact Item Id	<CtltmId>
Contact Item Type	<CtctltmTp>Phone</CtctltmTp>
Contact Item Value	<CtctltmVal>0123456789</CtctltmVal>
End of Contact Item Id	</CtltmId>
End of Contact Item Details	</CtctltmDtls>
End of Contact Item Information	</CtctltmInf>
End of Contact Item	</Ctctltm>
Contact Item	<Ctctltm>
Legal Entity Identification	<LgINttyId>
Legal Entity Status	<LgINttySts>AC</LgINttySts>
BIC Legal Entity	<BICLgINtty>ZYAJFRT0FCB</BICLgINtty>
End of Legal Entity Identification	</LgINttyId>
Contact Item Information	<CtctltmInf>
Contact Item Details	<CtctltmDtls>
Function	<Fctn>
Function Type	<FctnTp>LE SSP Operator</FctnTp>
First Name	<FrstNm>Paul</FrstNm>
Last Name	<LastNm>ADAMS</LastNm>
End of Function	</Fctn>
End of Contact Item Details	</CtctltmDtls>
End of Contact Item Information	</CtctltmInf>
End of Contact Item	</Ctctltm>
End of BusinessReport	</BizRpt>
End of Message Type	</ReturnContactItem>

End of SSP Proprietary Data
End of Proprietary Data
End of Proprietary Data
End proprietary message

```
| | | </SspPrtryDt>  
| | </Data>  
| </PrtryData>  
</PrtryMsg>
```

ReturnContactItem_SD_2

Scope: Response to the XML GetContactItem request for a given Central Bank

Name Proprietary message	<PrtryMsg>
Message Header	<MsgHdr>
Message Identification	<MsgId>RETURNABC123</MsgId>
End of Message Header	</MsgHdr>
Related	<Rltd>
Reference	<Ref>ABC123</Ref>
End of Related	</Rltd>
Proprietary Data	<PrtryData>
Proprietary Data type	<Tp>ReturnContactItem</Tp>
Proprietary Data	<Data>
SSP Proprietary Data	<SspPrtryDt>
Message Type	<ReturnContactItem>
BusinessReport	<BizRpt>
Contact Item	<Ctctltm>
Central Bank Identification	<CntrlBkld>
CB Status	<CntrlBkSts>AC</CntrlBkSts>
BIC CB	<BICCntrlBk>ZYAJFRT0HCB</BICCntrlBk>
End of Central Bank Identification	</CntrlBkld>
Contact Item Information	<CtctltmInf>
Contact Item Details	<CtctltmDtls>
Function	<Fctn>
Function Type	<FctnTp>CB Help Desk</FctnTp>
First Name	<FrstNm>Bill</FrstNm>
Last Name	<LastNm>HENRY</LastNm>
End of Function	</Fctn>
Contact Item Id	<CtltmId>
Contact Item Type	<CtctltmTp>Phone</CtctltmTp>
Contact Item Value	<CtctltmVal>1212121212</CtctltmVal>
End of Contact Item Id	</CtltmId>
End of Contact Item Details	</CtltmDtls>
End of Contact Item Information	</CtctltmInf>
End of Contact Item	</Ctctltm>
Contact Item	<Ctctltm>
Central Bank Identification	<CntrlBkld>
CB Status	<CntrlBkSts>AC</CntrlBkSts>
BIC CB	<BICCntrlBk>ZYAJFRT0HCB</BICCntrlBk>
End of Central Bank Identification	</CntrlBkld>
Contact Item Information	<CtctltmInf>
Contact Item Details	<CtctltmDtls>
Function	<Fctn>
Function Type	<FctnTp>CB Operator</FctnTp>
First Name	<FrstNm>Ron</FrstNm>
Last Name	<LastNm>HOWARD</LastNm>
End of Function	</Fctn>
End of Contact Item Details	</CtltmDtls>
End of Contact Item Information	</CtctltmInf>
End of Contact Item	</Ctctltm>
End of BusinessReport	</BizRpt>
End of Message Type	</ReturnContactItem>

End of SSP Proprietary Data
End of Proprietary Data
End of Proprietary Data
End proprietary message

```
| | | </SspPrtryDt>  
| | </Data>  
| </PrtryData>  
</PrtryMsg>
```

ReturnContactItem_SD_3

Scope: Response to the XML GetContactItem request for a given Participant

Name Proprietary message	<PrtryMsg>
Message Header	<MsgHdr>
Message Identification	<MsgId>RETURNABC123</MsgId>
End of Message Header	</MsgHdr>
Related	<Rltd>
Reference	<Ref>ABC123</Ref>
End of Related	</Rltd>
Proprietary Data	<PrtryData>
Proprietary Data type	<Tp>ReturnContactItem</Tp>
Proprietary Data	<Data>
SSP Proprietary Data	<SspPrtryDt>
Message Type	<ReturnContactItem>
BusinessReport	<BizRpt>
Contact Item	<Ctctltm>
Participant Identification	<PartId>
Participant Status	<PartStatus>AC</PartStatus>
CB Responsible	<Ctry>FR</Ctry>
BIC Participant	<BICPtcpt>SDMFRCRM010</BICPtcpt>
End of Participant Identification	</PartId>
Contact Item Information	<CtctltmInf>
Contact Item Details	<CtctltmDtls>
Function	<Fctn>
Function Type	<FctnTp>Participant User Help Desk</FctnTp>
First Name	<FrstNm>Luc</FrstNm>
Last Name	<LastNm>CELIER</LastNm>
End of Function	</Fctn>
Contact Item Id	<CtltmId>
Contact Item Type	<CtctltmTp>Phone</CtctltmTp>
Contact Item Value	<CtctltmVal>5454546546546546</CtctltmVal>
End of Contact Item Id	</CtltmId>
End of Contact Item Details	</CtltmDtls>
End of Contact Item Information	</CtctltmInf>
End of Contact Item	</Ctctltm>
Contact Item	<Ctctltm>
Participant Identification	<PartId>
Participant Status	<PartStatus>AC</PartStatus>
CB Responsible	<Ctry>FR</Ctry>
BIC Participant	<BICPtcpt>SDMFRCRM010</BICPtcpt>
End of Participant Identification	</PartId>
Contact Item Information	<CtctltmInf>
Contact Item Details	<CtctltmDtls>
Function	<Fctn>
Function Type	<FctnTp>SSP Operator</FctnTp>
First Name	<FrstNm>Henri</FrstNm>
Last Name	<LastNm>DUPOND</LastNm>
End of Function	</Fctn>
End of Contact Item Details	</CtltmDtls>
End of Contact Item Information	</CtctltmInf>
End of Contact Item	</Ctctltm>

Contact Item	<Ctctltm>
Participant Identification	<PartId>
Participant Status	<PartStatus>AC</PartStatus>
CB Responsible	<Ctry>FR</Ctry>
BIC Participant	<BICPtcpt>SDMFRCRM010</BICPtcpt>
End of Participant Identification	</PartId>
Contact Item Information	<CtctltmInf>
Contact Item Details	<CtctltmDtls>
Function	<Fctn>
Function Type	<FctnTp>ECB Coordinator</FctnTp>
First Name	<FrstNm>Thomas</FrstNm>
End of Function	</Fctn>
End of Contact Item Details	</CtctltmDtls>
End of Contact Item Information	</CtctltmInf>
End of Contact Item	</Ctctltm>
Contact Item	<Ctctltm>
Participant Identification	<PartId>
Participant Status	<PartStatus>AC</PartStatus>
CB Responsible	<Ctry>FR</Ctry>
BIC Participant	<BICPtcpt>SDMFRCRM010</BICPtcpt>
End of Participant Identification	</PartId>
Contact Item Information	<CtctltmInf>
Contact Item Details	<CtctltmDtls>
Function	<Fctn>
Function Type	<FctnTp>CB National User Help Desk</FctnTp>
End of Function	</Fctn>
End of Contact Item Details	</CtctltmDtls>
End of Contact Item Information	</CtctltmInf>
End of Contact Item	</Ctctltm>
End of BusinessReport	</BizRpt>
End of Message Type	</ReturnContactItem>
End of SSP Proprietary Data	</SspPrtryDt>
End of Proprietary Data	</Data>
End of Proprietary Data	</PrtryData>
End proprietary message	</PrtryMsg>

ReturnContactItem_SD_4

Scope: Response to the XML GetContactItem request for a given Ancillary System

Name Proprietary message	<PrtryMsg>
Message Header	<MsgHdr>
Message Identification	<MsgId>RETURNABC123</MsgId>
End of Message Header	</MsgHdr>
Related	<Rltd>
Reference	<Ref>ABC123</Ref>
End of Related	</Rltd>
Proprietary Data	<PrtryData>
Proprietary Data type	<Tp>ReturnContactItem</Tp>
Proprietary Data	<Data>
SSP Proprietary Data	<SspPrtryDt>
Message Type	<ReturnContactItem>
BusinessReport	<BizRpt>
Contact Item	<Ctctltm>
AS Identification	<ASId>
AS Status	<ASSts>FU</ASSts>
BIC AS	<BICAS>ZYAJFRT0BAA</BICAS>
End of AS Identification	</ASId>
Contact Item Information	<CtctltmInf>
Contact Item Details	<CtctltmDtls>
Function	<Fctn>
Function Type	<FctnTp>AS Help Desk</FctnTp>
First Name	<FrstNm>John</FrstNm>
Last Name	<LastNm>WAYNE</LastNm>
End of Function	</Fctn>
Contact Item Id	<CtltmId>
Contact Item Type	<CtctltmTp>Phone</CtctltmTp>
Contact Item Value	<CtctltmVal>7878787878</CtctltmVal>
End of Contact Item Id	</CtltmId>
End of Contact Item Details	</CtltmDtls>
End of Contact Item Information	</CtctltmInf>
End of Contact Item	</Ctctltm>
Contact Item	<Ctctltm>
AS Identification	<ASId>
AS Status	<ASSts>FU</ASSts>
BIC AS	<BICAS>ZYAJFRT0BAA</BICAS>
End of AS Identification	</ASId>
Contact Item Information	<CtctltmInf>
Contact Item Details	<CtctltmDtls>
Function	<Fctn>
Function Type	<FctnTp>AS Operator</FctnTp>
First Name	<FrstNm>John M</FrstNm>
Last Name	<LastNm>KEYNES</LastNm>
End of Function	</Fctn>
End of Contact Item Details	</CtltmDtls>
End of Contact Item Information	</CtctltmInf>
End of Contact Item	</Ctctltm>
End of BusinessReport	</BizRpt>
End of Message Type	</ReturnContactItem>

End of SSP Proprietary Data
End of Proprietary Data
End of Proprietary Data
End proprietary message

```
| | | </SspPrtryDt>  
| | </Data>  
| </PrtryData>  
</PrtryMsg>
```

ReturnContactItem_SD_5

Scope: This is the Error response to the XML request : GetContactItem

Name Proprietary message	<PrtryMsg>
Message Header	<MsgHdr>
Message Identification	<MsgId>RETURNABC123</MsgId>
End of Message Header	</MsgHdr>
Related	<Rltd>
Reference	<Ref>ABC123</Ref>
End of Related	</Rltd>
Proprietary Data	<PrtryData>
Proprietary Data type	<Tp>ReturnContactItem</Tp>
Proprietary Data	<Data>
SSP Proprietary Data	<SspPrtryDt>
Message Type	<ReturnContactItem>
OperationalError	<OprlErr>
Error handling	<Err>
Proprietary error code	<Prtry>S100</Prtry>
End error handling	</Err>
Description	<Desc>No data available for selected criteria - No Contact Item data found</Desc>
End of Operational Error	</OprlErr>
End of Message Type	</ReturnContactItem>
End of SSP Proprietary Data	</SspPrtryDt>
End of Proprietary Data	</Data>
End of Proprietary Data	</PrtryData>
End proprietary message	</PrtryMsg>

6. 5.37 ReturnDirectDebit

SSP Proprietary Messages

ReturnDirectDebit_SD

Scope: This is the response to the XML request GetDirectDebit

<camt.998.001.xx>

Structure:

Name Proprietary message	<PrtryMsg>
Message Header	<MsgHdr>
Message Identification	<MsgId></MsgId>
End of Message Header	</MsgHdr>
Related	<Rltd>
Reference	<Ref></Ref>
End of Related	</Rltd>
Proprietary Data	<PrtryData>
Proprietary Data type	<Tp>ReturnDirectDebit</Tp>
Proprietary Data	<Data>
SSP Proprietary Data	<SspPrtryDt>
Message Type	<ReturnDirectDebit>
Choice amongst	<xorDrctDbtBizErr>
BusinessReport	<BizRpt>
Direct Debit	<DrctDbt>
Participant Identification	<PtcptId>
CB Responsible	<Ctry></Ctry>
BIC Participant	<BICPtcpt></BICPtcpt>
End of Participant Identification	</PtcptId>
Direct Debit List	<DrctDbtList>
Direct Debit Information	<DrctDbtInf>
Record Status	<RecSts></RecSts>
Direct Debit Reference	<DrctDbtRef></DrctDbtRef>
Direct Debit Issuer's Name	<DrctDbtIssr></DrctDbtIssr>
BIC of the Direct Debit Issuer	<BICIssr></BICIssr>
Flag Is Futur Participant	<IsFutrPrct></IsFutrPrct>
Maximum Amount for this counterpart	<MaxAmtCtrPty></MaxAmtCtrPty>
Maximum Amount per payment for Direct Debit	<MaxAmtPmt></MaxAmtPmt>
End of Direct Debit Information	</DrctDbtInf>
End of Direct Debit List	</DrctDbtList>
End of Direct Debit	</DrctDbt>
End of BusinessReport	</BizRpt>
OperationalError	<OpriErr>
Error handling	<Err>
Proprietary error code	<Prtry></Prtry>
End error handling	</Err>
Description	<Desc></Desc>
End of Operational Error	</OpriErr>
End of choice	</xorDrctDbtBizErr>
End of Message Type	</ReturnDirectDebit>
End of SSP Proprietary Data	</SspPrtryDt>
End of Proprietary Data	</Data>
End of Proprietary Data	</PrtryData>
End proprietary message	</PrtryMsg>

Attributes:

name of attribute	format	short description	description
<PrtryMsg>		Name Proprietary message Mandatory	Validation:
<MsgHdr>		Message Header Mandatory	Set of characteristics specific to the message Validation: [1..1]
<MsgId>-</MsgId>	35x	Message Identification Mandatory	Message Identification Validation: [1..1]
</MsgHdr>		End of Message Header Mandatory	Validation: [1..1]
<Rltd>		Related Optional	References a previously received message. Validation: [0..1]
<Ref>-</Ref>	35x	Reference Mandatory	Unique and unambiguous reference Validation: [1..1]
</Rltd>		End of Related Optional	End of Related Validation: [0..1]
<PrtryData>		Proprietary Data Mandatory	Proprietary Data Validation: [1..1]
<Tp>-</Tp>	35x	Proprietary Data type Mandatory	Proprietary Data type defines the Type of the free format XML Validation: [1..1]
<Data>		Proprietary Data Mandatory	Proprietary data content Validation: [1..1]
<SspPrtryDt>		SSP Proprietary Data Mandatory	Root element for all SSP proprietary data Validation: [1..1]
<ReturnDirectDebit>		Message Type Mandatory	Message Type for Static Data Validation: [1..1]
xorBizRptOpriErr		Choice amongst Optional	Choice amongst xorBizRptOpriErr (Type: xor) Validation:

name of attribute	format	short description	description
<BizRpt>		BusinessReport	BusinessReport Rule rationale: The message will contain either the information matching the search criteria of the related Get message or an error indication. Rule description: If BusinessReport is present then OperationalError is not allowed. If BusinessReport is not present, then OperationalError is mandatory.
		Mandatory	Validation: [1..1]
<DrctDbt>		Direct Debit	Direct Debit
		Mandatory	Validation: [1..n]
<PtcptId>		Participant Identification	Participant Identification
		Mandatory	Validation: [1..1]
<Ctry>-</Ctry>	2!c	CB Responsible	Country Code of the Responsible CB.
		Mandatory	Validation: [1..1]
<BICPcpt>-</BICPcpt>	11x	BIC Participant	A code allocated to a financial institution by a Registration Authority under an international identification scheme, as described in the latest edition of the international standard ISO 9362 "Banking - Banking telecommunication messages - Bank identifier codes". In this case, this is the BIC 11 of a Participant.
		Mandatory	Validation: [1..1]
</PtcptId>		End of Participant Identification	End of Participant Identification
		Mandatory	Validation: [1..1]
<DrctDbtList>		Direct Debit List	Direct Debit List
		Optional	Validation: [0..1]
<DrctDbtInf>		Direct Debit Information	Direct Debit Information
		Optional	Validation: [0..n]
<RecSts>-</RecSts>	2x	Record Status	Status of the record. List of values : "AC" for Active "FU" for Future "RE" for Rejected "AR" for Archived "AF" for Archived Future "IC" for In Change "DV" for Delivery (Technical) "ID" for In Deletion (Technical)
			For more information on status management, refer to the ICM UserHandBook.

name of attribute	format	short description	description
		Mandatory	Validation: [1..1]
<DrctDbtRef>-</DrctDbtRef>	35x	Direct Debit Reference	Specifies a character string with a maximum length of 35 characters. This is the reference of the Direct Debit.
		Mandatory	Validation: [1..1]
<DrctDbtIssr>-</DrctDbtIssr>	35x	Direct Debit Issuer's Name	Specifies a character string with a maximum length of 35 characters. This is the name of the Direct Debit Issuer.
		Mandatory	Validation: [1..1]
<BICIssr>-</BICIssr>	4!a2!a2!c[3!c]	BIC of the Direct Debit Issuer	A code allocated to a financial institution by a Registration Authority under an international identification scheme, as described in the latest edition of the international standard ISO 9362 "Banking - Banking telecommunication messages - Bank identifier codes". In this case, this is the BIC 11 of the Direct Debit Issuer (BIC Participant).
		Mandatory	Validation: [1..1]
<IsFutrPrct>-</IsFutrPrct>	1!a	Flag Is Futur Participant	A flag with two values : 'Y' or 'N'. This flag indicates whether a participant has a status Future or not.
		Mandatory	Validation: [1..1]
<MaxAmtCtrPty>-</MaxAmtCtrPty>	18!d	Maximum Amount for this counterpart	Maximum Amount for this counterpart in case of Direct Debit. Amount, made of a maximum of 17 numbers and one digit (decimal coma)
		Optional	Validation: [0..1]
<MaxAmtPmt>-</MaxAmtPmt>	18!d	Maximum Amount per payment for Direct Debit	Maximum Amount per payment for Direct Debit. Amount, made of a maximum of 17 numbers and one digit (decimal coma)
		Optional	Validation: [0..1]
</DrctDbtInf>		End of Direct Debit Information	End of Direct Debit Information
		Optional	Validation: [0..n]
</DrctDbtList>		End of Direct Debit List	End of Direct Debit List
		Optional	Validation: [0..n]
</DrctDbt>		End of Direct Debit	End of Direct Debit
		Mandatory	Validation: [1..n]

name of attribute	format	short description	description
<BizRpt>		End of BusinessReport	End of BusinessReport
		Mandatory	Validation: [1..1]
<OprlErr>		OperationalError	Rule rationale: The message will contain either the information matching the search criteria of the related Get message or an error indication. Rule description: If BusinessReport is present then OperationalError is not allowed. If BusinessReport is not present, then OperationalError is mandatory. Separate Specification see UDFS books regarding error codes
		Mandatory	Validation: [1..1]
<Err>		Error handling	
		Mandatory	Validation: [1..1]
<Prtry>-</Prtry>	4x	Proprietary error code	Specification of the error, in free format.
		Mandatory	Validation: [1..1]
</Err>		End error handling	
		Mandatory	Validation: [1..1]
<Desc>-</Desc>	140x	Description	Specification of the error, in free format.
		Optional	Validation: [0..1]
</OprlErr>		End of Operational Error	End of Operational Error
		Mandatory	Validation: [1..1]
/xorBizRptOprlErr		End of choice	End of Choice
		Optional	Validation:
</ReturnDirectDebit>		End of Message Type	End of Message Type for Static Data
		Mandatory	Validation: [1..1]
</SspPrtryDt>		End of SSP Proprietary Data	End of Root element for all SSP proprietary data
		Mandatory	Validation: [1..1]
</Data>		End of Proprietary Data	
		Mandatory	Validation: [1..1]
</PrtryData>		End of Proprietary Data	End of Proprietary Data
		Mandatory	Validation: [1..1]

name of attribute	format	short description	description
</PrtryMsg>		End proprietary message	
		Mandatory	Validation:

Error Codes:

ReturnDirectDebit_SD_1

Scope: Response to the XML GetDirectDebit request

Name Proprietary message	<PrtryMsg>
Message Header	<MsgHdr>
Message Identification	<MsgId>13587813400871443052472</MsgId>
End of Message Header	</MsgHdr>
Related	<Rltd>
Reference	<Ref>GETDD20130121</Ref>
End of Related	</Rltd>
Proprietary Data	<PrtryData>
Proprietary Data type	<Tp>ReturnDirectDebit</Tp>
Proprietary Data	<Data>
SSP Proprietary Data	<SspPrtryDt>
Message Type	<ReturnDirectDebit>
BusinessReport	<BizRpt>
Direct Debit	<DrctDbt>
Participant Identification	<PtcptId>
CB Responsible	<Ctry>BE</Ctry>
BIC Participant	<BICPtcpt>ZYAJFRT0BS1</BICPtcpt>
End of Participant Identification	</PtcptId>
Direct Debit List	<DrctDbtList>
Direct Debit Information	<DrctDbtInf>
Record Status	<RecSts>AC</RecSts>
Direct Debit Reference	<DrctDbtRef>Direct Debit GUA</DrctDbtRef>
Direct Debit Issuer's Name	<DrctDbtIssr>ASG - BKA</DrctDbtIssr>
BIC of the Direct Debit Issuer	<BICIssr>ZYAJFRT0BKA</BICIssr>
Flag Is Futur Participant	<IsFutrPrct>N</IsFutrPrct>
Maximum Amount for this counterpart	<MaxAmtCtrPty>3000.00</MaxAmtCtrPty>
Maximum Amount per payment for Direct Debit	<MaxAmtPmt>3000.00</MaxAmtPmt>
End of Direct Debit Information	</DrctDbtInf>
End of Direct Debit List	</DrctDbtList>
End of Direct Debit	</DrctDbt>
End of BusinessReport	</BizRpt>
End of Message Type	</ReturnDirectDebit>
End of SSP Proprietary Data	</SspPrtryDt>
End of Proprietary Data	</Data>
End of Proprietary Data	</PrtryData>
End proprietary message	</PrtryMsg>

ReturnDirectDebit_SD_2

Scope: Error message Response to the XML GetDirectDebit request with an incorrect Country Code

Name Proprietary message	<PrtryMsg>
Message Header	<MsgHdr>
Message Identification	<MsgId>13588456071882135902667</MsgId>
End of Message Header	</MsgHdr>
Related	<Rltd>
Reference	<Ref>GETDD20130122</Ref>
End of Related	</Rltd>
Proprietary Data	<PrtryData>
Proprietary Data type	<Tp>ReturnDirectDebit</Tp>
Proprietary Data	<Data>
SSP Proprietary Data	<SspPrtryDt>
Message Type	<ReturnDirectDebit>
OperationalError	<OprlErr>
Error handling	<Err>
Proprietary error code	<Prtry>S500</Prtry>
End error handling	</Err>
Description	<Desc>Inconsistent data input - Wrong value in field [ISOCC]</Desc>
End of Operational Error	</OprlErr>
End of Message Type	</ReturnDirectDebit>
End of SSP Proprietary Data	</SspPrtryDt>
End of Proprietary Data	</Data>
End of Proprietary Data	</PrtryData>
End proprietary message	</PrtryMsg>

6. 5.38 ReturnErrorCode

SSP Proprietary Messages

ReturnErrorCode_SD

Scope: This is the response to the XML request : GetErrorCode

<camt.998.001.xx>

Structure:

Name Proprietary message	<PrtryMsg>
Message Header	<MsgHdr>
Message Identification	<MsgId></MsgId>
End of Message Header	</MsgHdr>
Related	<Rltd>
Reference	<Ref></Ref>
End of Related	</Rltd>
Proprietary Data	<PrtryData>
Proprietary Data type	<Tp>ReturnErrorCode</Tp>
Proprietary Data	<Data>
SSP Proprietary Data	<SspPrtryDt>
Message Type	<ReturnErrorCode>
Choice amongst	<xorBizRptOprlErr>
BusinessReport	<BizRpt>
Error Code	<ErrCd>
End of Error Code Information	<ErrCdInf>
Error Category Name	<ErrCtgyNm></ErrCtgyNm>
Error Code SSP	<ErrCdSSP></ErrCdSSP>
Error Code Y-Copy	<ErrCdyCpy></ErrCdyCpy>
Error Code V Shape	<ErrCdVShp></ErrCdVShp>
Error Code XML	<ErrCdXML></ErrCdXML>
Error Text	<ErrTxt></ErrTxt>
End of Error Code Information	</ErrCdInf>
End of Error Code	</ErrCd>
End of BusinessReport	</BizRpt>
OperationalError	<OprlErr>
Error handling	<Err>
Proprietary error code	<Prtry></Prtry>
End error handling	</Err>
Description	<Desc></Desc>
End of Operational Error	</OprlErr>
End of choice	</xorBizRptOprlErr>
End of Message Type	</ReturnErrorCode>
End of SSP Proprietary Data	</SspPrtryDt>
End of Proprietary Data	</Data>
End of Proprietary Data	</PrtryData>
End proprietary message	</PrtryMsg>

Attributes:

name of attribute	format	short description	description
<PrtryMsg>		Name Proprietary message Mandatory	Validation: [1..1]
<MsgHdr>		Message Header Mandatory	Set of characteristics specific to the message Validation: [1..1]
<MsgId>-</MsgId>	35x	Message Identification Mandatory	Message Identification Validation: [1..1]
</MsgHdr>		End of Message Header Mandatory	Validation: [1..1]
<Rltd>		Related Optional	References a previously received message. Validation: [0..1]
<Ref>-</Ref>	35x	Reference Mandatory	Unique and unambiguous reference Validation: [1..1]
</Rltd>		End of Related Optional	End of Related Validation: [0..1]
<PrtryData>		Proprietary Data Mandatory	Proprietary Data Validation: [1..1]
<Tp>-</Tp>	35x	Proprietary Data type Mandatory	Proprietary Data type defines the Type of the free format XML Validation: [1..1]
<Data>		Proprietary Data Mandatory	Proprietary data content Validation: [1..1]
<SspPrtryDt>		SSP Proprietary Data Mandatory	Root element for all SSP proprietary data Validation: [1..1]
<ReturnErrorCode>		Message Type Mandatory	Message Type for Static Data Validation: [1..1]
xorBizRptOpriErr		Choice amongst Optional	Choice amongst xorBizRptOpriErr (Type: xor) Validation:

name of attribute	format	short description	description
<BizRpt>		BusinessReport	BusinessReport Rule rationale: The message will contain either the information matching the search criteria of the related Get message or an error indication. Rule description: If BusinessReport is present then OperationalError is not allowed. If BusinessReport is not present, then OperationalError is mandatory.
		Mandatory	Validation: [1..1]
<ErrCd>		Error Code	Error Code
		Mandatory	Validation: [1..n]
</ErrCdInf>		End of Error Code Information	End of Error Code Information
		Mandatory	Validation: [1..1]
<ErrCtgyNm>-</ErrCtgyNm>	35x	Error Category Name	Specifies a character string with a maximum length of 35 characters. This is the name fo the error.
		Optional	Validation: [0..1]
<ErrCdSSP>-</ErrCdSSP>	Max4AlphanumericText	Error Code SSP	Made of 4 characters. This is the code of an SSP error.
		Mandatory	Validation: [1..1]
<ErrCdYCOPY>-</ErrCdYCOPY>	2x	Error Code Y-Copy	Made of 4 characters. This is the error code for a Y-Copy flow.
		Optional	Validation: [0..1]
<ErrCdVShp>-</ErrCdVShp>	Max4AlphanumericText	Error Code V Shape	Made of 4 characters. This is the error code for a V Shape flow.
		Optional	Validation: [0..1]
<ErrCdXML>-</ErrCdXML>	4x	Error Code XML	Made of 4 characters. This is the error code for an XML flow.
		Optional	Validation: [0..1]
<ErrTxt>-</ErrTxt>	210x	Error Text	This is the text related to the error.
		Optional	Validation: [0..1]
</ErrCdInf>		End of Error Code Information	End of Error Code Information
		Mandatory	Validation: [1..1]
</ErrCd>		End of Error Code	End of Error Code
		Mandatory	Validation: [1..1]

name of attribute	format	short description	description
</BizRpt>		End of BusinessReport Mandatory	End of BusinessReport Validation: [1..1]
<OprlErr>		OperationalError Mandatory	Rule rationale: The message will contain either the information matching the search criteria of the related Get message or an error indication. Rule description: If BusinessReport is present then OperationalError is not allowed. If BusinessReport is not present, then OperationalError is mandatory. Separate Specification see UDFS books regarding error codes Validation: [1..1]
<Err>		Error handling Mandatory	Validation: [1..1]
<Prtry>-</Prtry>	4x	Proprietary error code Mandatory	Specification of the error, in free format. Validation: [1..1]
</Err>		End error handling Mandatory	Validation: [1..1]
<Desc>-</Desc>	140x	Description Optional	Specification of the error, in free format. Validation: [0..1]
</OprlErr>		End of Operational Error Mandatory	End of Operational Error Validation: [1..1]
/xorBizRptOprlErr		End of choice Optional	End of Choice Validation:
</ReturnErrorCode>		End of Message Type Mandatory	End of Message Type for Static Data Validation: [1..1]
</SspPrtryDt>		End of SSP Proprietary Data Mandatory	End of Root element for all SSP proprietary data Validation: [1..1]
</Data>		End of Proprietary Data Mandatory	Validation: [1..1]
</PrtryData>		End of Proprietary Data Mandatory	End of Proprietary Data Validation: [1..1]

name of attribute	format	short description	description
</PrtryMsg>		End proprietary message	
		Mandatory	Validation:

Error Codes:

ReturnErrorCode_SD_1

Scope: Response to the XML GetErrorCode

Name Proprietary message	<PrtryMsg>
Message Header	<MsgHdr>
Message Identification	<MsgId>RETURNABC123</MsgId>
End of Message Header	</MsgHdr>
Related	<Rltd>
Reference	<Ref>ABC123</Ref>
End of Related	</Rltd>
Proprietary Data	<PrtryData>
Proprietary Data type	<Tp>ReturnErrorCode</Tp>
Proprietary Data	<Data>
SSP Proprietary Data	<SspPrtryDt>
Message Type	<ReturnErrorCode>
BusinessReport	<BizRpt>
Error Code	<ErrCd>
End of Error Code Information	<ErrCdInf>
Error Category Name	<ErrCtgyNm>AS specific</ErrCtgyNm>
Error Code SSP	<ErrCdSSP>A01</ErrCdSSP>
Error Code XML	<ErrCdXML>A001</ErrCdXML>
Error Text	<ErrTxt>Sender not allowed</ErrTxt>
End of Error Code Information	</ErrCdInf>
End of Error Code	</ErrCd>
Error Code	<ErrCd>
End of Error Code Information	</ErrCdInf>
Error Category Name	<ErrCtgyNm>HAM/SF/RM/CM specific</ErrCtgyNm>
Error Code SSP	<ErrCdSSP>H01</ErrCdSSP>
Error Code V Shape	<ErrCdVShp>X101</ErrCdVShp>
Error Code XML	<ErrCdXML>H001</ErrCdXML>
Error Text	<ErrTxt>Sender not allowed</ErrTxt>
End of Error Code Information	</ErrCdInf>
End of Error Code	</ErrCd>
Error Code	<ErrCd>
End of Error Code Information	</ErrCdInf>
Error Category Name	<ErrCtgyNm>HAM/SF/RM/CM specific</ErrCtgyNm>
Error Code SSP	<ErrCdSSP>H04</ErrCdSSP>
Error Code Y-Copy	<ErrCdYCpy>M4</ErrCdYCpy>
Error Code V Shape	<ErrCdVShp>XT16</ErrCdVShp>
Error Code XML	<ErrCdXML>H004</ErrCdXML>
Error Text	<ErrTxt>Operation not allowed (e.g. cross border)</ErrTxt>
End of Error Code Information	</ErrCdInf>
End of Error Code	</ErrCd>
End of BusinessReport	</BizRpt>
End of Message Type	</ReturnErrorCode>
End of SSP Proprietary Data	</SspPrtryDt>
End of Proprietary Data	</Data>
End of Proprietary Data	</PrtryData>
End proprietary message	</PrtryMsg>

ReturnErrorCode_SD_2

Scope: Error message Response to the XML GetErrorCode request

Name Proprietary message	<PrtryMsg>
Message Header	<MsgHdr>
Message Identification	<MsgId>13588456071882135902668</MsgId>
End of Message Header	</MsgHdr>
Related	<Rltd>
Reference	<Ref>ABC123</Ref>
End of Related	</Rltd>
Proprietary Data	<PrtryData>
Proprietary Data type	<Tp>ReturnErrorCode</Tp>
Proprietary Data	<Data>
SSP Proprietary Data	<SspPrtryDt>
Message Type	<ReturnErrorCode>
OperationalError	<OpriErr>
Error handling	<Err>
Proprietary error code	<Prtry>4515</Prtry>
End error handling	</Err>
Description	<Desc>Invalid Query</Desc>
End of Operational Error	</OpriErr>
End of Message Type	</ReturnErrorCode>
End of SSP Proprietary Data	</SspPrtryDt>
End of Proprietary Data	</Data>
End of Proprietary Data	</PrtryData>
End proprietary message	</PrtryMsg>

6. 5.39 ReturnEvent

SSP Proprietary Messages

ReturnEvent_SD

Scope: This is the response to the XML request : GetEvent

<camt.998.001.xx>

Structure:

Name Proprietary message	<PrtryMsg>
Message Header	<MsgHdr>
Message Identification	<MsgId></MsgId>
End of Message Header	</MsgHdr>
Related	<Rltd>
Reference	<Ref></Ref>
End of Related	</Rltd>
Proprietary Data	<PrtryData>
Proprietary Data type	<Tp>ReturnEvent</Tp>
Proprietary Data	<Data>
SSP Proprietary Data	<SspPrtryDt>
Message Type	<ReturnEvent>
Choice amongst	<xorBizRptOprlErr>
BusinessReport	<BizRpt>
TARGET Event	<Evt>
Record Status Information	<RecStsInf>
Planned Change	<PlndChng></PlndChng>
Record Status	<RecSts></RecSts>
First Activation Date	<FrstDt></FrstDt>
Modification Date	<ModDt></ModDt>
End Date	<EndDt></EndDt>
End of Record Status Information	</RecStsInf>
Event Information	<EvtInf>
Event Type	<EvtTp></EvtTp>
Event Time	<EvtTm></EvtTm>
Event Description	<EvtDesc></EvtDesc>
Country Code for Event	<EvtCtry></EvtCtry>
Module	<Mdle></Mdle>
End of Event Information	</EvtInf>
End of TARGET Event	</Evt>
End of BusinessReport	</BizRpt>
OperationalError	<OprlErr>
Error handling	<Err>
Proprietary error code	<Prtry></Prtry>
End error handling	</Err>
Description	<Desc></Desc>
End of Operational Error	</OprlErr>
End of choice	</xorBizRptOprlErr>
End of Message Type	</ReturnEvent>
End of SSP Proprietary Data	</SspPrtryDt>
End of Proprietary Data	</Data>
End of Proprietary Data	</PrtryData>
End proprietary message	</PrtryMsg>

Attributes:

name of attribute	format	short description	description
<PrtryMsg>		Name Proprietary message Mandatory	Validation: [1..1]
<MsgHdr>		Message Header Mandatory	Set of characteristics specific to the message Validation: [1..1]
<MsgId></MsgId>	35x	Message Identification Mandatory	Message Identification Validation: [1..1]
</MsgHdr>		End of Message Header Mandatory	Validation: [1..1]
<Rltd>		Related Optional	References a previously received message. Validation: [0..1]
<Ref></Ref>	35x	Reference Mandatory	Unique and unambiguous reference Validation: [1..1]
</Rltd>		End of Related Optional	End of Related Validation: [0..1]
<PrtryData>		Proprietary Data Mandatory	Proprietary Data Validation: [1..1]
<Tp></Tp>	35x	Proprietary Data type Mandatory	Proprietary Data type defines the Type of the free format XML Validation: [1..1]
<Data>		Proprietary Data Mandatory	Proprietary data content Validation: [1..1]
<SspPrtryDt>		SSP Proprietary Data Mandatory	Root element for all SSP proprietary data Validation: [1..1]
<ReturnEvent>		Message Type Mandatory	Message Type for Static Data Validation: [1..1]
xorBizRptOpriErr		Choice amongst Optional	Choice amongst xorBizRptOpriErr (Type: xor) Validation:

name of attribute	format	short description	description
<BizRpt>		BusinessReport	<p>BusinessReport</p> <p>Rule rationale: The message will contain either the information matching the search criteria of the related Get message or an error indication.</p> <p>Rule description: If BusinessReport is present then OperationalError is not allowed. If BusinessReport is not present, then OperationalError is mandatory.</p> <p>Mandatory</p> <p>Validation: [1..1]</p>
<Evt>		TARGET Event	<p>TARGET Event</p> <p>Mandatory</p> <p>Validation: [1..n] Type [1..1] ScheduledTime [1..1] EffectiveTime [0..1]</p>
<RecStsInf>		Record Status Information	<p>Record Status Information</p> <p>Mandatory</p> <p>Validation: [1..1]</p>
<PlnndChng>-</PlnndChng>	1!a	Planned Change	<p>Information on record regarding the presence of a future record. Values may be :</p> <p>"N" if no future record is present "D" if the record will be deleted "M" if a future record exists</p> <p>Note : the Planned Change flag has been added in order to help users when displaying an active record. Actually, for an active record with an End Date different from '9999-12-31', it is not possible to know whether the related record will be deleted (when the system reach the End Date) or if a future record exists and will be active, as a substitute for the active one.</p> <p>The use of the Planned Change flag is made to have information on the future of an active record.</p> <p>Mandatory</p> <p>Validation: [1..1]</p>
<RecSts>-</RecSts>	2x	Record Status	<p>Status of the record. List of values :</p> <p>"AC" for Active "FU" for Future "RE" for Rejected "AR" for Archived "AF" for Archived Future "IC" for In Change "DV" for Delivery (Technical) "ID" for In Deletion (Technical)</p> <p>For more information on status management, refer to the ICM UserHandBook.</p> <p>Mandatory</p> <p>Validation: [1..1]</p>
<FrstDt>-</FrstDt>	ISODate	First Activation Date	<p>Date within a particular calendar year represented by YYYY-MM-DD (ISO 8601). This date represents the first activation date of a functional item, such as a Participant. It is different from the modification date, which is the last date when a modification occurred.</p> <p>Mandatory</p> <p>Validation:</p>

name of attribute	format	short description	description
			[1..1]
<ModDt>--</ModDt>	ISODate	Modification Date	Date within a particular calendar year represented by YYYY-MM-DD (ISO 8601). This is the modification date of the related record. If the record has not been modified since its activation, the modification date is equal to the first activation date. Mandatory Validation: [1..1]
<EndDt>--</EndDt>	ISODate	End Date	Date within a particular calendar year represented by YYYY-MM-DD (ISO 8601). This is the end date of the related record. Value is equal to '9999-12-31' if no modification or deletion are foreseen for this record. Otherwise, the End Date takes the value of the modification date or date of the deletion. Mandatory Validation: [1..1]
</RecStsInf>		End of Record Status Information Mandatory	End of Record Status Information Validation: [1..1]
<EvtInf>		Event Information Mandatory	Event Information Validation: [1..1]
<EvtTp>--</EvtTp>	4x	Event Type Optional	Type of event. Max 4 characters, amongst a list of values. Validation: [0..1]
<EvtTm>--</EvtTm>	Time	Event Time Mandatory	Event Time with format HH:MM:SS Validation: [1..1]
<EvtDesc>--</EvtDesc>	35x	Event Description Mandatory	Specifies a character string with a maximum length of 35 characters. This is the description of an event. Validation: [1..1]
<EvtCtry>--</EvtCtry>	2x	Country Code for Event Mandatory	This is the country code attached to the related event. Validation: [1..1]
<Mdle>--</Mdle>	4c	Module	The list of allowed values is : "SSP" meaning that common SSP events are requested "RTGS" meaning that PM events are requested "HAM" meaning that HAM events are requested "RM" meaning that RM events are requested "SF" meaning that SF events are requested "CO1" meaning that CROSS events are requested "CIB" meaning that CRISP events are requested "CII" meaning that CRISP INVOICE events are requested "CA1" meaning that CRAKS1PM events are requested "CA3" meaning that CRAKS3 events are requested "ALL" meaning that all events are to be returned Module of the event

name of attribute	format	short description	description
		Mandatory	Validation: [1..1]
</EvtInf>		End of Event Information	End of Event Information
		Mandatory	Validation: [1..1]
</Evt>		End of TARGET Event	End of TARGET Event
		Mandatory	Validation: [1..1]
</BizRpt>		End of BusinessReport	End of BusinessReport
		Mandatory	Validation: [1..1]
<OprlErr>		OperationalError	Rule rationale: The message will contain either the information matching the search criteria of the related Get message or an error indication. Rule description: If BusinessReport is present then OperationalError is not allowed. If BusinessReport is not present, then OperationalError is mandatory. Separate Specification see UDFS books regarding error codes
		Mandatory	Validation: [1..1]
<Err>		Error handling	
		Mandatory	Validation: [1..1]
<Prtry>-</Prtry>	4x	Proprietary error code	Specification of the error, in free format.
		Mandatory	Validation: [1..1]
</Err>		End error handling	
		Mandatory	Validation: [1..1]
<Desc>-</Desc>	140x	Description	Specification of the error, in free format.
		Optional	Validation: [0..1]
</OprlErr>		End of Operational Error	End of Operational Error
		Mandatory	Validation: [1..1]
/xorBizRptOprlErr		End of choice	End of Choice
		Optional	Validation:
</ReturnEvent>		End of Message Type	End of Message Type for Static Data
		Mandatory	Validation: [1..1]
</SspPrtryDt>		End of SSP Proprietary Data	End of Root element for all SSP proprietary data

name of attribute	format	short description	description
		Mandatory	Validation: [1..1]
</Data>		End of Proprietary Data Mandatory	Validation: [1..1]
</PrtryData>		End of Proprietary Data Mandatory	End of Proprietary Data Validation: [1..1]
</PrtryMsg>		End proprietary message Mandatory	Validation:

Error Codes:

ReturnEvent_SD_1

Scope: This is the response to the XML request : GetEvent

Name Proprietary message	<PrtryMsg>
Message Header	<MsgHdr>
Message Identification	<MsgId>RETURNABC123</MsgId>
End of Message Header	</MsgHdr>
Related	<Rltd>
Reference	<Ref>ABC123</Ref>
End of Related	</Rltd>
Proprietary Data	<PrtryData>
Proprietary Data type	<Tp>ReturnEvent</Tp>
Proprietary Data	<Data>
SSP Proprietary Data	<SspPrtryDt>
Message Type	<ReturnEvent>
BusinessReport	<BizRpt>
TARGET Event	<Evt>
Record Status Information	<RecStsInf>
Planned Change	<PlnndChng>N</PlnndChng>
Record Status	<RecSts>AC</RecSts>
First Activation Date	<FrstDt>2006-10-10</FrstDt>
Modification Date	<ModDt>2012-10-22</ModDt>
End Date	<EndDt>9999-12-31</EndDt>
End of Record Status Information	</RecStsInf>
Event Information	<EvtInf>
Event Type	<EvtTp>TIME</EvtTp>
Event Time	<EvtTm>13:58:00.000+01:00</EvtTm>
Event Description	<EvtDesc>Start of Day</EvtDesc>
Country Code for Event	<EvtCtry>IE</EvtCtry>
Module	<Mdle>HAM</Mdle>
End of Event Information	</EvtInf>
End of TARGET Event	</Evt>
End of BusinessReport	</BizRpt>
End of Message Type	</ReturnEvent>
End of SSP Proprietary Data	</SspPrtryDt>
End of Proprietary Data	</Data>
End of Proprietary Data	</PrtryData>
End proprietary message	</PrtryMsg>

ReturnEvent_SD_2

Scope: This is the error response to the XML request : GetEvent

Name Proprietary message	<PrtryMsg>
Message Header	<MsgHdr>
Message Identification	<MsgId>RETURNABC123</MsgId>
End of Message Header	</MsgHdr>
Related	<Rltd>
Reference	<Ref>ABC123</Ref>
End of Related	</Rltd>
Proprietary Data	<PrtryData>
Proprietary Data type	<Tp>ReturnEvent</Tp>
Proprietary Data	<Data>
SSP Proprietary Data	<SspPrtryDt>
Message Type	<ReturnEvent>
OperationalError	<OpriErr>
Error handling	<Err>
Proprietary error code	<Prtry>S100</Prtry>
End error handling	</Err>
Description	<Desc>No data available for selected criteria - No event data found</Desc>
End of Operational Error	</OpriErr>
End of Message Type	</ReturnEvent>
End of SSP Proprietary Data	</SspPrtryDt>
End of Proprietary Data	</Data>
End of Proprietary Data	</PrtryData>
End proprietary message	</PrtryMsg>

6. 5.40 ReturnGOA

SSP Proprietary Messages

ReturnGOA_SD

Scope: This is the response to the XML request : GetGOA

<camt.998.001.xx>

Structure:

Name Proprietary message	<PrtryMsg>
Message Header	<MsgHdr>
Message Identification	<MsgId></MsgId>
End of Message Header	</MsgHdr>
Related	<Rltd>
Reference	<Ref></Ref>
End of Related	</Rltd>
Proprietary Data	<PrtryData>
Proprietary Data type	<Tp>ReturnGOA</Tp>
Proprietary Data	<Data>
SSP Proprietary Data	<SspPrtryDt>
Message Type	<ReturnGOA>
Choice amongst	<xorBizRptOprlErr>
BusinessReport	<BizRpt>
Group Of Account	<GOA>
Record Status Information	<RecStsInf>
Planned Change	<PlndChng></PlndChng>
Record Status	<RecSts></RecSts>
First Activation Date	<FrstDt></FrstDt>
Modification Date	<ModDt></ModDt>
End Date	<EndDt></EndDt>
End of Record Status Information	</RecStsInf>
Group of Account Information	<GOAInf>
Group of Account Name	<GOANm></GOANm>
Group of Accounts ID	<GOAId></GOAId>
Group of Account Type	<GOATp></GOATp>
Responsible CB	<RspnsblCntrlBk></RspnsblCntrlBk>
End of GOA Information	</GOAInf>
Consolidated Information	<CnsltdInf>
Group of Account Name	<GOANm></GOANm>
Group of Accounts ID	<GOAId></GOAId>
End of Consolidated Information	</CnsltdInf>
Banking Group Monitoring	<BGM>
Group of Account Name	<GOANm></GOANm>
Group of Accounts ID	<GOAId></GOAId>
End of Banking Group Monitoring	</BGM>
Selected for CB monitoring list	<SlctCBML></SlctCBML>
List Of RTGS Account	<ListRTGSAcct>
RTGS Account	<RTGSAcct>
BIC	<BIC></BIC>
Account Name	<AcctNm></AcctNm>
Account Number	<AcctNb></AcctNb>
Flag Is a Sub Account	<IsSubAcct></IsSubAcct>
Virtual Account	<VrtlAcct></VrtlAcct>

Is the Main Account	<IsMainAcct></IsMainAcct>
End of RTGS Account	</RTGSAcct>
End of List Of RTGS Account	</ListRTGSAcct>
End of GOA	</GOA>
End of BusinessReport	</BizRpt>
OperationalError	<OprlErr>
Error handling	<Err>
Proprietary error code	<Prtry></Prtry>
End error handling	</Err>
Description	<Desc></Desc>
End of Operational Error	</OprlErr>
End of choice	</xorBizRptOprlErr>
End of Message Type	</ReturnGOA>
End of SSP Proprietary Data	</SspPrtryDt>
End of Proprietary Data	</Data>
End of Proprietary Data	</PrtryData>
End proprietary message	</PrtryMsg>

Attributes:

name of attribute	format	short description	description
<PrtryMsg>		Name Proprietary message Mandatory	Validation: [1..1]
<MsgHdr>		Message Header Mandatory	Set of characteristics specific to the message Validation: [1..1]
<MsgId></MsgId>	35x	Message Identification Mandatory	Message Identification Validation: [1..1]
</MsgHdr>		End of Message Header Mandatory	Validation: [1..1]
<Rltd>		Related Optional	References a previously received message. Validation: [0..1]
<Ref></Ref>	35x	Reference Mandatory	Unique and unambiguous reference Validation: [1..1]
</Rltd>		End of Related Optional	End of Related Validation: [0..1]
<PrtryData>		Proprietary Data Mandatory	Proprietary Data Validation: [1..1]
<Tp></Tp>	35x	Proprietary Data type Mandatory	Proprietary Data type defines the Type of the free format XML Validation: [1..1]
<Data>		Proprietary Data Mandatory	Proprietary data content Validation: [1..1]
<SspPrtryDt>		SSP Proprietary Data Mandatory	Root element for all SSP proprietary data Validation: [1..1]
<ReturnGOA>		Message Type Mandatory	Message Type for Static Data Validation: [1..1]
xorBizRptOpriErr		Choice amongst Optional	Choice amongst xorBizRptOpriErr (Type: xor) Validation:

name of attribute	format	short description	description
<BizRpt>		BusinessReport	<p>BusinessReport</p> <p>Rule rationale: The message will contain either the information matching the search criteria of the related Get message or an error indication.</p> <p>Rule description: If BusinessReport is present then OperationalError is not allowed. If BusinessReport is not present, then OperationalError is mandatory.</p> <p>Mandatory</p> <p>Validation: [1..1]</p>
<GOA>		Group Of Account	<p>Group Of Account</p> <p>Mandatory</p> <p>Validation: [1..n]</p>
<RecStsInf>		Record Status Information	<p>Record Status Information</p> <p>Mandatory</p> <p>Validation: [1..1]</p>
<PlnndChng>-</PlnndChng>	1!a	Planned Change	<p>Information on record regarding the presence of a future record. Values may be :</p> <p>"N" if no future record is present "D" if the record will be deleted "M" if a future record exists</p> <p>Note : the Planned Change flag has been added in order to help users when displaying an active record. Actually, for an active record with an End Date different from '9999-12-31', it is not possible to know whether the related record will be deleted (when the system reach the End Date) or if a future record exists and will be active, as a substitute for the active one.</p> <p>The use of the Planned Change flag is made to have information on the future of an active record.</p> <p>Mandatory</p> <p>Validation: [1..1]</p>
<RecSts>-</RecSts>	2x	Record Status	<p>Status of the record. List of values :</p> <p>"AC" for Active "FU" for Future "RE" for Rejected "AR" for Archived "AF" for Archived Future "IC" for In Change "DV" for Delivery (Technical) "ID" for In Deletion (Technical)</p> <p>For more information on status management, refer to the ICM UserHandBook.</p> <p>Mandatory</p> <p>Validation: [1..1]</p>
<FrstDt>-</FrstDt>	ISODate	First Activation Date	<p>Date within a particular calendar year represented by YYYY-MM-DD (ISO 8601). This date represents the first activation date of a functional item, such as a Participant. It is different from the modification date, which is the last date when a modification occurred.</p> <p>Mandatory</p> <p>Validation: [1..1]</p>

name of attribute	format	short description	description
<ModDt>-</ModDt>	ISODate	Modification Date	Date within a particular calendar year represented by YYYY-MM-DD (ISO 8601). This is the modification date of the related record. If the record has not been modified since its activation, the modification date is equal to the first activation date. Mandatory Validation: [1..1]
<EndDt>-</EndDt>	ISODate	End Date	Date within a particular calendar year represented by YYYY-MM-DD (ISO 8601). This is the end date of the related record. Value is equal to '9999-12-31' if no modification or deletion are foreseen for this record. Otherwise, the End Date takes the value of the modification date or date of the deletion. Mandatory Validation: [1..1]
</RecStsInf>		End of Record Status Information Mandatory	End of Record Status Information Validation: [1..1]
<GOAInf>		Group of Account Information Mandatory	Group of Account Information Validation: [1..1]
<GOANm>-</GOANm>	35x	Group of Account Name Mandatory	Group of Account Name Validation: [1..1]
<GOAId>-</GOAId>	12x	Group of Accounts ID Mandatory	Group of Accounts ID. Length 12 characters. Validation: [1..1]
<GOATp>-</GOATp>	2!a	Group of Account Type Mandatory	Type of Group of Account. Values accepted are : "CI" for Consolidated Information Group of Accounts "VA" for Virtual Group of Accounts "BG" for Banking Group Monitoring (only for CB and SSP users) "AL" for getting all type of Group of Accounts (used for 'Get' XML Message). Validation: [1..1]
<RspnsblCntrlBk>-</RspnsblCntrlBk>	2!c	Responsible CB Mandatory	ISO Country Code of the Responsible Central Bank. Validation: [1..1]
</GOAInf>		End of GOA Information Mandatory	End of GOA Information Validation: [1..1]
<CnsltdInf>		Consolidated Information Optional	Consolidated Information Group of Account Validation: [0..1]

name of attribute	format	short description	description
<GOANm>-</GOANm>	35x	Group of Account Name Mandatory	Group of Account Name Validation: [1..1]
<GOAId>-</GOAId>	12x	Group of Accounts ID Mandatory	Group of Accounts ID. Lenght 12 characters. Validation: [1..1]
</CnsltdInf>		End of Consolidated Information Optional	End of Consolidated Information Validation: [0..1]
<BGM>		Banking Group Monitoring Optional	Banking Group Monitoring Validation: [0..1]
<GOANm>-</GOANm>	35x	Group of Account Name Mandatory	Group of Account Name Validation: [1..1]
<GOAId>-</GOAId>	12x	Group of Accounts ID Mandatory	Group of Accounts ID. Lenght 12 characters. Validation: [1..1]
</BGM>		End of Banking Group Monitoring Optional	End of Banking Group Monitoring Validation: [0..1]
<SlctCBML>-</SlctCBML>	1!a	Selected for CB monitoring list Optional	Selected for CB monitoring list A flag with two values : 'Y' or 'N'. This flag is used to indicate whether the GoA is selected for the CB monitoring list or not. Only for CB and SSP users. Validation: [0..1]
<ListRTGSAcct>		List Of RTGS Account Optional	List Of RTGS Account Validation: [0..1]
<RTGSAcct>		RTGS Account Optional	RTGS Account Validation: [0..n]
<BIC>-</BIC>	4!a2!a2!c3!c	BIC Optional	A code allocated to a financial institution by a Registration Authority under an international identification scheme, as described in the latest edition of the international standard ISO 9362 "Banking - Banking telecommunication messages - Bank identifier codes". BIC 11 of the RTGS account Holder (BIC Participant). Validation: [0..1]
<AcctNm>-</AcctNm>	35x	Account Name Optional	Account Name Validation:

name of attribute	format	short description	description
			[0..1]
<AcctNb>-</AcctNb>	2!c32x	Account Number	Account Number. Length 34 characters. The first two characters represent the country code of the responsible CB.
		Optional	Validation: [0..1]
<IsSubAcct>-</IsSubAcct>	1!a	Flag Is a Sub Account	A flag with two values : 'Y' or 'N'. This flag indicates whether an account is (value 'Y') or not (value 'N') a sub account.
		Optional	Validation: [0..1]
<VrtlAcct>-</VrtlAcct>	12x	Virtual Account	Virtual Group of Accounts ID Present only if the related participant is also part of a Virtual Group of Accounts.
		Optional	Validation: [0..1]
<IsMainAcct>-</IsMainAcct>	1!a	Is the Main Account	A flag with two values : 'Y' or 'N'. This flag is used to indicate whether an RTGS Account is the main account of a Group of Accounts or not.
		Optional	Validation: [0..1]
</RTGSAcct>		End of RTGS Account	End of RTGS Account
		Optional	Validation: [0..n]
</ListRTGSAcct>		End of List Of RTGS Account	End of List Of RTGS Account
		Optional	Validation: [0..n]
</GOA>		End of GOA	End of GOA
		Mandatory	Validation: [1..1]
</BizRpt>		End of BusinessReport	End of BusinessReport
		Mandatory	Validation: [1..1]
<OprlErr>		OperationalError	Rule rationale: The message will contain either the information matching the search criteria of the related Get message or an error indication. Rule description: If BusinessReport is present then OperationalError is not allowed. If BusinessReport is not present, then OperationalError is mandatory. Separate Specification see UDFS books regarding error codes
		Mandatory	Validation: [1..1]
<Err>		Error handling	
		Mandatory	Validation: [1..1]

name of attribute	format	short description	description
<Prtry>-</Prtry>	4x	Proprietary error code	Specification of the error, in free format.
		Mandatory	Validation: [1..1]
</Err>		End error handling	
		Mandatory	Validation: [1..1]
<Desc>-</Desc>	140x	Description	Specification of the error, in free format.
		Optional	Validation: [0..1]
</OprlErr>		End of Operational Error	End of Operational Error
		Mandatory	Validation: [1..1]
/xorBizRptOprlErr		End of choice	End of Choice
		Optional	Validation:
</ReturnGOA>		End of Message Type	End of Message Type for Static Data
		Mandatory	Validation: [1..1]
</SspPrtryDt>		End of SSP Proprietary Data	End of Root element for all SSP proprietary data
		Mandatory	Validation: [1..1]
</Data>		End of Proprietary Data	
		Mandatory	Validation: [1..1]
</PrtryData>		End of Proprietary Data	End of Proprietary Data
		Mandatory	Validation: [1..1]
</PrtryMsg>		End proprietary message	
		Mandatory	Validation:

Error Codes:

ReturnGOA_SD_1

Scope: Response to the XML GetGOA request for the FR Active GOAs of type CI

Name Proprietary message	<PrtryMsg>
Message Header	<MsgHdr>
Message Identification	<MsgId>13588633243951098206530</MsgId>
End of Message Header	</MsgHdr>
Related	<Rltd>
Reference	<Ref>GETGOA20130118</Ref>
End of Related	</Rltd>
Proprietary Data	<PrtryData>
Proprietary Data type	<Tp>ReturnGOA</Tp>
Proprietary Data	<Data>
SSP Proprietary Data	<SspPrtryDt>
Message Type	<ReturnGOA>
BusinessReport	<BizRpt>
Group Of Account	<GOA>
Record Status Information	<RecStsInf>
Planned Change	<PlnndChng>N</PlnndChng>
Record Status	<RecSts>AC</RecSts>
First Activation Date	<FrstDt>2008-06-25</FrstDt>
Modification Date	<ModDt>2012-08-31</ModDt>
End Date	<EndDt>9999-12-31</EndDt>
End of Record Status Information	</RecStsInf>
Group of Account Information	<GOAInf>
Group of Account Name	<GOANm>CRMFRCl1 modif</GOANm>
Group of Accounts ID	<GOAId>CRMFRCl1</GOAId>
Group of Account Type	<GOATp>CI</GOATp>
Responsible CB	<RspnsblCntrlBk>FR</RspnsblCntrlBk>
End of GOA Information	</GOAInf>
List Of RTGS Account	<ListRTGSAcct>
RTGS Account	<RTGSAcct>
BIC	<BIC>SDMFRCRM145</BIC>
Account Number	<AcctNb>FRSDMFRCRM145</AcctNb>
Flag Is a Sub Account	<IsSubAcct>N</IsSubAcct>
Virtual Account	<VrtlAcct>GOAFRTEST02</VrtlAcct>
Is the Main Account	<IsMainAcct>N</IsMainAcct>
End of RTGS Account	</RTGSAcct>
End of List Of RTGS Account	</ListRTGSAcct>
End of GOA	</GOA>
End of BusinessReport	</BizRpt>
End of Message Type	</ReturnGOA>
End of SSP Proprietary Data	</SspPrtryDt>
End of Proprietary Data	</Data>
End of Proprietary Data	</PrtryData>
End proprietary message	</PrtryMsg>

ReturnGOA_SD_2

Scope: Response to the XML GetGOA request for the GOA GOAFRBK1

Name Proprietary message	<PrtryMsg>
Message Header	<MsgHdr>
Message Identification	<Msgld>13587843599142025949824</Msgld>
End of Message Header	</MsgHdr>
Related	<Rltd>
Reference	<Ref>GETGOA20130121</Ref>
End of Related	</Rltd>
Proprietary Data	<PrtryData>
Proprietary Data type	<Tp>ReturnGOA</Tp>
Proprietary Data	<Data>
SSP Proprietary Data	<SspPrtryDt>
Message Type	<ReturnGOA>
BusinessReport	<BizRpt>
Group Of Account	<GOA>
Record Status Information	<RecStsInf>
Planned Change	<PlndChng>N</PlndChng>
Record Status	<RecSts>AC</RecSts>
First Activation Date	<FrstDt>2010-08-03</FrstDt>
Modification Date	<ModDt>2012-04-30</ModDt>
End Date	<EndDt>9999-12-31</EndDt>
End of Record Status Information	</RecStsInf>
Group of Account Information	<GOAInf>
Group of Account Name	<GOANm>GOAFRBK1</GOANm>
Group of Accounts ID	<GOAId>GOAFRBK1</GOAId>
Group of Account Type	<GOATp>CI</GOATp>
Responsible CB	<RspnsblCntrlBk>FR</RspnsblCntrlBk>
End of GOA Information	</GOAInf>
List Of RTGS Account	<ListRTGSAcct>
RTGS Account	<RTGSAcct>
BIC	<BIC>SDMFRCRM125</BIC>
Account Name	<AcctNm>SDMFRCRM125sub</AcctNm>
Account Number	<AcctNb>FRSDMFRCRM125sub</AcctNb>
Flag Is a Sub Account	<IsSubAcct>N</IsSubAcct>
Is the Main Account	<IsMainAcct>N</IsMainAcct>
End of RTGS Account	</RTGSAcct>
RTGS Account	<RTGSAcct>
BIC	<BIC>SDMESCRM009</BIC>
Account Name	<AcctNm>SDMESCRM009sub1</AcctNm>
Account Number	<AcctNb>ESSDMESCRM009sub1</AcctNb>
Flag Is a Sub Account	<IsSubAcct>N</IsSubAcct>
Is the Main Account	<IsMainAcct>N</IsMainAcct>
End of RTGS Account	</RTGSAcct>
End of List Of RTGS Account	</ListRTGSAcct>
End of GOA	</GOA>
End of BusinessReport	</BizRpt>
End of Message Type	</ReturnGOA>
End of SSP Proprietary Data	</SspPrtryDt>
End of Proprietary Data	</Data>
End of Proprietary Data	</PrtryData>

End proprietary message

</PrtryMsg>

ReturnGOA_SD_3

Scope: Error message Response to an XML GetGOA request with an irrelevant period search

Name Proprietary message	<PrtryMsg>
Message Header	<MsgHdr>
Message Identification	<MsgId>1358784282314930540977</MsgId>
End of Message Header	</MsgHdr>
Related	<Rltd>
Reference	<Ref>GETGOA20130122</Ref>
End of Related	</Rltd>
Proprietary Data	<PrtryData>
Proprietary Data type	<Tp>ReturnGOA</Tp>
Proprietary Data	<Data>
SSP Proprietary Data	<SspPrtryDt>
Message Type	<ReturnGOA>
OperationalError	<OprlErr>
Error handling	<Err>
Proprietary error code	<Prtry>S100/Prtry>
End error handling	</Err>
Description	<Desc>No data available for selected criteria - Result was empty!</Desc>
End of Operational Error	</OprlErr>
End of Message Type	</ReturnGOA>
End of SSP Proprietary Data	</SspPrtryDt>
End of Proprietary Data	</Data>
End of Proprietary Data	</PrtryData>

6. 5.41 ReturnHAMAccount

SSP Proprietary Messages

ReturnHAMAccount_SD

Scope: This is the response to the XML request : GetHAMAccount

<camt.998.001.xx>

Structure:

Name Proprietary message	<PrtryMsg>
Message Header	<MsgHdr>
Message Identification	<MsgId></MsgId>
End of Message Header	</MsgHdr>
Related	<Rltd>
Reference	<Ref></Ref>
End of Related	</Rltd>
Proprietary Data	<PrtryData>
Proprietary Data type	<Tp>ReturnHamAccount</Tp>
Proprietary Data	<Data>
SSP Proprietary Data	<SspPrtryDt>
Message Type	<ReturnHamAccount>
Choice amongst	<xorBizRptOprlErr>
BusinessReport	<BizRpt>
HAM Account	<HamAccount>
Participant Information	<PtcptInf>
Participant Name1	<PtcptNm1></PtcptNm1>
BIC	<BIC></BIC>
BIC Addressee	<BICAddss></BICAddss>
National Sorting Code	<NSC></NSC>
End of Participant Information	</PtcptInf>
Record Status Information	<RecStsInf>
Planned Change	<PlnndChng></PlnndChng>
Record Status	<RecSts></RecSts>
First Activation Date	<FrstDt></FrstDt>
Modification Date	<ModDt></ModDt>
End Date	<EndDt></EndDt>
End of Record Status Information	</RecStsInf>
Account Information	<AcctInf>
HAM Account Number	<HamAcctNb></HamAcctNb>
HAM Account Type	<HamAcctTp></HamAcctTp>
Notification BIC	<NtfctnBIC></NtfctnBIC>
Accept MT202 Notify	<Ntfctn202LqdyTrf></Ntfctn202LqdyTrf>
Accept MT900 Notify	<Ntfctn900></Ntfctn900>
Accept MT910 Notify	<Ntfctn910></Ntfctn910>
Balance Report	<BalRpt></BalRpt>
End of Account Information	</AcctInf>
CoManager Information	<CmngInf>
Co Manager Name	<CmngNm></CmngNm>
BIC Co Manager	<CmngBIC></CmngBIC>
CB Responsible	<Ctry></Ctry>
End of CoManager Information	</CmngInf>
End of HAM Account	</HamAccount>
End of BusinessReport	</BizRpt>

OperationalError						<OprlErr>
Error handling						<Err>
Proprietary error code						<Prtry></Prtry>
End error handling						</Err>
Description						<Desc></Desc>
End of Operational Error						</OprlErr>
End of choice						</xorBizRptOprlErr>
End of Message Type						</ReturnHamAccount>
End of SSP Proprietary Data						</SspPrtryDt>
End of Proprietary Data						</Data>
End of Proprietary Data						</PrtryData>
End proprietary message						</PrtryMsg>

Attributes:

name of attribute	format	short description	description
<PrtryMsg>		Name Proprietary message Mandatory	Validation: [1..1]
<MsgHdr>		Message Header Mandatory	Set of characteristics specific to the message Validation: [1..1]
<MsgId>-</MsgId>	35x	Message Identification Mandatory	Message Identification Validation: [1..1]
</MsgHdr>		End of Message Header Mandatory	Validation: [1..1]
<Rltd>		Related Optional	References a previously received message. Validation: [0..1]
<Ref>-</Ref>	35x	Reference Mandatory	Unique and unambiguous reference Validation: [1..1]
</Rltd>		End of Related Optional	End of Related Validation: [0..1]
<PrtryData>		Proprietary Data Mandatory	Proprietary Data Validation: [1..1]
<Tp>-</Tp>	35x	Proprietary Data type Mandatory	Proprietary Data type defines the Type of the free format XML Validation: [1..1]
<Data>		Proprietary Data Mandatory	Proprietary data content Validation: [1..1]
<SspPrtryDt>		SSP Proprietary Data Mandatory	Root element for all SSP proprietary data Validation: [1..1]
<ReturnHamAccount>		Message Type Mandatory	Message Type for Static Data Validation: [1..1]
xorBizRptOpriErr		Choice amongst Optional	Choice amongst xorBizRptOpriErr (Type: xor) Validation:

name of attribute	format	short description	description
<BizRpt>		BusinessReport	BusinessReport Rule rationale: The message will contain either the information matching the search criteria of the related Get message or an error indication. Rule description: If BusinessReport is present then OperationalError is not allowed. If BusinessReport is not present, then OperationalError is mandatory.
		Mandatory	Validation: [1..1]
<HamAccount>		HAM Account	HAM Account
		Mandatory	Validation: [1..n]
<PtcptInf>		Participant Information	Participant Information
		Mandatory	Validation: [1..1]
<PtcptNm1>-</PtcptNm1>	35x	Participant Name1	Participant Name, first line.
		Mandatory	Validation: [1..1]
<BIC>-</BIC>	4!a2!a2!c3!c	BIC	A code allocated to a financial institution by a Registration Authority under an international identification scheme, as described in the latest edition of the international standard ISO 9362 "Banking - Banking telecommunication messages - Bank identifier codes". For this case, this is the BIC 11 of the participant, owner of the HAM Account.
		Optional	Validation: [0..1]
<BICAddss>-</BICAddss>	4!a2!a2!c3!c]	BIC Addressee	A code allocated to a financial institution by a Registration Authority under an international identification scheme, as described in the latest edition of the international standard ISO 9362 "Banking - Banking telecommunication messages - Bank identifier codes". In this case, this is the Addressee BIC (BIC 11).
		Optional	Validation: [0..1]
<NSC>-</NSC>	15n	National Sorting Code	Code present in the BIC DATA +. Character string with a max length of 15 characters.
		Optional	Validation: [0..1]
</PtcptInf>		End of Participant Information	End of Participant Information
		Mandatory	Validation: [1..1]
<RecStsInf>		Record Status Information	Record Status Information
		Mandatory	Validation: [1..1]
<PlndChng>-</PlndChng>	1!a	Planned Change	Information on record regarding the presence of a future

name of attribute	format	short description	description
			<p>record. Values may be :</p> <p>"N" if no future record is present "D" if the record will be deleted "M" if a future record exists</p> <p>Note : the Planned Change flag has been added in order to help users when displaying an active record. Actually, for an active record with an End Date different from '9999-12-31', it is not possible to know whether the related record will be deleted (when the system reach the End Date) or if a future record exists and will be active, as a substitute for the active one.</p> <p>The use of the Planned Change flag is made to have information on the future of an active record.</p> <p style="text-align: right;">Mandatory</p> <p style="text-align: right;">Validation: [1..1]</p>
<RecSts>-</RecSts>	2x	Record Status	<p>Status of the record. List of values :</p> <p>"AC" for Active "FU" for Future "RE" for Rejected "AR" for Archived "AF" for Archived Future "IC" for In Change "DV" for Delivery (Technical) "ID" for In Deletion (Technical)</p> <p>For more information on status management, refer to the ICM UserHandBook.</p> <p style="text-align: right;">Mandatory</p> <p style="text-align: right;">Validation: [1..1]</p>
<FrstDt>-</FrstDt>	ISODate	First Activation Date	<p>Date within a particular calendar year represented by YYYY-MM-DD (ISO 8601). This date represents the first activation date of a functional item, such as a Participant. It is different from the modification date, which is the last date when a modification occurred.</p> <p style="text-align: right;">Mandatory</p> <p style="text-align: right;">Validation: [1..1]</p>
<ModDt>-</ModDt>	ISODate	Modification Date	<p>Date within a particular calendar year represented by YYYY-MM-DD (ISO 8601).</p> <p>This is the modification date of the related record. If the record has not been modified since its activation, the modification date is equal to the first activation date.</p> <p style="text-align: right;">Mandatory</p> <p style="text-align: right;">Validation: [1..1]</p>
<EndDt>-</EndDt>	ISODate	End Date	<p>Date within a particular calendar year represented by YYYY-MM-DD (ISO 8601).</p> <p>This is the end date of the related record. Value is equal to '9999-12-31' if no modification or deletion are foreseen for this record. Otherwise, the End Date takes the value of the modification date or date of the deletion.</p> <p style="text-align: right;">Optional</p> <p style="text-align: right;">Validation: [0..1]</p>
</RecStsInf>		End of Record Status Information	<p>End of Record Status Information</p> <p style="text-align: right;">Mandatory</p> <p style="text-align: right;">Validation:</p>

name of attribute	format	short description	description
			[1..1]
<AcctInf>		Account Information	Account Information
		Mandatory	Validation: [1..1]
<HamAcctNb></HamAcctNb>	2!c32x	HAM Account Number	Account Number. Length 34 characters. The first two characters represent the country code of the responsible CB. The Account Number is unique within the HAM.
		Mandatory	Validation: [1..1]
<HamAcctTp></HamAcctTp>	3x	HAM Account Type	Indicates the type of HAM Account. Values may be : "SU" for normal HAM Account "CB" for CB HAM Account "CU" for CB Customer Account "LB" for CB Customer Liquidity Bridge Account (technical) "SFI" for Standing Facilities Interests Account (technical) "RIP" for RM interests and penalty Account (technical) "HAI" for HAM Interests Account (technical) "T2F" for Target 2 Fees Account (technical)
		Mandatory	Validation: [1..1]
<NtfctnBIC></NtfctnBIC>	4!a2!a2!c[3!c]	Notification BIC	A code allocated to a financial institution by a Registration Authority under an international identification scheme, as described in the latest edition of the international standard ISO 9362 "Banking - Banking telecommunication messages - Bank identifier codes". In this case, this is the BIC used for all notification messages in HAM.
		Optional	Validation: [0..1]
<Ntfctn202LqdyTrf></Ntfctn202LqdyTrf>	1!a	Accept MT202 Notify	For HAM Account in case of liquidity transfer : A flag with two values : 'Y' or 'N'. This flag indicates that the participant has chosen to receive MT202 in case of liquidity transfer
		Mandatory	Validation: [1..1]
<Ntfctn900></Ntfctn900>	1!a	Accept MT900 Notify	For HAM Account : A flag with two values : 'Y' or 'N'. This flag indicates that the participant has chosen to receive MT900 for each debit
		Mandatory	Validation: [1..1]
<Ntfctn910></Ntfctn910>	1!a	Accept MT910 Notify	A flag with two values : 'Y' or 'N'. This flag indicates that the participant has chosen to receive MT910 for each credit.
		Mandatory	Validation: [1..1]
<BalRpt></BalRpt>	3!n	Balance Report	This is the Swift message type for Balance Report. List of values : "940", "950" or "none"
		Mandatory	Validation: [0..1]

name of attribute	format	short description	description
</AcctInf>		End of Account Information	End of Account Information
		Mandatory	Validation: [1..1]
<CmngInf>		CoManager Information	CoManager Information
		Optional	Validation: [0..1]
<CmngNm>-</CmngNm>	35x	Co Manager Name	Name of the Co-manager (35x).
		Optional	Validation: [0..1]
<CmngBIC>-</CmngBIC>	11x	BIC Co Manager	A code allocated to a financial institution by a Registration Authority under an international identification scheme, as described in the latest edition of the international standard ISO 9362 "Banking - Banking telecommunication messages - Bank identifier codes". In this case, this is the BIC 11 of the Co Manager (Participant BIC).
		Optional	Validation: [0..1]
<Ctry>-</Ctry>	2!c	CB Responsible	Country Code of the Responsible CB.
		Optional	Validation: [0..1]
</CmngInf>		End of CoManager Information	End of CoManager Information
		Optional	Validation: [0..1]
</HamAccount>		End of HAM Account	End of HAM Account
		Mandatory	Validation: [1..1]
</BizRpt>		End of BusinessReport	End of BusinessReport
		Mandatory	Validation: [1..1]
<OpriErr>		OperationalError	Rule rationale: The message will contain either the information matching the search criteria of the related Get message or an error indication. Rule description: If BusinessReport is present then OperationalError is not allowed. If BusinessReport is not present, then OperationalError is mandatory. Separate Specification see UDFS books regarding error codes
		Mandatory	Validation: [1..1]
<Err>		Error handling	
		Mandatory	Validation: [1..1]
<Prtry>-</Prtry>	4x	Proprietary error code	Specification of the error, in free format.

name of attribute	format	short description	description
		Mandatory	Validation: [1..1]
</Err>		End error handling Mandatory	Validation: [1..1]
<Desc>-</Desc>	140x	Description Optional	Specification of the error, in free format. Validation: [0..1]
</OprlErr>		End of Operational Error Mandatory	End of Operational Error Validation: [1..1]
/xorBizRptOprlErr		End of choice Optional	End of Choice Validation:
</ReturnHamAccount>		End of Message Type Mandatory	End of Message Type for Static Data Validation: [1..1]
</SspPrtryDt>		End of SSP Proprietary Data Mandatory	End of Root element for all SSP proprietary data Validation: [1..1]
</Data>		End of Proprietary Data Mandatory	Validation: [1..1]
</PrtryData>		End of Proprietary Data Mandatory	End of Proprietary Data Validation: [1..1]
</PrtryMsg>		End proprietary message Mandatory	Validation:

Error Codes:

ReturnHamAccount_SD_1

Scope: Response to the XML GetHamAccount

Name Proprietary message	<PrtryMsg>
Message Header	<MsgHdr>
Message Identification	<MsgId>RETURNABC123</MsgId>
End of Message Header	</MsgHdr>
Related	<Rltd>
Reference	<Ref>ABC123</Ref>
End of Related	</Rltd>
Proprietary Data	<PrtryData>
Proprietary Data type	<Tp>ReturnHamAccount</Tp>
Proprietary Data	<Data>
SSP Proprietary Data	<SspPrtryDt>
Message Type	<ReturnHamAccount>
BusinessReport	<BizRpt>
HAM Account	<HamAccount>
Participant Information	<PtcptInf>
Participant Name1	<PtcptNm1>ASI Settlement Bank ZYAJFRT0HS1</PtcptNm1>
BIC	<BIC>ZYAJFRT0HS1</BIC>
BIC Addressee	<BICAddss>ZYAJFRT0HS1</BICAddss>
End of Participant Information	</PtcptInf>
Record Status Information	<RecStsInf>
Planned Change	<PlndChng>N</PlndChng>
Record Status	<RecSts>AC</RecSts>
First Activation Date	<FrstDt>2012-03-12</FrstDt>
Modification Date	<ModDt>2012-03-12</ModDt>
End Date	<EndDt>9999-12-31</EndDt>
End of Record Status Information	</RecStsInf>
Account Information	<AcctInf>
HAM Account Number	<HamAcctNb>ESZYAJFRT0HS1</HamAcctNb>
HAM Account Type	<HamAcctTp>SU</HamAcctTp>
Accept MT202 Notify	<Ntfctn202LqdyTrf>N</Ntfctn202LqdyTrf>
Accept MT900 Notify	<Ntfctn900>Y</Ntfctn900>
Accept MT910 Notify	<Ntfctn910>Y</Ntfctn910>
Balance Report	<BalRpt>940</BalRpt>
End of Account Information	</AcctInf>
End of HAM Account	</HamAccount>
End of BusinessReport	</BizRpt>
End of Message Type	</ReturnHamAccount>
End of SSP Proprietary Data	</SspPrtryDt>
End of Proprietary Data	</Data>
End of Proprietary Data	</PrtryData>
End proprietary message	</PrtryMsg>

ReturnHamAccount_SD_2

Scope: Response to the XML GetHamAccount asking for a co-managed HAM account

Name Proprietary message	<PrtryMsg>
Message Header	<MsgHdr>
Message Identification	<MsgId>RETURNABC123</MsgId>
End of Message Header	</MsgHdr>
Related	<Rltd>
Reference	<Ref>ABC123</Ref>
End of Related	</Rltd>
Proprietary Data	<PrtryData>
Proprietary Data type	<Tp>ReturnHamAccount</Tp>
Proprietary Data	<Data>
SSP Proprietary Data	<SspPrtryDt>
Message Type	<ReturnHamAccount>
BusinessReport	<BizRpt>
HAM Account	<HamAccount>
Participant Information	<PtcptInf>
Participant Name1	<PtcptNm1>SDMFESPA001 UPD</PtcptNm1>
BIC	<BIC>SDMFESPA001</BIC>
BIC Addressee	<BICAddss>SDMFESPA001</BICAddss>
End of Participant Information	</PtcptInf>
Record Status Information	<RecStsInf>
Planned Change	<PlnndChng>N</PlnndChng>
Record Status	<RecSts>AC</RecSts>
First Activation Date	<FrstDt>2008-12-01</FrstDt>
Modification Date	<ModDt>2012-04-18</ModDt>
End Date	<EndDt>9999-12-31</EndDt>
End of Record Status Information	</RecStsInf>
Account Information	<AcctInf>
HAM Account Number	<HamAcctNb>ESSDMFESPA001</HamAcctNb>
HAM Account Type	<HamAcctTp>SU</HamAcctTp>
Notification BIC	<NtfctnBIC>SDMFESPA004</NtfctnBIC>
Accept MT202 Notify	<Ntfctn202LqdyTrf>Y</Ntfctn202LqdyTrf>
Accept MT900 Notify	<Ntfctn900>N</Ntfctn900>
Accept MT910 Notify	<Ntfctn910>N</Ntfctn910>
End of Account Information	</AcctInf>
CoManager Information	<CmngInf>
Co Manager Name	<CmngNm>12345678901234567890123456789012345</CmngNm>
BIC Co Manager	<CmngBIC>ZYAJFRT0BS1</CmngBIC>
CB Responsible	<Ctry>BE</Ctry>
End of CoManager Information	</CmngInf>
End of HAM Account	</HamAccount>
End of BusinessReport	</BizRpt>
End of Message Type	</ReturnHamAccount>
End of SSP Proprietary Data	</SspPrtryDt>
End of Proprietary Data	</Data>
End of Proprietary Data	</PrtryData>
End proprietary message	</PrtryMsg>

ReturnHamAccount_SD_3

Scope: Error message Response to an XML GetHamAccount

Name Proprietary message	<PrtryMsg>
Message Header	<MsgHdr>
Message Identification	<MsgId>RETURNABC123</MsgId>
End of Message Header	</MsgHdr>
Related	<Rltd>
Reference	<Ref>ABC123</Ref>
End of Related	</Rltd>
Proprietary Data	<PrtryData>
Proprietary Data type	<Tp>ReturnHamAccount</Tp>
Proprietary Data	<Data>
SSP Proprietary Data	<SspPrtryDt>
Message Type	<ReturnHamAccount>
OperationalError	<OprlErr>
Error handling	<Err>
Proprietary error code	<Prtry>S100</Prtry>
End error handling	</Err>
Description	<Desc>No data available for selected criteria - No record for a ham owned by ZYAJFRT0BS1</Desc>
End of Operational Error	</OprlErr>
End of Message Type	</ReturnHamAccount>
End of SSP Proprietary Data	</SspPrtryDt>
End of Proprietary Data	</Data>
End of Proprietary Data	</PrtryData>
End proprietary message	</PrtryMsg>

6. 5.42 ReturnLegalEntity

SSP Proprietary Messages

ReturnLegalEntity_SD

Scope: This is the response to the XML request : GetLegalEntity

<camt.998.001.xx>

Structure:

Name Proprietary message	<PrtryMsg>
Message Header	<MsgHdr>
Message Identification	<MsgId></MsgId>
End of Message Header	</MsgHdr>
Related	<Rltd>
Reference	<Ref></Ref>
End of Related	</Rltd>
Proprietary Data	<PrtryData>
Proprietary Data type	<Tp>ReturnLegalEntity</Tp>
Proprietary Data	<Data>
SSP Proprietary Data	<SspPrtryDt>
Message Type	<ReturnLegalEntity>
Choice amongst	<xorBizRptOprlErr>
BusinessReport	<BizRpt>
Legal Entity	<LglNtty>
Record Status Information	<RecStsInf>
Planned Change	<PlndChng></PlndChng>
Record Status	<RecSts></RecSts>
First Activation Date	<FrstDt></FrstDt>
Modification Date	<ModDt></ModDt>
End Date	<EndDt></EndDt>
End of Record Status Information	</RecStsInf>
Legal Entity Information	<LglNttyInf>
CB Responsible	<Ctry></Ctry>
Legal Entity Name1	<LglNttyNm1></LglNttyNm1>
Legal Entity Name2	<LglNttyNm2></LglNttyNm2>
Legal Entity Name3	<LglNttyNm3></LglNttyNm3>
BIC Legal Entity	<BICLglNtty></BICLglNtty>
City	<Cty></Cty>
End of Legal Entity Information	</LglNttyInf>
End of Legal Entity	</LglNtty>
End of BusinessReport	</BizRpt>
OperationalError	<OprlErr>
Error handling	<Err>
Proprietary error code	<Prtry></Prtry>
End error handling	</Err>
Description	<Desc></Desc>
End of Operational Error	</OprlErr>
End of choice	</xorBizRptOprlErr>
End of Message Type	</ReturnLegalEntity>
End of SSP Proprietary Data	</SspPrtryDt>
End of Proprietary Data	</Data>
End of Proprietary Data	</PrtryData>
End proprietary message	</PrtryMsg>

Attributes:

name of attribute	format	short description	description
<PrtryMsg>		Name Proprietary message Mandatory	Validation: [1..1]
<MsgHdr>		Message Header Mandatory	Set of characteristics specific to the message Validation: [1..1]
<MsgId></MsgId>	35x	Message Identification Mandatory	Message Identification Validation: [1..1]
</MsgHdr>		End of Message Header Mandatory	Validation: [1..1]
<Rltd>		Related Optional	References a previously received message. Validation: [0..1]
<Ref></Ref>	35x	Reference Mandatory	Unique and unambiguous reference Validation: [1..1]
</Rltd>		End of Related Optional	End of Related Validation: [0..1]
<PrtryData>		Proprietary Data Mandatory	Proprietary Data Validation: [1..1]
<Tp></Tp>	35x	Proprietary Data type Mandatory	Proprietary Data type defines the Type of the free format XML Validation: [1..1]
<Data>		Proprietary Data Mandatory	Proprietary data content Validation: [1..1]
<SspPrtryDt>		SSP Proprietary Data Mandatory	Root element for all SSP proprietary data Validation: [1..1]
<ReturnLegalEntity>		Message Type Mandatory	Message Type for Static Data Validation: [1..1]
xorBizRptOpriErr		Choice amongst Optional	Choice amongst xorBizRptOpriErr (Type: xor) Validation:

name of attribute	format	short description	description
<BizRpt>		BusinessReport	<p>BusinessReport</p> <p>Rule rationale: The message will contain either the information matching the search criteria of the related Get message or an error indication.</p> <p>Rule description: If BusinessReport is present then OperationalError is not allowed. If BusinessReport is not present, then OperationalError is mandatory.</p> <p>Mandatory</p> <p>Validation: [1..1]</p>
<LglNtty>		Legal Entity	<p>Legal Entity</p> <p>Mandatory</p> <p>Validation: [1..n]</p>
<RecStsInf>		Record Status Information	<p>Record Status Information</p> <p>Mandatory</p> <p>Validation: [1..1]</p>
<PlnndChng>-</PlnndChng>	1!a	Planned Change	<p>Information on record regarding the presence of a future record. Values may be :</p> <p>"N" if no future record is present "D" if the record will be deleted "M" if a future record exists</p> <p>Note : the Planned Change flag has been added in order to help users when displaying an active record. Actually, for an active record with an End Date different from '9999-12-31', it is not possible to know whether the related record will be deleted (when the system reach the End Date) or if a future record exists and will be active, as a substitute for the active one.</p> <p>The use of the Planned Change flag is made to have information on the future of an active record.</p> <p>Mandatory</p> <p>Validation: [1..1]</p>
<RecSts>-</RecSts>	2x	Record Status	<p>Status of the record. List of values :</p> <p>"AC" for Active "FU" for Future "RE" for Rejected "AR" for Archived "AF" for Archived Future "IC" for In Change "DV" for Delivery (Technical) "ID" for In Deletion (Technical)</p> <p>For more information on status management, refer to the ICM UserHandBook.</p> <p>Mandatory</p> <p>Validation: [1..1]</p>
<FrstDt>-</FrstDt>	ISODate	First Activation Date	<p>Date within a particular calendar year represented by YYYY-MM-DD (ISO 8601). This date represents the first activation date of a functional item, such as a Participant. It is different from the modification date, which is the last date when a modification occurred.</p> <p>Mandatory</p> <p>Validation: [1..1]</p>

name of attribute	format	short description	description
<ModDt>-</ModDt>	ISODate	Modification Date	Date within a particular calendar year represented by YYYY-MM-DD (ISO 8601). This is the modification date of the related record. If the record has not been modified since its activation, the modification date is equal to the first activation date. Mandatory Validation: [1..1]
<EndDt>-</EndDt>	ISODate	End Date	Date within a particular calendar year represented by YYYY-MM-DD (ISO 8601). This is the end date of the related record. Value is equal to '9999-12-31' if no modification or deletion are foreseen for this record. Otherwise, the End Date takes the value of the modification date or date of the deletion. Optional Validation: [0..1]
</RecStsInf>		End of Record Status Information Mandatory	End of Record Status Information Validation: [1..1]
<LglNttyInf>		Legal Entity Information Mandatory	Legal Entity Information Validation: [1..1]
<Ctry>-</Ctry>	2!c	CB Responsible Mandatory	Country Code of the Responsible CB. Validation: [1..1]
<LglNttyNm1>-</LglNttyNm1>	35x	Legal Entity Name1 Mandatory	Legal Entity Name first line. Validation: [1..1]
<LglNttyNm2>-</LglNttyNm2>	35x	Legal Entity Name2 Optional	Legal Entity Name, second line. Validation: [0..1]
<LglNttyNm3>-</LglNttyNm3>	35x	Legal Entity Name3 Optional	Legal Entity Name, third line. Validation: [0..1]
<BICLglNtty>-</BICLglNtty>	11x	BIC Legal Entity Mandatory	A code allocated to a financial institution by a Registration Authority under an international identification scheme, as described in the latest edition of the international standard ISO 9362 "Banking - Banking telecommunication messages - Bank identifier codes". In this case, this is the BIC 11 of a Legal Entity. Validation: [1..1]
<Cty>-</Cty>	35x	City Mandatory	City of the Legal Entity (35x) Validation: [1..1]

name of attribute	format	short description	description
</LglNttyInf>		End of Legal Entity Information Mandatory	End of Legal Entity Information Validation: [1..1]
</LglNtty>		End of Legal Entity Mandatory	End of Legal Entity Validation: [1..n]
</BizRpt>		End of BusinessReport Mandatory	End of BusinessReport Validation: [1..1]
<OprlErr>		OperationalError Mandatory	Rule rationale: The message will contain either the information matching the search criteria of the related Get message or an error indication. Rule description: If BusinessReport is present then OperationalError is not allowed. If BusinessReport is not present, then OperationalError is mandatory. Separate Specification see UDFS books regarding error codes Validation: [1..1]
<Err>		Error handling Mandatory	Validation: [1..1]
<Prtry>-</Prtry>	4x	Proprietary error code Mandatory	Specification of the error, in free format. Validation: [1..1]
</Err>		End error handling Mandatory	Validation: [1..1]
<Desc>-</Desc>	140x	Description Optional	Specification of the error, in free format. Validation: [0..1]
</OprlErr>		End of Operational Error Mandatory	End of Operational Error Validation: [1..1]
/xorBizRptOprlErr		End of choice Optional	End of Choice Validation:
</ReturnLegalEntity>		End of Message Type Mandatory	End of Message Type for Static Data Validation: [1..1]
</SspPrtryDt>		End of SSP Proprietary Data Mandatory	End of Root element for all SSP proprietary data Validation: [1..1]

name of attribute	format	short description	description
</Data>		End of Proprietary Data	
		Mandatory	Validation: [1..1]
</PrtryData>		End of Proprietary Data	End of Proprietary Data
		Mandatory	Validation: [1..1]
</PrtryMsg>		End proprietary message	
		Mandatory	Validation:

Error Codes:

ReturnLegalEntity_SD_1

Scope: This is the response to the XML request : GetLegalEntity

Name Proprietary message	<PrtryMsg>
Message Header	<MsgHdr>
Message Identification	<MsgId>13589332451711382686015</MsgId>
End of Message Header	</MsgHdr>
Related	<Rltd>
Reference	<Ref>ABC123</Ref>
End of Related	</Rltd>
Proprietary Data	<PrtryData>
Proprietary Data type	<Tp>ReturnLegalEntity</Tp>
Proprietary Data	<Data>
SSP Proprietary Data	<SspPrtryDt>
Message Type	<ReturnLegalEntity>
BusinessReport	<BizRpt>
Legal Entity	<LglNtty>
Record Status Information	<RecStsInf>
Planned Change	<PlndChng>N</PlndChng>
Record Status	<RecSts>AC</RecSts>
First Activation Date	<FrstDt>2008-06-12</FrstDt>
Modification Date	<ModDt>2012-04-24</ModDt>
End Date	<EndDt>9999-12-31</EndDt>
End of Record Status Information	</RecStsInf>
Legal Entity Information	<LglNttyInf>
CB Responsible	<Ctry>FR</Ctry>
Legal Entity Name1	<LglNttyNm1>ZYAJFRT0FAC</LglNttyNm1>
BIC Legal Entity	<BICLglNtty>ZYAJFRT0FAC</BICLglNtty>
City	<Cty>City</Cty>
End of Legal Entity Information	</LglNttyInf>
End of Legal Entity	</LglNtty>
End of BusinessReport	</BizRpt>
End of Message Type	</ReturnLegalEntity>
End of SSP Proprietary Data	</SspPrtryDt>
End of Proprietary Data	</Data>
End of Proprietary Data	</PrtryData>
End proprietary message	</PrtryMsg>

ReturnLegalEntity_SD_2

Scope: This is the error response to the XML request : GetLegalEntity

Name Proprietary message	<PrtryMsg>
Message Header	<MsgHdr>
Message Identification	<MsgId>13589332451711382686016</MsgId>
End of Message Header	</MsgHdr>
Related	<Rltd>
Reference	<Ref>BABC123</Ref>
End of Related	</Rltd>
Proprietary Data	<PrtryData>
Proprietary Data type	<Tp>ReturnLegalEntity</Tp>
Proprietary Data	<Data>
SSP Proprietary Data	<SspPrtryDt>
Message Type	<ReturnLegalEntity>
OperationalError	<OprlErr>
Error handling	<Err>
Proprietary error code	<Prtry>S100</Prtry>
End error handling	</Err>
Description	<Desc>No data available for selected criteria - Result was empty!</Desc>
End of Operational Error	</OprlErr>
End of Message Type	</ReturnLegalEntity>
End of SSP Proprietary Data	</SspPrtryDt>
End of Proprietary Data	</Data>
End of Proprietary Data	</PrtryData>
End proprietary message	</PrtryMsg>

6. 5.43 ReturnParticipant

SSP Proprietary Messages

ReturnParticipant_SD

Scope: This is the response to the XML Request : GetParticipant

<camt.998.001.xx>

Structure:

Name Proprietary message	<PrtryMsg>
Message Header	<MsgHdr>
Message Identification	<MsgId></MsgId>
End of Message Header	</MsgHdr>
Related	<Rltd>
Reference	<Ref></Ref>
End of Related	</Rltd>
Proprietary Data	<PrtryData>
Proprietary Data type	<Tp>ReturnParticipant</Tp>
Proprietary Data	<Data>
SSP Proprietary Data	<SspPrtryDt>
Message Type	<ReturnParticipant>
Choice amongst	<xorBizRptOprlErr>
BusinessReport	<BizRpt>
Participant	<Ptcpt>
Record Status Information	<RecStsInf>
Planned Change	<PlndChng></PlndChng>
Record Status	<RecSts></RecSts>
First Activation Date	<FrstDt></FrstDt>
Modification Date	<ModDt></ModDt>
End Date	<EndDt></EndDt>
End of Record Status Information	</RecStsInf>
Participant Information	<PtcptInf>
Exclusion	<PtcptXclsn></PtcptXclsn>
CB Responsible	<Ctry></Ctry>
Legal Entity Name1	<LglNttyNm1></LglNttyNm1>
Participant Type	<PtcptTp></PtcptTp>
BIC	<BIC></BIC>
BIC Addressee	<BICAddss></BICAddss>
BIC Account Holder	<BICAcctHldr></BICAcctHldr>
Main BIC Flag	<MainBICFlag></MainBICFlag>
National Sorting Code	<NSC></NSC>
MFI code	<MFICd></MFICd>
Participant Name1	<PtcptNm1></PtcptNm1>
Participant Name2	<PtcptNm2></PtcptNm2>
Participant Name3	<PtcptNm3></PtcptNm3>
Address of the participant	<PtcptAdr></PtcptAdr>
ZIP Code	<PtcptZIPCd></PtcptZIPCd>
City heading	<Cty></Cty>
Institutional Sector Code	<ISC></ISC>
Published in the T2 Dir	<Trgt2Pblshd></Trgt2Pblshd>
Internet-Based Participant Flag	<LVPFflag></LVPFflag>
Packed File Delivery	<PckdFile></PckdFile>
Service for FileAct in Push Mode	<Svc></Svc>

DN for Push Mode	<DN></DN>
End of Participant Information	</PtcptInf>
Account Information	<AcctInf>
RTGS Account	<RTGSAcct>
RTGS Participation	<RTGSTp></RTGSTp>
RTGS Account Number	<RTGSAcctNb></RTGSAcctNb>
Has Sub Account	<HasSubAcct></HasSubAcct>
End of RTGS Account	</RTGSAcct>
Pooling of liquidity	<PoolgLqdt>
Virtual Account	<VrtlAcct>
Group of Account Name	<GOANm></GOANm>
Group of Accounts ID	<GOAId></GOAId>
Main Account of GoA	<MainAcct></MainAcct>
End of Virtual Account	</VrtlAcct>
Consolidated Information	<CnsldtdInf>
Group of Account Name	<GOANm></GOANm>
Group of Accounts ID	<GOAId></GOAId>
Main Account of GoA	<MainAcct></MainAcct>
End of Consolidated Information	</CnsldtdInf>
Banking Group Monitoring	<BGM>
Group of Account Name	<GOANm></GOANm>
Group of Accounts ID	<GOAId></GOAId>
Main Account of GoA	<MainAcct></MainAcct>
End of Banking Group Monitoring	</BGM>
End of Pooling of liquidity	</PoolgLqdt>
HAM Account	<HamAccount>
Co-managed accounts	<CmngdAcct></CmngdAcct>
MT900 Notification for Co-Manager	<Ntfctn900Cmng></Ntfctn900Cmng>
MT910 Notification for Co-Manager	<Ntfctn910Cmng></Ntfctn910Cmng>
Balance Report for Co-Manager	<BalRptCmng></BalRptCmng>
HAM Account Number	<HamAcctNb></HamAcctNb>
End of HAM Account	</HamAccount>
End of Account Information	</AcctInf>
Compulsory Reserve Information	<CRinf>
Minimum Reserve Management	<CRMgmt></CRMgmt>
Source of Compulsory Reserve	<CRSrc></CRSrc>
BIC of Direct Maintainer	<BICMntnr></BICMntnr>
BIC of MFI Leader	<BICMFILdr></BICMFILdr>
End of Compulsory Reserve Information	</CRinf>
SF Allow	<StgFclts></StgFclts>
T2S VA Allow	<T2SVASvc></T2SVASvc>
End of Participant	</Ptcpt>
End of BusinessReport	</BizRpt>
OperationalError	<OprlErr>
Error handling	<Err>
Proprietary error code	<Prtry></Prtry>
End error handling	</Err>
Description	<Desc></Desc>
End of Operational Error	</OprlErr>
End of choice	</xorBizRptOprlErr>
End of Message Type	</ReturnParticipant>
End of SSP Proprietary Data	</SspPrtryDt>

End of Proprietary Data
End of Proprietary Data
End proprietary message

```
| | </Data>  
| | </PrtryData>  
| </PrtryMsg>
```

Attributes:

name of attribute	format	short description	description
<PrtryMsg>		Name Proprietary message Mandatory	Validation: [1..1]
<MsgHdr>		Message Header Mandatory	Set of characteristics specific to the message Validation: [1..1]
<MsgId></MsgId>	35x	Message Identification Mandatory	Message Identification Validation: [1..1]
</MsgHdr>		End of Message Header Mandatory	Validation: [1..1]
<Rltd>		Related Optional	References a previously received message. Validation: [0..1]
<Ref></Ref>	35x	Reference Mandatory	Unique and unambiguous reference Validation: [1..1]
</Rltd>		End of Related Optional	End of Related Validation: [0..1]
<PrtryData>		Proprietary Data Mandatory	Proprietary Data Validation: [1..1]
<Tp></Tp>	35x	Proprietary Data type Mandatory	Proprietary Data type defines the Type of the free format XML Validation: [1..1]
<Data>		Proprietary Data Mandatory	Proprietary data content Validation: [1..1]
<SspPrtryDt>		SSP Proprietary Data Mandatory	Root element for all SSP proprietary data Validation: [1..1]
<ReturnParticipant>		Message Type Mandatory	Message Type for Static Data Validation: [1..1]
xorBizRptOpriErr		Choice amongst	Choice amongst xorBizRptOpriErr (Type: xor)

name of attribute	format	short description	description
		Optional	Validation:
<BizRpt>		BusinessReport	BusinessReport Rule rationale: The message will contain either the information matching the search criteria of the related Get message or an error indication. Rule description: If BusinessReport is present then OperationalError is not allowed. If BusinessReport is not present, then OperationalError is mandatory.
		Mandatory	Validation: [1..1]
<Ptcpt>		Participant	Participant
		Mandatory	Validation: [1..n]
<RecStsInf>		Record Status Information	Record Status Information
		Mandatory	Validation: [1..1]
<PlnndChng>-</PlnndChng>	1!a	Planned Change	Information on record regarding the presence of a future record. Values may be : "N" if no future record is present "D" if the record will be deleted "M" if a future record exists Note : the Planned Change flag has been added in order to help users when displaying an active record. Actually, for an active record with an End Date different from '9999-12-31', it is not possible to know whether the related record will be deleted (when the system reach the End Date) or if a future record exists and will be active, as a substitute for the active one. The use of the Planned Change flag is made to have information on the future of an active record.
		Mandatory	Validation: [1..1]
<RecSts>-</RecSts>	2x	Record Status	Status of the record. List of values : "AC" for Active "FU" for Future "RE" for Rejected "AR" for Archived "AF" for Archived Future "IC" for In Change "DV" for Delivery (Technical) "ID" for In Deletion (Technical) For more information on status management, refer to the ICM UserHandBook.
		Mandatory	Validation: [1..1]
<FrstDt>-</FrstDt>	ISODate	First Activation Date	Date within a particular calendar year represented by YYYY-MM-DD (ISO 8601). This date represents the first activation date of a functional item, such as a Participant. It is different from the modification date, which is the last date when a modification occurred.
		Mandatory	Validation:

name of attribute	format	short description	description
			[1..1]
<ModDt>-</ModDt>	ISODate	Modification Date	Date within a particular calendar year represented by YYYY-MM-DD (ISO 8601). This is the modification date of the related record. If the record has not been modified since its activation, the modification date is equal to the first activation date. Mandatory Validation: [1..1]
<EndDt>-</EndDt>	ISODate	End Date	Date within a particular calendar year represented by YYYY-MM-DD (ISO 8601). This is the end date of the related record. Value is equal to '9999-12-31' if no modification or deletion are foreseen for this record. Otherwise, the End Date takes the value of the modification date or date of the deletion. Optional Validation: [0..1]
</RecStsInf>		End of Record Status Information Mandatory	End of Record Status Information Validation: [1..1]
<PtcptInf>		Participant Information Mandatory	Participant Information Validation: [1..1]
<PtcptXclsn>-</PtcptXclsn>	1!a	Exclusion Mandatory	Exclusion for Participant : A flag with two values : 'Y' or 'N' Validation: [1..1]
<Ctry>-</Ctry>	2!c	CB Responsible Mandatory	Country Code of the Responsible CB. Validation: [1..1]
<LglNttyNm1>-</LglNttyNm1>	35x	Legal Entity Name1 Mandatory	Legal Entity Name first line. Validation: [1..1]
<PtcptTp>-</PtcptTp>	2!c	Participant Type Mandatory	Type of participation. Values may be : CB" for Central Bank "CI" for Credit Institution "CU" for CB's Customer "TC" for Technical "AL" for getting all type of Participant (used for 'Get' XML Message). Validation: [1..1]
<BIC>-</BIC>	4!a2!a2!c3!c	BIC	A code allocated to a financial institution by a Registration Authority under an international identification scheme, as described in the latest edition of the international standard ISO 9362 "Banking - Banking telecommunication messages - Bank identifier codes". For this case, this is the BIC 11 of the participant

name of attribute	format	short description	description
		Mandatory	Validation: [1..1]
<BICAddss>-</BICAddss>	4!a2!a2!c[3!c]	BIC Addressee	A code allocated to a financial institution by a Registration Authority under an international identification scheme, as described in the latest edition of the international standard ISO 9362 "Banking - Banking telecommunication messages - Bank identifier codes". In this case, this is the Addressee BIC (BIC 11).
		Optional	Validation: [0..1]
<BICAcctHldr>-</BICAcctHldr>	4!a2!a2!c[3!c]	BIC Account Holder	A code allocated to a financial institution by a Registration Authority under an international identification scheme, as described in the latest edition of the international standard ISO 9362 "Banking - Banking telecommunication messages - Bank identifier codes". In this case, this is the BIC 11 of the Account Holder.
		Optional	Validation: [0..1]
<MainBICFlag>-</MainBICFlag>	1!a	Main BIC Flag	A flag with two values : 'Y' or 'N'. This flag indicates that the related BIC is the main BIC to be used when a user has no information where to send to.
		Mandatory	Validation: [1..1]
<NSC>-</NSC>	15n	National Sorting Code	Code present in the BIC DATA +. Character string with a max length of 15 characters.
		Optional	Validation: [0..1]
<MFICd>-</MFICd>	30x	MFI code	MFI code of institutions
		Optional	Validation: [0..1]
<PtcptNm1>-</PtcptNm1>	35x	Participant Name1	Participant Name, first line.
		Mandatory	Validation: [1..1]
<PtcptNm2>-</PtcptNm2>	35x	Participant Name2	Participant Name, second line.
		Optional	Validation: [0..1]
<PtcptNm3>-</PtcptNm3>	35x	Participant Name3	Participant name, third line.
		Optional	Validation: [0..1]
<PtcptAdr>-</PtcptAdr>	140x	Address of the participant	Address of the participant
		Optional	Validation: [0..1]
<PtcptZIPCd>-</PtcptZIPCd>	15x	ZIP Code	ZIP Code
		Optional	Validation:

name of attribute	format	short description	description
			[0..1]
<Cty>-</Cty>	35x	City heading Mandatory	City (35x) Validation: [1..1]
<ISC>-</ISC>	35x	Institutional Sector Code Mandatory	Institutional Sector Code Validation: [1..1]
<Trgt2Pblshd>-</Trgt2Pblshd>	1!a	Published in the T2 Dir Mandatory	A flag with two values : 'Y' or 'N'. Used to publish or not the related Participant in the Target 2 Directory. Validation: [1..1]
<LVPFlag>-</LVPFlag>	1!a	Internet-Based Participant Flag Mandatory	A flag with two values : 'Y' or 'N'. Flag to identify an internet-based participant. Validation: [1..1]
<PckdFile>-</PckdFile>	1!a	Packed File Delivery Mandatory	A flag with two values : 'Y' or 'N' This flag indicates whether the participant wants to receive all SWIFTNet messages sent by the SSP in packed mode. Validation: [1..1]
<Svc>-</Svc>	30x	Service for FileAct in Push Mode Optional	Service (for push mode functionalities) Validation: [0..1]
<DN>-</DN>	100x	DN for Push Mode Optional	Distinguished Name, made of max 100 characters (for push mode functionalities). Validation: [0..1]
</PtcptInf>		End of Participant Information Optional	End of Participant Information Validation: [0..1]
<AcctInf>		Account Information Optional	Account Information Validation: [0..1]
<RTGSAcct>		RTGS Account Optional	RTGS Account Validation: [0..1]
<RTGSTp>-</RTGSTp>	1!a	RTGS Participation Mandatory	Defines the type of participation in the RTGS. List of values : "D" for Direct Participant "I" for Indirect Participant "N" for No Participation "A" for getting all type of RTGS Participation (used for 'Get' XML Message). Validation:

name of attribute	format	short description	description
			[1..1]
<RTGSAcctNb>-</RTGSAcctNb>	2!c32x	RTGS Account Number	Account Number. Length 34 characters. First two characters represent the country code of the responsible CB.
		Mandatory	Validation: [1..1]
<HasSubAcct>-</HasSubAcct>	1!a	Has Sub Account	A flag with two values : 'Y' or 'N'. This flag indicates whether a participant has (value 'Y') or not (value 'N') sub account(s).
		Mandatory	Validation: [1..1]
</RTGSAcct>		End of RTGS Account	End of RTGS Account
		Optional	Validation: [0..1]
<PoolgLqdy>		Pooling of liquidity	Pooling of liquidity (Group of Accounts)
		Optional	Validation: [0..1]
<VrtlAcct>		Virtual Account	Virtual Account
		Optional	Validation: [0..1]
<GOANm>-</GOANm>	35x	Group of Account Name	Group of Account Name
		Optional	Validation: [0..1]
<GOAId>-</GOAId>	12x	Group of Accounts ID	Group of Accounts ID. Length 12 characters.
		Optional	Validation: [0..1]
<MainAcct>-</MainAcct>	4!a2!a2!c[3!c]	Main Account of GoA	A code allocated to a financial institution by a Registration Authority under an international identification scheme, as described in the latest edition of the international standard ISO 9362 "Banking - Banking telecommunication messages - Bank identifier codes".
		Optional	In this case, this is the BIC 11 identifying the main account of a Group of Accounts. Validation: [0..1]
</VrtlAcct>		End of Virtual Account	End of Virtual Account
		Optional	Validation: [0..1]
<CnsltdInf>		Consolidated Information	Consolidated Information Group of Account
		Optional	Validation: [0..1]
<GOANm>-</GOANm>	35x	Group of Account Name	Group of Account Name
		Optional	Validation: [0..1]

name of attribute	format	short description	description
<GOAId>-</GOAId>	12x	Group of Accounts ID	Group of Accounts ID. Lenght 12 characters.
		Optional	Validation: [0..1]
<MainAcct>-</MainAcct>	4!a2!a2!c[3! c]	Main Account of GoA	A code allocated to a financial institution by a Registration Authority under an international identification scheme, as described in the latest edition of the international standard ISO 9362 "Banking - Banking telecommunication messages - Bank identifier codes".
		Optional	In this case, this is the BIC 11 identifying the main account of a Group of Accounts. Validation: [0..1]
</CnsldtdInf>		End of Consolidated Information	End of Consolidated Information
		Optional	Validation: [0..1]
<BGM>		Banking Group Monitoring	Banking Group Monitoring
		Optional	Validation: [0..1]
<GOANm>-</GOANm>	35x	Group of Account Name	Group of Account Name
		Optional	Validation: [0..1]
<GOAId>-</GOAId>	12x	Group of Accounts ID	Group of Accounts ID. Lenght 12 characters.
		Optional	Validation: [0..1]
<MainAcct>-</MainAcct>	4!a2!a2!c[3! c]	Main Account of GoA	A code allocated to a financial institution by a Registration Authority under an international identification scheme, as described in the latest edition of the international standard ISO 9362 "Banking - Banking telecommunication messages - Bank identifier codes".
		Optional	In this case, this is the BIC 11 identifying the main account of a Group of Accounts. Validation: [0..1]
</BGM>		End of Banking Group Monitoring	End of Banking Group Monitoring
		Optional	Validation: [0..1]
</PoolgLqdy>		End of Pooling of liquidity	End of Pooling of liquidity
		Optional	Validation: [0..1]
<HamAccount>		HAM Account	HAM Account
		Optional	Validation: [0..1]
<CmngdAcct>-</CmngdAcct>	1!a	Co-managed accounts	A flag with two values : 'Y' or 'N'. This flag indicates whether the participant is (value 'Y') or not (value 'N') co-manager of HAM Accounts.

name of attribute	format	short description	description
		Optional	Validation: [0..1]
<Ntfctn900Cmngr>- </Ntfctn900Cmngr>	1!a	MT900 Notification for Co-Manager	A flag with two values : 'Y' or 'N'. This flag indicates that the co-manager has chosen to receive MT900 for each debit in co-managed HAM Accounts.
		Mandatory	Validation: [1..1]
<Ntfctn910Cmngr>- </Ntfctn910Cmngr>	1!a	MT910 Notification for Co-Manager	A flag with two values : 'Y' or 'N'. This flag indicates that the co-manager has chosen to receive MT910 for each credit in co-managed HAM Accounts.
		Mandatory	Validation: [1..1]
<BalRptCmngr>- </BalRptCmngr>	3!n	Balance Report for Co-Manager	This is the Swift message type for Balance Report. List of values : "940" or "950"
		Optional	Validation: [0..1]
<HamAcctNb>-</HamAcctNb>	2!c32x	HAM Account Number	Account Number. Lenght 34 characters. The first two characters represent the country code of the responsible CB. The Account Number is unique within the HAM.
		Optional	Validation: [0..1]
</HamAccount>		End of HAM Account	End of HAM Account
		Optional	Validation: [0..1]
</AcctInf>		End of Account Information	End of Account Information
		Optional	Validation: [0..1]
<CRInf>		Compulsory Reserve Information	Compulsory Reserve Information
		Optional	Validation: [0..1]
<CRMgmt>-</CRMgmt>	1!a	Minimum Reserve Management	This information represents the way a participant is managing minimum reserve. Values are : "D" for Direct (the participant is managing minimum reserve by itself) "I" for Indirect (the participant is managing minimum reserve through another participant) "P" for Pool (the participant is part of a MFI in order to manage minimum reserve) "L" for Locally "N" for No if the participant is not managing minimum reserve "A" for getting all values (used in the 'Get' XML Message).
		Mandatory	Validation: [1..1]
<CRSrc>-</CRSrc>	1!a	Source of Compulsory Reserve	Gives the source of compulsory reserve. Values are : "R" for RTGS Account "H" for HAM Account "P" for PHA (Proprietary Home Account)

name of attribute	format	short description	description
		Optional	"A" for getting all values (used in the 'Get' XML Message). Validation: [0..1]
<BICMntnr>-</BICMntnr>	4!a2!a2!c[3!c]	BIC of Direct Maintainer	A code allocated to a financial institution by a Registration Authority under an international identification scheme, as described in the latest edition of the international standard ISO 9362 "Banking - Banking telecommunication messages - Bank identifier codes". In this case, this is the BIC 11 of the direct maintainer for minimum reserve management. Validation: [0..1]
<BICMFILdr>-</BICMFILdr>	4!a2!a2!c[3!c]	BIC of MFI Leader	A code allocated to a financial institution by a Registration Authority under an international identification scheme, as described in the latest edition of the international standard ISO 9362 "Banking - Banking telecommunication messages - Bank identifier codes". In this case, this is the BIC 11 of the MFI leader for minimum reserve management. Validation: [0..1]
</CRinf>		End of Compulsory Reserve Information Optional	End of Compulsory Reserve Information Validation: [0..1]
<StgFclts>-</StgFclts>	1!a	SF Allow Mandatory	A flag with two values : 'Y' or 'N'. Indicates the possibility to use Standing facilities. Validation: [1..1]
<T2SVASvc>-</T2SVASvc>	1!a	T2S VA Allow Optional	A flag with two values : 'Y' or 'N' indicates the participant has opted for T2S value-added service package Validation: [0..1]
</Ptcpt>		End of Participant Optional	End of Participant Validation: [0..1]
</BizRpt>		End of BusinessReport Optional	End of BusinessReport Validation: [0..1]
<OprlErr>		OperationalError Mandatory	Rule rationale: The message will contain either the information matching the search criteria of the related Get message or an error indication. Rule description: If BusinessReport is present then OperationalError is not allowed. If BusinessReport is not present, then OperationalError is mandatory. Separate Specification see UDFS books regarding error codes Validation:

name of attribute	format	short description	description
			[1..1]
<Err>		Error handling Mandatory	Validation: [1..1]
<Prtry>-</Prtry>	4x	Proprietary error code Mandatory	Specification of the error, in free format. Validation: [1..1]
</Err>		End error handling Mandatory	Validation: [1..1]
<Desc>-</Desc>	140x	Description Optional	Specification of the error, in free format. Validation: [0..1]
</OprlErr>		End of Operational Error Mandatory	End of Operational Error Validation: [1..1]
/xorBizRptOprlErr		End of choice Optional	End of Choice Validation:
</ReturnParticipant>		End of Message Type Mandatory	End of Message Type for Static Data Validation: [1..1]
</SspPrtryDt>		End of SSP Proprietary Data Mandatory	End of Root element for all SSP proprietary data Validation: [1..1]
</Data>		End of Proprietary Data Mandatory	Validation: [1..1]
</PrtryData>		End of Proprietary Data Mandatory	End of Proprietary Data Validation: [1..1]
</PrtryMsg>		End proprietary message Mandatory	Validation:

Error Codes:

ReturnParticipant_SD_1

Scope: Response to the XML GetParticipant Request for the Participant ZYBLDEF0LD4

Name Proprietary message	<PrtryMsg>
Message Header	<MsgHdr>
Message Identification	<MsgId>1358848752965363271226</MsgId>
End of Message Header	</MsgHdr>
Related	<Rltd>
Reference	<Ref>GetPartZYBLDEF0LD4</Ref>
End of Related	</Rltd>
Proprietary Data	<PrtryData>
Proprietary Data type	<Tp>ReturnParticipant</Tp>
Proprietary Data	<Data>
SSP Proprietary Data	<SspPrtryDt>
Message Type	<ReturnParticipant>
BusinessReport	<BizRpt>
Participant	<Ptcpt>
Record Status Information	<RecStsInf>
Planned Change	<PlnndChng>N</PlnndChng>
Record Status	<RecSts>AC</RecSts>
First Activation Date	<FrstDt>2008-06-12</FrstDt>
Modification Date	<ModDt>2011-01-19</ModDt>
End Date	<EndDt>9999-12-31</EndDt>
End of Record Status Information	</RecStsInf>
Participant Information	<PtcptInf>
Exclusion	<PtcptXclsn>N</PtcptXclsn>
CB Responsible	<Ctry>LU</Ctry>
Legal Entity Name1	<LglNttyNm1>FDE-LE-LU-ZYBLDEF0LD4</LglNttyNm1>
Participant Type	<PtcptTp>CI</PtcptTp>
BIC	<BIC>ZYBLDEF0LD4</BIC>
BIC Addressee	<BICAddss>ZYBLDEF0LD4</BICAddss>
BIC Account Holder	<BICAcctHldr>ZYBLDEF0LD4</BICAcctHldr>
Main BIC Flag	<MainBICFlag>N</MainBICFlag>
Participant Name1	<PtcptNm1>FDE-CI-LU-ZYBLDEF0LD4</PtcptNm1>
Address of the participant	<PtcptAdr>ZYBLDEF0LD4</PtcptAdr>
City heading	<Cty>City</Cty>
Institutional Sector Code	<ISC>S12</ISC>
Published in the T2 Dir	<Trgt2Pblshd>Y</Trgt2Pblshd>
Internet-Based Participant Flag	<LVPFlag>N</LVPFlag>
Packed File Delivery	<PckdFile>Y</PckdFile>
End of Participant Information	</PtcptInf>
Account Information	<AcctInf>
RTGS Account	<RTGSAcct>
RTGS Participation	<RTGSTp>D</RTGSTp>
RTGS Account Number	<RTGSAcctNb>LUPCINZYBLDEF0LD400000000000003009</RTGSAcctNb>
Has Sub Account	<HasSubAcct>Y</HasSubAcct>
End of RTGS Account	</RTGSAcct>
Pooling of liquidity	<PoolgLqdy>
Virtual Account	<VrtlAcct>
Group of Account Name	<GOANm>FDE-GOA18-LU-VA</GOANm>
Group of Accounts ID	<GOAId>GOA18</GOAId>

Main Account of GoA		<MainAcct>ZYBLDEF0LD3</MainAcct>
End of Virtual Account		</VrtlAcct>
Consolidated Information		<CnsltdtdInf>
Group of Account Name		<GOANm>FDE-GOA04-DE-CoInfo</GOANm>
Group of Accounts ID		<GOAId>GOA04</GOAId>
Main Account of GoA		<MainAcct>ZYBRDEF0RP1</MainAcct>
End of Consolidated Information		</CnsltdtdInf>
End of Pooling of liquidity		</PoolgLqdy>
HAM Account		<HamAccount>
Co-managed accounts		<CmngdAcct>Y</CmngdAcct>
MT900 Notification for Co-Manager		<Ntfctn900Cmng>N</Ntfctn900Cmng>
MT910 Notification for Co-Manager		<Ntfctn910Cmng>N</Ntfctn910Cmng>
HAM Account Number		<HamAcctNb>LUHSUXZYBLDEF0LD400000000000 013009</HamAcctNb>
End of HAM Account		</HamAccount>
End of Account Information		</AcctInf>
Compulsory Reserve Information		<CRInf>
Minimum Reserve Management		<CRMgmt>D</CRMgmt>
Source of Compulsory Reserve		<CRSrc>H</CRSrc>
End of Compulsory Reserve Information		</CRInf>
SF Allow		<StgFclts>Y</StgFclts>
End of Participant		</Ptcpt>
End of BusinessReport		</BizRpt>
End of Message Type		</ReturnParticipant>
End of SSP Proprietary Data		</SspPrtryDt>
End of Proprietary Data		</Data>
End of Proprietary Data		</PrtryData>
End proprietary message		</PrtryMsg>

ReturnParticipant_SD_2

Scope: Response to the XML GetParticipant Request for the Participant ZYAJFRT0HS1

Name Proprietary message	<PrtryMsg>
Message Header	<MsgHdr>
Message Identification	<MsgId>13588583396401250766353</MsgId>
End of Message Header	</MsgHdr>
Related	<Rltd>
Reference	<Ref>GetPartZYAJFRT0HS1</Ref>
End of Related	</Rltd>
Proprietary Data	<PrtryData>
Proprietary Data type	<Tp>ReturnParticipant</Tp>
Proprietary Data	<Data>
SSP Proprietary Data	<SspPrtryDt>
Message Type	<ReturnParticipant>
BusinessReport	<BizRpt>
Participant	<Ptcpt>
Record Status Information	<RecStsInf>
Planned Change	<PlnndChng>N</PlnndChng>
Record Status	<RecSts>AC</RecSts>
First Activation Date	<FrstDt>2008-06-12</FrstDt>
Modification Date	<ModDt>2012-03-08</ModDt>
End Date	<EndDt>9999-12-31</EndDt>
End of Record Status Information	</RecStsInf>
Participant Information	<PtcptInf>
Exclusion	<PtcptXclsn>N</PtcptXclsn>
CB Responsible	<Ctry>ES</Ctry>
Legal Entity Name1	<LglNttyNm1>SPAIN ASI SETTLEMENT BANKS</LglNttyNm1>
Participant Type	<PtcptTp>CI</PtcptTp>
BIC	<BIC>ZYAJFRT0HS1</BIC>
BIC Addressee	<BICAddss>ZYAJFRT0HS1</BICAddss>
BIC Account Holder	<BICAcctHldr>ZYAJFRT0HS1</BICAcctHldr>
Main BIC Flag	<MainBICFlag>N</MainBICFlag>
MFI code	<MFICd>Test MFI HS1</MFICd>
Participant Name1	<PtcptNm1>ASI Settlement Bank ZYAJFRT0HS1</PtcptNm1>
Address of the participant	<PtcptAdr>ZYAJFRT0HS1</PtcptAdr>
City heading	<Cty>City</Cty>
Institutional Sector Code	<ISC>S122</ISC>
Published in the T2 Dir	<Trgt2Pblshd>Y</Trgt2Pblshd>
Internet-Based Participant Flag	<LVPFlag>N</LVPFlag>
Packed File Delivery	<PckdFile>N</PckdFile>
End of Participant Information	</PtcptInf>
Account Information	<AcctInf>
RTGS Account	<RTGSAcct>
RTGS Participation	<RTGSTp>D</RTGSTp>
RTGS Account Number	<RTGSAcctNb>ESPCINZYAJFRT0HS10000000000001000</RTGSAcctNb>
Has Sub Account	<HasSubAcct>Y</HasSubAcct>
End of RTGS Account	</RTGSAcct>
HAM Account	<HamAccount>
Co-managed accounts	<CmngdAcct>N</CmngdAcct>
MT900 Notification for Co-Manager	<Nfctn900Cmng>N</Nfctn900Cmng>

MT910 Notification for Co-Manager								<Ntfctn910Cmng>N</Ntfctn910Cmng>
HAM Account Number								<HamAcctNb>ESZYAJFRT0HS1</HamAcctNb>
End of HAM Account								</HamAccount>
End of Account Information								</AcctInf>
Compulsory Reserve Information								<CRinf>
Minimum Reserve Management								<CRMgmt>N</CRMgmt>
End of Compulsory Reserve Information								</CRinf>
SF Allow								<StgFclts>Y</StgFclts>
End of Participant								</Ptcpt>
End of BusinessReport								</BizRpt>
End of Message Type								</ReturnParticipant>
End of SSP Proprietary Data								</SspPrtryDt>
End of Proprietary Data								</Data>
End of Proprietary Data								</PrtryData>
End proprietary message								</PrtryMsg>

ReturnParticipant_SD_3

Scope: Error message Response to the XML GetParticipant Request for an incorrect tag MsgTest

Name Proprietary message	<PrtryMsg>
Message Header	<MsgHdr>
Message Identification	<MsgId>8a8c818a3c5e982a013c61c65ffd0007</MsgId>
End of Message Header	</MsgHdr>
Related	<Rltd>
Reference	<Ref>1358850056189</Ref>
End of Related	</Rltd>
Proprietary Data	<PrtryData>
Proprietary Data type	<Tp>ReturnParticipant</Tp>
Proprietary Data	<Data>
SSP Proprietary Data	<SspPrtryDt>
Message Type	<ReturnParticipant>
OperationalError	<OprlErr>
Error handling	<Err>
Proprietary error code	<Prtry>1199</Prtry>
End error handling	</Err>
Description	<Desc>Error validating payload document: line: 3 column: 12 reason: tag name not allowed.</Desc>
End of Operational Error	</OprlErr>
End of Message Type	</ReturnParticipant>
End of SSP Proprietary Data	</SspPrtryDt>
End of Proprietary Data	</Data>
End of Proprietary Data	</PrtryData>
End proprietary message	</PrtryMsg>

6. 5.44 ReturnRTGSAccount

SSP Proprietary Messages

ReturnRTGSAccount_SD

Scope: This is the response to the XML request : GetRTGSAccount

<camt.998.001.xx>

Structure:

Name Proprietary message	<PrtryMsg>
Message Header	<MsgHdr>
Message Identification	<MsgId></MsgId>
End of Message Header	</MsgHdr>
Related	<Rltd>
Reference	<Ref></Ref>
End of Related	</Rltd>
Proprietary Data	<PrtryData>
Proprietary Data type	<Tp>ReturnRTGSAccount</Tp>
Proprietary Data	<Data>
SSP Proprietary Data	<SspPrtryDt>
Message Type	<ReturnRTGSAccount>
Choice amongst	<xorBizRptOprlErr>
BusinessReport	<BizRpt>
RTGS Account	<RTGSAcct>
Participant Information	<PtcptInf>
Participant Name1	<PtcptNm1></PtcptNm1>
BIC	<BIC></BIC>
BIC Addressee	<BICAddss></BICAddss>
National Sorting Code	<NSC></NSC>
End of Participant Information	</PtcptInf>
Record Status Information	<RecStsInf>
Planned Change	<PlnndChng></PlnndChng>
Record Status	<RecSts></RecSts>
First Activation Date	<FrstDt></FrstDt>
Modification Date	<ModDt></ModDt>
End Date	<EndDt></EndDt>
End of Record Status Information	</RecStsInf>
Account Information	<AcctInf>
RTGS Account Number	<RTGSAcctNb></RTGSAcctNb>
RTGS Account Type	<RTGSAcctTp></RTGSAcctTp>
Accept MT900/910	<AccptAdv></AccptAdv>
Balance Report	<BalRpt></BalRpt>
Maximum Amount per day	<MaxAmtDay></MaxAmtDay>
Credit Based Only	<CdtsBsd></CdtsBsd>
Contingency Account Number	<CtgncyAcctNb></CtgncyAcctNb>
End of Account Information	</AcctInf>
Liquidity Management	<LqdyMgmt>
During the Day	<DayLght>
Receiver BIC for Liq Removal Daylight	<BICLqdyRmvlDayLght></BICLqdyRmvlDayLght>
Account for Liq Removal Daylight	<AcctLqdyRmvlDayLght></AcctLqdyRmvlDayLght>
End of During the Day	</DayLght>
End of Day	<EoD>
Receiver BIC for Liq Removal EoD	<BICLqdyRmvlEoD></BICLqdyRmvlEoD>

Account for Liq Removal EoD	<AcctLqdyRmvIEoD></AcctLqdyRmvIEoD>
End of End of Day	</EoD>
End of Liquidity Management	</LqdyMgmt>
Pooling of liquidity	<PoolgLqdy>
Virtual Account	<VrtlAcct>
Group of Account Name	<GOANm></GOANm>
Group of Accounts ID	<GOAId></GOAId>
Main Account of GoA	<MainAcct></MainAcct>
End of Virtual Account	</VrtlAcct>
Consolidated Information	<CnsltdInf>
Group of Account Name	<GOANm></GOANm>
Group of Accounts ID	<GOAId></GOAId>
Main Account of GoA	<MainAcct></MainAcct>
End of Consolidated Information	</CnsltdInf>
Banking Group Monitoring	<BGM>
Group of Account Name	<GOANm></GOANm>
Group of Accounts ID	<GOAId></GOAId>
Main Account of GoA	<MainAcct></MainAcct>
End of Banking Group Monitoring	</BGM>
End of Pooling of liquidity	</PoolgLqdy>
T2S related push messages	<T2SRelPshMsg>
LiquidityTransfersFromT2S	<LtrFrT2S>
Message Format	<MTMXMsg></MTMXMsg>
DN for Push Mode	<DN></DN>
End of LiquidityTransfersFromT2S	</LtrFrT2S>
T2S Debit Notifications	<T2SDbtNtfctn>
Message Format	<MTMXMsg></MTMXMsg>
DN for Push Mode	<DN></DN>
End of T2S Debit Notifications	</T2SDbtNtfctn>
End of T2S related push messages	</T2SRelPshMsg>
End of RTGS Account	</RTGSAcct>
End of BusinessReport	</BizRpt>
OperationalError	<OprlErr>
Error handling	<Err>
Proprietary error code	<Prtry></Prtry>
End error handling	</Err>
Description	<Desc></Desc>
End of Operational Error	</OprlErr>
End of choice	</xorBizRptOprlErr>
End of Message Type	</ReturnRTGSAccount>
End of SSP Proprietary Data	</SspPrtryDt>
End of Proprietary Data	</Data>
End of Proprietary Data	</PrtryData>
End proprietary message	</PrtryMsg>

Attributes:

name of attribute	format	short description	description
<PrtryMsg>		Name Proprietary message Mandatory	Validation:
<MsgHdr>		Message Header Mandatory	Set of characteristics specific to the message Validation: [1..1]
<MsgId></MsgId>	35x	Message Identification Mandatory	Message Identification Validation: [1..1]
</MsgHdr>		End of Message Header Mandatory	Validation: [1..1]
<Rltd>		Related Optional	References a previously received message. Validation: [0..1]
<Ref></Ref>	35x	Reference Mandatory	Unique and unambiguous reference Validation: [1..1]
</Rltd>		End of Related Optional	End of Related Validation: [0..1]
<PrtryData>		Proprietary Data Mandatory	Proprietary Data Validation: [1..1]
<Tp></Tp>	35x	Proprietary Data type Mandatory	Proprietary Data type defines the Type of the free format XML Validation: [1..1]
<Data>		Proprietary Data Mandatory	Proprietary data content Validation: [1..1]
<SspPrtryDt>		SSP Proprietary Data Mandatory	Root element for all SSP proprietary data Validation: [1..1]
<ReturnRTGSAccount>		Message Type Mandatory	Message Type for Static Data Validation: [1..1]
xorBizRptOpriErr		Choice amongst	Choice amongst xorBizRptOpriErr (Type: xor)

name of attribute	format	short description	description
		Optional	Validation:
<BizRpt>		BusinessReport	BusinessReport Rule rationale: The message will contain either the information matching the search criteria of the related Get message or an error indication. Rule description: If BusinessReport is present then OperationalError is not allowed. If BusinessReport is not present, then OperationalError is mandatory.
		Mandatory	Validation: [1..1]
<RTGSAcct>		RTGS Account	RTGS Account
		Mandatory	Validation: [1..1]
<PtcptInf>		Participant Information	Participant Information
		Mandatory	Validation: [1..1]
<PtcptNm1>-</PtcptNm1>	35x	Participant Name1	Participant Name, first line.
		Mandatory	Validation: [1..1]
<BIC>-</BIC>	4!a2!a2!c3!c	BIC	A code allocated to a financial institution by a Registration Authority under an international identification scheme, as described in the latest edition of the international standard ISO 9362 "Banking - Banking telecommunication messages - Bank identifier codes". BIC 11 of the RTGS Account Holder (BIC Participant).
		Mandatory	Validation: [1..1]
<BICAddss>-</BICAddss>	4!a2!a2!c3!c]	BIC Addressee	A code allocated to a financial institution by a Registration Authority under an international identification scheme, as described in the latest edition of the international standard ISO 9362 "Banking - Banking telecommunication messages - Bank identifier codes". In this case, this is the Addressee BIC (BIC 11).
		Optional	Validation: [0..1]
<NSC>-</NSC>	15n	National Sorting Code	Code present in the BIC DATA +. Character string with a max length of 15 characters.
		Optional	Validation: [0..1]
</PtcptInf>		End of Participant Information	End of Participant Information
		Mandatory	Validation: [1..1]
<RecStsInf>		Record Status Information	Record Status Information
		Mandatory	Validation: [1..1]

name of attribute	format	short description	description
<PlndChng>-</PlndChng>	1!a	Planned Change	<p>Information on record regarding the presence of a future record. Values may be :</p> <p>"N" if no future record is present "D" if the record will be deleted "M" if a future record exists</p> <p>Note : the Planned Change flag has been added in order to help users when displaying an active record. Actually, for an active record with an End Date different from '9999-12-31', it is not possible to know whether the related record will be deleted (when the system reach the End Date) or if a future record exists and will be active, as a substitute for the active one.</p> <p>The use of the Planned Change flag is made to have information on the future of an active record.</p> <p style="text-align: right;">Mandatory</p> <p>Validation: [1..1]</p>
<RecSts>-</RecSts>	2x	Record Status	<p>Status of the record. List of values :</p> <p>"AC" for Active "FU" for Future "RE" for Rejected "AR" for Archived "AF" for Archived Future "IC" for In Change "DV" for Delivery (Technical) "ID" for In Deletion (Technical)</p> <p>For more information on status management, refer to the ICM UserHandBook.</p> <p style="text-align: right;">Mandatory</p> <p>Validation: [1..1]</p>
<FrstDt>-</FrstDt>	ISODate	First Activation Date	<p>Date within a particular calendar year represented by YYYY-MM-DD (ISO 8601). This date represents the first activation date of a functional item, such as a Participant. It is different from the modification date, which is the last date when a modification occurred.</p> <p style="text-align: right;">Mandatory</p> <p>Validation: [1..1]</p>
<ModDt>-</ModDt>	ISODate	Modification Date	<p>Date within a particular calendar year represented by YYYY-MM-DD (ISO 8601).</p> <p>This is the modification date of the related record. If the record has not been modified since its activation, the modification date is equal to the first activation date.</p> <p style="text-align: right;">Mandatory</p> <p>Validation: [1..1]</p>
<EndDt>-</EndDt>	ISODate	End Date	<p>Date within a particular calendar year represented by YYYY-MM-DD (ISO 8601).</p> <p>This is the end date of the related record. Value is equal to '9999-12-31' if no modification or deletion are foreseen for this record. Otherwise, the End Date takes the value of the modification date or date of the deletion.</p> <p style="text-align: right;">Optional</p> <p>Validation: [0..1]</p>
</RecStsInf>		End of Record Status Information	<p>End of Record Status Information</p> <p style="text-align: right;">Mandatory</p> <p>Validation:</p>

name of attribute	format	short description	description
			[1..1]
<AcctInf>		Account Information	Account Information
		Mandatory	Validation: [1..1]
<RTGSAcctNb>- </RTGSAcctNb>	2!c32x	RTGS Account Number	Account Number. Length 34 characters. First two characters represent the country code of the responsible CB.
		Mandatory	Validation: [1..1]
<RTGSAcctTp>- </RTGSAcctTp>	3x	RTGS Account Type	Indicates the type of RTGS Account. Values may be : "CI" for Credit Institution Account "CB" for Central Bank Account "LB" for CB Customer Liquidity Bridge Account (technical) "SFI" for Standing Facilities Interests Account (for CB only) "RIP" for RM interests and penalty Account (for CB only) "T2F" for Target 2 Fees Account (for CB only) "EC" for ECB Account (Technical) "ECM" for ECB Mirror Account (Technical) "IL" for SSP Interlinking Account (Technical) "ASM" for Ancillary System Technical account - procedure 6 real-time "AST" for Ancillary System Technical Account (Technical) "ASG" for Ancillary System Guarantee Account "CM" for Contingency Module Account (Technical) "T2S" for T2S Transit Account (Technical)
		Mandatory	Validation: [1..1]
<AcceptAdv>-</AcceptAdv>	1!a	Accept MT900/910	For RTGS Account : A flag with two values : 'Y' or 'N'. 'Y' means that the account holder will receive an advice (MT900 or MT910) for each debit/credit of the related RTGS Account. 'N' means that the account holder refuses to receive notification of debit/credit.
		Mandatory	Validation: [1..1]
<BalRpt>-</BalRpt>	3!n	Balance Report	This is the Swift message type for Balance Report. List of values : "940", "950" or "none"
		Optional	Validation: [0..1]
<MaxAmtDay>-	18!d	Maximum Amount per day	Maximum Amount per day in case of Direct Debit. Amount, made of a maximum of 17 numbers and one digit (decimal coma)
		Optional	Validation: [0..1]
<CdtsBsd>-</CdtsBsd>	1!a	Credit Based Only	A flag with two values : 'Y' or 'N'. Used to indicate whether the related RTGS Account may have an uncovered negative balance (value is 'N') or not (value is 'Y').
		Mandatory	Validation: [1..1]
<CtncyAcctNb>- </CtncyAcctNb>	2!c32x	Contingency Account Number	Account Code. Length 34 characters

name of attribute	format	short description	description
		Mandatory	Validation: [1..1]
</AcctInf>		End of Account Information	End of Account Information
		Mandatory	Validation: [1..1]
<LqdyMgmt>		Liquidity Management	Liquidity Management
		Optional	Validation: [0..1]
<DayLght>		During the Day	Liquidity Management During the Day
		Optional	Validation: [0..1]
<BICLqdyRmvDaylght>- </BICLqdyRmvDaylght>	4!a2!a2!c[3! c]	Receiver BIC for Liq Removal Daylight	A code allocated to a financial institution by a Registration Authority under an international identification scheme, as described in the latest edition of the international standard ISO 9362 "Banking - Banking telecommunication messages - Bank identifier codes". In this case, this is the BIC 11 used for the liquidity removal during the day.
		Optional	Validation: [0..1]
<AcctLqdyRmvDaylight>- </AcctLqdyRmvDaylight>	34x	Account for Liq Removal Daylight	Account Code. Lengh 34 characters
		Optional	Validation: [0..1]
</DayLght>		End of During the Day	End of During the Day
		Optional	Validation: [0..1]
<EoD>		End of Day	Liquidity Management : End of Day
		Optional	Validation: [0..1]
<BICLqdyRmvEoD>- </BICLqdyRmvEoD>	4!a2!a2!c[3! c]	Receiver BIC for Liq Removal EoD	A code allocated to a financial institution by a Registration Authority under an international identification scheme, as described in the latest edition of the international standard ISO 9362 "Banking - Banking telecommunication messages - Bank identifier codes". In this case, this is the BIC 11 for liquidity removal at the end of day.
		Optional	Validation: [0..1]
<AcctLqdyRmvEoD>- </AcctLqdyRmvEoD>	34x	Account for Liq Removal EoD	Account Code. Lengh 34 characters
		Optional	Validation: [0..1]

name of attribute	format	short description	description
</EoD>		End of End of Day	End of End of Day
		Optional	Validation: [0..1]
</LqdyMgmt>		End of Liquidity Management	End of Liquidity Management
		Optional	Validation: [0..1]
<PoolgLqdy>		Pooling of liquidity	Pooling of liquidity (Group of Accounts)
		Optional	Validation: [0..1]
<VrtlAcct>		Virtual Account	Virtual Account
		Optional	Validation: [0..1]
<GOANm>-</GOANm>	35x	Group of Account Name	Group of Account Name
		Optional	Validation: [0..1]
<GOAId>-</GOAId>	12x	Group of Accounts ID	Group of Accounts ID. Lenght 12 characters.
		Optional	Validation: [0..1]
<MainAcct>-</MainAcct>	4!a2!a2!c[3! c]	Main Account of GoA	A code allocated to a financial institution by a Registration Authority under an international identification scheme, as described in the latest edition of the international standard ISO 9362 "Banking - Banking telecommunication messages - Bank identifier codes". In this case, this is the BIC 11 identifying the main account of a Group of Accounts.
		Optional	Validation: [0..1]
</VrtlAcct>		End of Virtual Account	End of Virtual Account
		Optional	Validation: [0..1]
<CnsltdInf>		Consolidated Information	Consolidated Information Group of Account
		Optional	Validation: [0..1]
<GOANm>-</GOANm>	35x	Group of Account Name	Group of Account Name
		Optional	Validation: [0..1]
<GOAId>-</GOAId>	12x	Group of Accounts ID	Group of Accounts ID. Lenght 12 characters.
		Optional	Validation: [0..1]
<MainAcct>-</MainAcct>	4!a2!a2!c[3! c]	Main Account of GoA	A code allocated to a financial institution by a Registration Authority under an international identification scheme, as described in the latest edition of the international standard ISO 9362 "Banking - Banking telecommunication messages - Bank identifier

name of attribute	format	short description	description
			codes". In this case, this is the BIC 11 identifying the main account of a Group of Accounts.
		Optional	Validation: [0..1]
</CnsltdInf>		End of Consolidated Information Optional	End of Consolidated Information Validation: [0..1]
<BGM>		Banking Group Monitoring Optional	Banking Group Monitoring Validation: [0..1]
<GOANm>-</GOANm>	35x	Group of Account Name Optional	Group of Account Name Validation: [0..1]
<GOAId>-</GOAId>	12x	Group of Accounts ID Optional	Group of Accounts ID. Length 12 characters. Validation: [0..1]
<MainAcct>-</MainAcct>	4!a2!a2!c[3!c]	Main Account of GoA Optional	A code allocated to a financial institution by a Registration Authority under an international identification scheme, as described in the latest edition of the international standard ISO 9362 "Banking - Banking telecommunication messages - Bank identifier codes". In this case, this is the BIC 11 identifying the main account of a Group of Accounts. Validation: [0..1]
</BGM>		End of Banking Group Monitoring Optional	End of Banking Group Monitoring Validation: [0..1]
</PoolgLqdy>		End of Pooling of liquidity Optional	End of Pooling of liquidity Validation: [0..1]
<T2SRelPshMsg>		T2S related push messages Optional	Validation: [0..1]
<LtrFrT2S>		LiquidityTransfersFromT2S Optional	Validation: [0..1]
<MTMXMsg>-</MTMXMsg>	2!a	Message Format Optional	A list with two values : 'MT' or 'MX' indicates the participant has opted for message format MT or MX. Validation: [0..1]
<DN>-</DN>	100x	DN for Push Mode	Distinguished Name, made of max 100 characters (for push mode functionalities).

name of attribute	format	short description	description
		Optional	Validation: [0..1]
</LtrFrT2S>		End of LiquidityTransfersFromT2S Optional	Validation: [0..1]
<T2SdbtNtfctn>		T2S Debit Notifications Optional	Validation: [0..1]
<MTMXMsg>-</MTMXMsg>	2!a	Message Format Optional	A list with two values : 'MT' or 'MX' indicates the participant has opted for message format MT or MX. Validation: [0..1]
<DN>-</DN>	100x	DN for Push Mode Optional	Distinguished Name, made of max 100 characters (for push mode functionalities). Validation: [0..1]
</T2SdbtNtfctn>		End of T2S Debit Notifications Optional	Validation: [0..1]
</T2SRelPshMsg>		End of T2S related push messages Optional	Validation: [0..1]
</RTGSAcct>		End of RTGS Account Mandatory	End of RTGS Account Validation: [1..1]
</BizRpt>		End of BusinessReport Mandatory	End of BusinessReport Validation: [1..1]
<OpriErr>		OperationalError Mandatory	Rule rationale: The message will contain either the information matching the search criteria of the related Get message or an error indication. Rule description: If BusinessReport is present then OperationalError is not allowed. If BusinessReport is not present, then OperationalError is mandatory. Separate Specification see UDFS books regarding error codes Validation: [1..1]
<Err>		Error handling Mandatory	Validation: [1..1]
<Prtry>-</Prtry>	4x	Proprietary error code Mandatory	Specification of the error, in free format. Validation: [1..1]

name of attribute	format	short description	description
</Err>		End error handling Mandatory	Validation: [1..1]
<Desc>-</Desc>	140x	Description Optional	Specification of the error, in free format. Validation: [0..1]
</OpriErr>		End of Operational Error Mandatory	End of Operational Error Validation: [1..1]
/xorBizRptOpriErr		End of choice Optional	End of Choice Validation:
</ReturnRTGSAccount>		End of Message Type Mandatory	End of Message Type for Static Data Validation: [1..1]
</SspPrtryDt>		End of SSP Proprietary Data Mandatory	End of Root element for all SSP proprietary data Validation: [1..1]
</Data>		End of Proprietary Data Mandatory	Validation: [1..1]
</PrtryData>		End of Proprietary Data Mandatory	End of Proprietary Data Validation: [1..1]
</PrtryMsg>		End proprietary message Mandatory	Validation:

Error Codes:

ReturnRTGSAccount_SD_1

Scope: Response to the XML GetRTGSAccount

Name Proprietary message	<PrtryMsg>
Message Header	<MsgHdr>
Message Identification	<MsgId>RETURNABC123</MsgId>
End of Message Header	</MsgHdr>
Related	<Rltd>
Reference	<Ref>ABC123</Ref>
End of Related	</Rltd>
Proprietary Data	<PrtryData>
Proprietary Data type	<Tp>ReturnRTGSAccount</Tp>
Proprietary Data	<Data>
SSP Proprietary Data	<SspPrtryDt>
Message Type	<ReturnRTGSAccount>
BusinessReport	<BizRpt>
RTGS Account	<RTGSAcct>
Participant Information	<PtcptInf>
Participant Name1	<PtcptNm1>SDMFESPA001 UPD</PtcptNm1>
BIC	<BIC>SDMFESPA001</BIC>
BIC Addressee	<BICAddss>SDMFESPA001</BICAddss>
National Sorting Code	<NSC>123456789</NSC>
End of Participant Information	</PtcptInf>
Record Status Information	<RecStsInf>
Planned Change	<PlnndChng>N</PlnndChng>
Record Status	<RecSts>AC</RecSts>
First Activation Date	<FrstDt>2008-08-18</FrstDt>
Modification Date	<ModDt>2012-04-18</ModDt>
End Date	<EndDt>9999-12-31</EndDt>
End of Record Status Information	</RecStsInf>
Account Information	<AcctInf>
RTGS Account Number	<RTGSAcctNb>ESSDMFESPA001</RTGSAcctNb>
RTGS Account Type	<RTGSAcctTp>Cl</RTGSAcctTp>
Accept MT900/910	<AccptAdv>N</AccptAdv>
Maximum Amount per day	<MaxAmtDay>0.00</MaxAmtDay>
Credit Based Only	<CdtsBsd>Y</CdtsBsd>
Contingency Account Number	<CtgnncyAcctNb>ESSDMFESPA001</CtgnncyAcctNb>
End of Account Information	</AcctInf>
Liquidity Management	<LqdyMgmt>
During the Day	<DayLght>
Receiver BIC for Liq Removal Daylight	<BICLqdyRmvlDaylght>ZYAJFRT0HCB</BICLqdyRmvlDaylght>
End of During the Day	</DayLght>
End of Day	<EoD>
Receiver BIC for Liq Removal EoD	<BICLqdyRmvlEoD>ZYAJFRT0HCB</BICLqdyRmvlEoD>
End of End of Day	</EoD>
End of Liquidity Management	</LqdyMgmt>
Pooling of liquidity	<PoolgLqdy>
Virtual Account	<VrtlAcct>
Group of Account Name	<GOANm>CRMFRVABE</GOANm>
Group of Accounts ID	<GOAId>CRMFRVABE</GOAId>
Main Account of GoA	<MainAcct>ZYAJFRT0BS5</MainAcct>

End of Virtual Account										</VrtlAcct>
Consolidated Information										<CnsltdInf>
Group of Account Name										<GOANm>CRMFRVCIBEC</GOANm>
Group of Accounts ID										<GOAId>CRMFRVCIBEC</GOAId>
Main Account of GoA										<MainAcct>ZYAJFRT0BS5</MainAcct>
End of Consolidated Information										</CnsltdInf>
End of Pooling of liquidity										</PoolgLqdy>
T2S related push messages										<T2SRelPshMsg>
LiquidityTransfersFromT2S										<LtrfFrT2S>
Message Format										<MTXMMsg>MT</MTXMMsg>
End of LiquidityTransfersFromT2S										</LtrfFrT2S>
T2S Debit Notifications										<T2SDbtNfctn>
Message Format										<MTXMMsg>MX</MTXMMsg>
DN for Push Mode										<DN>cn=hcb2,ou=hcb,ou=tssp,ou=unit-dev-2003,o=bdfefrpp,o=swift</DN>
End of T2S Debit Notifications										</T2SDbtNfctn>
End of T2S related push messages										</T2SRelPshMsg>
End of RTGS Account										</RTGSAcct>
End of BusinessReport										</BizRpt>
End of Message Type										</ReturnRTGSAccount>
End of SSP Proprietary Data										</SspPrtryDt>
End of Proprietary Data										</Data>
End of Proprietary Data										</PrtryData>
End proprietary message										</PrtryMsg>

ReturnRTGSAccount_SD_2

Scope: Error message Response to an XML GetRTGSAccount request

Name Proprietary message	<PrtryMsg>
Message Header	<MsgHdr>
Message Identification	<MsgId>RETURNABC123</MsgId>
End of Message Header	</MsgHdr>
Related	<Rltd>
Reference	<Ref>ABC123</Ref>
End of Related	</Rltd>
Proprietary Data	<PrtryData>
Proprietary Data type	<Tp>ReturnRTGSAccount</Tp>
Proprietary Data	<Data>
SSP Proprietary Data	<SspPrtryDt>
Message Type	<ReturnRTGSAccount>
OperationalError	<OprlErr>
Error handling	<Err>
Proprietary error code	<Prtry>S100</Prtry>
End error handling	</Err>
Description	<Desc>No data available for selected criteria - No record for a RTGS owned by SDMFESPA001</Desc>
End of Operational Error	</OprlErr>
End of Message Type	</ReturnRTGSAccount>
End of SSP Proprietary Data	</SspPrtryDt>
End of Proprietary Data	</Data>
End of Proprietary Data	</PrtryData>
End proprietary message	</PrtryMsg>

6. 5.45ReturnSFAccount

SSP Proprietary Messages

ReturnSFAccount_SD

Scope: This is the response to the XML Request : GetSFAccount

<camt.998.001.xx>

Structure:

Name Proprietary message	<PrtryMsg>
Message Header	<MsgHdr>
Message Identification	<MsgId></MsgId>
End of Message Header	</MsgHdr>
Related	<Rltd>
Reference	<Ref></Ref>
End of Related	</Rltd>
Proprietary Data	<PrtryData>
Proprietary Data type	<Tp>ReturnSFAccount</Tp>
Proprietary Data	<Data>
SSP Proprietary Data	<SspPrtryDt>
Message Type	<ReturnSFAccount>
Choice amongst	<xorBizRptOprlErr>
BusinessReport	<BizRpt>
SF Account	<StgFcltsAcct>
Participant Information	<PtcptInf>
Participant Name1	<PtcptNm1></PtcptNm1>
BIC	<BIC></BIC>
BIC Addressee	<BICAddss></BICAddss>
National Sorting Code	<NSC></NSC>
End of Participant Information	</PtcptInf>
Record Status Information	<RecStsInf>
Planned Change	<PlnndChng></PlnndChng>
Record Status	<RecSts></RecSts>
First Activation Date	<FrstDt></FrstDt>
Modification Date	<ModDt></ModDt>
End Date	<EndDt></EndDt>
End of Record Status Information	</RecStsInf>
Account Information	<AcctInf>
SF Account Number Marginal Lending	<StgFcltsAcctNbMgld></StgFcltsAcctNbMgld>
SF Account Number Overnight Deposit	<StgFcltsAcctNbOnDp></StgFcltsAcctNbOnDp>
Module of Settlement for SF Accounts	<MdleSettl></MdleSettl>
Settlement Account Number	<StlmAcctNb></StlmAcctNb>
End of Account Information	</AcctInf>
End of SF Account	</StgFcltsAcct>
End of BusinessReport	</BizRpt>
OperationalError	<OprlErr>
Error handling	<Err>
Proprietary error code	<Prtry></Prtry>
End error handling	</Err>
Description	<Desc></Desc>
End of Operational Error	</OprlErr>
End of choice	</xorBizRptOprlErr>
End of Message Type	</ReturnSFAccount>

End of SSP Proprietary Data
End of Proprietary Data
End of Proprietary Data
End proprietary message

```
| | | </SspPrtryDt>  
| | </Data>  
| </PrtryData>  
</PrtryMsg>
```

Attributes:

name of attribute	format	short description	description
<PrtryMsg>		Name Proprietary message Mandatory	Validation:
<MsgHdr>		Message Header Mandatory	Set of characteristics specific to the message BIC 11 of the Standing Facilities Account Holder (BIC Participant). Validation: [1..1]
<MsgId>-</MsgId>	35x	Message Identification Mandatory	Message Identification Validation: [1..1]
</MsgHdr>		End of Message Header Mandatory	Validation: [1..1]
<Rltd>		Related Optional	References a previously received message. Validation: [0..1]
<Ref>-</Ref>	35x	Reference Mandatory	Unique and unambiguous reference Validation: [1..1]
</Rltd>		End of Related Optional	End of Related Validation: [0..1]
<PrtryData>		Proprietary Data Mandatory	Proprietary Data Validation: [1..1]
<Tp>-</Tp>	35x	Proprietary Data type Mandatory	Proprietary Data type defines the Type of the free format XML Validation: [1..1]
<Data>		Proprietary Data Mandatory	Proprietary data content Validation: [1..1]
<SspPrtryDt>		SSP Proprietary Data Mandatory	Root element for all SSP proprietary data Validation: [1..1]
<ReturnSFAccount>		Message Type Mandatory	Message Type for Static Data Validation: [1..1]
xorBizRptOprlErr		Choice amongst	Choice amongst xorBizRptOprlErr (Type: xor)

name of attribute	format	short description	description
		Optional	Validation:
<BizRpt>		BusinessReport	BusinessReport Rule rationale: The message will contain either the information matching the search criteria of the related Get message or an error indication. Rule description: If BusinessReport is present then OperationalError is not allowed. If BusinessReport is not present, then OperationalError is mandatory.
		Mandatory	Validation: [1..1]
<StgFcltsAcct>		SF Account	SF Account
		Mandatory	Validation: [1..1]
<PtcptInf>		Participant Information	Participant Information
		Mandatory	Validation: [1..1]
<PtcptNm1>-</PtcptNm1>	35x	Participant Name1	Participant Name, first line.
		Mandatory	Validation: [1..1]
<BIC>-</BIC>	4!a2!a2!c3!c	BIC	A code allocated to a financial institution by a Registration Authority under an international identification scheme, as described in the latest edition of the international standard ISO 9362 "Banking - Banking telecommunication messages - Bank identifier codes". In this case, this is the BIC 11 of the Participant
		Mandatory	Validation: [1..1]
<BICAddss>-</BICAddss>	4!a2!a2!c3!c]	BIC Addressee	A code allocated to a financial institution by a Registration Authority under an international identification scheme, as described in the latest edition of the international standard ISO 9362 "Banking - Banking telecommunication messages - Bank identifier codes". In this case, this is the Addressee BIC (BIC 11).
		Optional	Validation: [0..1]
<NSC>-</NSC>	15n	National Sorting Code	Code present in the BIC DATA +. Character string with a max length of 15 characters.
		Optional	Validation: [0..1]
</PtcptInf>		End of Participant Information	End of Participant Information
		Mandatory	Validation: [1..1]
<RecStsInf>		Record Status Information	Record Status Information
		Mandatory	Validation: [1..1]

name of attribute	format	short description	description
<PlndChng>-</PlndChng>	1!a	Planned Change	<p>Information on record regarding the presence of a future record. Values may be :</p> <p>"N" if no future record is present "D" if the record will be deleted "M" if a future record exists</p> <p>Note : the Planned Change flag has been added in order to help users when displaying an active record. Actually, for an active record with an End Date different from '9999-12-31', it is not possible to know whether the related record will be deleted (when the system reach the End Date) or if a future record exists and will be active, as a substitute for the active one.</p> <p>The use of the Planned Change flag is made to have information on the future of an active record.</p> <p style="text-align: right;">Mandatory</p> <p style="text-align: right;">Validation: [1..1]</p>
<RecSts>-</RecSts>	2x	Record Status	<p>Status of the record. List of values :</p> <p>"AC" for Active "FU" for Future "RE" for Rejected "AR" for Archived "AF" for Archived Future "IC" for In Change "DV" for Delivery (Technical) "ID" for In Deletion (Technical)</p> <p>For more information on status management, refer to the ICM UserHandBook.</p> <p style="text-align: right;">Mandatory</p> <p style="text-align: right;">Validation: [1..1]</p>
<FrstDt>-</FrstDt>	ISODate	First Activation Date	<p>Date within a particular calendar year represented by YYYY-MM-DD (ISO 8601). This date represents the first activation date of a functional item, such as a Participant. It is different from the modification date, which is the last date when a modification occurred.</p> <p style="text-align: right;">Mandatory</p> <p style="text-align: right;">Validation: [1..1]</p>
<ModDt>-</ModDt>	ISODate	Modification Date	<p>Date within a particular calendar year represented by YYYY-MM-DD (ISO 8601).</p> <p>This is the modification date of the related record. If the record has not been modified since its activation, the modification date is equal to the first activation date.</p> <p style="text-align: right;">Mandatory</p> <p style="text-align: right;">Validation: [1..1]</p>
<EndDt>-</EndDt>	ISODate	End Date	<p>Date within a particular calendar year represented by YYYY-MM-DD (ISO 8601).</p> <p>This is the end date of the related record. Value is equal to '9999-12-31' if no modification or deletion are foreseen for this record. Otherwise, the End Date takes the value of the modification date or date of the deletion.</p> <p style="text-align: right;">Mandatory</p> <p style="text-align: right;">Validation: [1..1]</p>
</RecStsInf>		End of Record Status Information	<p>End of Record Status Information</p> <p style="text-align: right;">Mandatory</p> <p style="text-align: right;">Validation: [1..1]</p>

name of attribute	format	short description	description
			[1..1]
<AcctInf>		Account Information	Account Information
		Mandatory	Validation: [1..1]
<StgFcltsAcctNbMgLd>-</StgFcltsAcctNbMgLd>	2!c32x	SF Account Number Marginal Lending	Account Code. Lenght 34 characters
		Optional	Validation: [0..1]
<StgFcltsAcctNbOnDp>-</StgFcltsAcctNbOnDp>	2!c32x	SF Account Number Overnight Deposit	Account Code. Lenght 34 characters
		Mandatory	Validation: [1..1]
<MdleSettl>-</MdleSettl>	4c	Module of Settlement for SF Accounts	Module of Settlement for SF Accounts. List of allowed values is : - RTGS - HAM
		Mandatory	Validation: [1..1]
<SttlmAcctNb>-</SttlmAcctNb>	2!c32x	Settlement Account Number	Account Code. Lenght 34 characters
		Mandatory	Validation: [1..1]
</AcctInf>		End of Account Information	End of Account Information
		Mandatory	Validation: [1..1]
</StgFcltsAcct>		End of SF Account	End of SF Account
		Mandatory	Validation: [1..1]
</BizRpt>		End of BusinessReport	End of BusinessReport
		Mandatory	Validation: [1..1]
<OprlErr>		OperationalError	Rule rationale: The message will contain either the information matching the search criteria of the related Get message or an error indication. Rule description: If BusinessReport is present then OperationalError is not allowed. If BusinessReport is not present, then OperationalError is mandatory. Separate Specification see UDFS books regarding error codes
		Mandatory	Validation: [1..1]
<Err>		Error handling	
		Mandatory	Validation: [1..1]
<Prtry>-</Prtry>	4x	Proprietary error code	Specification of the error, in free format.
		Mandatory	Validation: [1..1]

name of attribute	format	short description	description
</Err>		End error handling Mandatory	Validation: [1..1]
<Desc>-</Desc>	140x	Description Optional	Specification of the error, in free format. Validation: [0..1]
</OpriErr>		End of Operational Error Mandatory	End of Operational Error Validation: [1..1]
/xorBizRptOpriErr		End of choice Optional	End of Choice Validation:
</ReturnSFAccount>		End of Message Type Mandatory	End of Message Type for Static Data Validation: [1..1]
</SspPrtryDt>		End of SSP Proprietary Data Mandatory	End of Root element for all SSP proprietary data Validation: [1..1]
</Data>		End of Proprietary Data Mandatory	Validation: [1..1]
</PrtryData>		End of Proprietary Data Mandatory	End of Proprietary Data Validation: [1..1]
</PrtryMsg>		End proprietary message Mandatory	Validation:

Error Codes:

ReturnSFAccount_SD_1

Scope: This is the response to the XML Request : GetSFAccount

Name Proprietary message	<PrtryMsg>
Message Header	<MsgHdr>
Message Identification	<Msgld>1358869045118816561673</Msgld>
End of Message Header	</MsgHdr>
Related	<Rltd>
Reference	<Ref>GETSFACCWB01</Ref>
End of Related	</Rltd>
Proprietary Data	<PrtryData>
Proprietary Data type	<Tp>ReturnSFAccount</Tp>
Proprietary Data	<Data>
SSP Proprietary Data	<SspPrtryDt>
Message Type	<ReturnSFAccount>
BusinessReport	<BizRpt>
SF Account	<StgFcltsAcct>
Participant Information	<PtcptInf>
Participant Name1	<PtcptNm1>ZYAJFRT0HZ2</PtcptNm1>
BIC	<BIC>ZYAJFRT0HZ2</BIC>
BIC Addressee	<BICAddss>ZYAJFRT0HZ2</BICAddss>
End of Participant Information	</PtcptInf>
Record Status Information	<RecStsInf>
Planned Change	<PlnndChng>N</PlnndChng>
Record Status	<RecSts>AC</RecSts>
First Activation Date	<FrstDt>2013-01-18</FrstDt>
Modification Date	<ModDt>2013-01-18</ModDt>
End Date	<EndDt>9999-12-31</EndDt>
End of Record Status Information	</RecStsInf>
Account Information	<AcctInf>
SF Account Number Marginal Lending	<StgFcltsAcctNbMgLd>ESZYAJFRT0HZ2ml</StgFcltsAcctNbMgLd>
SF Account Number Overnight Deposit	<StgFcltsAcctNbOnDp>ESZYAJFRT0HZ2od</StgFcltsAcctNbOnDp>
Module of Settlement for SF Accounts	<MdleSettl>RTGS</MdleSettl>
Settlement Account Number	<SttlmAcctNb>ESZYAJFRT0HZ2</SttlmAcctNb>
End of Account Information	</AcctInf>
End of SF Account	</StgFcltsAcct>
End of BusinessReport	</BizRpt>
End of Message Type	</ReturnSFAccount>
End of SSP Proprietary Data	</SspPrtryDt>
End of Proprietary Data	</Data>
End of Proprietary Data	</PrtryData>
End proprietary message	</PrtryMsg>

ReturnSFAccount_SD_2

Scope: This is the error response to the XML Request : GetSFAccount

Name Proprietary message	<PrtryMsg>
Message Header	<MsgHdr>
Message Identification	<MsgId>1358869045118816561673</MsgId>
End of Message Header	</MsgHdr>
Related	<Rltd>
Reference	<Ref>GETSFACCWB02</Ref>
End of Related	</Rltd>
Proprietary Data	<PrtryData>
Proprietary Data type	<Tp>ReturnSFAccount</Tp>
Proprietary Data	<Data>
SSP Proprietary Data	<SspPrtryDt>
Message Type	<ReturnSFAccount>
OperationalError	<OpriErr>
Error handling	<Err>
Proprietary error code	<Prtry>S100</Prtry>
End error handling	</Err>
Description	<Desc>No data available for selected criteria - No record for a sf owned by ZYAJFRT0HW1</Desc>
End of Operational Error	</OpriErr>
End of Message Type	</ReturnSFAccount>
End of SSP Proprietary Data	</SspPrtryDt>
End of Proprietary Data	</Data>
End of Proprietary Data	</PrtryData>
End proprietary message	</PrtryMsg>

6. 5.46 ReturnStandingOrderMirror

SSP Proprietary Messages

ReturnStandingOrderMirror_SD

Scope: This message is used to return the requested standing orders via GetStandingOrderMirror

<camt.998.001.xx>

Structure:

Name Proprietary message	<PrtryMsg>
Message Header	<MsgHdr>
Message Identification	<MsgId></MsgId>
End of Message Header	</MsgHdr>
Related	<Rltd>
Reference	<Ref></Ref>
End of Related	</Rltd>
Proprietary Data	<PrtryData>
Proprietary Data type	<Tp>ReturnStandingOrderMirror</Tp>
Proprietary Data	<Data>
SSP Proprietary Data	<SspPrtryDt>
Message type for static data	<ReturnStandingOrderMirror>
choice	xorBizRptOprlErr
BusinessReport	<BizRpt>
Identification of the standing order	<StgOrdrlId>
Participant Identification	<PtcptId>
BIC	<BIC></BIC>
Name of settlement bank first	<PtcptNm></PtcptNm>
End of Participant Identification	</PtcptId>
Account Identification	<AcctId>
Simple Identification Information	<DmstAcct>
Identification	<Id></Id>
End of simple Identification Information	</DmstAcct>
End of Account Identification	</AcctId>
End of Standing order Id	</StgOrdrlId>
List of the standing orders	<StgOrdrValSet>
Identification of the standing order	<StgMirrorId></StgMirrorId>
Amount	<Amt>
Amount without currency	<AmtWthtCcy></AmtWthtCcy>
End of Amount	</Amt>
Debtor	<Dbtr>
Financial institution	<FI>
BIC	<BIC></BIC>
End of financial institution	</FI>
End of debtor	</Dbtr>
Creditor	<Cdtr>
Financial institution	<FI>
BIC	<BIC></BIC>
End of financial institution	</FI>
End of Creditor	</Cdtr>
CreditorAccount	<CdtrAcct>
Simple Identification Information	<DmstAcct>
Identification	<Id></Id>
End of simple Identification Information	</DmstAcct>

EndCreditorAccount	</CdtrAcct>
Final Agent	<FnlAgt>
BIC	<BIC></BIC>
End of Final Agent	</FnlAgt>
RemittanceInformation	<RmtInf>
Unstructured	<Ustrd></Ustrd>
EndRemittanceInformation	</RmtInf>
Frequency	<Frqcy></Frqcy>
List of the standing orders (End)	</StgOrdValSet>
End of BusinessReport	</BizRpt>
OperationalError	<OprlErr>
Error handling	<Err>
Proprietary error code	<Prtry></Prtry>
End error handling	</Err>
Description	<Desc></Desc>
End of Operational Error	</OprlErr>
End of choice	/xorBizRptOprlErr
message type for static data (end)	</ReturnStandingOrderMirror>
End of SSP Proprietary Data	</SspPrtryDt>
End of Proprietary Data	</Data>
End of Proprietary Data	</PrtryData>
End proprietary message	</PrtryMsg>

Attributes:

name of attribute	format	short description	description
<PrtryMsg>		Name Proprietary message Mandatory	Validation: [1..1]
<MsgHdr>		Message Header Mandatory	Set of characteristics specific to the message Validation: [1..1]
<MsgId>-</MsgId>	35x	Message Identification Mandatory	Message Identification Validation: [1..1]
</MsgHdr>		End of Message Header Mandatory	Validation: [1..1]
<Rltd>		Related Mandatory	References a previously received message. Validation: [1..1]
<Ref>-</Ref>	35x	Reference Mandatory	Unique and unambiguous reference Validation: [1..1]
</Rltd>		End of Related Mandatory	End of Related Validation: [1..1]
<PrtryData>		Proprietary Data Mandatory	Proprietary Data Validation: [1..1]
<Tp>-</Tp>		Proprietary Data type Mandatory	Proprietary Data type Validation: [1..1]
<Data>		Proprietary Data Mandatory	Proprietary data content Validation: [1..1]
<SspPrtryDt>		SSP Proprietary Data Mandatory	SSP Proprietary Data Validation: [1..1]
<ReturnStandingOrderMirror>		Message type for static data Mandatory	Validation: [1..1]
xorBizRptOpriErr		choice	choice amongst BizRpt und OpriErr Rule description: If BusinessReport is present then OperationalError is not allowed. If BusinessReport is not present, then OperationalError is mandatory.

name of attribute	format	short description	description
		Mandatory	Validation:
<BizRpt>		BusinessReport	BusinessReport Rule rationale: The message will contain either the information matching the search criteria of the related Get message or an error indication. Rule description: If BusinessReport is present then OperationalError is not allowed. If BusinessReport is not present, then OperationalError is mandatory.
		Mandatory	Validation: [1..1]
<StgOrdrlid>		Identification of the standing order	
		Mandatory	Validation: [1..1]
<Ptcptld>		Participant Identification	Participant Identification
		Mandatory	Validation: [1..1]
<BIC>-</BIC>	11x	BIC	BIC of settlement bank
		Mandatory	Validation: [1..1]
<PtcptNm>-</PtcptNm>	105x	Name of settlement bank first	
		Mandatory	Validation: [1..1]
</Ptcptld>		End of Participant Identification	End of Participant Identification
		Mandatory	Validation: [1..1]
<Acctld>		Account Identification	Account Identification
		Mandatory	Validation: [1..1]
<DmstAcct>		Simple Identification Information	Simple Identification Information Domestic Account Account number used by financial institutions in individual countries to identify an account of a customer, but necessarily the bank and branch of the financial institution in which the account is held.
		Mandatory	Validation: [1..1]
<ld>-</ld>	34x	Identification	Name or number assigned by an entity to enable recognition of that entity, eg, account identifier. Account number of the settlement bank
		Mandatory	Validation: [1..1]
</DmstAcct>		End of simple Identification Information	
		Mandatory	Validation: [1..1]

name of attribute	format	short description	description
</AcctId>		End of Account Identification Mandatory	End of Account Identification Validation: [1..1]
</StgOrdrlId>		End of Standing order Id Mandatory	End Standing order Id Validation: [1..1]
<StgOrdrValSet>		List of the standing orders Optional	Validation: [0..n]
<StgMirrorId>-</StgMirrorId>	18x	Identification of the standing order Mandatory	Identification of the standing order. This Id will be used to modify an existing standing Order. Currently this should be the id of the standing order. Validation: [1..1]
<Amt>		Amount Mandatory A2A	Validation: [1..1]
<AmtWthtCcy>-</AmtWthtCcy>	18n	Amount without currency Mandatory A2A	Validation: [1..1]
</Amt>		End of Amount Mandatory A2A	Validation: [1..1]
<Dbtr>		Debtor Optional	Information about the debtor of a payment. Validation: [0..1]
<FI>		Financial institution Mandatory	Financial institution Validation: [1..1]
<BIC>-</BIC>	11x	BIC Mandatory	BICIdentifier Code allocated to financial institutions by the Registration Authority, under an international identification scheme, as described in the latest version of the standard ISO 9362 "Banking - Banking telecommunication messages - Bank Identifier Codes". SWIFT is the Registration Authority for ISO 9362. BIC 52 of the standing order Validation: [1..1]
</FI>		End of financial institution Mandatory	End of financial institution Validation: [1..1]
</Dbtr>		End of debtor Optional	Validation:

name of attribute	format	short description	description
			[0..1]
<Cdtr>		Creditor Optional	Validation: [0..1]
<FI>		Financial institution Mandatory	Financial institution Validation: [1..1]
<BIC>-</BIC>	11x	BIC Mandatory	BICIdentifier Code allocated to financial institutions by the Registration Authority, under an international identification scheme, as described in the latest version of the standard ISO 9362 "Banking - Banking telecommunication messages - Bank Identifier Codes". SWIFT is the Registration Authority for ISO 9362. BIC 58 of the standing order Validation: [1..1]
</FI>		End of financial institution Mandatory	End of financial institution Validation: [1..1]
</Cdtr>		End of Creditor Optional	Validation: [0..1]
<CdtrAcct>		CreditorAccount Optional	Validation: [0..1]
<DmstAcct>		Simple Identification Information Mandatory	Simple Identification Information Validation: [1..1]
<Id>-</Id>	34x	Identification Mandatory	Name or number assigned by an entity to enable recognition of that entity, eg, account identifier. Account number for field 58 of the SO Validation: [1..1]
</DmstAcct>		End of simple Identification Information Mandatory	Validation: [1..1]
</CdtrAcct>		EndCreditorAccount Optional	Validation: [0..1]
<FnIAgt>		Final Agent Mandatory	Provides details about a system and about a member of a system BIC of Technical account - procedure 6 real-time Validation: [1..1]
<BIC>-</BIC>	11x	BIC	BICIdentifier

name of attribute	format	short description	description
			Code allocated to financial institutions by the Registration Authority, under an international identification scheme, as described in the latest version of the standard ISO 9362 "Banking - Banking telecommunication messages - Bank Identifier Codes". SWIFT is the Registration Authority for ISO 9362.
		Mandatory	Validation: [1..1]
</FnlAgt>		End of Final Agent	End of Final Agent
		Mandatory	Validation: [1..1]
<RmtInf>		RemittanceInformation	
		Optional	Validation: [0..1]
<Ustrd></Ustrd>	140x	Unstructured	Field 72 of the standing order
		Mandatory	Validation: [1..1] Not checked
</RmtInf>		EndRemittanceInformation	
		Optional	Validation: [0..1]
<Frqcy></Frqcy>	4x	Frequency	
		Mandatory	Validation: [1..1] Frequency of SO. In the case of SO Technical account - procedure 6 real-time the value is always OVNG.
</StgOrdrValSet>		List of the standing orders (End)	
		Optional	Validation: [0..n]
</BizRpt>		End of BusinessReport	
		Mandatory	Validation: [1..1]
<OpriErr>		OperationalError	Indicates an operational error
			Rule description: If BusinessReport is present then OperationalError is not allowed. If BusinessReport is not present, then OperationalError is mandatory.
		Mandatory	Validation: [1..1]
<Err>		Error handling	
		Mandatory	Validation: [1..1]
<Prtry></Prtry>	4x	Proprietary error code	Specification of the error, in free format.
		Mandatory	Validation: [1..1]
</Err>		End error handling	

name of attribute	format	short description	description
		Mandatory	Validation: [1..1]
<Desc></Desc>	140x	Description	Specification of the error, in free format.
		Optional	Validation: [0..1]
</OpriErr>		End of Operational Error	End of Operational Error
		Mandatory	Validation: [1..1]
/xorBizRptOpriErr		End of choice	
		Mandatory	Validation: [1..1]
</ReturnStandingOrderMirror>		message type for static data (end)	
		Mandatory	Validation: [1..1]
</SspPrtryDt>		End of SSP Proprietary Data	End of SSP Proprietary Data
		Mandatory	Validation: [1..1]
</Data>		End of Proprietary Data	
		Mandatory	Validation: [1..1]
</PrtryData>		End of Proprietary Data	End of Proprietary Data
		Mandatory	Validation: [1..1]
</PrtryMsg>		End proprietary message	
		Mandatory	Validation: [1..1]

Error Codes:

ReturnStandingOrderMirror_SD_1

Scope: This message is used to return the requested standing orders via GetStandingOrderMirror

Name Proprietary message	<PrtryMsg>
Message Header	<MsgHdr>
Message Identification	<MsgId>ABC123</MsgId>
End of Message Header	</MsgHdr>
Related	<Rltd>
Reference	<Ref>ABC012</Ref>
End of Related	</Rltd>
Proprietary Data	<PrtryData>
Proprietary Data type	<Tp>ReturnStandingOrderMirror</Tp>
Proprietary Data	<Data>
SSP Proprietary Data	<SspPrtryDt>
Message type for static data	<ReturnStandingOrderMirror>
BusinessReport	<BizRpt>
Identification of the standing order	<StgOrdrlId>
Participant Identification	<PtcptId>
BIC	<BIC>SETTBANKBIC</BIC>
Name of settlement bank first	<PtcptNm>SETTLEMENTBANKNAME</PtcptNm>
End of Participant Identification	</PtcptId>
Account Identification	<AcctId>
Simple Identification Information	<DmstAcct>
Identification	<Id>SETTLEMENTBANKACCOUNT</Id>
End of simple Identification Information	</DmstAcct>
End of Account Identification	</AcctId>
End of Standing order Id	</StgOrdrlId>
List of the standing orders	<StgOrdValSet>
Identification of the standing order	StgMirrorId>123456789012345678</StgMirrorId>
Amount	<Amt>
Amount without currency	<AmtWthtCcy>500000.00</AmtWthtCcy>
End of Amount	</Amt>
Debtor	<Dbtr>
Financial institution	<FI>
BIC	<BIC>FIELDIBC52X</BIC>
End of financial institution	</FI>
End of debtor	</Dbtr>
Creditor	<Cdtr>
Financial institution	<FI>
BIC	<BIC>FIELDIBC58X</BIC>
End of financial institution	</FI>
End of Creditor	</Cdtr>
CreditorAccount	<CdtrAcct>
Simple Identification Information	<DmstAcct>
Identification	<Id>FIELD58ACCOUNT</Id>
End of simple Identification Information	</DmstAcct>
EndCreditorAccount	</CdtrAcct>
Final Agent	<FnlAgt>
BIC	<BIC>MIRRORBICXX</BIC>
End of Final Agent	</FnlAgt>
RemittanceInformation	<RmtInf>
Unstructured	<Ustrd>FIELD72</Ustrd>

EndRemittanceInformation		</RmtInf>
Frequency		<Frqcy>OVNG</Frqcy>
List of the standing orders (End)		</StgOrdrValSet>
End of BusinessReport		</BizRpt>
message type for static data (end)		</ReturnStandingOrderMirror>
End of SSP Proprietary Data		</SspPrtryDt>
End of Proprietary Data		</Data>
End of Proprietary Data		</PrtryData>
End proprietary message		</PrtryMsg>

ReturnStandingOrderMirror_SD_2

Scope: Error message Response to an XML GetStandingOrderMirror request with an incorrect BIC

Name Proprietary message	<PrtryMsg>
Message Header	<MsgHdr>
Message Identification	<MsgId>8a8c818a3c5e9813013c62f4fe640093</MsgId>
End of Message Header	</MsgHdr>
Related	<Rltd>
Reference	<Ref>GetSOMirrorZYAJFRT0HS1</Ref>
End of Related	</Rltd>
Proprietary Data	<PrtryData>
Proprietary Data type	<Tp>ReturnStandingOrderMirror</Tp>
Proprietary Data	<Data>
SSP Proprietary Data	<SspPrtryDt>
Message type for static data	<ReturnStandingOrderMirror>
OperationalError	<OprlErr>
Error handling	<Err>
Proprietary error code	<Prtry>1199</Prtry>
End error handling	</Err>
Description	<Desc>Error validating payload document: line: 13 column: 40 reason: the value does not match</Desc>
End of Operational Error	</OprlErr>
message type for static data (end)	</ReturnStandingOrderMirror>
End of SSP Proprietary Data	</SspPrtryDt>
End of Proprietary Data	</Data>
End of Proprietary Data	</PrtryData>
End proprietary message	</PrtryMsg>

6. 5.47 ReturnStandingOrderSub

SSP Proprietary Messages

ReturnStandingOrderSub_SD

Scope: This message is used to return the requested standing orders via GetStandingOrderSub

<camt.998.001.xx>

Structure:

Message Type	<PrtryMsg>
Message Header	<MsgHdr>
Message Identification	<MsgId></MsgId>
End of Message Header	</MsgHdr>
Related	<Rltd>
Reference	<Ref></Ref>
End of Related	</Rltd>
Proprietary Data	<PrtryData>
Proprietary Data type	<Tp>ReturnStandingOrderSub</Tp>
Proprietary Data	<Data>
SSP Proprietary Data	<SspPrtryDt>
Message type for static data	<ReturnStandingOrderSub>
Choice amongst	xorBizRptOprlErr
BusinessReport	<BizRpt>
Identification of the Standing Order Sender	<StgOrdrlId>
Participant Identification	<PtcptId>
BIC	<BIC></BIC>
Name of settlement bank first	<PtcptNm></PtcptNm>
End of Participant Id	</PtcptId>
Account Identification	<AcctId>
Simple Identification Information	<DmstAcct>
Identification	<Id></Id>
End of simple Identification Information	</DmstAcct>
End of Account Identification	</AcctId>
End of Standing order Id	</StgOrdrlId>
List of the standing orders	<StgOrdrlValSet>
Amount	<Amt>
Amount without currency	<AmtWthtCcy></AmtWthtCcy>
End of Amount	</Amt>
CreditorAccount	<CdtrAcct>
Simple Identification Information	<DmstAcct>
Identification	<Id></Id>
End of simple Identification Information	</DmstAcct>
EndCreditorAccount	</CdtrAcct>
Frequency	<Frqcy></Frqcy>
List of the standing orders (End)	</StgOrdrlValSet>
End of BusinessReport	</BizRpt>
OperationalError	<OprlErr>
Error handling	<Err>
Proprietary error code	<Prtry></Prtry>
End error handling	</Err>
Description	<Desc></Desc>
End of Operational Error	</OprlErr>
End of choice	/xorBizRptOprlErr

End Message type for static data
End of SSP Proprietary Data
End of Proprietary Data
End of Proprietary Data
End proprietary message

```
| | | | </ReturnStandingOrderSub>  
| | | </SspPrtryDt>  
| | </Data>  
| </PrtryData>  
</PrtryMsg>
```

Attributes:

name of attribute	format	short description	description
<PrtryMsg>		Message Type Mandatory	Validation: [1..1]
<MsgHdr>		Message Header Mandatory	Set of characteristics specific to the message Validation: [1..1]
<MsgId></MsgId>	35x	Message Identification Mandatory	Message Identification Validation: [1..1]
</MsgHdr>		End of Message Header Mandatory	Validation: [1..1]
<Rltd>		Related Mandatory	References a previously received message. Validation: [1..1]
<Ref></Ref>	35x	Reference Mandatory	Unique and unambiguous reference Message Reference of the related request Validation: [1..1]
</Rltd>		End of Related Mandatory	End of Related Validation: [1..1]
<PrtryData>		Proprietary Data Mandatory	Proprietary Data Container of the free format XML Validation: [1..1]
<Tp></Tp>		Proprietary Data type Mandatory	Proprietary Data type Defines the Type of the free format XML. Here the value is "ReturnStandingOrderSub". Validation: [1..1]
<Data>		Proprietary Data Mandatory	Proprietary data content Validation: [1..1]
<SspPrtryDt>		SSP Proprietary Data Mandatory	Root element for all SSP proprietary data Validation: [1..1]
<ReturnStandingOrderSub>		Message type for static data Mandatory	Validation: [1..1]
xorBizRptOprlErr		Choice amongst Mandatory	Choice amongst xorBizRptOprlErr (Type: xor) Validation:

name of attribute	format	short description	description
			[1..1]
<BizRpt>		BusinessReport Mandatory	BusinessReport Validation: [1..1]
<StgOrdrlid>		Identification of the Standing Order Sender Mandatory	Validation: [1..1]
<Ptcptld>		Participant Identification Mandatory	Participant Identification Validation: [1..1]
<BIC>-</BIC>	11x	BIC Mandatory	BIC of the settlement bank Validation: [1..1]
<PtcptNm>-</PtcptNm>	105x	Name of settlement bank first Mandatory	Validation: [1..1]
</Ptcptld>		End of Participant Id Mandatory	End of Participant Id Validation: [1..1]
<Acctld>		Account Identification Mandatory	Account Identification Account Identification of the settlement bank Validation: [1..1]
<DmstAcct>		Simple Identification Information Mandatory	Simple Identification Information Domestic Account Account number used by financial institutions in individual countries to identify an account of a customer, but necessarily the bank and branch of the financial institution in which the account is held. Validation: [1..1]
<ld>-</ld>	34x	Identification Mandatory	Name or number assigned by an entity to enable recognition of that entity, eg, account identifier. Account number of settlement bank's RTGS main account (debit account) Validation: [1..1]
</DmstAcct>		End of simple Identification Information Mandatory	Validation: [1..1]
</Acctld>		End of Account Identification Mandatory	Unique and unambiguous identification for the account between the account owner and the account servicer. Validation: [1..1]

name of attribute	format	short description	description
<StgOrdrlId>		End of Standing order Id	End Standing order Id
		Mandatory	Validation: [1..1]
<StgOrdValSet>		List of the standing orders	
		Optional	Validation: [0..1]
<Amt>		Amount	
		Mandatory	Validation: [1..1]
<AmtWthtCcy>- </AmtWthtCcy>	18n	Amount without currency	Number of monetary units specified in a currency where the unit of currency is implied by the context. totalDigits = 18 fractionDigits = 5 Only 2 fraction digits are reported by SSP.
		Mandatory	Validation: [1..1]
</Amt>		End of Amount	End of Amount
		Mandatory	Validation: [1..1]
<CdtrAcct>		CreditorAccount	
		Mandatory	Validation: [1..1]
<DmstAcct>		Simple Identification Information	Simple Identification Information Domestic Account Account number used by financial institutions in individual countries to identify an account of a customer, but necessarily the bank and branch of the financial institution in which the account is held.
		Mandatory	Validation: [1..1]
<Id>-</Id>	34x	Identification	Name or number assigned by an entity to enable recognition of that entity, eg, account identifier. Identification number of sub account to be credited.
		Mandatory	Validation: [1..1]
</DmstAcct>		End of simple Identification Information	
		Mandatory	Validation: [1..1]
</CdtrAcct>		EndCreditorAccount	
		Mandatory	Validation: [1..1]
<Frqcy>-</Frqcy>	4x	Frequency	Possible Values are: DAIL = Daily Event takes place every day. OVNG = Overnight

name of attribute	format	short description	description
		Mandatory	Event takes place overnight Validation: [1..1]
</StgOrdrValSet>		List of the standing orders (End) Optional	Validation: [0..1]
</BizRpt>		End of BusinessReport Mandatory	End of BusinessReport Validation: [1..1]
<OprlErr>		OperationalError Mandatory	Rule rationale: The message will contain either the information matching the search criteria of the related Get message or an error indication. Rule description: If BusinessReport is present then OperationalError is not allowed. If BusinessReport is not present, then OperationalError is mandatory. Separate Specification see UDFS books regarding error codes Validation: [1..1]
<Err>		Error handling Mandatory	Validation: [1..1]
<Prtry>-</Prtry>	4x	Proprietary error code Mandatory	Specification of the error, in free format. Validation: [1..1]
</Err>		End error handling Mandatory	Validation: [1..1]
<Desc>-</Desc>	140x	Description Optional	Validation: [0..1]
</OprlErr>		End of Operational Error Mandatory	End of Operational Error Validation: [1..1]
/xorBizRptOprlErr		End of choice Mandatory	Validation: [1..1]
</ReturnStandingOrderSub>		End Message type for static data Mandatory	Validation: [1..1]
</SspPrtryDt>		End of SSP Proprietary Data Mandatory	End of SSP Proprietary Data Validation: [1..1]
</Data>		End of Proprietary Data	

name of attribute	format	short description	description
		Mandatory	Validation: [1..1]
</PrtryData>		End of Proprietary Data Mandatory	End of Proprietary Data Validation: [1..1]
</PrtryMsg>		End proprietary message Mandatory	Validation: [1..1]

Error Codes:

ReturnStandingOrderSub_SD_1

Scope: This message is used to return the standing orders requested via GetStandingOrderSub.

Message Type	<PrtryMsg>
Message Header	<MsgHdr>
Message Identification	<MsgId>ABC123</MsgId>
End of Message Header	</MsgHdr>
Related	<Rltd>
Message Identification	<Ref>REQUESTFORSO</Ref>
End of Related	</Rltd>
Proprietary Data	<PrtryData>
Proprietary Data type	<Tp>ReturnStandingOrderSub</Tp>
Proprietary Data	<Data>
SSP Proprietary Data	<SspPrtryDt>
Message type for static data	<ReturnStandingOrderSub>
BusinessReport	<BizRpt>
Identification of the Standing Order Sender	<StgOrdrlId>
Participant Identification	<PtcptId>
BIC	<BIC>SETTBANKBIC</BIC>
Name of settlement bank first	<PtcptNm>SETTLEMENTBANKNAME</PtcptNm>
End of Participant Id	</PtcptId>
Account Identification	<AcctId>
Simple Identification Information	<DmstAcct>
Identification	<Id>SETTLEMENTBANKMAINACCOUNT</Id>
End of simple Identification Information	</DmstAcct>
End of Account Identification	</AcctId>
End of Standing order Id	</StgOrdrlId>
List of the standing orders	<StgOrdrlValSet>
Amount	<Amt>
Amount without currency	<AmtWthtCcy>500000.00</AmtWthtCcy>
End of Amount	</Amt>
CreditorAccount	<CdtrAcct>
Simple Identification Information	<DmstAcct>
Identification	<Id>SETTLEMENTBANKSUBACCOUNT</Id>
End of simple Identification Information	</DmstAcct>
EndCreditorAccount	</CdtrAcct>
Frequency	<Frqcy>DAIL</Frqcy>
List of the standing orders (End)	</StgOrdrlValSet>
End of BusinessReport	</BizRpt>
End Message type for static data	</ReturnStandingOrderSub>
End of SSP Proprietary Data	</SspPrtryDt>
End of Proprietary Data	</Data>
End of Proprietary Data	</PrtryData>
End proprietary message	</PrtryMsg>

ReturnStandingOrderSub_SD_2

Scope: Error message Response to an XML GetStandingOrderSub request

Message Type	<PrtryMsg>
Message Header	<MsgHdr>
Message Identification	<MsgId>RETURNABC123</MsgId>
End of Message Header	</MsgHdr>
Related	<Rltd>
Reference	<Ref>ABC123</Ref>
End of Related	</Rltd>
Proprietary Data	<PrtryData>
Proprietary Data type	<Tp>ReturnStandingOrderSub</Tp>
Proprietary Data	<Data>
SSP Proprietary Data	<SspPrtryDt>
Message type for static data	<ReturnStandingOrderSub>
OperationalError	<OprlErr>
Error handling	<Err>
Proprietary error code	<Prtry>S100</Prtry>
End error handling	</Err>
Description	<Desc>No data available for selected criteria - You are not authorized to access to this data</Desc>
End of Operational Error	</OprlErr>
End Message type for static data	</ReturnStandingOrderSub>
End of SSP Proprietary Data	</SspPrtryDt>
End of Proprietary Data	</Data>
End of Proprietary Data	</PrtryData>
End proprietary message	</PrtryMsg>

6. 5.48 ReturnStandingOrder

Cash Management Standard

ReturnStandingOrder_SD

M

Scope: This message is used to return the requested standing orders via GetStandingOrder

It is a standard XML message <camt.070.001.xx>.

Structure:

Message name for ReturnStandingOrder	<RtrStgOrdr>
Message Header	<MsgHdr>
Message Identification	<MsgId></MsgId>
Original Business Query	<OrgnlBizQry>
Message Identification	<MsgId></MsgId>
End of Original Business Query	</OrgnlBizQry>
End of Message Header	</MsgHdr>
StandingOrderOrErrorChoice	<RptOrErr>
Choice	xorRptOprlErr
Report	<Rpt>
Identification of the standing order	<StgOrdrId>
Account Identification	<Acct>
Identification	<Id>
GenericAccountIdentification	<Othr>
Identification	<Id></Id>
End of GenericAccountIdentification	</Othr>
End Identification	</Id>
End of Account	</Acct>
End of Standing order Id	</StgOrdrId>
StandingOrderOrErrorChoice	<StgOrdrOrErr>
StandingOrder	<StgOrdr>
Amount	<Amt>
Amount without currency	<AmtWthtCcy></AmtWthtCcy>
End of Amount	</Amt>
Credit or debit indicator	<CdtDbtInd></CdtDbtInd>
CreditorAccount	<CdtrAcct>
Identification	<Id>
GenericAccountIdentification	<Othr>
Identification	<Id></Id>
End of GenericAccountIdentification	</Othr>
End Identification	</Id>
EndCreditorAccount	</CdtrAcct>
End of Standing Order	</StgOrdr>
End of StandingOrderOrErrorChoice	<StgOrdrOrErr>
End of Report	</Rpt>
OperationalError	<OprlErr>
Error handling	<Err>
Proprietary error code	<Prtry></Prtry>
End error handling	</Err>
Description	<Desc></Desc>
End of Operational Error	</OprlErr>
End of choice	/xorRptOprlErr
End of StandingOrderOrErrorChoice	</RptOrErr>
End of Message name for ReturnStandingOrder	</RtrStgOrdr>

Attributes:

name of attribute	format	short description	description
<RtrStgOrdr>		Message name for ReturnStandingOrder Mandatory	Validation: [1..1]
<MsgHdr>		Message Header Mandatory	Set of characteristics specific to the message Validation: [1..1]
<MsgId>-</MsgId>	35x	Message Identification Mandatory	Message Identification Validation: [1..1]
<OrgnlBizQry>		Original Business Query Mandatory	Original Business Query, reference to the query Validation: [1..1]
<MsgId>-</MsgId>	35x	Message Identification Mandatory	Message Identification Validation: [1..1]
</OrgnlBizQry>		End of Original Business Query Mandatory	End of Original Business Query, reference to the query Validation: [1..1]
</MsgHdr>		End of Message Header Mandatory	Validation: [1..1]
<RptOrErr>		StandingOrderOrErrorChoice Mandatory	Validation: [1..1]
xorRptOrPrErr		Choice Optional	Validation:
<Rpt>		Report Optional	Validation: [1..n]
<StgOrdrId>		Identification of the standing order Mandatory	Validation: [1..1]
<Acct>		Account Identification Mandatory	Validation: [1..1]
<Id>		Identification Mandatory	Identification Validation: [1..1]

name of attribute	format	short description	description
<Othr>		GenericAccountIdentification Mandatory	GenericAccountIdentification Validation: [1..1]
<Id>-</Id>	34x	Identification Mandatory	Name or number assigned by an entity to enable recognition of that entity, eg, account identifier. Validation: [1..1]
</Othr>		End of GenericAccountIdentification Mandatory	End of GenericAccountIdentification Validation: [1..1]
</Id>		End Identification Mandatory	End Identification Validation: [1..1]
</Acct>		End of Account Mandatory	End of Account Validation: [1..1]
</StgOrdrlId>		End of Standing order Id Mandatory	Validation: [1..1]
<StgOrdrOrErr>		StandingOrderOrErrorChoice Mandatory	Validation: [1..1]
<StgOrdr>		StandingOrder Mandatory	Instruction given by a party that has explicit authority to instruct a debit on the account, ie, either the debit account owner or originating party, to a first agent, to process cash transfers at specified intervals during an implicit or explicit period of time. A standing order is given once and is valid for an open or closed period of time. Validation: [1..1]
<Amt>		Amount Mandatory	Validation: [1..1]
<AmtWthtCcy>-</AmtWthtCcy>	18n	Amount without currency Mandatory	Number of monetary units specified in a currency where the unit of currency is implied by the context. The integer part of Amount must contain at least one digit. The decimal separator is a dot '.'. It is not mandatory but included in the maximum length. The number of digits following the dot must not exceed the maximum number allowed for that specific currency as specified in ISO 4217. Validation: [1..1]
</Amt>		End of Amount Mandatory	Validation: [1..1]

name of attribute	format	short description	description
<CdtDbtInd>-</CdtDbtInd>	4!a	Credit or debit indicator Mandatory	Validation: [1..1]
<CdtrAcct>		CreditorAccount Mandatory	Validation: [1..1]
<Id>		Identification Mandatory	Validation: [1..1]
<Othr>		GenericAccountIdentificatio n Mandatory	GenericAccountIdentification Validation: [1..1]
<Id>-</Id>	34x	Identification Mandatory	Name or number assigned by an entity to enable recognition of that entity, eg, account identifier. Validation: [1..1]
</Othr>		End of GenericAccountIdentificatio n Mandatory	End of GenericAccountIdentification Validation: [1..1]
</Id>		End Identification Mandatory	Validation: [1..1]
</CdtrAcct>		EndCreditorAccount Mandatory	Validation: [1..1]
</StgOrdr>		End of Standing Order Mandatory	End of Standing Order Validation: [1..1]
</StgOrdrOrErr>		End of StandingOrderOrErrorChoic e Mandatory	Validation: [1..1]
</Rpt>		End of Report Mandatory	Validation: [1..n]
<OprlErr>		OperationalError Mandatory	Indicates an operational error Rule description: If BusinessReport is present then OperationalError is not allowed. If BusinessReport is not present, then OperationalError is mandatory. Validation: [1..1]
<Err>		Error handling Mandatory	Validation:

name of attribute	format	short description	description
			[1..1]
<Prtry>-</Prtry>	4x	Proprietary error code	Specification of the error, in free format.
		Mandatory	Validation: [1..1]
</Err>		End error handling	
		Mandatory	Validation: [1..1]
<Desc>-</Desc>	140x	Description	Specification of the error, in free format.
		Optional	Validation: [0..1]
</OpriErr>		End of Operational Error	End of Operational Error
		Mandatory	Validation: [1..1]
/xorRptOpriErr		End of choice	
		Optional	Validation:
</RptOrErr>		End of StandingOrderOrErrorChoice	
		Mandatory	Validation: [1..1]
</RtrStgOrdr>		End of Message name for ReturnStandingOrder	
		Mandatory	Validation: [1..1]

Error Codes:

Scope:

Message name for ReturnStandingOrder	<RtrStgOrdr>
Message Header	<MsgHdr>
Message Identification	<MsgId>123ABC</MsgId>
Original Business Query	<OrgnlBizQry>
Message Identification	<MsgId>ABC123</MsgId>
End of Original Business Query	</OrgnlBizQry>
End of Message Header	</MsgHdr>
StandingOrderOrErrorChoice	<RptOrErr>
Report	<Rpt>
Identification of the standing order	<StgOrdrId>
Account Identification	<Acct>
Identification	<Id>
GenericAccountIdentification	<Othr>
Identification	<Id>RTGSBE3456789122345678323456789123</Id>
End of GenericAccountIdentification	</Othr>
End Identification	</Id>
End of Account	</Acct>
End of Standing order Id	</StgOrdrId>
StandingOrderOrErrorChoice	<StgOrdrOrErr>
StandingOrder	<StgOrdr>
Amount	<Amt>
Amount without currency	<AmtWthtCcy>500000.00</AmtWthtCcy>
End of Amount	</Amt>
Credit or debit indicator	<CdtDbtInd>DBIT</CdtDbtInd>
CreditorAccount	<CdtrAcct>
Identification	<Id>
GenericAccountIdentification	<Othr>
Identification	<Id>DCABE23456789122345678323456789123</Id>
End of GenericAccountIdentification	</Othr>
End Identification	</Id>
EndCreditorAccount	</CdtrAcct>
End of Standing Order	</StgOrdr>
End of StandingOrderOrErrorChoice	</StgOrdrOrErr>
End of Report	</Rpt>
End of StandingOrderOrErrorChoice	</RptOrErr>
End of Message name for ReturnStandingOrder	</RtrStgOrdr>

Scope: Error message Response to an XML GetStandingOrderDCA request

Message name for ReturnStandingOrder	<RtrStgOrdr>
Message Header	<MsgHdr>
Message Identification	<MsgId>RETURNABC123</MsgId>
Original Business Query	<OrgnlBizQry>
Message Identification	<MsgId>ABC123</MsgId>
End of Original Business Query	</OrgnlBizQry>
End of Message Header	</MsgHdr>
StandingOrderOrErrorChoice	<RptOrErr>
OperationalError	<OprlErr>
Error handling	<Err>
Proprietary error code	<Prtry>1422</Prtry>
End error handling	</Err>
Description	<Desc>The DCA must be linked to an RTGS account related to the sender</Desc>
End of Operational Error	</OprlErr>
End of StandingOrderOrErrorChoice	</RptOrErr>
End of Message name for ReturnStandingOrder	</RtrStgOrdr>

Scope:

Message name for ReturnStandingOrder	<RtrStgOrdr>	A
Message Header	<MsgHdr>	A
Message Identification	<MsgId>ABC123</MsgId>	A
Original Business Query	<OrgnlBizQry>	A
Message Identification	<MsgId>123ABC</MsgId>	A
End of Original Business Query	</OrgnlBizQry>	A
End of Message Header	</MsgHdr>	A
StandingOrderOrErrorChoice	<RptOrErr>	A
Report	<Rpt>	A
Identification of the standing order	<StgOrdrId>	A
Account Identification	<Acct>	A
Identification	<Id>	A
GenericAccountIdentification	<Othr>	A
Identification	<Id>RTGSBE3456789122345678323456789123</Id>	A
End of GenericAccountIdentification	</Othr>	A
End Identification	</Id>	A
End of Account	</Acct>	A
End of Standing order Id	</StgOrdrId>	A
StandingOrderOrErrorChoice	<StgOrdrOrErr>	A
StandingOrder	<StgOrdr>	A
Amount	<Amt>	A
Amount without currency	<AmtWthtCcy>500000.00</AmtWthtCcy>	A
End of Amount	</Amt>	A
Credit or debit indicator	<CdtDbtInd>DBIT</CdtDbtInd>	A
CreditorAccount	<CdtrAcct>	A
Identification	<Id>	A
GenericAccountIdentification	<Othr>	A
Identification	<Id>TIPSBE1234567891223456789</Id>	A
End of GenericAccountIdentification	</Othr>	A
End Identification	</Id>	A
EndCreditorAccount	</CdtrAcct>	A
End of Standing Order	</StgOrdr>	A
End of StandingOrderOrErrorChoice	</StgOrdrOrErr>	A
End of Report	</Rpt>	A
End of StandingOrderOrErrorChoice	</RptOrErr>	A
End of Message name for ReturnStandingOrder	</RtrStgOrdr>	A

6. 5.49 ReturnSubAccount

SSP Proprietary Messages

ReturnSubAccount_SD

Scope: This is the response to the XML Request : GetSubAccount

<camt.998.001.xx>

Structure:

Name Proprietary message	<PrtryMsg>
Message Header	<MsgHdr>
Message Identification	<MsgId></MsgId>
End of Message Header	</MsgHdr>
Related	<Rltd>
Reference	<Ref></Ref>
End of Related	</Rltd>
Proprietary Data	<PrtryData>
Proprietary Data type	<Tp>ReturnSubAccount</Tp>
Proprietary Data	<Data>
SSP Proprietary Data	<SspPrtryDt>
Message Type	<ReturnSubAccount>
Choice amongst	<xorBizRptOprlErr>
BusinessReport	<BizRpt>
Sub Account	<SubAcct>
Participant Information	<PtcptInf>
Participant Name1	<PtcptNm1></PtcptNm1>
BIC	<BIC></BIC>
BIC Addressee	<BICAddss></BICAddss>
National Sorting Code	<NSC></NSC>
End of Participant Information	</PtcptInf>
Record Status Information	<RecStsInf>
Planned Change	<PlnndChng></PlnndChng>
Record Status	<RecSts></RecSts>
First Activation Date	<FrstDt></FrstDt>
Modification Date	<ModDt></ModDt>
End Date	<EndDt></EndDt>
End of Record Status Information	</RecStsInf>
Account Information	<AcctInf>
Sub Account Name	<SubAcctNm></SubAcctNm>
Sub Account Number	<SubAcctNb></SubAcctNb>
Dedicated AS	<DdctdAS></DdctdAS>
End of Account Information	</AcctInf>
End of Sub Account	</SubAcct>
End of BusinessReport	</BizRpt>
OperationalError	<OprlErr>
Error handling	<Err>
Proprietary error code	<Prtry></Prtry>
End error handling	</Err>
Description	<Desc></Desc>
End of Operational Error	</OprlErr>
End of choice	</xorBizRptOprlErr>
End of Message Type	</ReturnSubAccount>
End of SSP Proprietary Data	</SspPrtryDt>

End of Proprietary Data
End of Proprietary Data
End proprietary message

```
| | </Data>  
| | </PrtryData>  
| </PrtryMsg>
```

Attributes:

name of attribute	format	short description	description
<PrtryMsg>		Name Proprietary message Mandatory	Validation:
<MsgHdr>		Message Header Mandatory	Set of characteristics specific to the message Validation: [1..1]
<MsgId></MsgId>	35x	Message Identification Mandatory	Message Identification Validation: [1..1]
</MsgHdr>		End of Message Header Mandatory	Validation: [1..1]
<Rltd>		Related Optional	References a previously received message. Validation:
<Ref></Ref>	35x	Reference Mandatory	Unique and unambiguous reference Validation: [1..1]
</Rltd>		End of Related Optional	End of Related Validation:
<PrtryData>		Proprietary Data Mandatory	Proprietary Data Validation: [1..1]
<Tp></Tp>	35x	Proprietary Data type Mandatory	Proprietary Data type defines the Type of the free format XML Validation: [1..1]
<Data>		Proprietary Data Mandatory	Proprietary data content Validation: [1..1]
<SspPrtryDt>		SSP Proprietary Data Mandatory	Root element for all SSP proprietary data Validation: [1..1]
<ReturnSubAccount>		Message Type Mandatory	Message Type for Static Data Validation: [1..1]
xorBizRptOprlErr		Choice amongst Optional	Choice amongst xorBizRptOprlErr (Type: xor) Validation:

name of attribute	format	short description	description
<BizRpt>		BusinessReport	BusinessReport Rule rationale: The message will contain either the information matching the search criteria of the related Get message or an error indication. Rule description: If BusinessReport is present then OperationalError is not allowed. If BusinessReport is not present, then OperationalError is mandatory.
		Mandatory	Validation: [1..1]
<SubAcct>		Sub Account	Sub Account
		Mandatory	Validation: [1..n]
<PtcptInf>		Participant Information	Participant Information
		Mandatory	Validation: [1..1]
<PtcptNm1>-</PtcptNm1>	35x	Participant Name1	Participant Name, first line.
		Mandatory	Validation: [1..1]
<BIC>-</BIC>	4!a2!a2!c3!c	BIC	A code allocated to a financial institution by a Registration Authority under an international identification scheme, as described in the latest edition of the international standard ISO 9362 "Banking - Banking telecommunication messages - Bank identifier codes". BIC 11 of the Sub Account Holder (BIC Participant of the related RTGS Account).
		Mandatory	Validation: [1..1]
<BICAddss>-</BICAddss>	4!a2!a2!c3!c]	BIC Addressee	A code allocated to a financial institution by a Registration Authority under an international identification scheme, as described in the latest edition of the international standard ISO 9362 "Banking - Banking telecommunication messages - Bank identifier codes". In this case, this is the Addressee BIC (BIC 11).
		Mandatory	Validation: [1..1]
<NSC>-</NSC>	15n	National Sorting Code	Code present in the BIC DATA +. Character string with a max length of 15 characters.
		Optional	Validation: [1..1]
</PtcptInf>		End of Participant Information	End of Participant Information
		Mandatory	Validation: [1..1]
<RecStsInf>		Record Status Information	Record Status Information
		Mandatory	Validation: [1..1]
<PlnndChng>-</PlnndChng>	1!a	Planned Change	Information on record regarding the presence of a future record. Values may be :

name of attribute	format	short description	description
			<p>"N" if no future record is present "D" if the record will be deleted "M" if a future record exists</p> <p>Note : the Planned Change flag has been added in order to help users when displaying an active record. Actually, for an active record with an End Date different from '9999-12-31', it is not possible to know whether the related record will be deleted (when the system reach the End Date) or if a future record exists and will be active, as a substitute for the active one.</p> <p>The use of the Planned Change flag is made to have information on the future of an active record.</p>
		Mandatory	<p>Validation: [1..1]</p>
<RecSts>--</RecSts>	2x	Record Status	<p>Status of the record. List of values :</p> <p>"AC" for Active "FU" for Future "RE" for Rejected "AR" for Archived "AF" for Archived Future "IC" for In Change "DV" for Delivery (Technical) "ID" for In Deletion (Technical)</p> <p>For more information on status management, refer to the ICM UserHandBook.</p>
		Mandatory	<p>Validation: [1..1]</p>
<FrstDt>--</FrstDt>	ISODate	First Activation Date	<p>Date within a particular calendar year represented by YYYY-MM-DD (ISO 8601). This date represents the first activation date of a functional item, such as a Participant. It is different from the modification date, which is the last date when a modification occurred.</p>
		Mandatory	<p>Validation: [1..1]</p>
<ModDt>--</ModDt>	ISODate	Modification Date	<p>Date within a particular calendar year represented by YYYY-MM-DD (ISO 8601).</p> <p>This is the modification date of the related record. If the record has not been modified since its activation, the modification date is equal to the first activation date.</p>
		Mandatory	<p>Validation: [1..1]</p>
<EndDt>--</EndDt>	ISODate	End Date	<p>Date within a particular calendar year represented by YYYY-MM-DD (ISO 8601).</p> <p>This is the end date of the related record. Value is equal to '9999-12-31' if no modification or deletion are foreseen for this record. Otherwise, the End Date takes the value of the modification date or date of the deletion.</p>
		Mandatory	<p>Validation: [1..1]</p>
</RecStsInf>		End of Record Status Information	<p>End of Record Status Information</p>
		Mandatory	<p>Validation: [1..1]</p>

name of attribute	format	short description	description
<AcctInf>		Account Information	Account Information
		Mandatory	Validation: [1..1]
<SubAcctNm>-</SubAcctNm>	35x	Sub Account Name	Sub Account Name
		Mandatory	Validation: [1..1]
<SubAcctNb>-</SubAcctNb>	2!c32x	Sub Account Number	Account Code. Length 34 characters. The first two characters represent the country code of the responsible CB.
		Mandatory	Validation: [1..1]
<DdctdAS>-</DdctdAS>	35x	Dedicated AS	Name of the AS dedicated to the Sub Account.
		Optional	Validation: [0..1]
</AcctInf>		End of Account Information	End of Account Information
		Mandatory	Validation: [1..1]
</SubAcct>		End of Sub Account	End of Sub Account
		Mandatory	Validation: [1..n]
</BizRpt>		End of BusinessReport	End of BusinessReport
		Mandatory	Validation: [1..1]
<OpriErr>		OperationalError	Rule rationale: The message will contain either the information matching the search criteria of the related Get message or an error indication. Rule description: If BusinessReport is present then OperationalError is not allowed. If BusinessReport is not present, then OperationalError is mandatory. Separate Specification see UDFS books regarding error codes
		Mandatory	Validation: [1..1]
<Err>		Error handling	
		Mandatory	Validation: [1..1]
<Prtry>-</Prtry>	4x	Proprietary error code	Specification of the error, in free format.
		Mandatory	Validation: [1..1]
</Err>		End error handling	
		Mandatory	Validation: [1..1]
<Desc>-</Desc>	140x	Description	Specification of the error, in free format.
		Optional	Validation:

name of attribute	format	short description	description
</OprlErr>		End of Operational Error	End of Operational Error
		Mandatory	Validation: [1..1]
/xorBizRptOprlErr		End of choice	End of Choice
		Optional	Validation:
</ReturnSubAccount>		End of Message Type	End of Message Type for Static Data
		Mandatory	Validation: [1..1]
</SspPrtryDt>		End of SSP Proprietary Data	End of Root element for all SSP proprietary data
		Mandatory	Validation: [1..1]
</Data>		End of Proprietary Data	
		Mandatory	Validation: [1..1]
</PrtryData>		End of Proprietary Data	End of Proprietary Data
		Mandatory	Validation: [1..1]
</PrtryMsg>		End proprietary message	
		Mandatory	Validation:

Error Codes:

ReturnSubAccount_SD_1

Scope: Response to the XML GetSubAccount Request

Name Proprietary message	<PrtryMsg>
Message Header	<MsgHdr>
Message Identification	<Msgld>13588716441061197422512</Msgld>
End of Message Header	</MsgHdr>
Related	<Rltd>
Reference	<Ref>GetSubAcctZYAJFRT0BS1</Ref>
End of Related	</Rltd>
Proprietary Data	<PrtryData>
Proprietary Data type	<Tp>ReturnSubAccount</Tp>
Proprietary Data	<Data>
SSP Proprietary Data	<SspPrtryDt>
Message Type	<ReturnSubAccount>
BusinessReport	<BizRpt>
Sub Account	<SubAcct>
Participant Information	<PtcptInf>
Participant Name1	<PtcptNm1>12345678901234567890123456789012345 </PtcptNm1>
BIC	<BIC>ZYAJFRT0BS1</BIC>
BIC Addressee	<BICAddss>ZYAJFRT0BS1</BICAddss>
End of Participant Information	</PtcptInf>
Record Status Information	<RecStsInf>
Planned Change	<PlnndChng>N</PlnndChng>
Record Status	<RecSts>AC</RecSts>
First Activation Date	<FrstDt>2008-06-12</FrstDt>
Modification Date	<ModDt>2008-06-12</ModDt>
End Date	<EndDt>9999-12-31</EndDt>
End of Record Status Information	</RecStsInf>
Account Information	<AcctInf>
Sub Account Name	<SubAcctNm>SUB 01 ZYAJFRT0BS1</SubAcctNm>
Sub Account Number	<SubAcctNb>BESACCYAJFRT0BS100000000000003 0002</SubAcctNb>
Dedicated AS	<DdctdAS>ZYAJFRT0BAA</DdctdAS>
End of Account Information	</AcctInf>
End of Sub Account	</SubAcct>
End of BusinessReport	</BizRpt>
End of Message Type	</ReturnSubAccount>
End of SSP Proprietary Data	</SspPrtryDt>
End of Proprietary Data	</Data>
End of Proprietary Data	</PrtryData>
End proprietary message	</PrtryMsg>

ReturnSubAccount_SD_2

Scope: Error message Response to the XML GetSubAccount with a Future status request

Name Proprietary message	<PrtryMsg>
Message Header	<MsgHdr>
Message Identification	<Msgld>13588717647411577472419</Msgld>
End of Message Header	</MsgHdr>
Related	<Rltd>
Reference	<Ref>GetSubAcct ZYAJFRT0BS1</Ref>
End of Related	</Rltd>
Proprietary Data	<PrtryData>
Proprietary Data type	<Tp>ReturnSubAccount</Tp>
Proprietary Data	<Data>
SSP Proprietary Data	<SspPrtryDt>
Message Type	<ReturnSubAccount>
OperationalError	<OprlErr>
Error handling	<Err>
Proprietary error code	<Prtry>S100</Prtry>
End error handling	</Err>
Description	<Desc>No data available for selected criteria-no sub account found for the specified input</Desc>
End of Operational Error	</OprlErr>
End of Message Type	</ReturnSubAccount>
End of SSP Proprietary Data	</SspPrtryDt>
End of Proprietary Data	</Data>
End of Proprietary Data	</PrtryData>
End proprietary message	</PrtryMsg>

6. 5.50 ReturnT2Wildcard

SSP Proprietary Messages

ReturnT2Wildcard_SD

Scope: This is the response to the XML request : GetT2Wildcard

<camt.998.001.xx>

Structure:

Name Proprietary message	<PrtryMsg>
Message Header	<MsgHdr>
Message Identification	<MsgId></MsgId>
End of Message Header	</MsgHdr>
Related	<Rltd>
Reference	<Ref></Ref>
End of Related	</Rltd>
Proprietary Data	<PrtryData>
Proprietary Data type	<Tp>ReturnT2Wildcard</Tp>
Proprietary Data	<Data>
SSP Proprietary Data	<SspPrtryDt>
Message Type	<ReturnT2Wildcard>
Choice amongst	<xorBizRptOprlErr>
BusinessReport	<BizRpt>
T2 WildCard	<Trgt2WCard>
Participant Information	<PtcptInf>
Participant Name1	<PtcptNm1></PtcptNm1>
BIC	<BIC></BIC>
BIC Addressee	<BICAddss></BICAddss>
National Sorting Code	<NSC></NSC>
End of Participant Information	</PtcptInf>
Record Status Information	<RecStsInf>
Planned Change	<PlnndChng></PlnndChng>
Record Status	<RecSts></RecSts>
First Activation Date	<FrstDt></FrstDt>
Modification Date	<ModDt></ModDt>
End Date	<EndDt></EndDt>
End of Record Status Information	</RecStsInf>
T2WildCard Information	<Trgt2WCardInf>
BIC of the T2 Directory Wildcard Rule	<BICID></BICID>
BIC Addressee	<BICAddss></BICAddss>
Branch Code	<BrnchFlag></BrnchFlag>
Type	<WCardTp></WCardTp>
Wildcard participation type	<WCardPtcpTp></WCardPtcpTp>
End of T2WildCard Information	</Trgt2WCardInf>
End of T2WildCard	</Trgt2WCard>
End of BusinessReport	</BizRpt>
OperationalError	<OprlErr>
Error handling	<Err>
Proprietary error code	<Prtry></Prtry>
End error handling	</Err>
Description	<Desc></Desc>
End of Operational Error	</OprlErr>
End of choice	</xorBizRptOprlErr>

End of Message Type					</ReturnT2Wildcard>
End of SSP Proprietary Data					</SspPrtryDt>
End of Proprietary Data					</Data>
End of Proprietary Data					</PrtryData>
End proprietary message					</PrtryMsg>

Attributes:

name of attribute	format	short description	description
<PrtryMsg>		Name Proprietary message Mandatory	Validation: [1..1]
<MsgHdr>		Message Header Mandatory	Set of characteristics specific to the message Validation: [1..1]
<MsgId>-</MsgId>	35x	Message Identification Mandatory	Message Identification Validation: [1..1]
</MsgHdr>		End of Message Header Mandatory	Validation: [1..1]
<Rltd>		Related Optional	References a previously received message. Validation: [0..1]
<Ref>-</Ref>	35x	Reference Mandatory	Unique and unambiguous reference Validation: [1..1]
</Rltd>		End of Related Optional	End of Related Validation: [0..1]
<PrtryData>		Proprietary Data Mandatory	Proprietary Data Validation: [1..1]
<Tp>-</Tp>	35x	Proprietary Data type Mandatory	Proprietary Data type defines the Type of the free format XML Validation: [1..1]
<Data>		Proprietary Data Mandatory	Proprietary data content Validation: [1..1]
<SspPrtryDt>		SSP Proprietary Data Mandatory	Root element for all SSP proprietary data Validation: [1..1]
<ReturnT2Wildcard>		Message Type Mandatory	Message Type for Static Data Validation: [1..1]
xorBizRptOpriErr		Choice amongst Optional	Choice amongst xorBizRptOpriErr (Type: xor) Validation:

name of attribute	format	short description	description
<BizRpt>		BusinessReport	BusinessReport Rule rationale: The message will contain either the information matching the search criteria of the related Get message or an error indication. Rule description: If BusinessReport is present then OperationalError is not allowed. If BusinessReport is not present, then OperationalError is mandatory.
		Mandatory	Validation: [1..1]
<Trgt2WCard>		T2 WildCard	T2 WildCard
		Mandatory	Validation: [1..n]
<PtcptInf>		Participant Information	Participant Information
		Mandatory	Validation: [1..1]
<PtcptNm1>-</PtcptNm1>	35x	Participant Name1	Participant Name, first line.
		Mandatory	Validation: [1..1]
<BIC>-</BIC>	4!a2!a2!c3!c	BIC	A code allocated to a financial institution by a Registration Authority under an international identification scheme, as described in the latest edition of the international standard ISO 9362 "Banking - Banking telecommunication messages - Bank identifier codes". BIC 11 of the T2 WildCard Holder (BIC Participant).
		Mandatory	Validation: [1..1]
<BICAddss>-</BICAddss>	4!a2!a2!c3!c]	BIC Addressee	A code allocated to a financial institution by a Registration Authority under an international identification scheme, as described in the latest edition of the international standard ISO 9362 "Banking - Banking telecommunication messages - Bank identifier codes". In this case, this is the Addressee BIC (BIC 11).
		Optional	Validation: [0..1]
<NSC>-</NSC>	15n	National Sorting Code	Code present in the BIC DATA +. Character string with a max length of 15 characters.
		Optional	Validation: [0..1]
</PtcptInf>		End of Participant Information	End of Participant Information
		Mandatory	Validation: [1..1]
<RecStsInf>		Record Status Information	Record Status Information
		Mandatory	Validation: [1..1]
<PlndChng>-</PlndChng>	1!a	Planned Change	Information on record regarding the presence of a future record. Values may be :

name of attribute	format	short description	description
			<p>"N" if no future record is present "D" if the record will be deleted "M" if a future record exists</p> <p>Note : the Planned Change flag has been added in order to help users when displaying an active record. Actually, for an active record with an End Date different from '9999-12-31', it is not possible to know whether the related record will be deleted (when the system reach the End Date) or if a future record exists and will be active, as a substitute for the active one.</p> <p>The use of the Planned Change flag is made to have information on the future of an active record.</p>
		Mandatory	<p>Validation: [1..1]</p>
<RecSts>--</RecSts>	2x	Record Status	<p>Status of the record. List of values :</p> <p>"AC" for Active "FU" for Future "RE" for Rejected "AR" for Archived "AF" for Archived Future "IC" for In Change "DV" for Delivery (Technical) "ID" for In Deletion (Technical)</p> <p>For more information on status management, refer to the ICM UserHandBook.</p>
		Mandatory	<p>Validation: [1..1]</p>
<FrstDt>--</FrstDt>	ISODate	First Activation Date	<p>Date within a particular calendar year represented by YYYY-MM-DD (ISO 8601). This date represents the first activation date of a functional item, such as a Participant. It is different from the modification date, which is the last date when a modification occurred.</p>
		Mandatory	<p>Validation: [1..1]</p>
<ModDt>--</ModDt>	ISODate	Modification Date	<p>Date within a particular calendar year represented by YYYY-MM-DD (ISO 8601).</p> <p>This is the modification date of the related record. If the record has not been modified since its activation, the modification date is equal to the first activation date.</p>
		Mandatory	<p>Validation: [1..1]</p>
<EndDt>--</EndDt>	ISODate	End Date	<p>Date within a particular calendar year represented by YYYY-MM-DD (ISO 8601).</p> <p>This is the end date of the related record. Value is equal to '9999-12-31' if no modification or deletion are foreseen for this record. Otherwise, the End Date takes the value of the modification date or date of the deletion.</p>
		Mandatory	<p>Validation: [1..1]</p>
</RecStsInf>		End of Record Status Information	<p>End of Record Status Information</p>
		Mandatory	<p>Validation: [1..1]</p>

name of attribute	format	short description	description
<Trgt2WCardInf>		T2WildCard Information	T2WildCard Information
		Optional	Validation: [0..n]
<BICID></BICID>	12x	BIC of the T2 Directory Wildcard Rule	BIC of the T2 Directory Wildcard Rule. This field includes a wildcard sign.
		Mandatory	Validation: [1..1]
<BICAddss></BICAddss>	4!a2!a2!c[3!c]	BIC Addressee	A code allocated to a financial institution by a Registration Authority under an international identification scheme, as described in the latest edition of the international standard ISO 9362 "Banking - Banking telecommunication messages - Bank identifier codes".
		Optional	In this case, this is the Addressee BIC (BIC 11). Validation:
<BrnchFlag></BrnchFlag>	1!a	Branch Code	A flag with two values : 'Y' or 'N'
		Mandatory	Validation: [1..1]
<WCardTp></WCardTp>	1!a	Type	Flag indicating whether the rule is included or excluded. Values may be :
		Mandatory	'I' for Inclusion 'E' for Exclusion 'A' for getting all type of Wildcard (used for 'Get' XML Message). Validation: [1..1]
<WCardPtcpTp></WCardPtcpTp>	2!n	Wildcard participation type	Participation type of wildcard
		Optional	'Addressable BIC branch' participation type will be returned with a '00' value whatever it concerns a direct or an indirect participant. It is due to the fact that when capturing a wildcard rule with an 'Addressable BIC branch' participation type, no distinction is made between direct or indirect participant. Validation: [0..1]
</Trgt2WCardInf>		End of T2WildCard Information	End of T2WildCard Information
		Optional	Validation: [0..n]
</Trgt2WCard>		End of T2WildCard	End of T2WildCard
		Mandatory	Validation: [1..n]
</BizRpt>		End of BusinessReport	End of BusinessReport
		Mandatory	Validation: [1..1]
<OprlErr>		OperationalError	Rule rationale: The message will contain either the information matching the search criteria of the related Get message or an error indication.
			Rule description: If BusinessReport is present then OperationalError is not allowed. If BusinessReport is not present, then OperationalError is mandatory.

name of attribute	format	short description	description
			Separate Specification see UDFS books regarding error codes
		Mandatory	Validation: [1..1]
<Err>		Error handling	
		Mandatory	Validation: [1..1]
<Prtry>-</Prtry>	4x	Proprietary error code	Specification of the error, in free format.
		Mandatory	Validation: [1..1]
</Err>		End error handling	
		Mandatory	Validation: [1..1]
<Desc>-</Desc>	140x	Description	Specification of the error, in free format.
		Optional	Validation: [0..1]
</OprlErr>		End of Operational Error	End of Operational Error
		Mandatory	Validation: [1..1]
/xorBizRptOprlErr		End of choice	End of Choice
		Optional	Validation:
</ReturnT2Wildcard>		End of Message Type	End of Message Type for Static Data
		Mandatory	Validation: [1..1]
</SspPrtryDt>		End of SSP Proprietary Data	End of SSP Proprietary Data
		Mandatory	Validation: [1..1]
</Data>		End of Proprietary Data	
		Mandatory	Validation: [1..1]
</PrtryData>		End of Proprietary Data	End of Proprietary Data
		Mandatory	Validation: [1..1]
</PrtryMsg>		End proprietary message	
		Mandatory	Validation:

Error Codes:

ReturnT2Wildcard_SD_1

Scope: Response to the XML GetT2Wildcard

Name Proprietary message	<PrtryMsg>
Message Header	<MsgHdr>
Message Identification	<MsgId>RETURNABC123</MsgId>
End of Message Header	</MsgHdr>
Related	<Rltd>
Reference	<Ref>ABC123</Ref>
End of Related	</Rltd>
Proprietary Data	<PrtryData>
Proprietary Data type	<Tp>ReturnT2Wildcard</Tp>
Proprietary Data	<Data>
SSP Proprietary Data	<SspPrtryDt>
Message Type	<ReturnT2Wildcard>
BusinessReport	<BizRpt>
T2 WildCard	<Trgt2WCard>
Participant Information	<PtcptInf>
Participant Name1	<PtcptNm1>SDMESCRM010</PtcptNm1>
BIC	<BIC>SDMESCRM010</BIC>
BIC Addressee	<BICAddss>SDMESCRM010</BICAddss>
End of Participant Information	</PtcptInf>
Record Status Information	<RecStsInf>
Planned Change	<PlnndChng>N</PlnndChng>
Record Status	<RecSts>AC</RecSts>
First Activation Date	<FrstDt>2012-11-26</FrstDt>
Modification Date	<ModDt>2012-11-26</ModDt>
End Date	<EndDt>9999-12-31</EndDt>
End of Record Status Information	</RecStsInf>
T2Wildcard Information	<Trgt2WCardInf>
BIC of the T2 Directory Wildcard Rule	<BICID>SDMESCRM05</BICID>
Branch Code	<BrnchFlag>N</BrnchFlag>
Type	<WCardTp>I</WCardTp>
Wildcard participation type	<WCardPtcpTp>00</WCardPtcpTp>
End of T2Wildcard Information	</Trgt2WCardInf>
End of T2Wildcard	</Trgt2WCard>
End of BusinessReport	</BizRpt>
End of Message Type	</ReturnT2Wildcard>
End of SSP Proprietary Data	</SspPrtryDt>
End of Proprietary Data	</Data>
End of Proprietary Data	</PrtryData>
End proprietary message	</PrtryMsg>

ReturnT2Wildcard_SD_2

Scope: Error message Response to an XML GetT2Wildcard request

Name Proprietary message	<PrtryMsg>
Message Header	<MsgHdr>
Message Identification	<MsgId>RETURNABC123</MsgId>
End of Message Header	</MsgHdr>
Related	<Rltd>
Reference	<Ref>ABC123</Ref>
End of Related	</Rltd>
Proprietary Data	<PrtryData>
Proprietary Data type	<Tp>ReturnT2Wildcard</Tp>
Proprietary Data	<Data>
SSP Proprietary Data	<SspPrtryDt>
Message Type	<ReturnT2Wildcard>
OperationalError	<OprlErr>
Error handling	<Err>
Proprietary error code	<Prtry>S100</Prtry>
End error handling	</Err>
Description	<Desc>General system error - No wildcard rules found</Desc>
End of Operational Error	</OprlErr>
End of Message Type	</ReturnT2Wildcard>
End of SSP Proprietary Data	</SspPrtryDt>
End of Proprietary Data	</Data>
End of Proprietary Data	</PrtryData>
End proprietary message	</PrtryMsg>

6. 6 XML messages related to ASI

6. 6. 1 ASInitiationStatus

SSP Proprietary Messages

ASInitiationStatus

Scope: The ASInitiationStatus is sent by the ASI to inform the sender of the ASTransferInitiation of the result (accepted or rejected) of the process of the transactions in the SSP.

This message could be used in the following cases :

- To reject the input file for error in the data
- To confirm a partial execution of the transactions (Model 3)
- To confirm the complete execution of the transactions or the reject of the file for failure or disagreement (Model 4 or Model 5)

<pain.998.001.xx>

Structure:

Message Type	<pain.998.001.01>
Proprietary Data	<PrtryDt>
Proprietary Data type	<Tp>ASInitiationStatus</Tp>
SSP Proprietary Data	<SspPrtryDt>
GeneralInformation	<GnlInf>
PaymentInitiationStatusIdentification	<PmtInitnStsId></PmtInitnStsId>
CreationDateTime	<CreDtTm></CreDtTm>
EndGeneralInformation	</GnlInf>
OriginalGroupReferenceInformationAndStatus	<OrgnlGrpRefInfAndSts>
GroupIdentification	<GrpId></GrpId>
OriginalMessageType	<OrgnlMsgTp></OrgnlMsgTp>
SettlementModelType	<SttlmMdlTp></SttlmMdlTp>
DecisionIndicator	<Declnd>False</Declnd>
GroupStatus	<GrpSts></GrpSts>
StatusReason	<StsRsn>
BilaterallyAgreed	<BilyAgrd></BilyAgrd>
EndStatusReason	</StsRsn>
EndOriginalGroupReferenceInformationAndStatus	</OrgnlGrpRefInfAndSts>
OriginalPaymentInformation	<OrgnlPmtInf>
RequestExecutionDate	<ReqdExctnDt></ReqdExctnDt>
OriginalTransactionReferenceInformationAndStatus	<OrgnlTxRefInfAndSts>
PaymentIdentification	<PmtId>
InstructionIdentification	<InstrId></InstrId>
EndToEndIdentification	<EndToEndId></EndToEndId>
EndPaymentIdentification	</PmtId>
TransactionStatus	<TxSts></TxSts>
StatusReason	<StsRsn>
BilaterallyAgreed	<BilyAgrd></BilyAgrd>
EndStatusReason	</StsRsn>
AdditionalInformation	<AddtlInf></AddtlInf>
EndOriginalTransactionReferenceInformationAndStatus	</OrgnlTxRefInfAndSts>
EndOriginalPaymentInformation	</OrgnlPmtInf>
End of SSP Proprietary Data	</SspPrtryDt>
End of Proprietary Data	</PrtryDt>
End Message Type	</pain.998.001.01>

Attributes:

name of attribute	format	short description	description
<pain.998.001.01>		Message Type	SSP proprietary message for Ancillary system interface
		Mandatory	Validation: [1..1]
<PrtryDt>		Proprietary Data	Proprietary Data
		Mandatory	Validation: [1..1]
<Tp></Tp>		Proprietary Data type	Proprietary Data type
		Mandatory	Validation: [1..1]
<SspPrtryDt>		SSP Proprietary Data	SSP Proprietary Data
		Mandatory	Validation: [1..1]
<GnlInf>		GeneralInformation	
		Mandatory	Validation: [1..1]
<PmtInItStsId></PmtInItStsId>	35x	PaymentInitiationStatusIdentification	Reference assigned by the ASI to unambiguously identify the status message
		Mandatory	Validation: [1..1]
<CreDtTm></CreDtTm>	ISODateTime	CreationDateTime	Date and time at which the credit transfer initiation was created by the initiating party
		Mandatory	Validation: [1..1]
</GnlInf>		EndGeneralInformation	
		Mandatory	Validation: [1..1]
<OrgnlGrpRefInfAndSts>		OriginalGroupReferenceInformationAndStatus	
		Mandatory	Validation: [1..1]
<GrpId></GrpId>	35x	GroupIdentification	Reference assigned by the sender to identify the group of individual transfers being sent Filled with the field "GroupIdentification" of the original message.
		Mandatory	Validation: [1..1]
<OrgnlMsgTp></OrgnlMsgTp>	35x	OriginalMessageType	Specifies the message type for which the status is reported: "ASTransferInitiation"
		Mandatory	Validation: [1..1]
<SttlmMdlTp></SttlmMdlTp>		SettlementModelType	Specifies the generic settlement Procedure 1000 = Procedure 1 (Liquidity transfer) 2000 = Procedure 2 (Real time settlement) 3000 = Procedure 3 (Bilateral settlement) 4000 = Procedure 4 (Standard multilateral settlement) 5000 = Procedure 5 (Simultaneous multilateral)

name of attribute	format	short description	description
		Mandatory	<p>settlement) 6000 = Procedure 6 (Settlement on dedicated liquidity)</p> <p>It is identical to the model of payment indicated in the original message</p> <p>Validation: [1..1]</p>
<Declnd>-</Declnd>	True/False	DecisionIndicator	<p>TRUE = Receipt Requested The ASI is waiting for a Receipt to have the decision of the AS about the use of the Guarantee Mechanism</p> <p>Not used in other cases</p> <p>Validation: [0..1]</p>
<GrpSts>-</GrpSts>	Max4Alphan umericText	GroupStatus	<p>Status information concerning the group of payment transactions included in the original message.</p> <p>ACSC = AcceptedSettlementCompleted Settlement on the debtor's account has been completed for all the transactions in the file. There is no list of single positions because they are all settled.</p> <p>INVL = Invalid The input file cannot be processed because of error</p> <p>PART = PartiallyAccepted A number of transactions have been accepted, whereas another number of transactions have not achieved "settled" status. The status of each transaction is indicated at Payment level in the list of single positions. 'PART' is also used if no transactions have been executed. In case of model 3 with single notification the group status will be always PART when the file is not globally rejected.</p> <p>REVR = Reversed The file which was previously "PartiallyAccepted" is now totally rejected after a reversing procedure of the transactions which were settled</p> <p>RJCT = Rejected Payment initiation or individual transaction included in the payment initiation has been rejected or revoked. The whole file is rejected</p> <p>RJDA = RejectedDisagreement Disagreement of the CB in case of transactions relative to excluded Settlement Bank or excluded AS. The whole file is rejected</p> <p>Validation: [0..1]</p>
<StsRsn>		StatusReason	<p>Used to -indicate the failure reason in case of complete reject for failure -the reason for a reverse -the error code in case of invalid input file</p> <p>Otherwise not used.</p> <p>Validation: [0..1] Error code in case TransactionStatus is "INVL" Failure reason in case TransactionStatus is "RJCT" or "RJDA"</p>
<BilyAgrd>-</BilyAgrd>	Max4Alphan umericText	BilaterallyAgreed	<p>-Error codes specified by ASI (A0xx) in case of invalid input message</p> <p>-In case of reject of a file after Reverse: "GANR" if the AS decision to use the guarantee account was negative, "GALL" if there is a lack of liquidity on the guarantee account</p>

name of attribute	format	short description	description
			-Failure reason in case of complete rejection of a file: RVOK = Revoke.The file has been revoked RJSP = RejectedSettlementPeriod.The file is rejected because the Settlement period time is reached. RDIB = File rejected at cutoff time due to insufficiency balance in the account to be decreased EXAS = File rejected for AS exclusion EXSB = File rejected because it contains a transaction relative to an excluded settlement bank DPNS = Daylight settlement period has not started
		Mandatory	Validation: [1..1]
</StsRsn>		EndStatusReason	
		Optional	Validation: [0..1]
</OrgnlGrpRefInfAndSts>		EndOriginalGroupReferenc eInformationAndStatus	
		Mandatory	Validation: [1..1]
<OrgnlPmtInf>		OriginalPaymentInformation	
		Optional	Validation: [0..n]
<ReqdExctnDt>- </ReqdExctnDt>	ISODate	RequestExecutionDate	Date at which the initiating party requests that the payment instruction be processed (=settlement date)
		Optional	Validation: [0..1]
<OrgnlTxRefInfAndSts>		OriginalTransactionReferen ceInformationAndStatus	
		Mandatory	Validation: [1..1]
<PmtId>		PaymentIdentification	Set of elements to provide further means of referencing a payment transaction
		Mandatory	Validation: [1..1]
<InstrId>-</InstrId>	16x	InstructionIdentification	Unique and unambiguous identifier for a payment instruction assigned by the initiating party =Identification indicated in the original message
		Mandatory	Validation: [1..1]
<EndToEndId>- </EndToEndId>	16x	EndToEndIdentification	Unique and unambiguous identification of a payment transaction, as assigned by any of the parties on the initiating side, that will be passed on throughout the entire end-to-end chain
		Mandatory	Validation: [1..1]
</PmtId>		EndPaymentIdentification	End of Set of elements to reference a payment transaction
		Mandatory	Validation: [1..1]
<TxSts>-</TxSts>		TransactionStatus	Status of a transaction included in the original message ACSC = AcceptedSettlementCompleted

name of attribute	format	short description	description
			Settlement on the debtor's account has been completed.
			INVL = Invalid The input payment cannot be processed because of error
			COPS = CurrentOrderPartiallySettled Current order from AS has been partially settled
			REVR = Reversed Reject of a transaction which was previously settled
			RJCT = Rejected Payment initiation or individual transaction included in the payment initiation has been rejected or revoked.
			RJDA = RejectedDisagreement Disagreement of the CB in case of transactions relative to excluded Settlement Bank or excluded AS. The transaction is rejected..
		Optional	Validation: [0..1]
<StsRsn>		StatusReason	Error code in case TransactionStatus is "INVL" Failure reason in case TransactionStatus is"RJCT"
		Optional	Validation: [0..1]
<BilyAgrd>-</BilyAgrd>	Max4AlphanumericText	BilaterallyAgreed	-Error code specified by ASI (A0xx) in case of invalid payment
			-Failure reason in case of payment rejected RVOK = Revoke The payment has been revoked RJSP = RejectedSettlementPeriod. The payment is rejected because the Settlement period time is reached. DPNS = DaySettlementPeriodNotStarted. Daylight settlement period has not started RDIB = RejectedDecreaseInsufficientBalance. Decrease rejected due to insufficient balance GENE = Generic Error EXSB = Exclusion Settlement Bank
		Mandatory	Validation: [1..1]
</StsRsn>		EndStatusReason	
		Optional	Validation: [0..1]
<AddtlInf>-</AddtlInf>	18d	AdditionalInformation	Settled amount of a current order which is partially settled
		Optional	Validation: [0..1]
</OrgnlTxRefInfAndSts>		EndOriginalTransactionReferenceInformationAndStatus	
		Mandatory	Validation: [1..1]
</OrgnlPmtInf>		EndOriginalPaymentInformation	
		Mandatory	Validation: [1..1]
</SspPrtryDt>		End of SSP Proprietary Data	End of SSP Proprietary Data
		Mandatory	Validation: [1..1]

name of attribute	format	short description	description
</PrtryDt>		End of Proprietary Data Mandatory	Validation: [1..1]
</pain.998.001.01>		End Message Type Mandatory	Validation: [1..1]

Error Codes:

ASInitiationStatus_1

Scope: Sample of ASInitiationStatus used to reject the input file for error in the data

In case of error at payment level, the whole file has the status "invalid" and only the erroneous payments will be listed with their error code. In case of error at GroupHeader level the optional OriginalPaymentInformation part of the message is not used.

Message Type	<pain.998.001.01>
Proprietary Data	<PrtryDt>
Proprietary Data type	<Tp>ASInitiationStatus</Tp>
SSP Proprietary Data	<SspPrtryDt>
GeneralInformation	<GnlInf>
PaymentInitiationStatusIdentification	<PmtInItStsId>ABC1234</PmtInItStsId>
CreationDateTime	<CreDtTm>2007-01-01T12:00:00</CreDtTm>
EndGeneralInformation	</GnlInf>
OriginalGroupReferenceInformationAndStatus	<OrgnlGrpRefInfAndSts>
GroupIdentification	<Grpld>ABCD1234</Grpld>
OriginalMessageType	<OrgnlMsgTp>ASTransferInitiation</OrgnlMsgTp>
SettlementModelType	<SttlmMdlTp>3000</SttlmMdlTp>
GroupStatus	<GrpSts>INVL</GrpSts>
EndOriginalGroupReferenceInformationAndStatus	</OrgnlGrpRefInfAndSts>
OriginalPaymentInformation	<OrgnlPmtInf>
RequestExecutionDate	<ReqdExctnDt>2007-01-01</ReqdExctnDt>
OriginalTransactionReferenceInformationAndStatus	<OrgnlTxRefInfAndSts>
PaymentIdentification	<PmtId>
InstructionIdentification	<InstrId>ABCD123456</InstrId>
EndToEndIdentification	<EndToEndId>ABCD123456</EndToEndId>
EndPaymentIdentification	</PmtId>
TransactionStatus	<TxSts>INVL</TxSts>
StatusReason	<StsRsn>
BilaterallyAgreed	<BilyAgrd>A018</BilyAgrd>
EndStatusReason	</StsRsn>
EndOriginalTransactionReferenceInformationAndStatus	</OrgnlTxRefInfAndSts>
EndOriginalPaymentInformation	</OrgnlPmtInf>
End of SSP Proprietary Data	</SspPrtryDt>
End of Proprietary Data	</PrtryDt>
End Message Type	</pain.998.001.01>

ASInitiationStatus_1c

Scope: Sample of ASInitiationStatus used to reject the input file for general error in the data (message sent at the wrong time in the procedure / cycle)

In case of error in the Header or a general error, the whole file is "invalid". The GroupStatus is "Invalid" and the error code is indicated in StatusReason. The optional OriginalPaymentInformation part of the message is not used.

Message Type	<pain.998.001.01>
Proprietary Data	<PrtryDt>
Proprietary Data type	<Tp>ASInitiationStatus</Tp>
SSP Proprietary Data	<SspPrtryDt>
GeneralInformation	<GnlInf>
PaymentInitiationStatusIdentification	<PmtInItStsId>ABCD1234</PmtInItStsId>
CreationDateTime	<CreDtTm>2007-01-01T12:00:00</CreDtTm>
EndGeneralInformation	</GnlInf>
OriginalGroupReferenceInformationAndStatus	<OrgnlGrpRefInfAndSts>
GroupIdentification	<GrpId>ABCD789</GrpId>
OriginalMessageType	<OrgnlMsgTp>ASTransferInitiation</OrgnlMsgTp>
SettlementModelType	<SttlmMdlTp>6000</SttlmMdlTp>
GroupStatus	<GrpSts>INVL</GrpSts>
StatusReason	<StsRsn>
BilaterallyAgreed	<BilyAgrd>A034</BilyAgrd>
EndStatusReason	</StsRsn>
EndOriginalGroupReferenceInformationAndStatus	</OrgnlGrpRefInfAndSts>
End of SSP Proprietary Data	</SspPrtryDt>
End of Proprietary Data	</PrtryDt>
End Message Type	</pain.998.001.01>

ASInitiationStatus_1d

Scope: Sample of ASInitiationStatus used to reject the input file for error in the data

In case of error in the Header or a general error, the whole file is "invalid" .The GroupStatus is "Invalid" and the error code is indicated in StausReason.The optional OriginalPaymentInformation part of the message is not used.

Message Type	<pain.998.001.01>
Proprietary Data	<PrtryDt>
Proprietary Data type	<Tp>ASInitiationStatus</Tp>
SSP Proprietary Data	<SspPrtryDt>
GeneralInformation	<GnlInf>
PaymentInitiationStatusIdentification	<PmtInitnStsId>ABCD1234</PmtInitnStsId>
CreationDateTime	<CreDtTm>2007-01-01T12:00:00</CreDtTm>
EndGeneralInformation	</GnlInf>
OriginalGroupReferenceInformationAndStatus	<OrgnlGrpRefInfAndSts>
GroupIdentification	<Grpld>ABCD789</Grpld>
OriginalMessageType	<OrgnlMsgTp>ASTransferInitiation</OrgnlMsgTp>
SettlementModelType	<SttlmMdlTp>4000</SttlmMdlTp>
GroupStatus	<GrpSts>INVL</GrpSts>
StatusReason	<StsRsn>
BilaterallyAgreed	<BilyAgrd>A005</BilyAgrd>
EndStatusReason	</StsRsn>
EndOriginalGroupReferenceInformationAndStatus	</OrgnlGrpRefInfAndSts>
End of SSP Proprietary Data	</SspPrtryDt>
End of Proprietary Data	</PrtryDt>
End Message Type	</pain.998.001.01>

ASInitiationStatus_2

Scope: In Procedure 6, the transactions included in the ASTransferInitiation file can be partially executed. The role of ASInitiationStatus is to indicate the list of these transactions with their result (Settled or not)
The ASInitiationStatus is composed of a first mandatory part (Group level) and one optional repetitive part (Transaction level) :

In case of partial execution of the input file, the ASInitiationStatus contains all the references of the transaction with their status and error code in case of failure.

Message Type	<pain.998.001.01>
Proprietary Data	<PrtryDt>
Proprietary Data type	<Tp>ASInitiationStatus</Tp>
SSP Proprietary Data	<SspPrtryDt>
GeneralInformation	<GnlInf>
PaymentInitiationStatusIdentification	<PmtInitnStsId>ABCD1234</PmtInitnStsId>
CreationDateTime	<CreDtTm>2007-01-01T12:00:00</CreDtTm>
EndGeneralInformation	</GnlInf>
OriginalGroupReferenceInformationAndStatus	<OrgnlGrpRefInfAndSts>
GroupIdentification	<Grpld>ABCD1234</Grpld>
OriginalMessageType	<OrgnlMsgTp>ASTransferInitiation</OrgnlMsgTp>
SettlementModelType	<SttlmMdlTp>6000</SttlmMdlTp>
GroupStatus	<GrpSts>PART</GrpSts>
EndOriginalGroupReferenceInformationAndStatus	</OrgnlGrpRefInfAndSts>
OriginalPaymentInformation	<OrgnlPmtInf>
RequestExecutionDate	<ReqdExctnDt>2007-01-01</ReqdExctnDt>
OriginalTransactionReferenceInformationAndStatus	<OrgnlTxRefInfAndSts>
PaymentIdentification	<PmtId>
InstructionIdentification	<InstrId>ABCD1234</InstrId>
EndToEndIdentification	<EndToEndId>ABCD1234</EndToEndId>
EndPaymentIdentification	</PmtId>
TransactionStatus	<TxSts>COPS</TxSts>
AdditionalInformation	<AddtlInf>123456.78</AddtlInf>
EndOriginalTransactionReferenceInformationAndStatus	</OrgnlTxRefInfAndSts>
EndOriginalPaymentInformation	</OrgnlPmtInf>
OriginalPaymentInformation	<OrgnlPmtInf>
RequestExecutionDate	<ReqdExctnDt>2007-01-01</ReqdExctnDt>
OriginalTransactionReferenceInformationAndStatus	<OrgnlTxRefInfAndSts>
PaymentIdentification	<PmtId>
InstructionIdentification	<InstrId>XYZ987</InstrId>
EndToEndIdentification	<EndToEndId>XYZ987</EndToEndId>
EndPaymentIdentification	</PmtId>
TransactionStatus	<TxSts>ACSC</TxSts>
EndOriginalTransactionReferenceInformationAndStatus	</OrgnlTxRefInfAndSts>
EndOriginalPaymentInformation	</OrgnlPmtInf>
End of SSP Proprietary Data	</SspPrtryDt>
End of Proprietary Data	</PrtryDt>
End Message Type	</pain.998.001.01>

ASInitiationStatus_3

Scope: When the ASInitiationStatus is sent to confirm the execution of or reject (for invalid message at GeneralInformation level, disagreement, or non settlement) the complete ASTransferInitiation message, it is reduced to the first mandatory part GeneralInformation / OriginalGroupReferenceInformationAndStatus which contains the GroupStatus and the StatusReason. The repetitive optional parts which refer the transactions are not specified,

Message Type	<pain.998.001.01>
Proprietary Data	<PrtryDt>
Proprietary Data type	<Tp>ASInitiationStatus</Tp>
SSP Proprietary Data	<SspPrtryDt>
GeneralInformation	<GnlInf>
PaymentInitiationStatusIdentification	<PmtInitnStsId>ABCD1234</PmtInitnStsId>
CreationDateTime	<CreDtTm>2007-01-01T12:00:00</CreDtTm>
EndGeneralInformation	</GnlInf>
OriginalGroupReferenceInformationAndStatus	<OrgnlGrpRefInfAndSts>
GroupIdentification	<GrpId>ABCD1234</GrpId>
OriginalMessageType	<OrgnlMsgTp>ASTransferInitiation</OrgnlMsgTp>
SettlementModelType	<SttlmMdlTp>4000</SttlmMdlTp>
GroupStatus	<GrpSts>RJDA</GrpSts>
StatusReason	<StsRsn>
BilaterallyAgreed	<BilyAgrd>EXSB</BilyAgrd>
EndStatusReason	</StsRsn>
EndOriginalGroupReferenceInformationAndStatus	</OrgnlGrpRefInfAndSts>
End of SSP Proprietary Data	</SspPrtryDt>
End of Proprietary Data	</PrtryDt>
End Message Type	</pain.998.001.01>

ASInitiationStatus_4

Scope: This ASInitiationStatus sample is sent by the ASI to request a decision from the AS on the use of the Guarantee Mechanisms. In this case the ASInitiationStatus contains the list of all the transactions with the TransactionStatus "AcceptedSettled" for the debits which are settled and the value "Rejected" for the debits which are not settled and for all the credits. The StatusReason is filled with 'RDIB' only for the rejected debit transactions, it is not used for the rejected credit transaction. The value of the DecisionIndicator is "True"

Message Type	<pain.998.001.01>
Proprietary Data	<PrtryDt>
Proprietary Data type	<Tp>ASInitiationStatus</Tp>
SSP Proprietary Data	<SspPrtryDt>
GeneralInformation	<GnlInf>
PaymentInitiationStatusIdentification	<PmtInItStsId>ABCD1234</PmtInItStsId>
CreationDateTime	<CreDtTm>2007-01-01T12:00:00</CreDtTm>
EndGeneralInformation	</GnlInf>
OriginalGroupReferenceInformationAndStatus	<OrgnlGrpRefInfAndSts>
GroupIdentification	<Grpld>ABCD1234</Grpld>
OriginalMessageType	<OrgnlMsgTp>ASTransferInitiation</OrgnlMsgTp>
SettlementModelType	<SttlmMdlTp>4000</SttlmMdlTp>
DecisionIndicator	<Declnd>>true</Declnd>
GroupStatus	<GrpSts>PART</GrpSts>
EndOriginalGroupReferenceInformationAndStatus	</OrgnlGrpRefInfAndSts>
OriginalPaymentInformation	<OrgnlPmtInf>
RequestExecutionDate	<ReqdExctnDt>2007-01-01</ReqdExctnDt>
OriginalTransactionReferenceInformationAndStatus	<OrgnlTxRefInfAndSts>
PaymentIdentification	<PmtId>
InstructionIdentification	<InstrId>ABCD1234</InstrId>
EndToEndIdentification	<EndToEndId>ABCD1234</EndToEndId>
EndPaymentIdentification	</PmtId>
TransactionStatus	<TxSts>RJCT</TxSts>
StatusReason	<StsRsn>
BilaterallyAgreed	<BilyAgrd>RDIB</BilyAgrd>
EndStatusReason	</StsRsn>
EndOriginalTransactionReferenceInformationAndStatus	</OrgnlTxRefInfAndSts>
EndOriginalPaymentInformation	</OrgnlPmtInf>
OriginalPaymentInformation	<OrgnlPmtInf>
RequestExecutionDate	<ReqdExctnDt>2007-01-01</ReqdExctnDt>
OriginalTransactionReferenceInformationAndStatus	<OrgnlTxRefInfAndSts>
PaymentIdentification	<PmtId>
InstructionIdentification	<InstrId>XYZ987</InstrId>
EndToEndIdentification	<EndToEndId>XYZ987</EndToEndId>
EndPaymentIdentification	</PmtId>
TransactionStatus	<TxSts>RJCT</TxSts>
EndOriginalTransactionReferenceInformationAndStatus	</OrgnlTxRefInfAndSts>
EndOriginalPaymentInformation	</OrgnlPmtInf>
End of SSP Proprietary Data	</SspPrtryDt>
End of Proprietary Data	</PrtryDt>
End Message Type	</pain.998.001.01>

ASInitiationStatus_5

Scope: This ASInitiationStatus sample is sent by the ASI to confirm a complete reject of a file after reversing procedure.

When the ASI receives a Receipt with a negative decision to use the Guarantee account or if there is a lack of liquidity on the guarantee account the reversing procedure is initiated and the ASI sends to the AS an ASInitiationStatus with the list of all the transactions.

The StatusReason at Group level indicates the Reverse Reason :

- . Negative decision from the AS
- . Lack of liquidity on the Guarantee account

The TransactionStatus of the debit transactions which were previously "AcceptedSettlementCompleted" is changed with the status "Reversed"

-The TransactionStatus of the other transactions remain "Rejected" as previously with the StatusReason code 'RDIB' for rejected debit transactions.

Message Type	<pain.998.001.01>
Proprietary Data	<PrtryDt>
Proprietary Data type	<Tp>ASInitiationStatus</Tp>
SSP Proprietary Data	<SspPrtryDt>
GeneralInformation	<GnlInf>
PaymentInitiationStatusIdentification	<PmtInitnStsId>ABCD1234</PmtInitnStsId>
CreationDateTime	<CreDtTm>2007-01-01T12:00:00</CreDtTm>
EndGeneralInformation	</GnlInf>
OriginalGroupReferenceInformationAndStatus	<OrgnlGrpRefInfAndSts>
GroupIdentification	<GrpId>ABCD1234</GrpId>
OriginalMessageType	<OrgnlMsgTp>ASTransferInitiation</OrgnlMsgTp>
SettlementModelType	<StlmMdlTp>4000</StlmMdlTp>
GroupStatus	<GrpSts>REVR</GrpSts>
StatusReason	<StsRsn>
BilaterallyAgreed	<BilyAgrd>GANR</BilyAgrd>
EndStatusReason	</StsRsn>
EndOriginalGroupReferenceInformationAndStatus	</OrgnlGrpRefInfAndSts>
OriginalPaymentInformation	<OrgnlPmtInf>
RequestExecutionDate	<ReqdExctnDt>2007-01-01</ReqdExctnDt>
OriginalTransactionReferenceInformationAndStatus	<OrgnlTxRefInfAndSts>
PaymentIdentification	<PmtId>
InstructionIdentification	<InstrId>ABCD1234</InstrId>
EndToEndIdentification	<EndToEndId>ABCD1234</EndToEndId>
EndPaymentIdentification	</PmtId>
TransactionStatus	<TxSts>REVR</TxSts>
EndOriginalTransactionReferenceInformationAndStatus	</OrgnlTxRefInfAndSts>
EndOriginalPaymentInformation	</OrgnlPmtInf>
OriginalPaymentInformation	<OrgnlPmtInf>
RequestExecutionDate	<ReqdExctnDt>2007-01-01</ReqdExctnDt>
OriginalTransactionReferenceInformationAndStatus	<OrgnlTxRefInfAndSts>
PaymentIdentification	<PmtId>
InstructionIdentification	<InstrId>XYZ987</InstrId>
EndToEndIdentification	<EndToEndId>XYZ987</EndToEndId>
EndPaymentIdentification	</PmtId>
TransactionStatus	<TxSts>RJCT</TxSts>
EndOriginalTransactionReferenceInformationAndStatus	</OrgnlTxRefInfAndSts>
EndOriginalPaymentInformation	</OrgnlPmtInf>
End of SSP Proprietary Data	</SspPrtryDt>
End of Proprietary Data	</PrtryDt>

End Message Type

</pain.998.001.01>

ASInitiationStatus_6

Scope: Sample of ASInitiationStatus used to confirm the complete execution file
In the Header the GroupStatus is "ACSC" and the StatusReason is not used.

Message Type	<pain.998.001.01>
Proprietary Data	<PrtryDt>
Proprietary Data type	<Tp>ASInitiationStatus</Tp>
SSP Proprietary Data	<SspPrtryDt>
GeneralInformation	<GnlInf>
PaymentInitiationStatusIdentification	<PmtInitnStsId>ABCD1234</PmtInitnStsId>
CreationDateTime	<CreDtTm>2007-01-01T12:00:00</CreDtTm>
EndGeneralInformation	</GnlInf>
OriginalGroupReferenceInformationAndStatus	<OrgnlGrpRefInfAndSts>
GroupIdentification	<Grpld>ABCD789</Grpld>
OriginalMessageType	<OrgnlMsgTp>ASTransferInitiation</OrgnlMsgTp>
SettlementModelType	<SttlmMdlTp>4000</SttlmMdlTp>
GroupStatus	<GrpSts>ACSC</GrpSts>
EndOriginalGroupReferenceInformationAndStatus	</OrgnlGrpRefInfAndSts>
End of SSP Proprietary Data	</SspPrtryDt>
End of Proprietary Data	</PrtryDt>
End Message Type	</pain.998.001.01>

6. 6. 2 ASTransferInitiation

SSP Proprietary Messages

ASTransferInitiation

Scope: This message is sent by the AS to transfer the transaction files to be executed by the SSP. The message is used for all the models but it can be used as single where relevant.

Several PaymentInformation can be included in the message. The ASI will accept one and only one PaymentTransaction by PaymentInformation.

-----Identification of the AS-----

When the message is sent by a CB or SSP operator (on behalf of the AS), the BIC of the AS is filled in the InitiatingParty. When sent by the CB, the sender DN has to be the back office DN of the CB of the AS. When sent by the SSP operator the sender DN has to be the back office DN of the CB 'XE'.

-----Settlement-----

The accounts in the SSP which must be settled by the PM are defined by the FirstAgent and the FinalAgent. These two attributes are mandatory in each transaction.

The Settlement module has to debit the FirstAgent and to credit the FinalAgent.

The FirstAgent and the FinalAgent can be the same for model 2 & 3.

The Debtor and the Creditor are optional.

The Debtor is used to define an ordering institution before the FirstAgent.

The Creditor is used to define a beneficiary after the FinalAgent.

-----Addressing validations-----

Addressing depends on the sender of the message, on the Model and on the Payment scheme code.

<pain.998.001.xx>

Structure:

Message Type	<pain.998.001.01>
Proprietary Data	<PrtryDt>
Proprietary Data type	<Tp></Tp>
SSP Proprietary Data	<SspPrtryDt>
GroupHeader	<GrpHdr>
GroupIdentification	<Grpld></Grpld>
CreationDateTime	<CreDtTm></CreDtTm>
ControlSum	<CtrlSum>.90</CtrlSum>
NumberOfTransactions	<NbOfTx></NbOfTx>
Priority	<Prty></Prty>
SettlementModelType	<StlmMdlTp></StlmMdlTp>
ScheduledTime	<SchldTm>
InformationPeriodType	<InfPrdTp></InfPrdTp>
Choice	xorFrTmTmPrd
FromTime	<FrTm></FrTm>
Duration	<TmPrd></TmPrd>
EndChoice	/xorFrTmTmPrd
EndScheduledTime	</SchldTm>
SettlementPeriodType	<StlmPrdTp>
Choice	xorToTmTmPrd
To Time	<ToTm></ToTm>
Duration	<TmPrd></TmPrd>
Choice	/xorToTmTmPrd
EndSettlementPeriodType	</StlmPrdTp>
InitiatingParty	<InitgPty>
Financial institution	<FI>
BIC	<BIC></BIC>
End of financial institution	</FI>
EndInitiatingParty	</InitgPty>
Counterpart AS	<CtpAS>

Financial institution	<FI>
BIC	<BIC></BIC>
End of financial institution	</FI>
End of Counterpart AS	</CtpAS>
EndGroupHeader	</GrpHdr>
PaymentInformation	<PmtInf>
RequestedExecutionDate	<ReqdExctnDt></ReqdExctnDt>
CreditTransferTypeIdentification	<CdtTrfTpId>
SettlementPriorityChoice	<SttlmPrty>
PaymentScheme	<PmtSchme>
Code	<Cd></Cd>
EndPaymentScheme	</PmtSchme>
EndSettlementPriorityChoice	</SttlmPrty>
EndCreditTransferTypeIdentification	</CdtTrfTpId>
Debtor	<Dbtr>
Name of the account. An additional identification	<Nm></Nm>
Financial institution	<FI>
BIC	<BIC></BIC>
End of financial institution	</FI>
End of debtor	</Dbtr>
DebtorAccount	<DbtrAcct>
Simple Identification Information	<DmstAcct>
Identification	<Id></Id>
End of simple Identification Information	</DmstAcct>
EndDebtorAccount	</DbtrAcct>
First Agent	<FrstAgt>
BIC	<BIC></BIC>
End First Agent	</FrstAgt>
FirstAgentAccount	<FrstAgtAcct>
Simple Identification Information	<DmstAcct>
Identification	<Id></Id>
End of simple Identification Information	</DmstAcct>
EndFirstAgentAccount	</FrstAgtAcct>
Information payment transaction.	<PmtTx>
PaymentIdentification	<PmtId>
InstructionIdentification	<InstrId></InstrId>
EndToEndIdentification	<EndToEndId></EndToEndId>
EndPaymentIdentification	</PmtId>
Amount	<Amt>
InstructedAmount	<InstAmt></InstAmt>
End of Amount	</Amt>
Creditor	<Cdtr>
Name	<Nm></Nm>
Financial institution	<FI>
BIC	<BIC></BIC>
End of financial institution	</FI>
End of Creditor	</Cdtr>
CreditorAccount	<CdtrAcct>
Simple Identification Information	<DmstAcct>
Identification	<Id></Id>
End of simple Identification Information	</DmstAcct>
EndCreditorAccount	</CdtrAcct>

Final Agent					<FnIAgt>
BIC					<BIC></BIC>
End of Final Agent					</FnIAgt>
FinalAgentAccount					<FnIAgtAcct>
Simple Identification Information					<DmstAcct>
Identification					<Id></Id>
End of simple Identification Information					</DmstAcct>
EndFinalAgentAccount					</FnIAgtAcct>
RemittanceInformation					<RmtInf>
Unstructured					<Ustrd></Ustrd>
EndRemittanceInformation					</RmtInf>
End of Information payment transaction.					</PmtTx>
EndPaymentInformation					</PmtInf>
End of SSP Proprietary Data					</SspPrtryDt>
End of Proprietary Data					</PrtryDt>
End Message Type					</pain.998.001.01>

Attributes:

name of attribute	format	short description	description
<pain.998.001.01>		Message Type	SSP proprietary message for Ancillary system interface
		Mandatory	Validation: [1..1]
<PrtryDt>		Proprietary Data	Proprietary Data
		Mandatory	Validation: [1..1]
<Tp>-</Tp>		Proprietary Data type	Proprietary Data type
		Mandatory	Validation: [1..1]Always "ASTransferInitiation"
<SspPrtryDt>		SSP Proprietary Data	SSP Proprietary Data
		Mandatory	Validation: [1..1]
<GrpHdr>		GroupHeader	
		Mandatory	Validation: [1..1]
<Grpld>-</Grpld>	35x	GroupIdentification	Reference assigned by the sender to identify the group of individual transfers being sent
		Mandatory	Validation: [1..1] ASI checks GroupIdentification together with the sender BIC: this couple of tags have to be unique over a period of 5 days
<CreDtTm>-</CreDtTm>	RestrictedISODateTime	CreationDateTime	Date and time at which the transfer initiation was created
		Mandatory	Validation: [1..1]
<CtrlSum>-</CtrlSum>	DecimalNumber	ControlSum	Total of all the individual instructed amounts
		Optional	Validation: [0..1] If filled, ASI calculates the sum of the individual amounts in Payment Transaction and checks if it is equal to the ControlSum
<NbOfTxs>-</NbOfTxs>	15n	NumberOfTransactions	Number of individual transactions contained in the message, ie the number of occurrences of PaymentTransaction
		Optional	Validation: [0..1] If filled, ASI checks that this number is equal to the number of occurrences of PaymentTransaction in the message For Model 1 and 2: Must be "1" (if filled) For Model 6 code "CDS": Must be "1" (if filled)
<Prty>-</Prty>	4x	Priority	Priority of all the payments at Group level
		Optional	Validation: [0..1] The authorised code is : HIGH
<StlmMdlTp>-</StlmMdlTp>		SettlementModelType	Specifies the generic settlement Procedure 1000 = Procedure 1 (Liquidity transfer) 2000 = Procedure 2 (Real time settlement)

name of attribute	format	short description	description
			3000 = Procedure 3 (Bilateral settlement) 4000 = Procedure 4 (Standard multilateral settlement) 5000 = Procedure 5 (Simultaneous multilateral settlement) 6000 = Procedure 6 (Settlement on dedicated liquidity)
		Mandatory	Validation: [1..1] -Must belong to the following list: "1000"= Model 1 (Liquidity transfer) "2000" = Model 2 (Real time settlement) "3000" = Model 3 (Bilateral settlement) "4000" = Model 4 (Standard multilateral settlement) "5000" = Model 5 (Simultaneous multilateral settlement) "6000" = Model 6 (Settlement on dedicated liquidity accounts) ASI checks if the sender (or the InitiatingParty if filled in) has the right to make use of the indicated settlement model
<SchlddTm>		ScheduledTime	
		Optional	Validation: [0..1] The whole sequence cannot be used for settlement models 6 (i.e. if <StlmMdlTp>-</StlmMdlTp> =6000)
<InfPrdTp>-</InfPrdTp>		InformationPeriodType	Information = INFO The Settlement Bank is informed of the Scheduled Time but has not the possibility to disagree. Agreement = AGRE The Settlement Bank is informed of the Scheduled Time and has the possibility to disagree.
		Mandatory	Validation: [1..1] Models 1, 2: the possible code is "INFO"; models 3, 4, 5: the possible code is "AGRE" model 6 : the field is ignored
xorFrTmTmprd		Choice	
		Optional	Validation:
<FrTm>-</FrTm>	ISOTime	FromTime	ISOTime (hh:mm:ss) of the Scheduled Time
		Mandatory	Validation: [1..1] Must be later that the current time
<TmPrd>-</TmPrd>	ISOTime	Duration	ISOTime before the Scheduled Time
		Mandatory	Validation: [1..1] ASI adds the duration to the current system time to calculate the "FromTime" Value 00:00:00 is not allowed.
/xorFrTmTmprd		EndChoice	
		Optional	Validation:
</SchlddTm>		EndScheduledTime	
		Optional	Validation: [0..1]
<StlmPrdTp>		SettlementPeriodType	
		Optional	Validation:

name of attribute	format	short description	description
			[0..1] The whole sequence is ignored for settlement models 6 (<SttlmMdlTp>-</SttlmMdlTp> =6000)
xorToTmTmPrd		Choice Optional	Validation:
<ToTm>-</ToTm>	ISOTime	To Time Mandatory	ISOTime (hh:mm:ss) of the Settlement Period Validation: [1..1] Must be later that the current time It must be later that the ScheduledTime if present
<TmPrd>-</TmPrd>	ISOTime	Duration Mandatory	ISOTime before the Scheduled Time which indicates the duration of the settlement Validation: [1..1] - If the ScheduledTime is missing : ASI adds the duration to the current system time to calculate the "ToTime" - If the ScheduledTime is present : ASI adds the duration to the "Scheduled time" to calculate the "ToTime"
xorToTmTmPrd		Choice Optional	Validation:
</SttlmPrdTp>		EndSettlementPeriodType Optional	Validation: [0..1]
<InitgPty>		InitiatingParty Optional	Validation: [0..1] The optional sequence will be filled in only in case a CB or SSP operator is sending the message on behalf of an AS
<FI>		Financial institution Mandatory	Financial institution Validation: [1..1]
<BIC>-</BIC>	11x	BIC Mandatory	BIC Validation: [1..1] If the sender is a CB then the Initiating Party must be filled with a BIC of an authorised AS and member of this CB. If the sender is the SSP OT then the initiating party must be filled with a BIC of an authorised AS. In other cases, this field is ignored.
</FI>		End of financial institution Mandatory	End of financial institution Validation: [1..1]
</InitgPty>		EndInitiatingParty Optional	Validation: [0..1]
<CtpAS>		Counterpart AS Optional	Counterpart AS Validation:

name of attribute	format	short description	description
			[0..1]
<FI>		Financial institution	Financial institution
		Mandatory	Validation: [1..1]
<BIC>-</BIC>	11x	BIC	BIC
		Mandatory	It contains the BIC of the AS with which the cross AS settlement is made. Validation: [1..1] If the PaymentSchemeCode is "CDS", this tag is mandatory and should contain a valid AS BIC with which the sending AS is in relation. If the PaymentSchemeCode is not "CDS", this tag is forbidden
</FI>		End of financial institution	End of financial institution
		Mandatory	Validation: [1..1]
</CtpAS>		End of Counterpart AS	End of Counterpart AS
		Optional	Validation: [0..1]
</GrpHdr>		EndGroupHeader	
		Mandatory	Validation: [1..1]
<PmtInf>		PaymentInformation	Set of characteristics that applies to the debit side of the payment transactions
		Mandatory	Validation: [1..n] For settlement models 1, 2, 6 code "CDS": Only one occurrence is allowed. For model 3: In case the AS opted for single notification the number of transactions must not exceed 3000. If this number is exceeded the file will be rejected. - "Number of transactions too high."
<ReqdExctnDt>-</ReqdExctnDt>	RestrictedISODate	RequestedExecutionDate	Date at which the initiating party requests that the payment instruction be processed (=settlement date)
		Mandatory	Validation: [1..1] Must be the current business day
<CdtTrfTpId>		CreditTransferTypeIdentification	Set of elements that further identifies the type of credit transfer requested
		Optional	Validation: [0..1]
<StlmPrty>		SettlementPriorityChoice	Priority or specific payment
		Mandatory	Validation: [1..1] For procedure 6, all values in the current schema files are authorised. All the transactions must have a PaymentScheme/code and it must be the same in one single file. For procedure 1 to 5, only code "REP" is authorised. There can be both transactions with PaymentScheme / code "REP" and transactions without PaymentScheme /

name of attribute	format	short description	description
			code in one single file. In that case the CreditTransferTypeIdentification has to be omitted.
<PmtSchme>		PaymentScheme	Specific rulebook governing the rules of settlement
		Mandatory	Validation: [1..1]
<Cd>-</Cd>	Max3Alphan umericTxt	Code	"CDS" = Model 6 Cross AS Settlement between two AS "CUO" = Model 6 Current Order Current order sent either by an AS on behalf of a Settlement Bank "CSP" = Model 6 Connected SSP Automatic increase/decrease of liquidity by connected payments on SSP account "CHA" = Model 6 Connected Home Account Automatic increase/decrease of liquidity with credit lines managed in proprietary home account "COL" = Model 6 Auto-Collateral File of mandated payments to debit (credit) AS Auto collateral account and credit (debit) sub-accounts of Settlement Banks "REP" = Model 6 Auto-collateral for Repo countries Automatic increase/decrease of blocked liquidity by auto-collateralisation for repo countries "REP" = Model 1 to 5 REPO operations "STR" = Model 6 Specific Transactions Increase of dedicated liquidity triggered by specific transactions "SET" = Model 6 Settlement Settlement "SOR" = Model 6 Standing Order Code used only in ASTransferNotice to notify to the AS the funds booked on the Technical account - procedure 6 real-time after standing order execution
		Mandatory	Validation: [1..1] Code SOR is not allowed
</PmtSchme>		EndPaymentScheme	
		Mandatory	Validation: [1..1]
</SttlmPrty>		EndSettlementPriorityChoice	
		Mandatory	Validation: [1..1]
</CdtTrfTpId>		EndCreditTransferTypeIdentification	
		Optional	Validation: [0..1]
<Dbtr>		Debtor	Information about the debtor of a payment.
		Optional	Validation: [0..1]
<Nm>-</Nm>	Max62FINC haracterText	Name of the account. An additional identification	Name of the debtor Shall be mapped to the MT900 in field 72 with codeword

name of attribute	format	short description	description
		Optional	/ASDEBT/ (without truncation) In procedure 1, the Debtor name will be filled in the field 72 of the MT202 with /ASDB/ Validation: [0..1] The contents must comply with the FIN set of characters.
<FI>		Financial institution Optional	Financial institution Validation: [0..1]
<BIC>-</BIC>	11x	BIC Mandatory	BIC =BIC of the ordering institution If it is filled in Model 1, it will be copied in MT202 (field 52A) In others models, shall be mapped to the MT900 with codeword /ASDEBT/ Validation: [1..1] If filled, it must be a published SWIFT BIC For Model 6 code "CDS": If the FirstAgent is a technical account - procedure 6 real-time, this BIC is mandatory.
</FI>		End of financial institution Optional	End of financial institution Validation: [0..1]
</Dbtr>		End of debtor Optional	Validation: [0..1]
<DbtrAcct>		DebtorAccount Optional	Validation: [0..1]
<DmstAcct>		Simple Identification Information Mandatory	Simple Identification Information Validation: [1..1]
<Id>-</Id>	35x	Identification Mandatory	Identification of an entity In procedure 1, if a valid BIC is indicated as Debtor, the DebtorAccount will be field in the field 52A In procedure 1, if Debtor name and BIC are not present, the account number of the debtor will be filled in field 72 of MT202 with /ASDB/ If it is filled in model 1, it will be copied in MT202 (field 52A account number) In others models, shall be mapped to the MT900 with codeword /ASDEBT/ Validation: [1..1] The contents must comply with the FIN set of characters.
</DmstAcct>		End of simple Identification Information Mandatory	Validation: [1..1]
</DbtrAcct>		EndDebtorAccount Optional	Validation: [0..1]

name of attribute	format	short description	description
<FrstAgt>		First Agent Mandatory	Validation: [1..1]
<BIC>-</BIC>	11x	BIC Mandatory	BIC =BIC debited in the SSP Validation: [1..1] Checked in the framework of Addressing rules
</FrstAgt>		End First Agent Mandatory	End First Agent Validation: [1..1]
<FrstAgtAcct>		FirstAgentAccount Optional	Validation: [0..1]
<DmstAcct>		Simple Identification Information Mandatory	Simple Identification Information Validation: [1..1]
<Id>-</Id>	35x	Identification Mandatory	Identification of an entity Validation: [1..1] Model 1, 2, 3, 4, 5: ignored Model 6 : checked in the framework of addressing validation rules
</DmstAcct>		End of simple Identification Information Mandatory	Validation: [1..1]
</FrstAgtAcct>		EndFirstAgentAccount Optional	Validation: [0..1]
<PmtTx>		Information payment transaction. Mandatory	Payment processes required to transfer cash from the debtor to the creditor. Validation: [1..1] Only one occurrence of PaymentTransaction in PaymentInformation
<PmtId>		PaymentIdentification Mandatory	Set of elements to provide further means of referencing a payment transaction Validation: [1..1]
<InstrId>-</InstrId>	16x	InstructionIdentification Mandatory	Unique and unambiguous identifier for a payment instruction assigned by the initiating party Validation: [1..1] Must be unique between all InstructionIdentification in the message. Additionally, the reference of transaction, composed of BIC 11 of the AS which initiates the transaction (if the sender is an AS or the CB which sends on behalf of the AS) or of the Settlement Bank (If the sender is a

name of attribute	format	short description	description
			Settlement Bank) + InstructionIdentification must be unique over a period of 5 business days
<EndToEndId>-</EndToEndId>	16x	EndToEndIdentification Mandatory	Unique and unambiguous identification of a payment transaction, as assigned by any of the parties on the initiating side, that will be passed on throughout the entire end-to-end chain This identification must comply with the FIN set of characters and must not contain slashes, it will be mapped to the Settlement Bank on MT900/910 field 21 For the Model1, shall be on MT202 field 21 Validation: [1..1]
</PmtId>		EndPaymentIdentification Mandatory	End of Set of elements to reference a payment transaction Validation: [1..1]
<Amt>		Amount Mandatory	Validation: [1..1]
<InstAmt>-</InstAmt>	15d	InstructedAmount Mandatory	Amount of money to be transferred between debtor and creditor expressed in Euros Validation: [1..1] The amount must be compatible with the format 15d used in FIN messages, it must be different from zero. Additional Information:Format 15D (12 digits + separator[dot] + two decimals) Model 4, 5 : The total amount of debited payments to the AS Technical Account must be equal to the total amount of credited payments to the Technical Account
</Amt>		End of Amount Mandatory	End of Amount Validation: [1..1]
<Cdtr>		Creditor Optional	Validation: [0..1]
<Nm>-</Nm>	Max62FINC haracterText	Name Optional	Shall be mapped to the MT910 with codeword /ASCRED/ (without truncation) In procedure 1, the Creditor Name will be filled in the field 72 of the MT202 with codeword /ASCR/ Validation: [0..1] The contents must comply with the FIN set of characters.
<FI>		Financial institution Optional	Financial institution Validation: [0..1]
<BIC>-</BIC>	11x	BIC Mandatory	BIC =BIC of the final beneficiary (after the FinalAgent) If it is filled in Model 1, it will be copied in MT202 (field 58A) In others models, shall be mapped to the MT910 in field 72 with codeword /ASCRED/ Validation:

name of attribute	format	short description	description
			[1..1] If filled, it must be a published SWIFT BIC Model 6 code "CDS": If the FinalAgent is a technical account - procedure 6 real-time, this BIC is mandatory.
</FI>		End of financial institution	End of financial institution
		Optional	Validation: [0..1]
</Cdtr>		End of Creditor	
		Optional	Validation: [0..1]
<CdtrAcct>		CreditorAccount	
		Optional	Validation: [0..1]
<DmstAcct>		Simple Identification Information	Simple Identification Information
		Mandatory	Account of the final beneficiary Validation: [1..1]
<Id>-</Id>	35x	Identification	Identification of an entity
		Mandatory	The contents must comply with the FIN set of characters. In procedure 1, if a valid BIC is indicated as Creditor, the account number will be filled in field 58A of the MT202 In procedure 1, if Debtor name and BIC are not present, the account number of the creditor will be filled in field 72 of MT202 with /ASCR/ In others models, shall be mapped to the MT910 in field 72 with codeword /ASCRED/ Validation: [1..1]
</DmstAcct>		End of simple Identification Information	
		Mandatory	Validation: [1..1]
</CdtrAcct>		EndCreditorAccount	
		Optional	Validation: [0..1]
<FnIAgt>		Final Agent	Provides details about a system and about a member of a system
		Mandatory	Is the BIC of the account to be credited in the SSP Validation: [1..1]
<BIC>-</BIC>	11x	BIC	BIC
		Mandatory	Procedure 4 and procedure 5 :FirstAgent or FinalAgent must be a Technical Account Validation: [1..1] Checked in the framework of addressing validation rules
</FnIAgt>		End of Final Agent	End of Final Agent
		Mandatory	Validation: [1..1]
<FnIAgtAcct>		FinalAgentAccount	
		Optional	Validation:

name of attribute	format	short description	description
			[0..1]
<DmstAcct>		Simple Identification Information Mandatory	Simple Identification Information Validation: [1..1]
<Id>-</Id>	35x	Identification Mandatory	Identification of an entity Validation: [1..1] Model 1, 2, 3, 4, 5 :Ignored Model 6: Checked in the framework of addressing validation rules. FirstAgent and FinalAgent accounts must be different
</DmstAcct>		End of simple Identification Information Mandatory	Validation: [1..1]
</FnlAgtAcct>		EndFinalAgentAccount Optional	Validation: [0..1]
<RmtInf>		RemittanceInformation Optional	Validation: [0..1]
<Ustrd>-</Ustrd>	140x	Unstructured Mandatory	The contents must comply with the FIN set of characters. Model 1: Shall be mapped to the outgoing MT202 field 72 Model 6 (code CUO) : Shall be mapped to the remittance information of the payment transaction branch of the ASTransferNotice sent to the AS Others models : Shall be mapped to the MT900/910 field 72 Validation: [1..1] Not checked
</RmtInf>		EndRemittanceInformation Optional	Validation: [0..1]
</PmtTx>		End of Information payment transaction. Mandatory	Validation: [1..1]
</PmtInf>		EndPaymentInformation Mandatory	Validation: [1..1]
</SspPrtryDt>		End of SSP Proprietary Data Mandatory	End of SSP Proprietary Data Validation: [1..1]
</PrtryDt>		End of Proprietary Data Mandatory	Validation:

name of attribute	format	short description	description
			[1..1]
</pain.998.001.01>		End Message Type	
		Mandatory	Validation:
			[1..1]

Error Codes:

Order	Error code				Error Text / Validation/ Remark
	SSP	Y-copy	V-shape	XML	
A85				RJSP	Error Text: The payment is rejected because the Settlement period time is reached Validation: Transaction or file is rejected because it is unsettled at the end of the Settlement period Remark:
862	C2		TM01	2862	Error Text: Request out of cut-off time Validation: The request must be received during the operating hours of the ASI Remark:
A40				A040	Error Text: The AS is not authorised to request a Connected payment. Validation: When PaymentScheme code is "CSP", the flag authorising the AS to submit connected payments on behalf of the CB should be set to "yes" Remark:
A80				DPNS	Error Text: Daylight settlement period has not started Validation: Daylight settlement period has not started and the operation requested can only be performed in daylight. Remark:
A93				RJDA	Error Text: File / transaction was revoked by the CB after disagreement. Validation: File / transaction was revoked by the CB after disagreement. Remark:
A84				RJED	Error Text: Payment Reject at end of day Validation: Transaction remained unsettled at the end of the day Remark:
A86				RVOK	Error Text: The payment has been revoked Validation: The transaction was revoked Remark:
610	L1		AM04	RDIB	Error Text: Removal of payment because of missing cover or exceeding a limit. / Order rejected due to insufficient balance. Validation: Remark:
620	L2			EXSB	Error Text: Exclusion of payment by PM / Exclusion Settlement Bank Validation: Remark:
A92				EXAS	Error Text: The file / transaction is rejected because the AS is excluded Validation: The file / transaction is rejected because the AS is excluded Remark:
A90				COPS	Error Text: Current order partially settled Validation: Current order partially settled Remark:
A89				INVL	Error Text: Invalid file or transaction Validation: Invalid file or transaction

Order	Error code				Error Text / Validation/ Remark
	SSP	Y-copy	V-shape	XML	

Remark:

A88 RJCT **Error Text:** Payment initiation or individual transaction included in the payment initiation has been rejected.
Validation: Payment initiation or individual transaction included in the payment initiation has been rejected.
Remark:

A87 REVR **Error Text:** Rejection after reversing procedure
Validation: Rejection after reversing procedure
Remark:

A83 GENE **Error Text:** Generic error
Validation: Generic error
Remark:

1 A01 A001 **Error Text:** Sender not allowed
Validation: The sending DN must be linked in Static Data to
- a responsible CB of the AS related to the file or
- OT or
- an AS
Remark:

2 A02 A002 **Error Text:** AS missing or not allowed in InitiatingParty / SubjectDetails
Validation: If the DN is relative to a CB, then, if the message is sent on behalf of the AS, the Tag Initiating Party must be filled with a BIC of an authorised AS member of this CB.
Remark:

3 A19 A019 **Error Text:** Double GroupIdentification
Validation: The reference of the file, composed of:
BIC (11 characters) of the sender of the message +
GroupIdentification, must be unique
Remark:

5 A04 A004 **Error Text:** Invalid ControlSum
Validation: If <CtrlSum> is filled, it must be equal to the sum of the individual amounts in <PmtTx>
Remark:

6 A05 A005 **Error Text:** Invalid NumberOfTransactions
Validation: If <NbOfTx> (number of individual transactions contained in the message) is filled, it must be equal to the number of occurrences of <PmtTx>. In case of Procedures 1 and 2, this number must be equal to 1
Remark:

7 A06 A006 **Error Text:** Invalid PriorityType
Validation: Priority of all the payments in tag <Prty>, if filled, must be equal to "HIGH"
Remark:

8 A07 A007 **Error Text:** Invalid SettlementModelType
Validation: <SttlmMdlTp> must belong to the list: 1000, 2000, 3000, 4000, 5000, 6000
Remark:

9 A08 A008 **Error Text:** SettlementModelType not allowed for the sender

Order	Error code				Error Text / Validation/ Remark
	SSP	Y-copy	V-shape	XML	
					<p>Validation: <InitgPty> (or the sender of the message if <InitgPty> is not present) must be authorised to send this <SttlmMdlTp> according to Static Data</p> <p>Remark:</p>
10	A09			A009	<p>Error Text: Invalid InformationPeriodType</p> <p>Validation: If Procedures 1 or 2 are used, the <InfPrdTp>, if filled, must be "INFO". If Procedures 3 to 5 are used, the <InfPrdTp>, if filled, must be "AGRE"</p> <p>Remark:</p>
11	A10			A010	<p>Error Text: Invalid FromTime</p> <p>Validation: If filled, <FrTm> must be later than the current system time.</p> <p>Remark:</p>
12	A11			A011	<p>Error Text: Invalid ToTime</p> <p>Validation: If filled, <ToTm> must be later that the current time and later that the scheduled time if present.</p> <p>Remark:</p>
13	A02			A002	<p>Error Text: AS missing or not allowed in InitiatingParty / SubjectDetails</p> <p>Validation: If the sender of the message is a CB (on behalf of the AS) then the <BIC> in <InitgPty> must be filled with a BIC of an authorised AS of which this CB is responsible.</p> <p>Remark:</p>
14	A03			A003	<p>Error Text: Invalid date</p> <p>Validation: <ReqdExctnDt> in each payment must be the date of the business day.</p> <p>Remark:</p>
15	A13			A013	<p>Error Text: Invalid PaymentScheme code</p> <p>Validation: Tag <Cd> shall be filled only if <SttlmMdlTp> is 6000 then the Code has to be checked with the list of PaymentScheme codes for Procedure 6. / The same PaymentScheme code must be contained in all transactions of the message.</p> <p>Remark:</p>
16	A34			A034	<p>Error Text: Order or message out of sequence</p> <p>Validation: Tag <Cd> must be filled with a code that is consistent with the current phase of AS business (opening / closing of procedures and cycles)</p> <p>Remark:</p>
17	A14			A014	<p>Error Text: FirstAgent not allowed</p> <p>Validation: <BIC> in <FrstAgt> must be consistent with the addressing rules.</p> <p>Remark:</p>
18	A15			A015	<p>Error Text: FirstAgent Domestic account not allowed</p> <p>Validation: In the framework of Procedure 6, <FrstAgtAcct> must be consistent with the addressing rules.</p> <p>Remark:</p>
19	A33			A033	<p>Error Text: Inconsistency between SettlementModelType, FirstAgent and FinalAgent</p> <p>Validation: In the framework of Procedure 6, some business cases require the indication of a sub-account in <FrstAgtAcct></p> <p>Remark:</p>
20	A20			A020	<p>Error Text: Double payment identification</p>

Order	Error code				Error Text / Validation/ Remark
	SSP	Y-copy	V-shape	XML	

Validation: A reference of the payment is computed for each transaction in the file. If the sender is an AS or the CB which sends on behalf of the AS, the reference is composed of BIC (11 characters) of the AS which initiates the transaction + <InstrId>. If the sender is a CB the reference is composed of:
BIC (11 characters) of the Settlement Bank (or the CB) + <InstrId>. This reference must be unique over a period of 5 business days.

Remark:

23	A24	A024	Error Text: Amount unavailable Validation: <InstrAmt> must be different from zero / Format 15d must be used. Remark:
24	A23	A023	Error Text: Sum of debit from Technical account is not equal to sum of credit to Technical account Validation: In case of Procedure 4 or 5, the total amount of debited payments from AS Technical Account must be equal to the total amount of credited payments to the Technical Account Remark:
25	A16	A016	Error Text: FinalAgent not allowed Validation: <BIC> in <FnIAgt> must be consistent with the addressing rules. Remark:
26	A18	A018	Error Text: FirstAgent and FinalAgent accounts must be different Validation: FirstAgent and FinalAgent accounts must be different Remark:
27	A33	A033	Error Text: Inconsistency between SettlementModelType, FirstAgent and FinalAgent Validation: In the framework of Procedures 4 and 5, <BIC> in <FnIAgt> or <BIC> in <FrstAgt> must identify an AS Technical account. Remark:
28	A17	A017	Error Text: FinalAgent Domestic account not allowed Validation: In the framework of Procedure 6, <FnIAgtAcct> must be consistent with the addressing rules. Remark:
29	A33	A033	Error Text: Inconsistency between SettlementModelType, FirstAgent and FinalAgent Validation: <FnIAgtAcct> must identify a sub-account or account number in specific cases Remark:
30	A41	A041	Error Text: Debtor BIC is not a published SWIFT BIC Validation: If filled, Debtor BIC must be a published SWIFT BIC Remark:
31	A42	A042	Error Text: Creditor BIC is not a published SWIFT BIC Validation: If filled, Creditor BIC must be a published SWIFT BIC Remark:
32	A70	A070	Error Text: Counterpart AS does not contain a valid AS BIC in relation with the sender. Validation: If the PaymentSchemeCode is "CDS", <BIC> in <CtpAS> is mandatory and should contain a valid AS BIC with which the

Order	Error code				Error Text / Validation/ Remark
	SSP	Y-copy	V-shape	XML	

sending AS is in relation.

Remark:

33	A71		A071	<p>Error Text: Counterpart AS forbidden for transactions other than cross-AS settlement.</p> <p>Validation: If the PaymentSchemeCode is not "CDS", <BIC> in <CtpAS> is forbidden.</p> <p>Remark:</p>
34	A72		A072	<p>Error Text: Debtor BIC is not a Settlement Bank linked to the real-time AS sender of cross-AS settlement.</p> <p>Validation: For Model 6 code "CDS": If the FirstAgent is a Technical account - procedure 6 real-time, the <BIC> in <Dbtr><FI> is mandatory.</p> <p>Remark:</p>
35	A73		A073	<p>Error Text: Creditor BIC is not a Settlement Bank linked to the real-time AS receiver of cross-AS settlement.</p> <p>Validation: For Model 6 code "CDS": If the FinalAgent is a Technical account - procedure 6 real-time, the <BIC> in <Cdtr><FI> is mandatory.</p> <p>Remark:</p>
36	A43		A043	<p>Error Text: Number of transactions too high.</p> <p>Validation: For Model 3: If the AS opted for single notification the number of transactions must not exceed 3000.</p> <p>Remark:</p>

ASTransferInitiation_1

Scope: This sample of ASTransferInitiation is sent by an AS or a CB on its behalf to debit the Technical account - procedure 6 real-time of the AS and credit a Settlement bank in the framework of Model 1

-----Addressing validations rules-----

Sender= BIC of the AS or BIC of the CB on behalf of the AS
FirstAgent = BIC of the Technical account - procedure 6 real-time of the AS
FinalAgent = BIC of a Settlement Bank
Option :
Debtor : if present, it will be copied in MT202 field 52A (BIC + Domestic account)
Creditor : if present, it will be copied in MT202 field 58A (BIC+ Domestic account)

Message Type	<pain.998.001.01>
Proprietary Data	<PrtryDt>
Proprietary Data type	<Tp>ASTransferInitiation</Tp>
SSP Proprietary Data	<SspPrtryDt>
GroupHeader	<GrpHdr>
GroupIdentification	<GrpId>ABC1234</GrpId>
CreationDateTime	<CreDtTm>2007-07-01T11:25:00</CreDtTm>
ControlSum	<CtrlSum>12345678.90</CtrlSum>
NumberOfTransactions	<NbOfTxs>1</NbOfTxs>
Priority	<Prty>HIGH</Prty>
SettlementModelType	<SttlmMdlTp>1000</SttlmMdlTp>
InitiatingParty	<InitgPty>
Financial institution	<FI>
BIC	<BIC>INNDNL2UXXX</BIC>
End of financial institution	</FI>
EndInitiatingParty	</InitgPty>
EndGroupHeader	</GrpHdr>
PaymentInformation	<PmtInf>
RequestedExecutionDate	<ReqdExctnDt>2007-07-01</ReqdExctnDt>
Debtor	<Dbtr>
Name of the account. An additional identification	<Nm>ABC1234</Nm>
Financial institution	<FI>
BIC	<BIC>AAAAGRPPXXX</BIC>
End of financial institution	</FI>
End of debtor	</Dbtr>
DebtorAccount	<DbtrAcct>
Simple Identification Information	<DmstAcct>
Identification	<Id>ABC1234</Id>
End of simple Identification Information	</DmstAcct>
EndDebtorAccount	</DbtrAcct>
First Agent	<FrstAgt>
BIC	<BIC>INNDNL2UMIR</BIC>
End First Agent	</FrstAgt>
Information payment transaction.	<PmtTx>
PaymentIdentification	<PmtId>
InstructionIdentification	<InstrId>ABC1234</InstrId>
EndToEndIdentification	<EndToEndId>ABC1234</EndToEndId>
EndPaymentIdentification	</PmtId>
Amount	<Amt>
InstructedAmount	<InstAmt>12345678.90</InstAmt>
End of Amount	</Amt>
Creditor	<Cdtr>
Name	<Nm>ABC1234</Nm>

Financial institution					<FI>
BIC					<BIC>BANKFRPPXXX</BIC>
End of financial institution					</FI>
End of Creditor					</Cdtr>
CreditorAccount					<CdtrAcct>
Simple Identification Information					<DmstAcct>
Identification					<Id>FR98765CC01</Id>
End of simple Identification Information					</DmstAcct>
EndCreditorAccount					</CdtrAcct>
Final Agent					<FnIAgt>
BIC					<BIC>CREDFRPPXXX</BIC>
End of Final Agent					</FnIAgt>
RemittanceInformation					<RmtInf>
Unstructured					<Ustrd>ABC1234</Ustrd>
EndRemittanceInformation					</RmtInf>
End of Information payment transaction.					</PmtTx>
EndPaymentInformation					</PmtInf>
End of SSP Proprietary Data					</SspPrtryDt>
End of Proprietary Data					</PrtryDt>
End Message Type					</pain.998.001.01>

ASTransferInitiation_2

Scope: This message is sent by the AS or a CB on its behalf in the framework of Model 2 to debit a Settlement bank and to credit the same or another one, or to perform a transaction between the AS technical account and the account of a Settlement Bank.

-----Addressing validations rules-----

Sender= BIC of the AS or BIC of the CB on behalf of the AS

Case 1: FirstAgent = BIC of a Settlement Bank, FinalAgent = BIC of a Settlement Bank

Case 2: FirstAgent = BIC of a Settlement Bank, FinalAgent = BIC of a Technical Account

Case 3: FirstAgent = BIC of a Technical Account, FinalAgent = BIC of a Settlement Bank

Option : The AS participants (BIC, name, account number) which are credited or debited in the SSS may be indicated in the elements "Creditor" and "Debtor". The "Debtor" elements will be mapped to field 72 of the MT900.

The "Creditor" elements will be mapped to field 72 of the MT910.

The contents of field "Ustrd" will be mapped to field 72 of the MT900/910.

Message Type	<pain.998.001.01>
Proprietary Data	<PrtryDt>
Proprietary Data type	<Tp>ASTransferInitiation</Tp>
SSP Proprietary Data	<SspPrtryDt>
GroupHeader	<GrpHdr>
GroupIdentification	<Grpld>ABC1234</Grpld>
CreationDateTime	<CreDtTm>2007-07-01T11:25:00</CreDtTm>
ControlSum	<CtrlSum>12345678.90</CtrlSum>
NumberOfTransactions	<NbOfTxs>1</NbOfTxs>
Priority	<Prty>HIGH</Prty>
SettlementModelType	<SttlmMdlTp>2000</SttlmMdlTp>
ScheduledTime	<SchldTm>
InformationPeriodType	<InfPrdTp>INFO</InfPrdTp>
FromTime	<FrTm>12:00:00</FrTm>
EndScheduledTime	</SchldTm>
SettlementPeriodType	<SttlmPrdTp>
Duration	<TmPrd>00:30:00</TmPrd>
EndSettlementPeriodType	</SttlmPrdTp>
InitiatingParty	<InitgPty>
Financial institution	<FI>
BIC	<BIC>ANCILU2LXXX</BIC>
End of financial institution	</FI>
EndInitiatingParty	</InitgPty>
EndGroupHeader	</GrpHdr>
PaymentInformation	<PmtInf>
RequestedExecutionDate	<ReqdExctnDt>2007-07-01</ReqdExctnDt>
Debtor	<Dbtr>
Name of the account. An additional identification	<Nm>ABC1234</Nm>
Financial institution	<FI>
BIC	<BIC>AAAAGRPPXXX</BIC>
End of financial institution	</FI>
End of debtor	</Dbtr>
DebtorAccount	<DbtrAcct>
Simple Identification Information	<DmstAcct>
Identification	<Id>ABC1234</Id>
End of simple Identification Information	</DmstAcct>
EndDebtorAccount	</DbtrAcct>
First Agent	<FrstAgt>
BIC	<BIC>BBBBGRAAXX</BIC>
End First Agent	</FrstAgt>
Information payment transaction.	<PmtTx>

PaymentIdentification	<PmtId>
InstructionIdentification	<InstrId>ABC1234</InstrId>
EndToEndIdentification	<EndToEndId>ABC1234</EndToEndId>
EndPaymentIdentification	</PmtId>
Amount	<Amt>
InstructedAmount	<InstAmt>12345678.90</InstAmt>
End of Amount	</Amt>
Creditor	<Cdtr>
Name	<Nm>ABC1234</Nm>
Financial institution	<FI>
BIC	<BIC>BANKFRPPXXX</BIC>
End of financial institution	</FI>
End of Creditor	</Cdtr>
CreditorAccount	<CdtrAcct>
Simple Identification Information	<DmstAcct>
Identification	<Id>FR98765CC01</Id>
End of simple Identification Information	</DmstAcct>
EndCreditorAccount	</CdtrAcct>
Final Agent	<FnIAgt>
BIC	<BIC>BANCIT21XXX</BIC>
End of Final Agent	</FnIAgt>
RemittanceInformation	<RmtInf>
Unstructured	<Ustrd>ABC1234</Ustrd>
EndRemittanceInformation	</RmtInf>
End of Information payment transaction.	</PmtTx>
EndPaymentInformation	</PmtInf>
End of SSP Proprietary Data	</SspPrtryDt>
End of Proprietary Data	</PrtryDt>
End Message Type	</pain.998.001.01>

ASTransferInitiation_2b

Scope: This message is sent by the AS or a CB on its behalf in the framework of Model 2 to debit a Settlement bank and to credit the AS technical account.

-----Addressing validations rules-----

Sender= DN of the AS or DN of the CB on behalf of the AS

Case 1: FirstAgent = BIC of a Settlement Bank, FinalAgent = BIC of a Settlement Bank

Case 2: FirstAgent = BIC of a Settlement Bank, FinalAgent = BIC of a Technical Account

Case 3: FirstAgent = BIC of a Technical Account, FinalAgent = BIC of a Settlement Bank

Option : The AS participants (BIC, name, account number) which are credited or debited in the SSS may be indicated in the elements "Creditor" and "Debtor". The "Debtor" elements will be mapped to field 72 of the MT900.

The "Creditor" elements will be mapped to field 72 of the MT910.

The contents of field "Ustrd" will be mapped to field 72 of the MT900/910.

Message Type	<pain.998.001.01>
Proprietary Data	<PrtryDt>
Proprietary Data type	<Tp>ASTransferInitiation</Tp>
SSP Proprietary Data	<SspPrtryDt>
GroupHeader	<GrpHdr>
GroupIdentification	<Grpld>ABC1234</Grpld>
CreationDateTime	<CreDtTm>2007-07-01T11:25:00</CreDtTm>
ControlSum	<CtrlSum>12345678.90</CtrlSum>
NumberOfTransactions	<NbOfTxs>1</NbOfTxs>
Priority	<Prty>HIGH</Prty>
SettlementModelType	<SttlmMdlTp>2000</SttlmMdlTp>
ScheduledTime	<SchldTm>
InformationPeriodType	<InfPrdTp>INFO</InfPrdTp>
FromTime	<FrTm>12:00:00</FrTm>
EndScheduledTime	</SchldTm>
SettlementPeriodType	<SttlmPrdTp>
Duration	<TmPrd>00:30:00</TmPrd>
EndSettlementPeriodType	</SttlmPrdTp>
InitiatingParty	<InitgPty>
Financial institution	<FI>
BIC	<BIC>ANCILU2LXXX</BIC>
End of financial institution	</FI>
EndInitiatingParty	</InitgPty>
EndGroupHeader	</GrpHdr>
PaymentInformation	<PmtInf>
RequestedExecutionDate	<ReqdExctnDt>2007-07-01</ReqdExctnDt>
Debtor	<Dbtr>
Name of the account. An additional identification	<Nm>ABC1234</Nm>
Financial institution	<FI>
BIC	<BIC>AAAAGRPPXXX</BIC>
End of financial institution	</FI>
End of debtor	</Dbtr>
DebtorAccount	<DbtrAcct>
Simple Identification Information	<DmstAcct>
Identification	<Id>ABC1234</Id>
End of simple Identification Information	</DmstAcct>
EndDebtorAccount	</DbtrAcct>
First Agent	<FrstAgt>
BIC	<BIC>BBBBGRAAXX</BIC>
End First Agent	</FrstAgt>
Information payment transaction.	<PmtTx>
PaymentIdentification	<PmtId>
InstructionIdentification	<InstrId>ABC1234</InstrId>

EndToEndIdentification		<EndToEndId>ABC1234</EndToEndId>
EndPaymentIdentification		</PmtId>
Amount		<Amt>
InstructedAmount		<InstAmt>12345678.90</InstAmt>
End of Amount		</Amt>
Final Agent		<FnlAgt>
BIC		<BIC>ANCILU2LTEC</BIC>
End of Final Agent		</FnlAgt>
RemittanceInformation		<RmtInf>
Unstructured		<Ustrd>ABC1234</Ustrd>
EndRemittanceInformation		</RmtInf>
End of Information payment transaction.		</PmtTx>
EndPaymentInformation		</PmtInf>
End of SSP Proprietary Data		</SspPrtryDt>
End of Proprietary Data		</PrtryDt>
End Message Type		</pain.998.001.01>

ASTransferInitiation_3

Scope: This message is sent by the AS or the CB on its behalf to debit / credit a collection of transactions in the framework of Models 3, 4 and 5,

-----Addressing validations rules-----

Sender= BIC of the AS or BIC of the CB on behalf of the AS

Case 1: FirstAgent= BIC of a Settlement Bank, FinalAgent =BIC of a Technical Account

Case 2: FirstAgent= BIC of a Technical Account, FinalAgent = BIC of a Settlement Bank

Case 3: FirstAgent = BIC of a Settlement Bank, FinalAgent = BIC of a Settlement Bank (Model 3 only)

Option : The AS participants (BIC, name, account number) which are credited or debited in the SSS may be indicated in the elements "Creditor" and "Debtor". The "Debtor" elements will be mapped to field 72 of the MT900.

The "Creditor" elements will be mapped to field 72 of the MT910.

The contents of field "Ustrd" will be mapped to field 72 of the MT900/910.

Message Type	<pain.998.001.01>
Proprietary Data	<PrtryDt>
Proprietary Data type	<Tp>ASTransferInitiation</Tp>
SSP Proprietary Data	<SspPrtryDt>
GroupHeader	<GrpHdr>
GroupIdentification	<Grpld>ABC1234</Grpld>
CreationDateTime	<CreDtTm>2007-07-01T11:25:00</CreDtTm>
ControlSum	<CtrlSum>1000.00</CtrlSum>
NumberOfTransactions	<NbOfTxs>2</NbOfTxs>
Priority	<Prty>HIGH</Prty>
SettlementModelType	<SttlmMdlTp>4000</SttlmMdlTp>
ScheduledTime	<SchldTm>
InformationPeriodType	<InfPrdTp>AGRE</InfPrdTp>
FromTime	<FrTm>12:00:00</FrTm>
EndScheduledTime	</SchldTm>
SettlementPeriodType	<SttlmPrdTp>
Duration	<TmPrd>00:30:00</TmPrd>
EndSettlementPeriodType	</SttlmPrdTp>
InitiatingParty	<InitgPty>
Financial institution	<FI>
BIC	<BIC>ANCILU2LXXX</BIC>
End of financial institution	</FI>
EndInitiatingParty	</InitgPty>
EndGroupHeader	</GrpHdr>
PaymentInformation	<PmtInf>
RequestedExecutionDate	<ReqdExctnDt>2007-07-01</ReqdExctnDt>
First Agent	<FrstAgt>
BIC	<BIC>ANCILU2LTEC</BIC>
End First Agent	</FrstAgt>
Information payment transaction.	<PmtTx>
PaymentIdentification	<PmtId>
InstructionIdentification	<InstrId>ABC1234</InstrId>
EndToEndIdentification	<EndToEndId>ABC1234</EndToEndId>
EndPaymentIdentification	</PmtId>
Amount	<Amt>
InstructedAmount	<InstAmt>500.00</InstAmt>
End of Amount	</Amt>
Final Agent	<FnlAgt>
BIC	<BIC>CREDFRPPXXX</BIC>
End of Final Agent	</FnlAgt>
RemittanceInformation	<RmtInf>

Unstructured	<Ustrd>ABC1234</Ustrd>
EndRemittanceInformation	</RmtInf>
End of Information payment transaction.	</PmtTx>
EndPaymentInformation	</PmtInf>
PaymentInformation	<PmtInf>
RequestedExecutionDate	<ReqdExctnDt>2007-07-01</ReqdExctnDt>
First Agent	<FrstAgt>
BIC	<BIC>KREDDEFFXX</BIC>
End First Agent	</FrstAgt>
Information payment transaction.	<PmtTx>
PaymentIdentification	<PmtId>
InstructionIdentification	<InstrId>XYZ9876</InstrId>
EndToEndIdentification	<EndToEndId>ZYX9876</EndToEndId>
EndPaymentIdentification	</PmtId>
Amount	<Amt>
InstructedAmount	<InstAmt>500.00</InstAmt>
End of Amount	</Amt>
Final Agent	<FnlAgt>
BIC	<BIC>ANCILU2LTEC</BIC>
End of Final Agent	</FnlAgt>
RemittanceInformation	<RmtInf>
Unstructured	<Ustrd>ABC1234</Ustrd>
EndRemittanceInformation	</RmtInf>
End of Information payment transaction.	</PmtTx>
EndPaymentInformation	</PmtInf>
End of SSP Proprietary Data	</SspPrtryDt>
End of Proprietary Data	</PrtryDt>
End Message Type	</pain.998.001.01>

ASTransferInitiation_3b

Scope: This message is sent with model 3 by the CB on behalf of an AS real-time model to debit/credit a Settlement Bank against a Technical account - procedure 6 real-time.

-----Addressing validations rules-----

Sender= DN of the AS or DN of the CB on behalf of the AS

Case 1: FirstAgent= BIC of a Settlement Bank, FinalAgent =BIC of a Technical Account (or Technical account - procedure 6 real-time)

Case 2: FirstAgent= BIC of a Technical Account (mirror account), FinalAgent = BIC of a Settlement Bank

Case 3: FirstAgent = BIC of a Settlement Bank, FinalAgent = BIC of a Settlement Bank (Model 2 or Model 3)

Option : The AS participants (BIC, name, account number) which are credited or debited in the SSS may be indicated in the elements "Creditor" and "Debtor". The "Debtor" elements will be mapped to field 72 of the MT900.

The "Creditor" elements will be mapped to field 72 of the MT910.

The contents of field "Ustrd" will be mapped to field 72 of the MT900/910.

Message Type	<pain.998.001.01>
Proprietary Data	<PrtryDt>
Proprietary Data type	<Tp>ASTransferInitiation</Tp>
SSP Proprietary Data	<SspPrtryDt>
GroupHeader	<GrpHdr>
GroupIdentification	<GrpId>ABC1234</GrpId>
CreationDateTime	<CreDtTm>2007-07-01T11:25:00</CreDtTm>
ControlSum	<CtrlSum>1000.00</CtrlSum>
NumberOfTransactions	<NbOfTxs>2</NbOfTxs>
Priority	<Prty>HIGH</Prty>
SettlementModelType	<SttlmMdlTp>3000</SttlmMdlTp>
ScheduledTime	<SchdldTm>
InformationPeriodType	<InfPrdTp>AGRE</InfPrdTp>
FromTime	<FrTm>12:00:00</FrTm>
EndScheduledTime	</SchdldTm>
SettlementPeriodType	<SttlmPrdTp>
Duration	<TmPrd>00:30:00</TmPrd>
EndSettlementPeriodType	</SttlmPrdTp>
InitiatingParty	<InitgPty>
Financial institution	<FI>
BIC	<BIC>ANCILU2LXXX</BIC>
End of financial institution	</FI>
EndInitiatingParty	</InitgPty>
EndGroupHeader	</GrpHdr>
PaymentInformation	<PmtInf>
RequestedExecutionDate	<ReqdExctnDt>2007-07-01</ReqdExctnDt>
First Agent	<FrstAgt>
BIC	<BIC>ANCILU2LMIR</BIC>
End First Agent	</FrstAgt>
Information payment transaction.	<PmtTx>
PaymentIdentification	<PmtId>
InstructionIdentification	<InstrId>ABC1234</InstrId>
EndToEndIdentification	<EndToEndId>ABC1234</EndToEndId>
EndPaymentIdentification	</PmtId>
Amount	<Amt>
InstructedAmount	<InstAmt>500.00</InstAmt>
End of Amount	</Amt>
Final Agent	<FnIAgt>
BIC	<BIC>CREDFRPPXXX</BIC>
End of Final Agent	</FnIAgt>
RemittanceInformation	<RmtInf>

Unstructured	<Ustrd>ABC1234</Ustrd>
EndRemittanceInformation	</RmtInf>
End of Information payment transaction.	</PmtTx>
EndPaymentInformation	</PmtInf>
PaymentInformation	<PmtInf>
RequestedExecutionDate	<ReqdExctnDt>2007-07-01</ReqdExctnDt>
First Agent	<FrstAgt>
BIC	<BIC>KREDDEFFXX</BIC>
End First Agent	</FrstAgt>
Information payment transaction.	<PmtTx>
PaymentIdentification	<PmtId>
InstructionIdentification	<InstrId>XYZ9876</InstrId>
EndToEndIdentification	<EndToEndId>ZYX9876</EndToEndId>
EndPaymentIdentification	</PmtId>
Amount	<Amt>
InstructedAmount	<InstAmt>500.00</InstAmt>
End of Amount	</Amt>
Final Agent	<FnlAgt>
BIC	<BIC>ANCILU2LMIR</BIC>
End of Final Agent	</FnlAgt>
RemittanceInformation	<RmtInf>
Unstructured	<Ustrd>ABC1234</Ustrd>
EndRemittanceInformation	</RmtInf>
End of Information payment transaction.	</PmtTx>
EndPaymentInformation	</PmtInf>
End of SSP Proprietary Data	</SspPrtryDt>
End of Proprietary Data	</PrtryDt>
End Message Type	</pain.998.001.01>

ASTransferInitiation_3c

Scope: This message is sent with model 4 by the AS (or the CB on behalf) to debit/credit a Settlement Bank against a Technical Account.

-----Addressing validations rules-----

Sender= DN of the AS or DN of the CB on behalf of the AS

Case 1: FirstAgent= BIC of a Settlement Bank, FinalAgent =BIC of a Technical Account

Case 2: FirstAgent= BIC of a Technical Account , FinalAgent = BIC of a Settlement Bank

Option : The AS participants (BIC, name, account number) which are credited or debited in the SSS may be indicated in the elements "Creditor" and "Debtor". The "Debtor" elements will be mapped to field 72 of the MT900.

The "Creditor" elements will be mapped to field 72 of the MT910.

The contents of field "Ustrd" will be mapped to field 72 of the MT900/910.

Message Type	<pain.998.001.01>
Proprietary Data	<PrtryDt>
Proprietary Data type	<Tp>ASTransferInitiation</Tp>
SSP Proprietary Data	<SspPrtryDt>
GroupHeader	<GrpHdr>
GroupIdentification	<Grpld>ABC1234</Grpld>
CreationDateTime	<CreDtTm>2007-07-01T11:25:00</CreDtTm>
ControlSum	<CtrlSum>2000.00</CtrlSum>
NumberOfTransactions	<NbOfTxs>3</NbOfTxs>
Priority	<Prty>HIGH</Prty>
SettlementModelType	<StlmMdlTp>4000</StlmMdlTp>
ScheduledTime	<SchldTm>
InformationPeriodType	<InfPrdTp>AGRE</InfPrdTp>
FromTime	<FrTm>12:00:00</FrTm>
EndScheduledTime	</SchldTm>
SettlementPeriodType	<StlmPrdTp>
Duration	<TmPrd>00:30:00</TmPrd>
EndSettlementPeriodType	</StlmPrdTp>
EndGroupHeader	</GrpHdr>
PaymentInformation	<PmtInf>
RequestedExecutionDate	<ReqdExctnDt>2007-07-01</ReqdExctnDt>
First Agent	<FrstAgt>
BIC	<BIC>ANCILU2LTEC</BIC>
End First Agent	</FrstAgt>
Information payment transaction.	<PmtTx>
PaymentIdentification	<PmtId>
InstructionIdentification	<InstrId>ABC1234</InstrId>
EndToEndIdentification	<EndToEndId>ABC1234</EndToEndId>
EndPaymentIdentification	</PmtId>
Amount	<Amt>
InstructedAmount	<InstAmt>500.00</InstAmt>
End of Amount	</Amt>
Final Agent	<FnIAgt>
BIC	<BIC>CREFRPPXXX</BIC>
End of Final Agent	</FnIAgt>
RemittanceInformation	<RmtInf>
Unstructured	<Ustrd>ABC1234</Ustrd>
EndRemittanceInformation	</RmtInf>
End of Information payment transaction.	</PmtTx>
EndPaymentInformation	</PmtInf>
PaymentInformation	<PmtInf>
RequestedExecutionDate	<ReqdExctnDt>2007-07-01</ReqdExctnDt>

First Agent	<FrstAgt>
BIC	<BIC>ANCILU2LTEC</BIC>
End First Agent	</FrstAgt>
Information payment transaction.	<PmtTx>
PaymentIdentification	<PmtId>
InstructionIdentification	<InstrId>XYZ9876</InstrId>
EndToEndIdentification	<EndToEndId>ZYX9876</EndToEndId>
EndPaymentIdentification	</PmtId>
Amount	<Amt>
InstructedAmount	<InstAmt>500.00</InstAmt>
End of Amount	</Amt>
Final Agent	<FnIAgt>
BIC	<BIC>KREDEFFXXX</BIC>
End of Final Agent	</FnIAgt>
RemittanceInformation	<RmtInf>
Unstructured	<Ustrd>ABC1234</Ustrd>
EndRemittanceInformation	</RmtInf>
End of Information payment transaction.	</PmtTx>
EndPaymentInformation	</PmtInf>
PaymentInformation	<PmtInf>
RequestedExecutionDate	<ReqdExctnDt>2007-07-01</ReqdExctnDt>
First Agent	<FrstAgt>
BIC	<BIC>DEBTLU2L123</BIC>
End First Agent	</FrstAgt>
Information payment transaction.	<PmtTx>
PaymentIdentification	<PmtId>
InstructionIdentification	<InstrId>1A2B3C</InstrId>
EndToEndIdentification	<EndToEndId>3C2B1A</EndToEndId>
EndPaymentIdentification	</PmtId>
Amount	<Amt>
InstructedAmount	<InstAmt>1000.00</InstAmt>
End of Amount	</Amt>
Final Agent	<FnIAgt>
BIC	<BIC>ANCILU2LTEC</BIC>
End of Final Agent	</FnIAgt>
RemittanceInformation	<RmtInf>
Unstructured	<Ustrd>ABC1234</Ustrd>
EndRemittanceInformation	</RmtInf>
End of Information payment transaction.	</PmtTx>
EndPaymentInformation	</PmtInf>
End of SSP Proprietary Data	</SspPrtryDt>
End of Proprietary Data	</PrtryDt>
End Message Type	</pain.998.001.01>

ASTransferInitiation_3d

Scope: This message is sent with model 5 by the CB on behalf of the AS to debit/credit a Settlement Bank against a Technical Account.
The schedule time and the settlement period time are both expressed in duration (time period)

-----Addressing validations rules-----

Sender= DN of the AS or DN of the CB on behalf of the AS

Case 1: FirstAgent= BIC of a Settlement Bank, FinalAgent =BIC of a Technical Account

Case 2: FirstAgent= BIC of a Technical Account , FinalAgent = BIC of a Settlement Bank

Option : The AS participants (BIC, name, account number) which are credited or debited in the SSS may be indicated in the elements "Creditor" and "Debtor". The "Debtor" elements will be mapped to field 72 of the MT900.

The "Creditor" elements will be mapped to field 72 of the MT910.

The contents of field "Ustrd" will be mapped to field 72 of the MT900/910.

Message Type	<pain.998.001.01>
Proprietary Data	<PrtryDt>
Proprietary Data type	<Tp>ASTransferInitiation</Tp>
SSP Proprietary Data	<SspPrtryDt>
GroupHeader	<GrpHdr>
GroupIdentification	<Grpld>ABC1234</Grpld>
CreationDateTime	<CreDtTm>2007-07-01T11:25:00</CreDtTm>
ControlSum	<CtrlSum>2000.00</CtrlSum>
NumberOfTransactions	<NbOfTxs>3</NbOfTxs>
Priority	<Prty>HIGH</Prty>
SettlementModelType	<SttlmMdlTp>5000</SttlmMdlTp>
ScheduledTime	<SchldTm>
InformationPeriodType	<InfPrdTp>AGRE</InfPrdTp>
Duration	<TmPrd>00:30:00</TmPrd>
EndScheduledTime	</SchldTm>
SettlementPeriodType	<SttlmPrdTp>
Duration	<Tmprd>00:30:00</Tmprd>
EndSettlementPeriodType	</SttlmPrdTp>
InitiatingParty	<InitgPty>
Financial institution	<FI>
BIC	<BIC>ANCILU2LXXX</BIC>
End of financial institution	</FI>
EndInitiatingParty	</InitgPty>
EndGroupHeader	</GrpHdr>
PaymentInformation	<PmtInf>
RequestedExecutionDate	<ReqdExctnDt>2007-07-01</ReqdExctnDt>
First Agent	<FrstAgt>
BIC	<BIC>ANCILU2LTEC</BIC>
End First Agent	</FrstAgt>
Information payment transaction.	<PmtTx>
PaymentIdentification	<PmtId>
InstructionIdentification	<InstrId>ABC1234</InstrId>
EndToEndIdentification	<EndToEndId>ABC1234</EndToEndId>
EndPaymentIdentification	</PmtId>
Amount	<Amt>
InstructedAmount	<InstAmt>500.00</InstAmt>
End of Amount	</Amt>
Final Agent	<FnAgt>
BIC	<BIC>CREFRPPXXX</BIC>
End of Final Agent	</FnAgt>
RemittanceInformation	<RmtInf>

Unstructured	<Ustrd>ABC1234</Ustrd>
EndRemittanceInformation	</RmtInf>
End of Information payment transaction.	</PmtTx>
EndPaymentInformation	</PmtInf>
PaymentInformation	<PmtInf>
RequestedExecutionDate	<ReqdExctnDt>2007-07-01</ReqdExctnDt>
First Agent	<FrstAgt>
BIC	<BIC>ANCILU2LTEC</BIC>
End First Agent	</FrstAgt>
Information payment transaction.	<PmtTx>
PaymentIdentification	<PmtId>
InstructionIdentification	<InstrId>XYZ9876</InstrId>
EndToEndIdentification	<EndToEndId>ZYX9876</EndToEndId>
EndPaymentIdentification	</PmtId>
Amount	<Amt>
InstructedAmount	<InstAmt>500.00</InstAmt>
End of Amount	</Amt>
Final Agent	<FnIAgt>
BIC	<BIC>KREDEFFXXX</BIC>
End of Final Agent	</FnIAgt>
RemittanceInformation	<RmtInf>
Unstructured	<Ustrd>ABC1234</Ustrd>
EndRemittanceInformation	</RmtInf>
End of Information payment transaction.	</PmtTx>
EndPaymentInformation	</PmtInf>
PaymentInformation	<PmtInf>
RequestedExecutionDate	<ReqdExctnDt>2007-07-01</ReqdExctnDt>
First Agent	<FrstAgt>
BIC	<BIC>DEBTLU2L123</BIC>
End First Agent	</FrstAgt>
Information payment transaction.	<PmtTx>
PaymentIdentification	<PmtId>
InstructionIdentification	<InstrId>1A2B3C</InstrId>
EndToEndIdentification	<EndToEndId>3C2B1A</EndToEndId>
EndPaymentIdentification	</PmtId>
Amount	<Amt>
InstructedAmount	<InstAmt>1000.00</InstAmt>
End of Amount	</Amt>
Final Agent	<FnIAgt>
BIC	<BIC>ANCILU2LTEC</BIC>
End of Final Agent	</FnIAgt>
RemittanceInformation	<RmtInf>
Unstructured	<Ustrd>ABC1234</Ustrd>
EndRemittanceInformation	</RmtInf>
End of Information payment transaction.	</PmtTx>
EndPaymentInformation	</PmtInf>
End of SSP Proprietary Data	</SspPrtryDt>
End of Proprietary Data	</PrtryDt>
End Message Type	</pain.998.001.01>

ASTransferInitiation_4

Scope: This sample of message is sent by the AS, the CB on ist behalf or a CB (in the case of connected payments) in the framework of Model 6.

-----Addressing validations rules-----

For Model 6, the Payment scheme code is a criterion for the addressing validation rules.
All the payments contained in the file must have the same Payment scheme code.

*If code = SET (Settlement)

.Sender= DN of the AS or DN of the CB on behalf of the AS

Case 1: FirstAgent = BIC of a Settlement Bank, DomesticAccount = Sub-account, FinalAgent = BIC of a Technical Account

Case 2: FirstAgent = BIC of a Technical Account, FinalAgent = BIC of a Settlement Bank, DomesticAccount = Sub-account or empty (for Main Account)

*If code = CUO (Current Order)

.Sender= DN of the AS or DN of the CB on behalf of the AS

Case 1: FirstAgent = BIC of a Settlement Bank, FinalAgent = BIC of the Technical account - procedure 6 real-time

Case 2: FirstAgent = BIC of the Technical account - procedure 6 real-time, FinalAgent = BIC of a Settlement Bank

Case 3: FirstAgent = BIC of a Settlement Bank, FinalAgent = BIC of the Settlement Bank, DomesticAccount = Sub-account

Case 4: FirstAgent = BIC of a Settlement Bank, DomesticAccount = Sub-account, FinalAgent = BIC of the Settlement Bank

*If code = CSP (Connected payments on SSP accounts)

.Sender = DN of the AS or DN of the CB on behalf of the AS

Case 1: FirstAgent = BIC of a Settlement Bank(with same Home CB as the AS), FinalAgent = BIC of the Settlement Bank, DomesticAccount = Sub-account

.Sender = DN of the CB on behalf of the AS

Case 2: FirstAgent = BIC of a Settlement Bank, DomesticAccount = Sub-account, FinalAgent = BIC of the Settlement Bank (with same Home CB as the AS)

Sender = DN of the CB

*If code = CHA (Increase/decrease of liquidity with credit lines managed in proprietary home account) or REP (Increase/decrease of blocked liquidity by auto-collateralisation for repo countries)

.Sender = DN of the AS

Case 1: FirstAgent = BIC of the main CB account (home CB of the AS) FinalAgent = BIC of the Settlement Bank (with same Home CB as the AS), DomesticAccount = Sub-account

.Sender = DN of the CB (Home CB of the AS)

Case2: FirstAgent = BIC of a Settlement Bank (with same Home CB as the AS), DomesticAccount = Sub-account FinalAgent = BIC of the CB Main account

Case 3: FirstAgent = BIC of the CB main account FinalAgent = BIC of the Settlement Bank (with same Home CB as the AS), DomesticAccount = Sub-account

*If code = COL (Debit (credit) auto-collateral Mirror account)

.Sender= DN of the AS or DN of the CB on behalf of the AS

Case 1: FirstAgent = BIC of the Auto-collateral mirror account (with same Home CB as the AS), FinalAgent = BIC of the Settlement Bank (with same Home CB as the AS), DomesticAccount= Sub-account

.Sender = DN of the CB on behalf of the AS

Case 2: FirstAgent = BIC of the Settlement Bank (with same Home CB as the AS), DomesticAccount = Sub-account, FinalAgent = BIC of the Auto-collateral mirror account (with same Home CB as the AS)

*If code = STR (Increase of liquidity by specific transactions)

Sender = DN of the AS or DN of the CB on behalf of the AS

FirstAgent = BIC of the Technical Account, FinalAgent = BIC of the Settlement Bank, DomesticAccount = Sub-account or empty (for Main Account)

*If code = CDS (Cross-AS settlement)

Case 1: Sender = DN of an Interfaced AS1 (or DN of the CB on behalf of AS1)

Counterpart AS = BIC of an Interfaced AS2

FirstAgent = BIC of a settlement Bank in AS1, DomesticAccount = Sub-account number

FinalAgent = BIC of a settlement Bank in AS2, DomesticAccount = Sub-account number

Case 2: Sender = DN of an Interfaced AS1 (or DN of the CB on behalf of AS1)

Counterpart AS = BIC of a real-time AS2

FirstAgent = BIC of a settlement Bank in AS1, DomesticAccount = Sub-account number

FinalAgent = BIC of the Technical account - procedure 6 real-time of AS2, Creditor = BIC of a Settlement Bank in AS2

Case 3: Sender = DN of a real-time AS1 (or DN of the CB on behalf of AS1)

Counterpart AS = BIC of an Interfaced AS2

FirstAgent = BIC of the Technical account - procedure 6 real-time of AS1, Debtor = BIC of a Settlement Bank in AS1

FinalAgent = BIC of a settlement Bank in AS2, DomesticAccount = Sub-account number

Case 4: Sender = DN of a real-time AS1 (or DN of the CB on behalf of AS1)

Counterpart AS = BIC of a real-time AS2

FirstAgent = BIC of the Technical account - procedure 6 real-time of AS1, Debtor = BIC of a Settlement Bank in AS1

FinalAgent = BIC of the Technical account - procedure 6 real-time of AS2, Creditor = BIC of a Settlement Bank in AS2

Message Type	<pain.998.001.01>
Proprietary Data	<PrtryDt>
Proprietary Data type	<Tp>ASTransferInitiation</Tp>
SSP Proprietary Data	<SspPrtryDt>
GroupHeader	<GrpHdr>
GroupIdentification	<Grpld>ABC1234</Grpld>
CreationDateTime	<CreDtTm>2007-01-01T11:30:00</CreDtTm>
ControlSum	<CtrlSum>12345678.90</CtrlSum>
NumberOfTransactions	<NbOfTxs>1</NbOfTxs>
Priority	<Prty>HIGH</Prty>
SettlementModelType	<SttlmMdlTp>6000</SttlmMdlTp>
InitiatingParty	<InitgPty>
Financial institution	<FI>
BIC	<BIC>ANCIATWWXXX</BIC>
End of financial institution	</FI>
EndInitiatingParty	</InitgPty>
EndGroupHeader	</GrpHdr>
PaymentInformation	<PmtInf>
RequestedExecutionDate	<ReqdExctnDt>2007-01-01</ReqdExctnDt>
CreditTransferTypeIdentification	<CdtTrfTpId>
SettlementPriorityChoice	<SttlmPrty>
PaymentScheme	<PmtSchme>
Code	<Cd>CSP</Cd>
EndPaymentScheme	</PmtSchme>
EndSettlementPriorityChoice	</SttlmPrty>
EndCreditTransferTypeIdentification	</CdtTrfTpId>
First Agent	<FrstAgt>
BIC	<BIC>BANKATWWXXX</BIC>
End First Agent	</FrstAgt>
FirstAgentAccount	<FrstAgtAcct>
Simple Identification Information	<DmstAcct>
Identification	<Id>AT12345SUBACC01</Id>
End of simple Identification Information	</DmstAcct>
EndFirstAgentAccount	</FrstAgtAcct>
Information payment transaction.	<PmtTx>
PaymentIdentification	<PmtId>
InstructionIdentification	<InstrId>ABC1234</InstrId>
EndToEndIdentification	<EndToEndId>ABC1234</EndToEndId>
EndPaymentIdentification	</PmtId>
Amount	<Amt>
InstructedAmount	<InstAmt>12345678.90</InstAmt>
End of Amount	</Amt>
Final Agent	<FnlAgt>
BIC	<BIC>BANKATWWXXX</BIC>
End of Final Agent	</FnlAgt>
RemittanceInformation	<RmtInf>
Unstructured	<Ustrd>ABC1234</Ustrd>
EndRemittanceInformation	</RmtInf>
End of Information payment transaction.	</PmtTx>
EndPaymentInformation	</PmtInf>
End of SSP Proprietary Data	</SspPrtryDt>
End of Proprietary Data	</PrtryDt>

End Message Type

</pain.998.001.01>

ASTransferInitiation_4b

Scope: This message is sent by the AS or the CB on its behalf to debit / credit a collection of transactions in the framework of Model 6 (Settlement)

-----Addressing validations rules-----

Sender= DN of the AS or DN of the CB on behalf of the AS

Case 1: FirstAgent= BIC of a Settlement Bank, Domestic account = sub-account , FinalAgent =BIC of a Technical Account

Case 2: FirstAgent= BIC of a Technical Account, FinalAgent = BIC of a Settlement Bank, Domestic account = Sub-account of the Settlement Bank or empty (for Main account)

Message Type	<pain.998.001.01>
Proprietary Data	<PrtryDt>
Proprietary Data type	<Tp>ASTransferInitiation</Tp>
SSP Proprietary Data	<SspPrtryDt>
GroupHeader	<GrpHdr>
GroupIdentification	<GrpId>ABC1234</GrpId>
CreationDateTime	<CreDtTm>2007-07-01T11:25:00</CreDtTm>
ControlSum	<CtrlSum>1000.00</CtrlSum>
NumberOfTransactions	<NbOfTxes>2</NbOfTxes>
Priority	<Prty>HIGH</Prty>
SettlementModelType	<SttlmMdlTp>6000</SttlmMdlTp>
InitiatingParty	<InitgPty>
Financial institution	<FI>
BIC	<BIC>ANCILU2LXXX</BIC>
End of financial institution	</FI>
EndInitiatingParty	</InitgPty>
EndGroupHeader	</GrpHdr>
PaymentInformation	<PmtInf>
RequestedExecutionDate	<ReqdExctnDt>2007-07-01</ReqdExctnDt>
CreditTransferTypeIdentification	<CdtTrfTpId>
SettlementPriorityChoice	<SttlmPrty>
PaymentScheme	<PmtSchme>
Code	<Cd>SET</Cd>
EndPaymentScheme	</PmtSchme>
EndSettlementPriorityChoice	</SttlmPrty>
EndCreditTransferTypeIdentification	</CdtTrfTpId>
First Agent	<FrstAgt>
BIC	<BIC>STBKLU2L123</BIC>
End First Agent	</FrstAgt>
FirstAgentAccount	<FrstAgtAcct>
Simple Identification Information	<DmstAcct>
Identification	<Id>LU12345AB01</Id>
End of simple Identification Information	</DmstAcct>
EndFirstAgentAccount	</FrstAgtAcct>
Information payment transaction.	<PmtTx>
PaymentIdentification	<PmtId>
InstructionIdentification	<InstrId>ABC1234</InstrId>
EndToEndIdentification	<EndToEndId>ABC1234</EndToEndId>
EndPaymentIdentification	</PmtId>
Amount	<Amt>
InstructedAmount	<InstAmt>500.00</InstAmt>
End of Amount	</Amt>
Final Agent	<FnlAgt>

BIC	<BIC>ANCIFRPTEC</BIC>
End of Final Agent	</FnIAgt>
RemittanceInformation	<RmtInf>
Unstructured	<Ustrd>ABC1234</Ustrd>
EndRemittanceInformation	</RmtInf>
End of Information payment transaction.	</PmtTx>
EndPaymentInformation	</PmtInf>
PaymentInformation	<PmtInf>
RequestedExecutionDate	<ReqdExctnDt>2007-07-01</ReqdExctnDt>
CreditTransferTypeIdentification	<CdtTrfTpId>
SettlementPriorityChoice	<SttlmPrty>
PaymentScheme	<PmtSchme>
Code	<Cd>SET</Cd>
EndPaymentScheme	</PmtSchme>
EndSettlementPriorityChoice	</SttlmPrty>
EndCreditTransferTypeIdentification	</CdtTrfTpId>
First Agent	<FrstAgt>
BIC	<BIC>ANCIFRPTEC</BIC>
End First Agent	</FrstAgt>
Information payment transaction.	<PmtTx>
PaymentIdentification	<PmtId>
InstructionIdentification	<InstrId>XYZ9876</InstrId>
EndToEndIdentification	<EndToEndId>ZYX9876</EndToEndId>
EndPaymentIdentification	</PmtId>
Amount	<Amt>
InstructedAmount	<InstAmt>500.00</InstAmt>
End of Amount	</Amt>
Final Agent	<FnIAgt>
BIC	<BIC>CREDLU2L987</BIC>
End of Final Agent	</FnIAgt>
FinalAgentAccount	<FnIAgtAcct>
Simple Identification Information	<DmstAcct>
Identification	<Id>CRED12345AB01</Id>
End of simple Identification Information	</DmstAcct>
EndFinalAgentAccount	</FnIAgtAcct>
RemittanceInformation	<RmtInf>
Unstructured	<Ustrd>ABC1234</Ustrd>
EndRemittanceInformation	</RmtInf>
End of Information payment transaction.	</PmtTx>
EndPaymentInformation	</PmtInf>
End of SSP Proprietary Data	</SspPrtryDt>
End of Proprietary Data	</PrtryDt>
End Message Type	</pain.998.001.01>

ASTransferInitiation_4c

Scope: This message is sent by the AS or the CB on its behalf to debit / credit the RGS account of a Settlement Bank against one of its sub-accounts (interfaced model) or against the Technical account - procedure 6 real-time (real-time model)

-----Addressing validations rules-----

Sender= DN of the AS or DN of the CB on behalf of the AS

Case 1: FirstAgent= BIC of a Settlement Bank, FinalAgent = BIC and sub-account of this Settlement Bank

Case 2: FirstAgent= BIC and sub-account of a Settlement Bank, FinalAgent = BIC of the Settlement Bank

Case 3: FirstAgent = BIC of a Settlement Bank, FinalAgent = BIC of the Technical account - procedure 6 real-time

Case 4: FirstAgent = BIC of the Technical account - procedure 6 real-time, FinalAgent = BIC of the Settlement Bank

Message Type	<pain.998.001.01>
Proprietary Data	<PrtryDt>
Proprietary Data type	<Tp>ASTransferInitiation</Tp>
SSP Proprietary Data	<SspPrtryDt>
GroupHeader	<GrpHdr>
GroupIdentification	<Grpld>ABC1234</Grpld>
CreationDateTime	<CreDtTm>2007-07-01T11:25:00</CreDtTm>
ControlSum	<CtrlSum>1000.00</CtrlSum>
NumberOfTransactions	<NbOfTx>2</NbOfTx>
Priority	<Prty>HIGH</Prty>
SettlementModelType	<SttlmMdlTp>6000</SttlmMdlTp>
InitiatingParty	<InitgPty>
Financial institution	<FI>
BIC	<BIC>ANCILU2LXXX</BIC>
End of financial institution	</FI>
EndInitiatingParty	</InitgPty>
EndGroupHeader	</GrpHdr>
PaymentInformation	<PmtInf>
RequestedExecutionDate	<ReqdExctnDt>2007-07-01</ReqdExctnDt>
CreditTransferTypeIdentification	<CdtTrfTpId>
SettlementPriorityChoice	<SttlmPrty>
PaymentScheme	<PmtSchme>
Code	<Cd>CUO</Cd>
EndPaymentScheme	</PmtSchme>
EndSettlementPriorityChoice	</SttlmPrty>
EndCreditTransferTypeIdentification	</CdtTrfTpId>
First Agent	<FrstAgt>
BIC	<BIC>STBKLU2L123</BIC>
End First Agent	</FrstAgt>
FirstAgentAccount	<FrstAgtAcct>
Simple Identification Information	<DmstAcct>
Identification	<Id>LU12345AB01</Id>
End of simple Identification Information	</DmstAcct>
EndFirstAgentAccount	</FrstAgtAcct>
Information payment transaction.	<PmtTx>
PaymentIdentification	<PmtId>
InstructionIdentification	<InstrId>ABC1234</InstrId>
EndToEndIdentification	<EndToEndId>ABC1234</EndToEndId>
EndPaymentIdentification	</PmtId>
Amount	<Amt>
InstructedAmount	<InstAmt>500.00</InstAmt>
End of Amount	</Amt>
Final Agent	<FnlAgt>
BIC	<BIC>STBKLU2L123</BIC>

End of Final Agent	</FnIAgt>
RemittanceInformation	<RmtInf>
Unstructured	<Ustrd>ABC1234</Ustrd>
EndRemittanceInformation	</RmtInf>
End of Information payment transaction.	</PmtTx>
EndPaymentInformation	</PmtInf>
PaymentInformation	<PmtInf>
RequestedExecutionDate	<ReqdExctnDt>2007-07-01</ReqdExctnDt>
CreditTransferTypeIdentification	<CdtTrfTpId>
SettlementPriorityChoice	<SttlmPrty>
PaymentScheme	<PmtSchme>
Code	<Cd>CUO</Cd>
EndPaymentScheme	</PmtSchme>
EndSettlementPriorityChoice	</SttlmPrty>
EndCreditTransferTypeIdentification	</CdtTrfTpId>
First Agent	<FrstAgt>
BIC	<BIC>CREDLU2L987</BIC>
End First Agent	</FrstAgt>
Information payment transaction.	<PmtTx>
PaymentIdentification	<PmtId>
InstructionIdentification	<InstrId>XYZ9876</InstrId>
EndToEndIdentification	<EndToEndId>ZYX9876</EndToEndId>
EndPaymentIdentification	</PmtId>
Amount	<Amt>
InstructedAmount	<InstAmt>500.00</InstAmt>
End of Amount	</Amt>
Final Agent	<FnIAgt>
BIC	<BIC>CREDLU2L987</BIC>
End of Final Agent	</FnIAgt>
FinalAgentAccount	<FnIAgtAcct>
Simple Identification Information	<DmstAcct>
Identification	<Id>CRED12345AB01</Id>
End of simple Identification Information	</DmstAcct>
EndFinalAgentAccount	</FnIAgtAcct>
RemittanceInformation	<RmtInf>
Unstructured	<Ustrd>ABC1234</Ustrd>
EndRemittanceInformation	</RmtInf>
End of Information payment transaction.	</PmtTx>
EndPaymentInformation	</PmtInf>
End of SSP Proprietary Data	</SspPrtryDt>
End of Proprietary Data	</PrtryDt>
End Message Type	</pain.998.001.01>

ASTransferInitiation_4e

Scope: This message sent by an AS or the CB on its behalf contents specific transactions to debit the Technical account and credit the sub-account or the Main account of a settlement bank.

-----Addressing validations rules-----

Sender= DN of the AS or DN of the CB on behalf of the AS

FirstAgent = BIC of the Technical Account FinalAgent = BIC of the Settlement Bank, DomesticAccount = Sub-Account or empty (for Main Account)

Message Type	<pain.998.001.01>
Proprietary Data	<PrtryDt>
Proprietary Data type	<Tp>ASTransferInitiation</Tp>
SSP Proprietary Data	<SspPrtryDt>
GroupHeader	<GrpHdr>
GroupIdentification	<GrpId>ABC1234</GrpId>
CreationDateTime	<CreDtTm>2007-07-01T11:25:00</CreDtTm>
ControlSum	<CtrlSum>1000.00</CtrlSum>
NumberOfTransactions	<NbOfTx>2</NbOfTx>
Priority	<Prty>HIGH</Prty>
SettlementModelType	<StlmMdlTp>6000</StlmMdlTp>
EndGroupHeader	</GrpHdr>
PaymentInformation	<PmtInf>
RequestedExecutionDate	<ReqdExctnDt>2007-07-01</ReqdExctnDt>
RequestedExecutionDate	<ReqdExctnDt>2007-07-01</ReqdExctnDt>
CreditTransferTypeIdentification	<CdtTrfTpId>
SettlementPriorityChoice	<StlmPrty>
PaymentScheme	<PmtSchme>
Code	<Cd>STR</Cd>
EndPaymentScheme	</PmtSchme>
EndSettlementPriorityChoice	</StlmPrty>
EndCreditTransferTypeIdentification	</CdtTrfTpId>
First Agent	<FrstAgt>
BIC	<BIC>ANCILU2LTEC</BIC>
End First Agent	</FrstAgt>
Information payment transaction.	<PmtTx>
PaymentIdentification	<PmtId>
InstructionIdentification	<InstrId>ABC1234</InstrId>
EndToEndIdentification	<EndToEndId>ABC1234</EndToEndId>
EndPaymentIdentification	</PmtId>
Amount	<Amt>
InstructedAmount	<InstAmt>500.00</InstAmt>
End of Amount	</Amt>
Final Agent	<FnlAgt>
BIC	<BIC>STBKLU2L123</BIC>
End of Final Agent	</FnlAgt>
RemittanceInformation	<RmtInf>
Unstructured	<Ustrd>ABC1234</Ustrd>
EndRemittanceInformation	</RmtInf>
End of Information payment transaction.	</PmtTx>
EndPaymentInformation	</PmtInf>
PaymentInformation	<PmtInf>
CreditTransferTypeIdentification	<CdtTrfTpId>
SettlementPriorityChoice	<StlmPrty>
PaymentScheme	<PmtSchme>

Code	<Cd>STR</Cd>
EndPaymentScheme	</PmtSchme>
EndSettlementPriorityChoice	</SttlmPrty>
EndCreditTransferTypeIdentification	</CdtTrfTpld>
First Agent	<FrstAgt>
BIC	<BIC>ANCILU2LTEC</BIC>
End First Agent	</FrstAgt>
Information payment transaction.	<PmtTx>
PaymentIdentification	<PmtId>
InstructionIdentification	<InstrId>XYZ9876</InstrId>
EndToEndIdentification	<EndToEndId>ZYX9876</EndToEndId>
EndPaymentIdentification	</PmtId>
Amount	<Amt>
InstructedAmount	<InstAmt>500.00</InstAmt>
End of Amount	</Amt>
Final Agent	<FnIAgt>
BIC	<BIC>STBKLU2L123</BIC>
End of Final Agent	</FnIAgt>
FinalAgentAccount	<FnIAgtAcct>
Simple Identification Information	<DmstAcct>
Identification	<Id>STBK12345AB01</Id>
End of simple Identification Information	</DmstAcct>
EndFinalAgentAccount	</FnIAgtAcct>
RemittanceInformation	<RmtInf>
Unstructured	<Ustrd>ABC1234</Ustrd>
EndRemittanceInformation	</RmtInf>
End of Information payment transaction.	</PmtTx>
EndPaymentInformation	</PmtInf>
End of SSP Proprietary Data	</SspPrtryDt>
End of Proprietary Data	</PrtryDt>
End Message Type	</pain.998.001.01>

ASTransferInitiation_4f

Scope: This message is sent by the CB or the AS on its behalf to execute an automatic increase of liquidity with credit lines managed in proprietary home account, from a BIC RTGS account of a CB to the sub-account of a Settlement Bank during a cycle .
The same structure of message with the Payment scheme code "REP" will be used for repo countries to increase liquidity on SSS cash accounts during a cycle.

-----Addressing validations rules-----

Sender= DN of the CB or DN of the AS on behalf of the CB

FirstAgent= BIC of the CB FinalAgent = BIC and sub-account of a Settlement Bank (with same Home CB as the AS)

Message Type	<pain.998.001.01>
Proprietary Data	<PrtryDt>
Proprietary Data type	<Tp>ASTransferInitiation</Tp>
SSP Proprietary Data	<SspPrtryDt>
GroupHeader	<GrpHdr>
GroupIdentification	<Grpld>ABC1234</Grpld>
CreationDateTime	<CreDtTm>2007-07-01T11:25:00</CreDtTm>
ControlSum	<CtrlSum>1000.00</CtrlSum>
NumberOfTransactions	<NbOfTxs>2</NbOfTxs>
Priority	<Prty>HIGH</Prty>
SettlementModelType	<StlmMdlTp>6000</StlmMdlTp>
EndGroupHeader	</GrpHdr>
PaymentInformation	<PmtInf>
RequestedExecutionDate	<ReqdExctnDt>2007-07-01</ReqdExctnDt>
CreditTransferTypeIdentification	<CdtTrfTpId>
SettlementPriorityChoice	<StlmPrty>
PaymentScheme	<PmtSchme>
Code	<Cd>CHA</Cd>
EndPaymentScheme	</PmtSchme>
EndSettlementPriorityChoice	</StlmPrty>
EndCreditTransferTypeIdentification	</CdtTrfTpId>
First Agent	<FrstAgt>
BIC	<BIC>CBCBLU2LXXX</BIC>
End First Agent	</FrstAgt>
Information payment transaction.	<PmtTx>
PaymentIdentification	<PmtId>
InstructionIdentification	<InstrId>ABC1234</InstrId>
EndToEndIdentification	<EndToEndId>ABC1234</EndToEndId>
EndPaymentIdentification	</PmtId>
Amount	<Amt>
InstructedAmount	<InstAmt>500.00</InstAmt>
End of Amount	</Amt>
Final Agent	<FnIAgt>
BIC	<BIC>STBKLU2L123</BIC>
End of Final Agent	</FnIAgt>
FinalAgentAccount	<FnIAgtAcct>
Simple Identification Information	<DmstAcct>
Identification	<Id>STBK123456ABC</Id>
End of simple Identification Information	</DmstAcct>
EndFinalAgentAccount	</FnIAgtAcct>
RemittanceInformation	<RmtInf>
Unstructured	<Ustrd>ABC1234</Ustrd>
EndRemittanceInformation	</RmtInf>

End of Information payment transaction.	</PmtTx>
EndPaymentInformation	</PmtInf>
PaymentInformation	<PmtInf>
RequestedExecutionDate	<ReqdExctnDt>2007-07-01</ReqdExctnDt>
CreditTransferTypeIdentification	<CdtTrfTpId>
SettlementPriorityChoice	<SttlmPrty>
PaymentScheme	<PmtSchme>
Code	<Cd>CHA</Cd>
EndPaymentScheme	</PmtSchme>
EndSettlementPriorityChoice	</SttlmPrty>
EndCreditTransferTypeIdentification	</CdtTrfTpId>
First Agent	<FrstAgt>
BIC	<BIC>CBCBLU2LXXX</BIC>
End First Agent	</FrstAgt>
Information payment transaction.	<PmtTx>
PaymentIdentification	<PmtId>
InstructionIdentification	<InstrId>XYZ9876</InstrId>
EndToEndIdentification	<EndToEndId>ZYX9876</EndToEndId>
EndPaymentIdentification	</PmtId>
Amount	<Amt>
InstructedAmount	<InstAmt>500.00</InstAmt>
End of Amount	</Amt>
Final Agent	<FnIAgt>
BIC	<BIC>STBKLU2L456</BIC>
End of Final Agent	</FnIAgt>
FinalAgentAccount	<FnIAgtAcct>
Simple Identification Information	<DmstAcct>
Identification	<Id>LU45645AB01</Id>
End of simple Identification Information	</DmstAcct>
EndFinalAgentAccount	</FnIAgtAcct>
RemittanceInformation	<RmtInf>
Unstructured	<Ustrd>ABC1234</Ustrd>
EndRemittanceInformation	</RmtInf>
End of Information payment transaction.	</PmtTx>
EndPaymentInformation	</PmtInf>
End of SSP Proprietary Data	</SspPrtryDt>
End of Proprietary Data	</PrtryDt>
End Message Type	</pain.998.001.01>

ASTransferInitiation_4g

Scope: This message is sent by the AS or the CB on its behalf to execute a set of mandated payments debiting a specific auto-collateral account against the settlement decicated sub-accounts.

-----Addressing validations rules-----

Sender= DN of the AS or of the CB on behalf of the AS

FirstAgent= BIC of auto-collateral account (with same Home CB as the AS), FinalAgent = BIC and sub-account of a Settlement Bank (with same Home CB as the AS)

Message Type	<pain.998.001.01>
Proprietary Data	<PrtryDt>
Proprietary Data type	<Tp>ASTransferInitiation</Tp>
SSP Proprietary Data	<SspPrtryDt>
GroupHeader	<GrpHdr>
GroupIdentification	<Grpld>ABC1234</Grpld>
CreationDateTime	<CreDtTm>2007-07-01T11:25:00</CreDtTm>
ControlSum	<CtrlSum>1000.00</CtrlSum>
NumberOfTransactions	<NbOfTxs>2</NbOfTxs>
Priority	<Prty>HIGH</Prty>
SettlementModelType	<StlmMdlTp>6000</StlmMdlTp>
InitiatingParty	<InitgPty>
Financial institution	<FI>
BIC	<BIC>ANCILU2LXXX</BIC>
End of financial institution	</FI>
EndInitiatingParty	</InitgPty>
EndGroupHeader	</GrpHdr>
PaymentInformation	<PmtInf>
RequestedExecutionDate	<ReqdExctnDt>2007-07-01</ReqdExctnDt>
CreditTransferTypeIdentification	<CdtTrfTpId>
SettlementPriorityChoice	<StlmPrty>
PaymentScheme	<PmtSchme>
Code	<Cd>COL</Cd>
EndPaymentScheme	</PmtSchme>
EndSettlementPriorityChoice	</StlmPrty>
EndCreditTransferTypeIdentification	</CdtTrfTpId>
First Agent	<FrstAgt>
BIC	<BIC>CMIRLU2LXXX</BIC>
End First Agent	</FrstAgt>
Information payment transaction.	<PmtTx>
PaymentIdentification	<PmtId>
InstructionIdentification	<InstrId>ABC1234</InstrId>
EndToEndIdentification	<EndToEndId>ABC1234</EndToEndId>
EndPaymentIdentification	</PmtId>
Amount	<Amt>
InstructedAmount	<InstAmt>500.00</InstAmt>
End of Amount	</Amt>
Final Agent	<FnIAgt>
BIC	<BIC>STBKLU2L123</BIC>
End of Final Agent	</FnIAgt>
FinalAgentAccount	<FnIAgtAcct>
Simple Identification Information	<DmstAcct>
Identification	<Id>STBK123456ABC</Id>
End of simple Identification Information	</DmstAcct>
EndFinalAgentAccount	</FnIAgtAcct>

RemittanceInformation	<RmtInf>
Unstructured	<Ustrd>ABC1234</Ustrd>
EndRemittanceInformation	</RmtInf>
End of Information payment transaction.	</PmtTx>
EndPaymentInformation	</PmtInf>
PaymentInformation	<PmtInf>
RequestedExecutionDate	<ReqdExctnDt>2007-07-01</ReqdExctnDt>
CreditTransferTypeIdentification	<CdtTrfTpId>
SettlementPriorityChoice	<SttlmPrty>
PaymentScheme	<PmtSchme>
Code	<Cd>COL</Cd>
EndPaymentScheme	</PmtSchme>
EndSettlementPriorityChoice	</SttlmPrty>
EndCreditTransferTypeIdentification	</CdtTrfTpId>
First Agent	<FrstAgt>
BIC	<BIC>CMIRLU2LXXX</BIC>
End First Agent	</FrstAgt>
Information payment transaction.	<PmtTx>
PaymentIdentification	<PmtId>
InstructionIdentification	<InstrId>XYZ9876</InstrId>
EndToEndIdentification	<EndToEndId>ZYX9876</EndToEndId>
EndPaymentIdentification	</PmtId>
Amount	<Amt>
InstructedAmount	<InstAmt>500.00</InstAmt>
End of Amount	</Amt>
Final Agent	<FnIAgt>
BIC	<BIC>STBKLU2L456</BIC>
End of Final Agent	</FnIAgt>
FinalAgentAccount	<FnIAgtAcct>
Simple Identification Information	<DmstAcct>
Identification	<Id>LU45645AB01</Id>
End of simple Identification Information	</DmstAcct>
EndFinalAgentAccount	</FnIAgtAcct>
RemittanceInformation	<RmtInf>
Unstructured	<Ustrd>ABC1234</Ustrd>
EndRemittanceInformation	</RmtInf>
End of Information payment transaction.	</PmtTx>
EndPaymentInformation	</PmtInf>
End of SSP Proprietary Data	</SspPrtryDt>
End of Proprietary Data	</PrtryDt>
End Message Type	</pain.998.001.01>

ASTransferInitiation_4h

Scope: This message is sent by an Interfaced AS1 to execute, with the model 6, a Cross AS settlement from a sub-account of Settlement bank A to the Technical account - procedure 6 real-time of a real-time AS2 on behalf of Settlement bank B (Creditor)

---Addressing validations rules---

Sender = DN of the Interfaced AS1

Counterpart AS = BIC of the real-time AS2

FirstAgent = BIC of a settlement Bank in AS1, DomesticAccount = Sub-account number

FinalAgent = BIC of the Technical account - procedure 6 real-time of AS2, Creditor = BIC of a Settlement Bank in AS2

Message Type	<pain.998.001.01>
Proprietary Data	<PrtryDt>
Proprietary Data type	<Tp>ASTransferInitiation</Tp>
SSP Proprietary Data	<SspPrtryDt>
GroupHeader	<GrpHdr>
GroupIdentification	<GrpId>ABC1234</GrpId>
CreationDateTime	<CreDtTm>2008-10-01T11:30:00</CreDtTm>
ControlSum	<CtrlSum>12345678.90</CtrlSum>
NumberOfTransactions	<NbOfTx>1</NbOfTx>
Priority	<Prty>HIGH</Prty>
SettlementModelType	<StlmMdlTp>6000</StlmMdlTp>
Counterpart AS	<CtpAS>
Financial institution	<FI>
BIC	<BIC>ANCIFRWWXXX</BIC>
End of financial institution	</FI>
End of Counterpart AS	</CtpAS>
EndGroupHeader	</GrpHdr>
PaymentInformation	<PmtInf>
RequestedExecutionDate	<ReqdExctnDt>2008-10-01</ReqdExctnDt>
CreditTransferTypeIdentification	<CdtTrfTpId>
SettlementPriorityChoice	<StlmPrty>
PaymentScheme	<PmtSchme>
Code	<Cd>CDS</Cd>
EndPaymentScheme	</PmtSchme>
EndSettlementPriorityChoice	</StlmPrty>
EndCreditTransferTypeIdentification	</CdtTrfTpId>
First Agent	<FrstAgt>
BIC	<BIC>BANKATWWXXX</BIC>
End First Agent	</FrstAgt>
FirstAgentAccount	<FrstAgtAcct>
Simple Identification Information	<DmstAcct>
Identification	<Id>AT12345SUBACC01</Id>
End of simple Identification Information	</DmstAcct>
EndFirstAgentAccount	</FrstAgtAcct>
Information payment transaction.	<PmtTx>
PaymentIdentification	<PmtId>
InstructionIdentification	<InstrId>ABC1234</InstrId>
EndToEndIdentification	<EndToEndId>ABC1234</EndToEndId>
EndPaymentIdentification	</PmtId>
Amount	<Amt>
InstructedAmount	<InstAmt>12345678.90</InstAmt>
End of Amount	</Amt>
Creditor	<Cdtr>
Financial institution	<FI>
BIC	<BIC>BANKFRPPXXX</BIC>

End of financial institution		</FI>
End of Creditor		</Cdtr>
Final Agent		<FnIAgt>
BIC		<BIC>MIROFRWWAS2</BIC>
End of Final Agent		</FnIAgt>
RemittanceInformation		<RmtInf>
Unstructured		<Ustrd>ABC1234</Ustrd>
EndRemittanceInformation		</RmtInf>
End of Information payment transaction.		</PmtTx>
EndPaymentInformation		</PmtInf>
End of SSP Proprietary Data		</SspPrtryDt>
End of Proprietary Data		</PrtryDt>
End Message Type		</pain.998.001.01>

6. 6. 3 ASTransferNotice

SSP Proprietary Messages

ASTransferNotice

Scope: 1) The message is sent by the ASI to the AS in model 1 or 6 to notify the incoming liquidity on the Technical account - procedure 6 real-time
 -from a MT202 sent by a Settlement Bank or
 -after execution of Standing Orders or
 -after liquidity adjustment by Settlement Bank via ICM
 The ASTransferNotice is used as single as it contains only the data relative one transfer to the Technical account - procedure 6 real-time by a Settlement Bank.
 The Technical account - procedure 6 real-time of the AS is specified in the FinalAgent.
 The beneficiary in the SSS is specified as the Creditor.

In this case the field "CounterpatAS" is not filled.

2) In case of Cross-AS settlement:
 The field "CounterpartAS" is filled.
 The message is sent by the ASI to the AS (Interfaced or real-time) in model 6 to notify the incoming liquidity from a cross AS settlement sent by another AS (Interfaced or real-time) via an ASTransferInitiation.
 The ASTransferNotice is used as single as it contains the data relative to the amount coming from a sub-account/Technical account - procedure 6 real-time to a sub-account/Technical account - procedure 6 real-time.
 The ASTransferNotice is used to notify the Interfaced and real-time AS with the following parameters contained in the ASTransferInitiation sent by the counterpart AS:
 - BIC of the counterpart AS
 - InstructionIdentification
 - EndToEndIdentification
 - FirstAgent and FinalAgent
 - The Settlement Bank linked to a real-time AS sender is filled in the Debtor BIC
 - The Settlement Bank linked to a real-time AS receiver is filled in the Creditor BIC
 - The resulting balance in the sub-account or in the Technical account - procedure 6 real-time

Structure:

Message Type	<pain.998.001.01>
Proprietary Data	<PrtryDt>
Proprietary Data type	<Tp>ASTransferNotice</Tp>
SSP Proprietary Data	<SspPrtryDt>
GroupHeader	<GrpHdr>
GroupIdentification	<Grpld></Grpld>
CreationDateTime	<CreDtTm></CreDtTm>
ControlSum	<CtrlSum></CtrlSum>
NumberOfTransactions	<NbOfTx></NbOfTx>
Priority	<Prty></Prty>
SettlementModelType	<StlmMdlTp></StlmMdlTp>
Counterpart AS	<CtpAS>
Financial institution	<FI>
BIC	<BIC></BIC>
End of financial institution	</FI>
End of Counterpart AS	</CtpAS>
EndGroupHeader	</GrpHdr>
PaymentInformation	<PmtInf>
RequestExecutionDate	<ReqdExctnDt></ReqdExctnDt>
CreditTransferTypeIdentification	<CdtTrfTpId>
SettlementPriorityChoice	<StlmPrty>
PaymentScheme	<PmtSchme>
Code	<Cd></Cd>
EndPaymentScheme	</PmtSchme>
EndSettlementPriorityChoice	</StlmPrty>
EndCreditTransferTypeIdentification	</CdtTrfTpId>
Debtor	<Dbtr>
Name of the account. An additional identification	<Nm></Nm>
Financial institution	<FI>

BIC	<BIC></BIC>
End of financial institution	</FI>
End of debtor	</Dbtr>
DebtorAccount	<DbtrAcct>
Simple Identification Information	<DmstAcct>
Identification	<Id></Id>
End of simple Identification Information	</DmstAcct>
EndDebtorAccount	</DbtrAcct>
First Agent	<FrstAgt>
BIC	<BIC></BIC>
End First Agent	</FrstAgt>
FirstAgentAccount	<FrstAgtAcct>
Simple Identification Information	<DmstAcct>
Identification	<Id></Id>
End of simple Identification Information	</DmstAcct>
EndFirstAgentAccount	</FrstAgtAcct>
Information payment transaction.	<PmtTx>
PaymentIdentification	<PmtId>
InstructionIdentification	<InstrId></InstrId>
EndToEndIdentification	<EndToEndId></EndToEndId>
EndPaymentIdentification	</PmtId>
Amount	<Amt>
InstructedAmount	<InstAmt></InstAmt>
End of Amount	</Amt>
Creditor	<Cdtr>
Name	<Nm></Nm>
Financial institution	<FI>
BIC	<BIC></BIC>
End of financial institution	</FI>
End of Creditor	</Cdtr>
CreditorAccount	<CdtrAcct>
Simple Identification Information	<DmstAcct>
Identification	<Id></Id>
End of simple Identification Information	</DmstAcct>
EndCreditorAccount	</CdtrAcct>
Final agent	<FnlAgt>
BIC	<BIC></BIC>
End of Final Agent	</FnlAgt>
FinalAgentAccount	<FnlAgtAcct>
Simple Identification Information	<DmstAcct>
Identification	<Id></Id>
End of simple Identification Information	</DmstAcct>
EndFinalAgentAccount	</FnlAgtAcct>
RemittanceInformation	<RmtInf>
Unstructured	<Ustrd></Ustrd>
EndRemittanceInformation	</RmtInf>
End of Information payment transaction.	</PmtTx>
EndPaymentInformation	</PmtInf>
ResultingBalance	<RsltgBal>
Amount	<Amt></Amt>
Credit or debit indicator	<CdtDbtInd></CdtDbtInd>
Value Date / Time	<ValDt>

Date Time					<DtTm></DtTm>
End of Value Date / Time					</ValDt>
End of ResultingBalance					</RsltgBal>
End of SSP Proprietary Data					</SspPrtryDt>
End of Proprietary Data					</PrtryDt>
End Message Type					</pain.998.001.01>

Attributes:

name of attribute	format	short description	description
<pain.998.001.01>		Message Type	SSP proprietary message for Ancillary system interface
		Mandatory	Validation: [1..1]
<PrtryDt>		Proprietary Data	
		Mandatory	Validation: [1..1]
<Tp>-</Tp>		Proprietary Data type	Proprietary Data type
		Mandatory	Validation: [1..1]always "ASTransferNotice"
<SspPrtryDt>		SSP Proprietary Data	Root element for all SSP proprietary data
		Mandatory	Validation: [1..1]
<GrpHdr>		GroupHeader	
		Mandatory	Validation: [1..1]
<Grpld>-</Grpld>	35x	GroupIdentification	Reference assigned by the sender to identify the group of individual transfers being sent =Reference assigned by the ASI to identify the notice being sent
		Mandatory	Validation: [1..1]
<CreDtTm>-</CreDtTm>	ISODateTime	CreationDateTime	Date and time at which the transaction was executed by the PM.
		Mandatory	Validation: [1..1]
<CtrlSum>-</CtrlSum>	DecimalNumber	ControlSum	Total of all the individual instructed amounts =Amount indicated in "PaymentTransaction"
		Optional	Validation: [0..1]
<NbOfTxs>-</NbOfTxs>	15n	NumberOfTransactions	Number of individual transactions contained in the payment initiation, ie the number of occurrences of PaymentTransaction = "1"
		Optional	Validation: [0..1]
<Prty>-</Prty>	4x	Priority	Priority of all the payments at Group level = "HIGH"
		Optional	Validation: [0..1]
<SttlmMdlTp>-</SttlmMdlTp>		SettlementModelType	Specifies the generic settlement Procedure 1000 = Procedure 1 (Liquidity transfer) 2000 = Procedure 2 (Real time settlement) 3000 = Procedure 3 (Bilateral settlement) 4000 = Procedure 4 (Standard multilateral settlement) 5000 = Procedure 5 (Simultaneous multilateral settlement) 6000 = Procedure 6 (Settlement on dedicated liquidity) Filled with "1000" or "6000"
		Mandatory	Validation:

name of attribute	format	short description	description
			[1..1]
<CtpAS>		Counterpart AS	Counterpart AS
		Optional	Validation: [0..1]
<FI>		Financial institution	Financial institution
		Mandatory	Validation: [1..1]
<BIC>-</BIC>	11x	BIC	BIC BIC of the AS sender of the cross-AS transaction
		Mandatory	Validation: [1..1]
</FI>		End of financial institution	End of financial institution
		Mandatory	Validation: [1..1]
</CtpAS>		End of Counterpart AS	End of Counterpart AS
		Optional	Validation: [0..1]
</GrpHdr>		EndGroupHeader	
		Mandatory	Validation: [1..1]
<PmtInf>		PaymentInformation	Set of characteristics that applies to the debit side of the payment transactions
		Mandatory	Validation: [1..n]
<ReqdExctnDt>-</ReqdExctnDt>	ISODate	RequestExecutionDate	Date at which the initiating party requests that the payment instruction be processed (=settlement date) =Business date at which the credit transfer or standing order was executed by the PM
		Mandatory	Validation: [1..1]
<CdtTrfTpId>		CreditTransferTypeIdentification	Set of elements that further identifies the type of credit transfer requested
		Optional	Validation: [0..1]
<SttlmPrty>		SettlementPriorityChoice	Priority or specific payment
		Mandatory	Validation: [1..1]
<PmtSchme>		PaymentScheme	Specific rulebook governing the rules of settlement =Payment scheme code in case of Model 6
		Mandatory	Validation: [1..1]
<Cd>-</Cd>	Max3Alphan umericTxt	Code	"CDS" = Model 6 Cross AS Settlement between two AS "CUO" = Model 6 Current Order Current order sent either by an AS on behalf of a Settlement Bank

name of attribute	format	short description	description
			<p>"CSP" = Model 6 Connected SSP Automatic increase/decrease of liquidity by connected payments on SSP account</p> <p>"CHA" = Model 6 Connected Home Account Automatic increase/decrease of liquidity with credit lines managed in proprietary home account</p> <p>"COL" = Model 6 Auto-Collateral File of mandated payments to debit (credit) AS Auto collateral account and credit (debit) sub-accounts of Settlement Banks</p> <p>"REP" = Model 6 Auto-collateral for Repo countries Automatic increase/decrease of blocked liquidity by auto-collateralisation for repo countries</p> <p>"REP" = Model 1 to 5 REPO operations</p> <p>"STR" = Model 6 Specific Transactions Increase of dedicated liquidity triggered by specific transactions</p> <p>"SET" = Model 6 Settlement Settlement</p> <p>"SOR" = Model 6 Standing Order Code used only in ASTransferNotice to notify to the AS the funds booked on the Technical account - procedure 6 real-time after standing order execution</p> <p>Empty in case of Model 1 "SOR" to notify the StandinOrder execution</p>
		Mandatory	Validation: [1..1]
</PmtSchme>		EndPaymentScheme	
		Mandatory	Validation: [1..1]
</SttlmPrty>		EndSettlementPriorityChoice	
		Mandatory	Validation: [1..1]
</CdtTrfTpId>		EndCreditTransferTypeden- tification	
		Optional	Validation: [0..1]
<Dbtr>		Debtor	Information about the debtor of a payment. =ordering institution
		Optional	Validation: [0..1]
<Nm>-</Nm>	70x	Name of the account. An additional identification	<p>Name of the debtor</p> <p>Name of the debtor</p> <ul style="list-style-type: none"> • Copied from ASTransferInitiation if it is filled • Name of the ordering institution if it is filled in the field 52D of the MT202 <p>It will be truncated to the first 70 characters</p>
		Optional	Validation: [0..1]
<FI>		Financial institution	Financial institution
		Optional	Validation: [0..1]

name of attribute	format	short description	description
<BIC>-</BIC>	11x	BIC	BIC <ul style="list-style-type: none"> • Filled with the Debtor BIC if present in ASTransferInitiation • BIC of the ordering institution if it is filled in the field 52A of the MT202 or the standing order Mandatory Validation: [1..1]
</FI>		End of financial institution	End of financial institution Optional Validation: [0..1]
</Dbtr>		End of debtor	Optional Validation: [0..1]
<DbtrAcct>		DebtorAccount	Optional Validation: [0..1]
<DmstAcct>		Simple Identification Information	Simple Identification Information Mandatory Validation: [1..1]
<Id>-</Id>	35x	Identification	Identification of an entity <ul style="list-style-type: none"> • Copied from ASTransferInitiation if it is filled • Account number if it is filled in the field 52A of the MT202 Mandatory Validation: [1..1]
</DmstAcct>		End of simple Identification Information	Mandatory Validation: [1..1]
</DbtrAcct>		EndDebtorAccount	Optional Validation: [0..1]
<FrstAgt>		First Agent	Mandatory Validation: [1..1]
<BIC>-</BIC>	11x	BIC	BIC Filled with: <ul style="list-style-type: none"> • BIC of the Settlement Bank of the MT202 or the standing order • BIC of FirstAgent from ASTransferInitiation Mandatory Validation: [1..1]
</FrstAgt>		End First Agent	End First Agent Mandatory Validation: [1..1]
<FrstAgtAcct>		FirstAgentAccount	Optional Validation: [0..1]

name of attribute	format	short description	description
<DmstAcct>		Simple Identification Information Mandatory	Simple Identification Information Validation: [1..1]
<Id>-</Id>	35x	Identification Mandatory	Identification of an entity Filled with DomesticAccount of FirstAgent if present in ASTransferInitiation Validation: [1..1]
</DmstAcct>		End of simple Identification Information Mandatory	 Validation: [1..1]
</FrstAgtAcct>		EndFirstAgentAccount Optional	 Validation: [0..1]
<PmtTx>		Information payment transaction. Mandatory	Payment processes required to transfer cash from the debtor to the creditor. =Notice of Payment executed from the FirstAgent to the FinalAgent Validation: [1..1]
<PmtId>		PaymentIdentification Mandatory	Set of elements to provide further means of referencing a payment transaction Validation: [1..1]
<InstrId>-</InstrId>	16x	InstructionIdentification Mandatory	Unique and unambiguous identifier for a payment instruction assigned by the initiating party Filled with: • Transaction Reference Number (Field 20 of the MT202) • MessageIdentification from SBTransferInitiation • Same identification than EndToEndIdentification for Standing orders • InstructionIdentification from ASTransferInitiation Validation: [1..1]
<EndToEndId>-</EndToEndId>	16x	EndToEndIdentification Mandatory	Unique and unambiguous identification of a payment transaction, as assigned by any of the parties on the initiating side, that will be passed on throughout the entire end-to-end chain Filled with: • Related Reference (Field 21 of the MT202) • EndToEndIdentification from SBTransferInitiation • Reference assigned by the ASI to each Standing order • EndToEndIdentification from ASTransferInitiation Validation: [1..1]
</PmtId>		EndPaymentIdentification Mandatory	End of Set of elements to reference a payment transaction Validation: [1..1]
<Amt>		Amount Mandatory	 Validation: [1..1]

name of attribute	format	short description	description
<InstAmt>-</InstAmt>	18d	InstructedAmount	Amount of money to be transferred between debtor and creditor expressed in Euros Filled with: <ul style="list-style-type: none"> • Amount of Field 32A of the MT202 • Amount of the Standing order (eventually reduced by the ASI in a pro-rata mode) • Amount copied from SBTransferInitiation • Amount copied from ASTransferInitiation
		Mandatory	Validation: [1..1]
</Amt>		End of Amount	End of Amount
		Mandatory	Validation: [1..1]
<Cdtr>		Creditor	Party that receives an amount of money from the debtor
		Optional	Validation: [0..1]
<Nm>-</Nm>	70x	Name	<ul style="list-style-type: none"> • Name of the beneficiary if it is filled in the field 58D of the MT202 • Copied from ASTransferInitiation if it is filled It will be truncated to the first 70 characters
		Optional	Validation: [0..1]
<FI>		Financial institution	Financial institution
		Optional	Validation: [0..1]
<BIC>-</BIC>	11x	BIC	BIC Filled with the BIC of the beneficiary in the SSS: <ul style="list-style-type: none"> • Field 58A of MT202 or Standing order • BIC creditor in SBTransferInitiation • BIC creditor if present in ASTransferInitiation
		Mandatory	Validation: [1..1]
</FI>		End of financial institution	End of financial institution
		Optional	Validation: [0..1]
</Cdtr>		End of Creditor	
		Optional	Validation: [0..1]
<CdtrAcct>		CreditorAccount	
		Optional	Validation: [0..1]
<DmstAcct>		Simple Identification Information	Simple Identification Information
		Mandatory	Validation: [1..1]
<Id>-</Id>	35x	Identification	Identification of an entity Filled with the Account number if it is present: <ul style="list-style-type: none"> • Account in the SBTransferInitiation • Field 58A of standing order • Field 58A of MT202 • Account in the ASTransferInitiation

name of attribute	format	short description	description
		Mandatory	Validation: [1..1]
</DmstAcct>		End of simple Identification Information Mandatory	Validation: [1..1]
</CdtrAcct>		EndCreditorAccount Optional	Validation: [0..1]
<FnIAgt>		Final agent Mandatory	Validation: [1..1]
<BIC>-</BIC>	11x	BIC Mandatory	BIC Filled with: • BIC of the Technical account - procedure 6 real-time (Field 57A of the MT202) • BIC of the FinalAgent from ASTransferInitiation Validation: [1..1]
</FnIAgt>		End of Final Agent Mandatory	End of Final Agent Validation: [1..1]
<FnIAgtAcct>		FinalAgentAccount Optional	Validation: [0..1]
<DmstAcct>		Simple Identification Information Mandatory	Simple Identification Information Validation: [1..1]
<Id>-</Id>	35x	Identification Mandatory	Identification of an entity Filled with DomesticAccount of FinalAgent if present in ASTransferInitiation Validation: [1..1]
</DmstAcct>		End of simple Identification Information Mandatory	Validation: [1..1]
</FnIAgtAcct>		EndFinalAgentAccount Optional	Validation: [0..1]
<RmtInf>		RemittanceInformation Optional	Validation: [0..1]
<Ustrd>-</Ustrd>	140x	Unstructured	Copy of the optional information in the original operation: • Introduced by the codeword /ASINF/ in the field 72 of the MT202, in case of Mandated payment the codeword /MANPAY/ will be added before /ASINF/ • Copy of the full field 72 of Standing orders • Copy of field RemittanceInformation of

name of attribute	format	short description	description
		Mandatory	SBTransferInitiation • Copy of field RemittanceInformation of ASTransferInitiation Validation: [1..1]
</RmtInf>		EndRemittanceInformation Optional	Validation: [0..1]
</PmtTx>		End of Information payment transaction. Mandatory	Validation: [1..1]
</PmtInf>		EndPaymentInformation Mandatory	Validation: [1..1]
<RsltgBal>		ResultingBalance Optional	Resulting Balance In case of Cross AS settlement, the new balance in the sub-account or in the Technical account - procedure 6 real-time. Validation: [0..1]
<Amt>-</Amt>	18d	Amount Mandatory	New balance in the sub-account or in the Technical account - procedure 6 real-time. Validation: [1..1]
<CdtDbtInd>-</CdtDbtInd>	4!a	Credit or debit indicator Mandatory	indicates whether the balance is a credit or a debit balance CRDT = Credit Balance is a credit balance. DBIT = Debit Balance is a debit balance. A zero balance is considered to be a credit balance. Validation: [1..1]
<ValDt>		Value Date / Time Optional	Date and time assets become available to the account owner (in a credit entry), or cease to be available to the account owner (in a debit entry). Date / Time at which the amount is or will be available. Validation: [0..1]
<DtTm>-</DtTm>	ISODateTim e	Date Time Mandatory	Settlement timestamp. The date and time must be considered separately because: Date = Business date Time = System time Validation: [1..1]
</ValDt>		End of Value Date / Time Optional	Validation: [0..1]

name of attribute	format	short description	description
</RsltgBal>		End of ResultingBalance Optional	Validation: [0..1]
</SspPrtryDt>		End of SSP Proprietary Data Mandatory	Validation: [1..1]
</PrtryDt>		End of Proprietary Data Mandatory	Validation: [1..1]
</pain.998.001.01>		End Message Type Mandatory	Validation: [1..1]

Error Codes:

ASTransferNotice_1

Scope: ASTransferNotice sent by the ASI to the AS (model 1)

The ASTransferNotice is sent by the ASI to the AS (real-time Model) to notice the incoming liquidity on the Technical account - procedure 6 real-time from a MT202 sent by a Settlement Bank

The ASTransferNotice is used as single as it contains only the data relative one transfer to the Technical account - procedure 6 real-time by a Settlement Bank.

The ordering institution (in field 52A) is filled in Debtor. The sender of MT202 is the FirstAgent.

The Technical account - procedure 6 real-time of the AS is specified in the FinalAgent

The beneficiary in the SSS is specified as the Creditor

Message Type	<pain.998.001.01>
Proprietary Data	<PrtryDt>
Proprietary Data type	<Tp>ASTransferNotice</Tp>
SSP Proprietary Data	<SspPrtryDt>
GroupHeader	<GrpHdr>
GroupIdentification	<GrpId>ABC1234</GrpId>
CreationDateTime	<CreDtTm>2007-01-01T12:00:00</CreDtTm>
ControlSum	<CtrlSum>12345678.90</CtrlSum>
NumberOfTransactions	<NbOfTxs>1</NbOfTxs>
Priority	<Prty>HIGH</Prty>
SettlementModelType	<SttlmMdlTp>1000</SttlmMdlTp>
EndGroupHeader	</GrpHdr>
PaymentInformation	<PmtInf>
RequestExecutionDate	<ReqdExctnDt>2007-01-01</ReqdExctnDt>
Debtor	<Dbtr>
Name of the account. An additional identification	<Nm>ABC1234</Nm>
Financial institution	<FI>
BIC	<BIC>BANKFRPPXXX</BIC>
End of financial institution	</FI>
End of debtor	</Dbtr>
DebtorAccount	<DbtrAcct>
Simple Identification Information	<DmstAcct>
Identification	<Id>ABC1234</Id>
End of simple Identification Information	</DmstAcct>
EndDebtorAccount	</DbtrAcct>
First Agent	<FrstAgt>
BIC	<BIC>CREDFRPPXXX</BIC>
End First Agent	</FrstAgt>
Information payment transaction.	<PmtTx>
PaymentIdentification	<PmtId>
InstructionIdentification	<InstrId>ABC1234</InstrId>
EndToEndIdentification	<EndToEndId>ABC1234</EndToEndId>
EndPaymentIdentification	</PmtId>
Amount	<Amt>
InstructedAmount	<InstAmt>12345678.90</InstAmt>
End of Amount	</Amt>
Creditor	<Cdtr>
Name	<Nm>ABC1234</Nm>
Financial institution	<FI>
BIC	<BIC>BANKFRPPXXX</BIC>
End of financial institution	</FI>
End of Creditor	</Cdtr>
CreditorAccount	<CdtrAcct>

Simple Identification Information	<DmstAcct>
Identification	<Id>ABC1234</Id>
End of simple Identification Information	</DmstAcct>
EndCreditorAccount	</CdtrAcct>
Final agent	<FnIAgt>
BIC	<BIC>ANCIFRPPMIR</BIC>
End of Final Agent	</FnIAgt>
RemittanceInformation	<RmtInf>
Unstructured	<Ustrd>ABC1234</Ustrd>
EndRemittanceInformation	</RmtInf>
End of Information payment transaction.	</PmtTx>
EndPaymentInformation	</PmtInf>
End of SSP Proprietary Data	</SspPrtryDt>
End of Proprietary Data	</PrtryDt>
End Message Type	</pain.998.001.01>

ASTransferNotice_2

Scope: ASTransferNotice sent by the ASI to the AS (Model 6, real-time Model) to notice the incoming liquidity on the Technical account - procedure 6 real-time after execution of Standing orders.

Rules:

Debtor : Ordering institution (Field 52)

FinalAgent : Settlement Bank which is debited in the SSP

Creditor : Final beneficiary to be credited on the SSS (Field 58)

Creditor domestic account : SSS account number which will receive the liquidity (Field 58_account)

Remittance information : Copy of field 72 of standing order

Message Type	<pain.998.001.01>
Proprietary Data	<PrtryDt>
Proprietary Data type	<Tp>ASTransferNotice</Tp>
SSP Proprietary Data	<SspPrtryDt>
GroupHeader	<GrpHdr>
GroupIdentification	<Grpld>ABC1234</Grpld>
CreationDateTime	<CreDtTm>2007-01-01T12:00:00</CreDtTm>
ControlSum	<CtrlSum>12345678.90</CtrlSum>
NumberOfTransactions	<NbOfTxs>1</NbOfTxs>
Priority	<Prty>HIGH</Prty>
SettlementModelType	<SttlmMdlTp>6000</SttlmMdlTp>
EndGroupHeader	</GrpHdr>
PaymentInformation	<PmtInf>
RequestExecutionDate	<ReqdExctnDt>2007-01-01</ReqdExctnDt>
CreditTransferTypeIdentification	<CdtTrfTpId>
SettlementPriorityChoice	<SttlmPrty>
PaymentScheme	<PmtSchme>
Code	<Cd>SOR</Cd>
EndPaymentScheme	</PmtSchme>
EndSettlementPriorityChoice	</SttlmPrty>
EndCreditTransferTypeIdentification	</CdtTrfTpId>
Debtor	<Dbtr>
Financial institution	<FI>
BIC	<BIC>AAAACDDXXX</BIC>
End of financial institution	</FI>
End of debtor	</Dbtr>
First Agent	<FrstAgt>
BIC	<BIC>BANKFRPPXXX</BIC>
End First Agent	</FrstAgt>
Information payment transaction.	<PmtTx>
PaymentIdentification	<PmtId>
InstructionIdentification	<InstrId>ABC1234</InstrId>
EndToEndIdentification	<EndToEndId>ABC1234</EndToEndId>
EndPaymentIdentification	</PmtId>
Amount	<Amt>
InstructedAmount	<InstAmt>12345678.90</InstAmt>
End of Amount	</Amt>
Creditor	<Cdtr>
Financial institution	<FI>
BIC	<BIC>CREDFRPPXXX</BIC>
End of financial institution	</FI>
End of Creditor	</Cdtr>
CreditorAccount	<CdtrAcct>
Simple Identification Information	<DmstAcct>

Identification										<Id>ABC1234</Id>
End of simple Identification Information										</DmstAcct>
EndCreditorAccount										</CdtrAcct>
Final agent										<FnIAgt>
BIC										<BIC>ANCIFRPPMIR</BIC>
End of Final Agent										</FnIAgt>
RemittanceInformation										<RmtInf>
Unstructured										<Ustrd>ABC1234</Ustrd>
EndRemittanceInformation										</RmtInf>
End of Information payment transaction.										</PmtTx>
EndPaymentInformation										</PmtInf>
End of SSP Proprietary Data										</SspPrtryDt>
End of Proprietary Data										</PrtryDt>
End Message Type										</pain.998.001.01>

ASTransferNotice_3

Scope: ASTransferNotice sent by the ASI to the AS (model 6) after liquidity adjustment by settlement bank via ICM

The ASTransferNotice is sent by the ASI to the AS (real-time Model) to notice the incoming liquidity on the Technical account - procedure 6 real-time from a current order sent by a Settlement Bank via ICM with an XML SBTransferInitiation or by an ICM screen.

Message Type	<pain.998.001.01>
Proprietary Data	<PrtryDt>
Proprietary Data type	<Tp>ASTransferNotice</Tp>
SSP Proprietary Data	<SspPrtryDt>
GroupHeader	<GrpHdr>
GroupIdentification	<GrpId>ABC1234</GrpId>
CreationDateTime	<CreDtTm>2007-01-01T12:00:00</CreDtTm>
ControlSum	<CtrlSum>12345678.90</CtrlSum>
NumberOfTransactions	<NbOfTxs>1</NbOfTxs>
Priority	<Prty>HIGH</Prty>
SettlementModelType	<SttlmMdlTp>6000</SttlmMdlTp>
EndGroupHeader	</GrpHdr>
PaymentInformation	<PmtInf>
RequestExecutionDate	<ReqdExctnDt>2007-01-01</ReqdExctnDt>
CreditTransferTypeIdentification	<CdtTrfTpId>
SettlementPriorityChoice	<SttlmPrty>
PaymentScheme	<PmtSchme>
Code	<Cd>CUO</Cd>
EndPaymentScheme	</PmtSchme>
EndSettlementPriorityChoice	</SttlmPrty>
EndCreditTransferTypeIdentification	</CdtTrfTpId>
Debtor	<Dbtr>
Financial institution	<FI>
BIC	<BIC>AAAACCDDXXX</BIC>
End of financial institution	</FI>
End of debtor	</Dbtr>
First Agent	<FrstAgt>
BIC	<BIC>BANKFRPPXXX</BIC>
End First Agent	</FrstAgt>
Information payment transaction.	<PmtTx>
PaymentIdentification	<PmtId>
InstructionIdentification	<InstrId>ABC1234</InstrId>
EndToEndIdentification	<EndToEndId>ABC1234</EndToEndId>
EndPaymentIdentification	</PmtId>
Amount	<Amt>
InstructedAmount	<InstAmt>12345678.90</InstAmt>
End of Amount	</Amt>
Creditor	<Cdtr>
Financial institution	<FI>
BIC	<BIC>CREDFRPPXXX</BIC>
End of financial institution	</FI>
End of Creditor	</Cdtr>
CreditorAccount	<CdtrAcct>
Simple Identification Information	<DmstAcct>
Identification	<Id>ABC1234</Id>
End of simple Identification Information	</DmstAcct>
EndCreditorAccount	</CdtrAcct>

Final agent	<FnIAgt>
BIC	<BIC>ANCIFRPPMIR</BIC>
End of Final Agent	</FnIAgt>
RemittanceInformation	<RmtInf>
Unstructured	<Ustrd>ABC1234</Ustrd>
EndRemittanceInformation	</RmtInf>
End of Information payment transaction.	</PmtTx>
EndPaymentInformation	</PmtInf>
End of SSP Proprietary Data	</SspPrtryDt>
End of Proprietary Data	</PrtryDt>
End Message Type	</pain.998.001.01>

ASTransferNotice_4

Scope: ASTransferNotice sent by the AS1 to the AS2 (model 6) after a Cross-AS settlement sent by an Interfaced AS1 from a sub-account of Settlement bank A to the Technical account - procedure 6 real-time of the real-time AS2 on behalf of Settlement Bank B (Creditor)
 Counterpart AS = BIC of the Interfaced AS1
 FirstAgent = BIC of a settlement Bank in AS1, DomesticAccount = Sub-account number
 FinalAgent = BIC of the Technical account - procedure 6 real-time of AS2, Creditor = BIC of a Settlement Bank in AS2

Message Type	<pain.998.001.01>
Proprietary Data	<PrtryDt>
Proprietary Data type	<Tp>ASTransferNotice</Tp>
SSP Proprietary Data	<SspPrtryDt>
GroupHeader	<GrpHdr>
GroupIdentification	<Grpld>ABC1234</Grpld>
CreationDateTime	<CreDtTm>2008-10-01T11:30:00</CreDtTm>
ControlSum	<CtrlSum>12345678.90</CtrlSum>
NumberOfTransactions	<NbOfTxs>1</NbOfTxs>
Priority	<Prty>HIGH</Prty>
SettlementModelType	<SttlmMdlTp>6000</SttlmMdlTp>
Counterpart AS	<CtpAS>
Financial institution	<FI>
BIC	<BIC>ANCIATWWXXX</BIC>
End of financial institution	</FI>
End of Counterpart AS	</CtpAS>
EndGroupHeader	</GrpHdr>
PaymentInformation	<PmtInf>
RequestExecutionDate	<ReqdExctnDt>2008-10-01</ReqdExctnDt>
CreditTransferTypeIdentification	<CdtTrfTpId>
SettlementPriorityChoice	<SttlmPrty>
PaymentScheme	<PmtSchme>
Code	<Cd>CDS</Cd>
EndPaymentScheme	</PmtSchme>
EndSettlementPriorityChoice	</SttlmPrty>
EndCreditTransferTypeIdentification	</CdtTrfTpId>
First Agent	<FrstAgt>
BIC	<BIC>BANKATWWXXX</BIC>
End First Agent	</FrstAgt>
FirstAgentAccount	<FrstAgtAcct>
Simple Identification Information	<DmstAcct>
Identification	<Id>AT12345SUBACC01</Id>
End of simple Identification Information	</DmstAcct>
EndFirstAgentAccount	</FrstAgtAcct>
Information payment transaction.	<PmtTx>
PaymentIdentification	<PmtId>
InstructionIdentification	<InstrId>ABC1234</InstrId>
EndToEndIdentification	<EndToEndId>ABC1234</EndToEndId>
EndPaymentIdentification	</PmtId>
Amount	<Amt>
InstructedAmount	<InstAmt>12345678.90</InstAmt>
End of Amount	</Amt>
Creditor	<Cdtr>
Financial institution	<FI>
BIC	<BIC>BANKFRPPXXX</BIC>
End of financial institution	</FI>

End of Creditor	</Cdtr>
Final agent	<FnIAgt>
BIC	<BIC>MIROFRWWAS2</BIC>
End of Final Agent	</FnIAgt>
RemittanceInformation	<RmtInf>
Unstructured	<Ustrd>ABC1234</Ustrd>
EndRemittanceInformation	</RmtInf>
End of Information payment transaction.	</PmtTx>
EndPaymentInformation	</PmtInf>
ResultingBalance	<RsltGBal>
Amount	<Amt>1234789.56</Amt>
Credit or debit indicator	<CdtDbtInd>CRDT</CdtDbtInd>
Value Date / Time	<ValDt>
Date Time	<DtTm>2008-10-01T12:30:00</DtTm>
End of Value Date / Time	</ValDt>
End of ResultingBalance	</RsltGBal>
End of SSP Proprietary Data	</SspPrtryDt>
End of Proprietary Data	</PrtryDt>
End Message Type	</pain.998.001.01>

6. 6. 4 Receipt_ASI

Cash Management Standard

Receipt_ASI

Scope: The Receipt is a Standard Cash Management message (in push mode) that can be
- sent by the ASI to the AS after reception of erroneous ReturnGeneralBusinessInformation or erroneous Receipt (for decision to use Guarantee mechanism)
- sent by GARI to the AS when an AS message is not compliant with the SchemaFile

ASI sends messages in the lowest supported version.

Structure:

message name receipt	<Rct>	
Message Header	<MsgHdr>	M
Message Identification	<MsgId></MsgId>	M
End of Message Header	</MsgHdr>	M
Receipt details	<RctDtls>	
original message ID	<OrgnMsgId>	M
Message Identification	<MsgId></MsgId>	M
End of Original Message ID	</OrgnMsgId>	M
RequestHandling	<ReqHdlg>	
StatusCode	<StsCd></StsCd>	
Description	<Desc></Desc>	
End of Request Handling	</ReqHdlg>	
End of Receipt details	</RctDtls>	
End message name Receipt	</Rct>	

Attributes:

name of attribute	format	short description	description	
<Rct>		message name receipt		
		Mandatory	Validation: [1..1]	
<MsgHdr>		Message Header	Set of characteristics specific to the message	M
		Mandatory	Validation: [1..1]	
<MsgId></MsgId>	35x	Message Identification	Message Identification Reference assigned by the sender (GARI or ASI) to unambiguously identify the Receipt message.	M
		Mandatory	Validation: [1..1]	
</MsgHdr>		End of Message Header		M
		Mandatory	Validation: [1..1]	
<RctDtls>		Receipt details		
		Mandatory	Validation: [1..n]	
<OrgnMsgId>		original message ID	Additional Reference Reference to the task, generated by SSP module Reference to the task, generated by SSP module	M
		Mandatory	Validation: [1..1]	
<MsgId></MsgId>	16x	Message Identification	String of characters that uniquely identifies a message Reference of the original message received by the SSP	M
		Mandatory	Validation: [1..1]	
</OrgnMsgId>		End of Original Message ID	End of Original Message ID	M
		Mandatory	Validation: [1..1]	
<ReqHdlg>		RequestHandling	Gives the status of the request. StatusCode Description	
		Mandatory	Validation: [1..1]	
<StsCd></StsCd>	4!x	StatusCode	The code depends on which kind of order is followed by the Receipt: -Reception of erroneous message : The error will be indicated by the StatusCode (sent by GARI or ASI) GARI codes are : 1101 - an application header must be sent with each message 1102 - The payload must not be empty 1199 - Parser exception	
		Mandatory	Validation: [1..1]	
<Desc></Desc>	140x	Description	- Describes the current state of the AS in Model 6, in case of response by ASI to an erroneous	

name of attribute	format	short description	description
		Optional	ReturnGeneralBusinessInformation - Describes the location and the reason of the error detected by GARI Validation: [0..1]
</ReqHdlg>		End of Request Handling Mandatory	End of Request Handling Validation: [1..1]
</RctDtls>		End of Receipt details Mandatory	Validation: [1..n]
</Rct>		End message name Receipt Mandatory	Validation: [1..1]

Error Codes:

Receipt_ASI_1

Scope: This sample of receipt is sent by the ASI to the AS upon reception of an erroneous ReturnGeneralBusinessInformation related to the control of the AS phases. In particular, the error can come from the fact that the phase requested is out of the sequence start of procedure -> (start of cycle -> end of cycle) 0 to n times -> end of procedure. The StatusCode mentions the associated error code and the Description indicates the current state of the AS phase (here: daylight procedure open)

message name receipt	<Rct>	
Message Header	<MsgHdr>	M
Message Identification	<MsgId>ABC1234</MsgId>	M
End of Message Header	</MsgHdr>	M
Receipt details	<RctDtIs>	M
original message ID	<OrgnIMsgId>	M
Message Identification	<MsgId>ABCD</MsgId>	M
End of Original Message ID	</OrgnIMsgId>	M
RequestHandling	<ReqHdlg>	
StatusCode	<StsCd>A034</StsCd>	
Description	<Desc>PROC DAYLIGHT: Open</Desc>	
End of Request Handling	</ReqHdlg>	
End of Receipt details	</RctDtIs>	
End message name Receipt	</Rct>	

Receipt_ASI_2

Scope: This Receipt is sent by the ASI to reject the Receipt sent by the AS for a decision to use the Guarantee mechanism which is different from "YES" or "NO" (Error A032: Invalid StatusCode)

message name receipt	<Rct>	
Message Header	<MsgHdr>	M
Message Identification	<MsgId>123456789ABCD</MsgId>	M
End of Message Header	</MsgHdr>	M
Receipt details	<RctDtls>	
original message ID	<OrgnlMsgId>	M
Message Identification	<MsgId>RCPT20071031001</MsgId>	M
End of Original Message ID	</OrgnlMsgId>	M
RequestHandling	<ReqHdlg>	
StatusCode	<StsCd>A032</StsCd>	
End of Request Handling	</ReqHdlg>	
End of Receipt details	</RctDtls>	
End message name Receipt	</Rct>	

Receipt_ASI_3

Scope: This sample of receipt is sent by GARI to the AS upon reception of an AS message not compliant with the SchemaFile. The StatusCode mentions the associated error code and the Description indicates the location and reason of the detected error.

message name receipt	<Rct>	
Message Header	<MsgHdr>	M
Message Identification	<MsgId>8a8c81dc759e2ff00d3</MsgId>	M
End of Message Header	</MsgHdr>	M
Receipt details	<RctDtIs>	
original message ID	<OrgnMsgId>	M
Message Identification	<MsgId>NL070109</MsgId>	M
End of Original Message ID	</OrgnMsgId>	M
RequestHandling	<ReqHdlg>	
StatusCode	<StsCd>1199</StsCd>	
Description	<Desc>Error validating document: line: 23 column: 36 reason: "foto" does not satisfy boolean </Desc>	
End of Request Handling	</ReqHdlg>	
End of Receipt details	</RctDtIs>	
End message name Receipt	</Rct>	

6. 6. 5 Receipt_AS

Cash Management Standard

Receipt_AS

M

Scope: The Receipt is a Standard Cash Management message that can be sent by the AS (or by the CB on behalf) to the ASI (in pull mode) on Reception of ASInitiationStatus with the DecisionIndicator filled with "true" (possibility to use the Guarantee Mechanism). The StatusCode of the receipt will indicate the positive "YES" or negative "NO" decision. AS can send the message in 2 different versions. The ASI response will be always in the lowest supported version, <camt.025.001.xx>

Structure:

message name receipt	<Rct>
Message Header	<MsgHdr>
Message Identification	<MsgId></MsgId>
End of Message Header	</MsgHdr>
Receipt details	<RctDtls>
original message ID	<OrgnMsgId>
Message Identification	<MsgId></MsgId>
End of Original Message ID	</OrgnMsgId>
RequestHandling	<ReqHdlg>
StatusCode	<StsCd></StsCd>
Description	<Desc></Desc>
End of Request Handling	</ReqHdlg>
End of Receipt details	</RctDtls>
End message name Receipt	</Rct>

Attributes:

name of attribute	format	short description	description
<Rct>		message name receipt Mandatory A2A	Validation:
<MsgHdr>		Message Header Mandatory A2A	Set of characteristics specific to the message Validation: [1..1]
<MsgId>-</MsgId>	35x	Message Identification Mandatory A2A	Message Identification Validation: [1..1]
</MsgHdr>		End of Message Header Mandatory A2A	Validation: [1..1]
<RctDtls>		Receipt details Mandatory A2A	Validation: ****[1..1] differs from the Cash Management Standard. Only the first occurrence of Receipt details will be used.
<OrgnMsgId>		original message ID Mandatory A2A	Additional Reference Reference to the task, generated by SSP module Validation: [1..1]
<MsgId>-</MsgId>	16x	Message Identification Mandatory A2A	String of characters that uniquely identifies a message Validation: [1..1] GroupIdentification of the original message for which an ASInitiationStatus with DecisionIndicator is received by the AS
</OrgnMsgId>		End of Original Message ID Mandatory A2A	End of Original Message ID Validation: [1..1]
<ReqHdlg>		RequestHandling Mandatory A2A	RequestHandling Gives the status of the request. StatusCode Description Validation: ****[1..1] differs from the Cash Management Standard. Element is mandatory for SSP.
<StsCd>-</StsCd>	4!x	StatusCode Mandatory	Error Codes specified by ASI The code depends on which kind of order is followed by the Receipt: -Reception of ASInitiationStatus when the DecisionIndicator is filled with "True" to give the possibility to use the Guarantee Mechanism: The StatusCode of the receipt will indicate the decision - positive ("YES") or negative ("NO") - to use the Guarantee mechanism. Validation:

name of attribute	format	short description	description
		A2A	[1..1]
<Desc>-</Desc>	140x	Description	If the sender is a CB or the OT, then this field must be filled with the BIC of the AS relative to the ASInitiationStatus received. If the sender is the AS then this field will be ignored.
		Optional	Validation: [0..1]
</ReqHdlg>		End of Request Handling	End of RequestHandling
		Mandatory	Validation: *****[1..1]
		A2A	
</RctDtIs>		End of Receipt details	
		Mandatory	Validation: *****[1..1]
		A2A	
</Rct>		End message name Receipt	
		Mandatory	Validation:
		A2A	

Error Codes:

Order	Error code				Error Text / Validation/ Remark
	SSP	Y-copy	V-shape	XML	
	A02			A002	Error Text: AS missing or not allowed in InitiatingParty / SubjectDetails Validation: The AS must be in the list delivered to ASI by Static data / If Description tag is filled, it must contain the BIC of the AS relative to the ASInitiationStatus received. Remark:
	A30			A030	Error Text: Code unknown Validation: The code must be "YES" or "NO" Remark:
	862	C2	TM01	2862	Error Text: Request out of cut-off time Validation: The request must be sent during the operating time of the ASI Remark:
1	A01			A001	Error Text: Sender not allowed Validation: The sending DN is not that of an AS Remark:
2	A20			A020	Error Text: Double payment identification Validation: The Reference assigned by the AS to unambiguously identify the Receipt message must be unique for a single AS and for a period of 5 business days Remark:
3	A31			A031	Error Text: Reference unknown Validation: The Reference tag must contain the GroupIdentification reference of the original message for which an ASInitiationStatus is received by the AS Remark:
4	A32			A032	Error Text: Invalid StatusCode Validation: The possible values are "YES" or "NO" Remark:
5	A02			A002	Error Text: AS missing or not allowed in InitiatingParty / SubjectDetails Validation: If the sender is a CB, then this field must be filled with the BIC of the AS relative to the ASInitiationStatus received Remark:

Receipt_AS_1

Scope: This sample of Receipt is sent by the AS to the ASI on reception of ASInitiationStatus with the DecisionIndicator filled with "True" (possibility to use the Guarantee Mechanism). The StatusCode is used by the AS to indicate whether it wants to have recourse to the guarantee mechanism. In this sample the value of StatusCode is "YES" which means that the AS wants to have recourse to the guarantee mechanism. Otherwise the AS should indicate "NO".

message name receipt	<Rct>
Message Header	<MsgHdr>
Message Identification	<MsgId>ABCD1234</MsgId>
End of Message Header	</MsgHdr>
Receipt details	<RctDtIs>
original message ID	<OrgnlMsgId>
Message Identification	<MsgId>ABCD</MsgId>
End of Original Message ID	</OrgnlMsgId>
RequestHandling	<ReqHdlg>
StatusCode	<StsCd>YES</StsCd>
End of Request Handling	</ReqHdlg>
End of Receipt details	</RctDtIs>
End message name Receipt	</Rct>

6. 6. 6 ReturnAccount_ASI

Cash Management Standard

ReturnAccount_ASI

Scope: The ReturnAccount is a Standard Cash Management (version 4.0) sent by the ASI in push mode to the AS in model 6 to notify the transfers of liquidity and the funds booked on the sub-accounts.

This message is also sent by the ASI to the real-time AS to notify the global amount blocked on the Technical account - procedure 6 real-time.

Use of ReturnAccount for Interfaced models:

For sub-accounts :

a) The ReturnAccount contains only the AccountReport for the Settlement Banks whose sub-account has been debited or credited in the previous operation : current order, connected payment, increase/decrease of liquidity from CB. Both of the MultilateralBalances are indicated ("PYMT" and "BOOK").

b) Following a Start of procedure or Start of cycle, the ReturnAccount contains the AccountReport for all the Settlement Banks which have a sub-account dedicated to the AS :

- If the amount on the sub-account is zero, there is no MultilateralBalance
- If the amount on the sub-account is different of zero, there is only the MultilateralBalance "BOOK"

c) Following a request of End of Procedure, the ReturnAccount contains the AccountReport for all the Settlement Banks which have a sub-account dedicated to the AS :

- if there was no back transfer of liquidity, there is no MultilateralBalance
- if there was a back transfer of liquidity, there is only the MultilateralBalance "PYMT" which indicates the transferred amount.

For main accounts:

Following an automatic increase of liquidity by specific transactions (ie coupons and redemption), the ReturnAccount contains only the AccountReport for the Settlement Banks whose main account has been credited. Only the MultilateralBalance "PYMT" is indicated.

Use of ReturnAccount for real-time Models:

The ReturnAccount is sent by ASI to notify to the AS the global amount on the Technical account - procedure 6 real-time after execution of the Start of cycle. (code "BOOK").:

- First cycle: Liquidity from standing orders and current orders executed since the Start of procedure
- Following cycles: Liquidity from current orders executed since the last End of cycle

Use of ReturnAccount in case of Cross-AS settlement:

The ReturnAccount is also sent to the AS (Interfaced or real-time) to notify the liquidity debited on the sub-account or the Technical account - procedure 6 real-time, during the cycle, to settle a Cross-AS settlement sent by the CB on behalf of this AS.

The occurrence MultilateralBalance is used to indicate:

- The amount which has been decreased from the account (mirror or sub-account)
- The new balance on this account

ASI sends messages in the lowest supported version
<camt.004.001.xx>

Structure:

MessageName of ReturnAccount	<RtrAcct>
Message Identification	<MsgId>
Message business identification	<Id></Id>
End Message Identification	</MsgId>
BusinessReport	<BizRpt>
AccountReport	<AcctRpt>
Account Identification	<AcctId>
Simple Identification Information	<DmstAcct>
Identification	<Id></Id>
End of simple Identification Information	</DmstAcct>
End of Account Identification	</AcctId>
Account Identification	<Acct>
Proprietary Data type	<Tp></Tp>
BICIdentifier	<AcctOwnr></AcctOwnr>
MultilateralBalance	<MulBal>
Amount	<Amt></Amt>
Credit or debit indicator	<CdtDbtInd></CdtDbtInd>
BalanceTypeCode	<Tp>
BalanceTypeCode	<Cd></Cd>

End of BalanceTypeCode					</Tp>
Value Date / Time					<ValDt>
Date Time					<DtTm></DtTm>
End of Value Date / Time					</ValDt>
End of MultilateralBalance					</MulBal>
End of Account					</Acct>
End of AccountReport					</AcctRpt>
End of BusinessReport					</BizRpt>
End of Messagname of ReturnAccount					</RtrAcct>

Attributes:

name of attribute	format	short description	description
<RtrAcct>		Message name of ReturnAccount Mandatory	Message name of ReturnAccount Validation: [1..1]
<MsgId>		Message Identification Mandatory	Message business identification Unique and unambiguous identifier for a message, as assigned by the Sender. This unique identifier can be used for cross-referencing purposes in subsequent messages. Validation: [1..1]
<Id>-</Id>	35x	Message business identification Mandatory	=Reference assigned by the ASI to identify the message The format is composed of 6 characters followed by the PM business case identification. The triggering event of the ReturnAccount is precised by the first 6 characters which are : DAYSOP : Start of Procedure Daylight OVNSOC : Start of Cycle in Night-time DAYSOC : Start of Cycle in Daylight OVNEOP : Back transfer of liquidity at end of Night-time procedure DAYEOP : Back transfer of liquidity at end of Daylight procedure OVNSOP : Start of procedure Night-time (execution of standing orders) SBKLCT : LiquidityCreditTransfer sent by Settlement Bank through ICM SBKFIN : FIN MT202 sent by Settlement Bank CBMAN : Mandated payment CBKCSP : Connected payment sent by CB CBKCHA : Autocollateralisation "CHA" sent by CB CBKREP : Autocollateralisation "REP" sent by CB CBKSTR : Specific Transactions "STR" sent by CB CBKCOL : Autocollateralisation "COL" sent by CB CBKCDS: Cross-AS settlement by CB Validation: [1..1]
</MsgId>		End Message Identification Mandatory	Validation: [1..1]
<BizRpt>		BusinessReport Mandatory	BusinessReport Choice used by the ASI Validation: [1..1]
<AcctRpt>		AccountReport Mandatory	This occurrence is unique in case of real-time models This occurrence could be repeated for each sub-account number linked to the receiver in case of interfaced Validation: [1..n]
<AcctId>		Account Identification Mandatory	Account Identification Validation: [1..1]
<DmstAcct>		Simple Identification Information	Simple Identification Information Domestic Account Account number used by financial institutions in individual countries to identify an account of a customer, but

name of attribute	format	short description	description
		Mandatory	necessarily the bank and branch of the financial institution in which the account is held. Validation: [1..1]
<Id>-</Id>	35x	Identification Mandatory	Identification of an entity Interfaced models = Main account or Sub-account number of the Settlement Bank Real-time models = Bic of the Technical account - procedure 6 real-time Validation: [1..1]
</DmstAcct>		End of simple Identification Information Mandatory	Validation: [1..1]
</AcctId>		End of Account Identification Mandatory	Unique and unambiguous identification for the account between the account owner and the account servicer. Validation: [1..1]
<Acct>		Account Identification Mandatory	Validation: [1..1]
<Tp>-</Tp>		Proprietary Data type Optional	Account used for settlement : "SACC" Validation: [0..1]
<AcctOwnc>-</AcctOwnc>		BICIdentifier Optional	Interfaced models = BIC of the Settlement Bank Real-time models = Not used Validation: [0..1]
<MulBal>		MultilateralBalance Optional	The "PYMT" occurrence contains the increased or decreased amount, the "BOOK" occurrence contains the new balance Validation: [0..n]
<Amt>-</Amt>	18d	Amount Mandatory	"PYMT" occurrence = Individual amount of operation. "BOOK" occurrence = New balance in the sub account or Technical account - procedure 6 real-time Validation: [1..1]
<CdtDbtInd>-</CdtDbtInd>	4!a	Credit or debit indicator	-if applied to a balance, indicates whether the balance is a credit or a debit balance. CRDT = Credit Balance is a credit balance. DBIT = Debit Balance is a debit balance. A zero balance is considered to be a credit balance -if applied to an operation, indicates whether it is a debit or a credit operation, CRDT = Credit

name of attribute	format	short description	description
			<p>Operation is an increase.</p> <p>DBIT = Debit Operation is a decrease.</p> <p>A zero amount is considered to be a credit operation</p> <p>Interfaced models = Indicates whether the amount increases ("CRDT"), or decreases ("DBIT") the sub-account. A zero amount is considered to be a credit amount</p> <p>Interfaced and real-time models = Indicates whether the balance is a credit or a debit balance. A zero balance is considered to be a credit balance</p> <p>Mandatory</p> <p>Validation: [1..1] Values : "CRDT", "DBIT"</p>

<Tp>	BalanceTypeCode	Type
		<p>ADJT Adjustment Balance to be held in the settlement account in order to comply with the average reserve due, in the event that the bank's balance is equal to the reserve due during the remaining days of the maintenance period.</p> <p>AVLB Available Balance of money or securities that is at the disposal of the account owner on the date specified.</p> <p>BLCK Blocked Balance representing the regulatory reserve that a financial institution must have with the account servicing institution, eg, the minimum credit balance a financial institution is to keep with its Central Bank for mandatory reserve purposes. In some countries, a blocked balance is known as a 'reserve' balance.</p> <p>BOOK Book Balance that is registered in the books of the account servicer.</p> <p>CLSG Closing Balance of the account at the end of the account servicer's business day. It is the sum of the opening balance at the beginning of the day and all entries booked to the account during the account servicer's business day.</p> <p>CRDT Credit Balance representing the sum of all credit entries booked to an account.</p> <p>CRRT Current Balance of the account at a precise moment in time.</p> <p>DBIT Debit Balance representing the sum of all debit entries booked to an account.</p> <p>DLOD DaylightOverdraft Balance representing the intra day overdraft granted by the Central Bank to financial institutions participating in a RTGS system. This balance may vary over time and shall be offset at the end of the day.</p> <p>EAST EligibleAssets Balance representing the potential loan a Central Bank would make in cash if the collateral is pledged, eg, securities available and eligible as collateral with the Central Bank.</p> <p>INTM Interim Balance calculated in the course of the account servicer's business day, at the time specified, and subject to further changes during the business day. The interim balance is calculated on the basis of booked credit and debit items during the calculation time/period specified.</p>

name of attribute	format	short description	description
			<p>LRLD LimitRelated Balance of a specific limit value, eg, a bilateral balance is calculated in relation to a given bilateral limit.</p> <p>LTSF LiquidityTransfer Balance composed of the sum of all liquidity transfers made to or from an account.</p> <p>OPNG Opening Book balance of the account at the beginning of the account servicer's business day. It always equals the closing book balance from the previous business day. Note: the available balance at the beginning of the account servicer's business day may be different from the closing book balance from the previous business day.</p> <p>PDNG Pending Balance of securities pending delivery, eg, orders to sell securities have been executed but settlement of the open transactions has not been confirmed.</p> <p>PRAV ProgressiveAverage Average of the daily balances on the account used to fulfil the reserve requirements calculated from the beginning of the maintenance period.</p> <p>PYMT Payment Balance representing the sum of entries as a result of payments processing. Entries relating to fees, interest, or other movements not a result of payments sent or received by the account owner are not included.</p> <p>XCRD ExpectedCredit Balance, composed of booked entries and pending items known at the time of calculation, which projects the end of day credit balance if everything books to the account and no other credit entry is posted.</p> <p>XDBT ExpectedDebit Balance, composed of booked entries and pending items known at the time of calculation, which projects the end of day debit balance if everything books to the account and no other debit entry is posted.</p> <p>XPCD Expected Balance, composed of booked entries and pending items known at the time of calculation, which projects the end of day balance if everything is booked on the account and no other entry is posted.</p> <p>The increase or decrease amount is identified by the type "PYMT" The new balance is identified by the type "BOOK"</p>
		Optional	Validation: [0..1]
<Cd>-</Cd>		BalanceTypeCode	Specifies the nature of the balance
		Mandatory	Validation: [1..1]
</Tp>		End of BalanceTypeCode	Specifies the nature of the balance
		Optional	Validation: [0..1]
<ValDt>		Value Date / Time	Date and time assets become available to the account owner (in a credit entry), or cease to be available to the account owner (in a debit entry).
		Optional	Date / Time at which the amount is or will be available Validation: [0..1]
<DtM>-</DtM>	ISODateTime	Date Time	Settlement time stamp. The date and time must be

name of attribute	format	short description	description
		Mandatory	considered separately because : Date = Business date Time = System time Validation: [1..1]
</ValDt>		End of Value Date / Time Optional	Validation: [0..1]
</MulBal>		End of MultilateralBalance Optional	Validation: [0..n]
</Acct>		End of Account Mandatory	End of Account Validation: [1..1]
</AcctRpt>		End of AccountReport Mandatory	End of AccountReport Validation: [1..n][1.1]
</BizRpt>		End of BusinessReport Mandatory	Validation: [1..1]
</RtrAcct>		End of Messagname of ReturnAccount Mandatory	end of Messagname of ReturnAccount Validation: [1..1]

Error Codes:

ReturnAccount_AS_1

Scope: This sample of ReturnAccount is sent to AS in real-time models after execution of the Start of Cycle

The AccountReport occurrence is used as single.

The occurrence MultilateralBalance indicates the new balance on the Technical account - procedure 6 real-time (code "BOOK")

MessageName of ReturnAccount	<RtrAcct>
Message Identification	<MsgId>
Message business identification	<Id>OVNSOC123ABC1234</Id>
End Message Identification	</MsgId>
BusinessReport	<BizRpt>
AccountReport	<AcctRpt>
Account Identification	<AcctId>
Simple Identification Information	<DmstAcct>
Identification	<Id>BDFEFRPPMIR</Id>
End of simple Identification Information	</DmstAcct>
End of Account Identification	</AcctId>
Account Identification	<Acct>
Proprietary Data type	<Tp>SACC</Tp>
MultilateralBalance	<MulBal>
Amount	<Amt>1234.56</Amt>
Credit or debit indicator	<CdtDbtInd>CRDT</CdtDbtInd>
BalanceTypeCode	<Tp>
BalanceTypeCode	<Cd>BOOK</Cd>
End of BalanceTypeCode	</Tp>
Value Date / Time	<ValDt>
Date Time	<DtTm>2007-01-01T09:00:00</DtTm>
End of Value Date / Time	</ValDt>
End of MultilateralBalance	</MulBal>
End of Account	</Acct>
End of AccountReport	</AcctRpt>
End of BusinessReport	</BizRpt>
End of MessageName of ReturnAccount	</RtrAcct>

ReturnAccount_AS_2

Scope: The ReturnAccount is a Standard Cash Management sent by the ASI to the AS in model 6 to notify the transfers of liquidity and the funds booked on the sub-accounts.

Messagename of ReturnAccount	<RtrAcct>
Message Identification	<MsgId>
Message business identification	<Id>CBKCHA987ABC1234</Id>
End Message Identification	</MsgId>
BusinessReport	<BizRpt>
AccountReport	<AcctRpt>
Account Identification	<AcctId>
Simple Identification Information	<DmstAcct>
Identification	<Id>FR9999ABC01</Id>
End of simple Identification Information	</DmstAcct>
End of Account Identification	</AcctId>
Account Identification	<Acct>
Proprietary Data type	<Tp>SACC</Tp>
BICIdentifier	<AcctOwnr>BANKFRPPXXX</AcctOwnr>
MultilateralBalance	<MulBal>
Amount	<Amt>1234.56</Amt>
Credit or debit indicator	<CdtDbtInd>CRDT</CdtDbtInd>
BalanceTypeCode	<Tp>
BalanceTypeCode	<Cd>PYMT</Cd>
End of BalanceTypeCode	</Tp>
Value Date / Time	<ValDt>
Date Time	<DtTm>2007-01-01T09:00:00</DtTm>
End of Value Date / Time	</ValDt>
End of MultilateralBalance	</MulBal>
MultilateralBalance	<MulBal>
Amount	<Amt>1234789.56</Amt>
Credit or debit indicator	<CdtDbtInd>CRDT</CdtDbtInd>
BalanceTypeCode	<Tp>
BalanceTypeCode	<Cd>BOOK</Cd>
End of BalanceTypeCode	</Tp>
Value Date / Time	<ValDt>
Date Time	<DtTm>2007-01-01T09:00:00</DtTm>
End of Value Date / Time	</ValDt>
End of MultilateralBalance	</MulBal>
End of Account	</Acct>
End of AccountReport	</AcctRpt>
End of BusinessReport	</BizRpt>
End of Messagename of ReturnAccount	</RtrAcct>

6. 6. 7 ReturnGeneralBusinessInformation_AS

Cash Management Standard

ReturnGeneralBusinessInformation_AS

M

Scope: This message is a Standard Cash Management sent by the AS to order the start and the end of procedures and cycles. AS can send the message in 2 different versions. The ASI response will be always in the lowest supported version, <camt.021.001.xx>

Structure:

Message Type	<RtrGnlBizInf>
Message Header	<MsgHdr>
Message Identification	<MsgId></MsgId>
End of Message Header	</MsgHdr>
BusinessReportOrErrorChoice	<RptOrErr>
BusinessReport	<BizRpt>
BusinessInformationReference	<BizInfRef></BizInfRef>
GeneralBusinessOrErrorChoice	<GnlBizOrErr>
GeneralBusinessInformation	<GnlBiz>
Qualifier	<Qlfr>
Isformatted	<IsFrmtd></IsFrmtd>
End of Qualifier	</Qlfr>
Subject	<Sbjt></Sbjt>
BIC	<SbjtDtls></SbjtDtls>
End of GeneralBusinessInformation	</GnlBiz>
End of GeneralBusinessOrErrorChoice	</GnlBizOrErr>
End of BusinessReport	</BizRpt>
End of BusinessReportOrErrorChoice	</RptOrErr>
End of Message Type	</RtrGnlBizInf>

Attributes:

name of attribute	format	short description	description
<RtrGnlBizInf>		Message Type	Message Type of ReturnGeneralBusinessInformation
		Mandatory	Validation: [1..1]
<MsgHdr>		Message Header	Set of characteristics specific to the message
		Mandatory	Validation: [1..1]
<MsgId>--</MsgId>	35x	Message Identification	Message Identification
		Mandatory	Validation: [1..1]
</MsgHdr>		End of Message Header	
		Mandatory	Validation: [1..1]
<RptOrErr>		BusinessReportOrErrorChoice	
		Optional	Validation:
<BizRpt>		BusinessReport	BusinessReport This choice must be used
		Mandatory	Validation: [1..1]
<BizInfRef>--</BizInfRef>	16x	BusinessInformationReference	Unique and unambiguous identification of a general business information system, as assigned by the system transaction administrator. On a notification of release of liquidity sent by the ASI, this reference is the copy of the BusinessInformationReference contained in the ReturnGeneralBusinessInformation sent by the AS or the CB to request the End of Cycle. /.maxLength = 16 /.minLength = 1 Unique and unambiguous identification.
		Mandatory	Validation: [1..1] The contents must comply with the FIN set of characters and must not contain slashes.
<GnlBizOrErr>		GeneralBusinessOrErrorChoice	GeneralBusinessOrErrorChoice
		Mandatory	Validation: [1..1]
<GnlBiz>		GeneralBusinessInformation	GeneralBusinessInformation This choice must be used
		Mandatory	Validation: [1..1]
<Qlfr>		Qualifier	
		Optional	Validation: [0..1] Mandatory when the AS or the CB is the sender. Optional when the SSP is the sender
<IsFrmtd>--</IsFrmtd>	YES/NO	Isformatted	
		Optional	Validation: [0..1] Mandatory when the AS or the CB is the sender.

name of attribute	format	short description	description
			In that case the only possible value is "true". Optional when the SSP is the sender.
</Qlfr>		End of Qualifier Optional	End of Qualifier Validation: [0..1]
<Sbjt>-</Sbjt>	35x	Subject Optional	Notification code: Codes sent by the ASI: OVN-PROC-OPN = Overnight Procedure is open LIQ-CYCL-END = Release of liquidity after End of Cycle OVN-PROC-CLOS = Night-time procedure is closed (real-time AS) DAY-PROC-CLOS = Day time procedure is closed (real-time AS) Codes sent by the AS: OVN-CYCL-OPEN = Open Overnight Cycle OVN-CYCL-CLOS = Close Overnight Cycle OVN-PROC-CLOS = Close Overnight Procedure DAY-PROC-OPEN = Open Daylight Procedure DAY-CYCL-OPEN = Open Daylight Cycle (Interfaced AS only) DAY-CYCL-CLOS = Close Daylight Cycle (Interfaced AS only) DAY-PROC-CLOS = Close Daylight Procedure NB : When the night-time procedure is closed, a daylight procedure can be open during the night-time trade phase Validation: [0..1]
<SbjtDtls>-</SbjtDtls>	11x	BIC Optional	If the sender is a CB on behalf of the AS, this field is filled with the BIC of the AS Validation: [0..1]
</GnlBiz>		End of GeneralBusinessInformation Mandatory	End of GeneralBusinessInformation Validation: [1..1]
</GnlBizOrErr>		End of GeneralBusinessOrErrorChoice Mandatory	End of GeneralBusinessOrErrorChoice Validation: [1..1]
</BizRpt>		End of BusinessReport Mandatory	End of BusinessReport Validation: [1..1]
</RptOrErr>		End of BusinessReportOrErrorChoice Mandatory	Validation: [1..1]
</RtrGnlBizInf>		End of Message Type Mandatory	End of Message Type of ReturnGeneralBusinessInformation Validation: [1..1]

Error Codes:

Order	Error code				Error Text / Validation/ Remark
	SSP	Y-copy	V-shape	XML	
	862	C2	TM01	2862	Error Text: Request out of cut-off time Validation: The request must be sent during the operating time of the ASI Remark:
1	A01			A001	Error Text: Sender not allowed Validation: The sender must be an AS or a CB defined in Static Data Remark:
2	A02			A002	Error Text: AS missing or not allowed in InitiatingParty / SubjectDetails Validation: When the DN is relative to a CB, then the Tag <SbjtDtls> must be filled with the BIC of an AS of which this CB is responsible. Remark:
3	A20			A020	Error Text: Double payment identification Validation: BIC (11 characters) of the sender of the message + <Id> in <MsgId> must be unique over a period of 5 business days Remark:
4	A20			A020	Error Text: Double payment identification Validation: BIC (11 characters) of the sender of the message + <BizInfRef> must be unique over one business day Remark:
6	A29			A029	Error Text: The qualifier must be Formatted Validation: Indicator <IsFrmtd> must be filled with "true" Remark:
7	A30			A030	Error Text: Code unknown Validation: <Sbjt> must belong in the following list: OVN-CYCL-OPEN, OVN-CYCL-CLOS, OVN-PROC-CLOS, DAY-PROC-OPEN, DAY-CYCL-OPEN, DAY-CYCL-CLOS, DAY-PROC-CLOS Remark:
8	A34			A034	Error Text: Order or message out of sequence Validation: The code specified in <Sbjt> must be consistent with the actual phase of AS business. Remark:

ReturnGeneralBusinessInformation_AS_1

Scope: ReturnGeneralBusinessInformation message used by the AS to order the start and end of procedures and cycles, This message could also be used by the CB on behalf of the AS, in this case the BIC of the AS must be filled in "SubjectDetails"

Message Type	<RtrGnlBizInf>
Message Header	<MsgHdr>
Message Identification	<MsgId>ABC1234</MsgId>
End of Message Header	</MsgHdr>
BusinessReportOrErrorChoice	<RptOrErr>
BusinessReport	<BizRpt>
BusinessInformationReference	<BizInfRef>ABC1234</BizInfRef>
GeneralBusinessOrErrorChoice	<GnlBizOrErr>
GeneralBusinessInformation	<GnlBiz>
Qualifier	<Qlfr>
Isformatted	<IsFrmtd>true</IsFrmtd>
End of Qualifier	</Qlfr>
Subject	<Sbjt>OVN-CYCL-OPEN</Sbjt>
End of GeneralBusinessInformation	</GnlBiz>
End of GeneralBusinessOrErrorChoice	</GnlBizOrErr>
End of BusinessReport	</BizRpt>
End of BusinessReportOrErrorChoice	</RptOrErr>
End of Message Type	</RtrGnlBizInf>

ReturnGeneralBusinessInformation_AS_1b

Scope: ReturnGeneralBusinessInformation message used by the CB on behalf of the AS to order the start and end of procedures and cycles,
The BIC of the AS must be filled in "SubjectDetails"

Message Type	<RtrGnlBizInf>
Message Header	<MsgHdr>
Message Identification	<MsgId>ABC1234</MsgId>
End of Message Header	</MsgHdr>
BusinessReportOrErrorChoice	<RptOrErr>
BusinessReport	<BizRpt>
BusinessInformationReference	<BizInfRef>ABC1234</BizInfRef>
GeneralBusinessOrErrorChoice	<GnlBizOrErr>
GeneralBusinessInformation	<GnlBiz>
Qualifier	<Qlfr>
Isformatted	<IsFrmtd>>true</IsFrmtd>
End of Qualifier	</Qlfr>
Subject	<Sbjt>OVN-CYCL-CLOS</Sbjt>
BIC	<SbjtDtls>ANCILU2L123</SbjtDtls>
End of GeneralBusinessInformation	</GnlBiz>
End of GeneralBusinessOrErrorChoice	</GnlBizOrErr>
End of BusinessReport	</BizRpt>
End of BusinessReportOrErrorChoice	</RptOrErr>
End of Message Type	</RtrGnlBizInf>

6. 6. 8 ReturnGeneralBusinessInformation_ASI

Cash Management Standard

ReturnGeneralBusinessInformation_ASI

Scope: This message is a Standard Cash Management sent by the ASI to notify the orders received from the AS. ASI sends messages in the lowest supported version <camt.021.001.xx>

Structure:

Message Type	<RtrGnlBizInf>
Message Identification	<MsgId>
Message business identification	<Id></Id>
End Message Identification	</MsgId>
BusinessReport	<BizRpt>
GeneralBusinessReport	<GnlBizRpt>
BusinessInformationReference	<BizInfRef></BizInfRef>
GeneralBusinessInformation	<GnlBizInf>
Qualifier	<Qlfr>
Isformatted	<IsFrmtd></IsFrmtd>
End of Qualifier	</Qlfr>
Subject	<Sbjt></Sbjt>
BIC	<SbjtDtls></SbjtDtls>
End of GeneralBusinessInformation	</GnlBizInf>
End of GeneralBusinessReport	</GnlBizRpt>
End of BusinessReport	</BizRpt>
End of Message Type	</RtrGnlBizInf>

Attributes:

name of attribute	format	short description	description
<RtrGnlBizInf>		Message Type	Message Type of ReturnGeneralBusinessInformation
		Mandatory	Validation: [1..1]
<MsgId>		Message Identification	Message business identification
		Mandatory	Unique and unambiguous identifier for a message, as assigned by the Sender. This unique identifier can be used for cross-referencing purposes in subsequent messages. Validation: [1..1]
<Id>-</Id>	35x	Message business identification	
		Mandatory	Validation: [1..1]
</MsgId>		End Message Identification	
		Mandatory	Validation: [1..1]
<BizRpt>		BusinessReport	BusinessReport
		Mandatory	This choice must be used Validation: [1..1]
<GnlBizRpt>		GeneralBusinessReport	Reports either on the business information or on a business error.
		Mandatory	Validation: [1..n]
<BizInfRef>-</BizInfRef>	16x	BusinessInformationReference	Unique and unambiguous identification of a general business information system, as assigned by the system transaction administrator.
		Mandatory	On a notification of release of liquidity sent by the ASI, this reference is the copy of the BusinessInformationReference contained in the ReturnGeneralBusinessInformation sent by the AS or the CB to request the End of Cycle. /.maxLength = 16 /.minLength = 1 Unique and unambiguous identification. Validation: [1..1] The contents must comply with the FIN set of characters and must not contain slashes.
<GnlBizInf>		GeneralBusinessInformation	The requested business information.
		Mandatory	This choice must be used Validation: [1..1]
<Qlfr>		Qualifier	
		Optional	Validation: [0..1] Mandatory when the AS or the CB is the sender. Optional when the SSP is the sender
<IsFrmted>-</IsFrmted>	YES/NO	Isformatted	
		Optional	Validation:

name of attribute	format	short description	description
			[0..1] Mandatory when the AS or the CB is the sender. In that case the only possible value is "true". Optional when the SSP is the sender.
</Qlfr>		End of Qualifier	End of Qualifier
		Optional	Validation: [0..1]
<Sbjt>-</Sbjt>	35x	Subject	Notification code: Codes sent by the ASI: OVN-PROC-OPN = Overnight Procedure is open LIQ-CYCL-END = Release of liquidity after End of Cycle Codes sent by the AS: OVN-CYCL-OPEN = Open Overnight Cycle OVN-CYCL-CLOS = Close Overnight Cycle OVN-PROC-CLOS = Close Overnight Procedure (Interfaced AS only) DAY-PROC-OPEN = Open Daylight Procedure (Interfaced AS only) DAY-CYCL-OPEN = Open Daylight Cycle (Interfaced AS only) DAY-CYCL-CLOS = Close Daylight Cycle (Interfaced AS only) DAY-PROC-CLOS = Close Daylight Procedure (Interfaced AS only) NB : When the night-time procedure is closed, a daylight procedure can be open during the night-time trade phase
		Optional	Validation: [0..1]
<SbjtDtls>-</SbjtDtls>	11x	BIC	If the sender is a CB on behalf of the AS, this field is filled with the BIC of the AS
		Optional	Validation: [0..1]
</GnlBizInf>		End of GeneralBusinessInformation	End of GeneralBusinessInformation
		Mandatory	Validation: [1..1]
</GnlBizRpt>		End of GeneralBusinessReport	End of GeneralBusinessReport
		Mandatory	Validation: [1..n]
</BizRpt>		End of BusinessReport	End of BusinessReport
		Mandatory	Validation: [1..1]
</RtrGnlBizInf>		End of Message Type	End of Message Type of ReturnGeneralBusinessInformation
		Mandatory	Validation: [1..1]

Error Codes:

ReturnGeneralBusinessInformation_ASI_1

Scope: ReturnGeneralBusinessInformation message can be sent by the ASI (sender of the message = BIC of the ASI)

*to the AS via ASI for:

-Notification of Start of overnight procedure triggered by the ASI at the start of day

Message Type	<RtrGnlBizInf>
Message Identification	<MsgId>
Message business identification	<Id>ABC1234</Id>
End Message Identification	</MsgId>
BusinessReport	<BizRpt>
GeneralBusinessReport	<GnlBizRpt>
BusinessInformationReference	<BizInfRef>ABC1234</BizInfRef>
GeneralBusinessInformation	<GnlBizInf>
Qualifier	<Qlfr>
Isformatted	<IsFrmtd>>true</IsFrmtd>
End of Qualifier	</Qlfr>
Subject	<Sbjt>OVN-PROC-OPN</Sbjt>
End of GeneralBusinessInformation	</GnlBizInf>
End of GeneralBusinessReport	</GnlBizRpt>
End of BusinessReport	</BizRpt>
End of Message Type	</RtrGnlBizInf>

ReturnGeneralBusinessInformation_ASI_1b

Scope: ReturnGeneralBusinessInformation message can be sent by the ASI (sender of the message = BIC of the ASI)
*to the AS via ASI for:
-Notification of release of liquidity (LIQ-CYCL-END) after End of Cycle ordered by the AS via ASI or via an ICM screen (night-time and daylight)

Message Type	<RtrGnlBizInf>
Message Identification	<MsgId>
Message business identification	<Id>ABC1234</Id>
End Message Identification	</MsgId>
BusinessReport	<BizRpt>
GeneralBusinessReport	<GnlBizRpt>
BusinessInformationReference	<BizInfRef>ABC1234</BizInfRef>
GeneralBusinessInformation	<GnlBizInf>
Qualifier	<Qlfr>
Isformatted	<IsFrmtd>>true</IsFrmtd>
End of Qualifier	</Qlfr>
Subject	<Sbjt>LIQ-CYCL-END</Sbjt>
End of GeneralBusinessInformation	</GnlBizInf>
End of GeneralBusinessReport	</GnlBizRpt>
End of BusinessReport	</BizRpt>
End of Message Type	</RtrGnlBizInf>

6. 6. 9 SBTransferInitiation

SSP Proprietary Messages

SBTransferInitiation_AS

Scope: The SBTransferInitiation message is sent by a Settlement Bank to the ASI, via ICM, to debit ist RTGS account in order to increase the liquidity on the Technical account - procedure 6 real-time of a real-time AS.
The FirstAgent is debited in the PM against the credit of the FinalAgent.
Option : The AS participants which are credited or debited in the SSS may be indicated in the elements "Creditor" and "Debtor". They will be filled in the ATransferNotice sent to the SSS.
The "Debtor" BIC will be mapped to field 72 of the MT900.
The contents of field "Ustrd" will be mapped to field 72 of the MT900.

<pain.998.001.xx>

Structure:

Message Type	<pain.998.001.01>
Message Identification	<MsgId>
Message Reference	<Ref>/Ref>
End Message Identification	</MsgId>
Proprietary Data	<PrtryDt>
Proprietary Data type	<Tp>SBTransferInitiation</Tp>
SSP Proprietary Data	<SspPrtryDt>
PaymentInformation	<PmtInf>
Debtor	<Dbtr>
Financial institution	<FI>
BIC	<BIC>/BIC>
End of financial institution	</FI>
End of debtor	</Dbtr>
First Agent	<FrstAgt>
BIC	<BIC>/BIC>
End First Agent	</FrstAgt>
Information payment transaction.	<PmtTx>
PaymentIdentification	<PmtId>
EndToEndIdentification	<EndToEndId>/EndToEndId>
EndPaymentIdentification	</PmtId>
Amount	<Amt>
InstructedAmount	<InstAmt>/InstAmt>
End of Amount	</Amt>
Creditor	<Cdtr>
Financial institution	<FI>
BIC	<BIC>/BIC>
End of financial institution	</FI>
End of Creditor	</Cdtr>
CreditorAccount	<CdtrAcct>
Simple Identification Information	<DmstAcct>
Identification	<Id>/Id>
End of simple Identification Information	</DmstAcct>
EndCreditorAccount	</CdtrAcct>
Final Agent	<FnIAgt>
BIC	<BIC>/BIC>
End of Final Agent	</FnIAgt>
RemittanceInformation	<RmtInf>
Unstructured	<Ustrd>/Ustrd>
EndRemittanceInformation	</RmtInf>
End of Information payment transaction.	</PmtTx>

EndPaymentInformation				</PmtInf>
End of SSP Proprietary Data				</SspPrtryDt>
End of Proprietary Data				</PrtryDt>
End Message Type				</pain.998.001.01>

Attributes:

name of attribute	format	short description	description
<pain.998.001.01>		Message Type	SSP proprietary message for Ancillary system interface
		Mandatory	Validation: [1..1]
<MsgId>		Message Identification	
		Mandatory	Validation: [1..1]
<Ref>-</Ref>	16x	Message Reference	Unique and unambiguous reference
			String of characters that uniquely identifies a message at senders side
		Mandatory	Validation: [1..1] The length is limited to 16x maximum The contents must comply with the FIN set of characters and must not contain slashes.
</MsgId>		End Message Identification	End of Message Identification
		Mandatory	Validation: [1..1]
<PrtryDt>		Proprietary Data	Proprietary Data
			Container which defines the free format message
		Mandatory	Validation: [1..1]
<Tp>-</Tp>		Proprietary Data type	
		Mandatory	Validation: [1..1]always "SBTransferInitiation"
<SspPrtryDt>		SSP Proprietary Data	SSP Proprietary Data
		Mandatory	Validation: [1..1]
<PmtInf>		PaymentInformation	Set of characteristics that applies to the debit side of the payment transactions
		Mandatory	Validation: [1..1]
<Dbtr>		Debtor	Information about the debtor of a payment.
		Optional	Validation: [0..1]
<FI>		Financial institution	Financial institution
		Mandatory	Validation: [1..1]
<BIC>-</BIC>	11x	BIC	=BIC of the ordering institution
		Mandatory	Validation: [1..1] Not checked
</FI>		End of financial institution	End of financial institution

name of attribute	format	short description	description
		Mandatory	Validation: [1..1]
</Dbtr>		End of debtor	
		Optional	Validation: [0..1]
<FrstAgt>		First Agent	
		Mandatory	Validation: [1..1]
<BIC>-</BIC>	11x	BIC	=BIC debited in the SSP
		Mandatory	Validation: [1..1] Checked in the framework of Addressing rules
</FrstAgt>		End First Agent	End First Agent
		Mandatory	Validation: [1..1]
<PmtTx>		Information payment transaction.	Payment processes required to transfer cash from the debtor to the creditor.
		Mandatory	Validation: [1..1] Only one occurrence of PaymentTransaction in PaymentInformation
<PmtId>		PaymentIdentification	Set of elements to provide further means of referencing a payment transaction
		Mandatory	Validation: [1..1]
<EndToEndId>-</EndToEndId>	16x	EndToEndIdentification	Unique and unambiguous identification of a payment transaction, as assigned by any of the parties on the initiating side, that will be passed on throughout the entire end-to-end chain
		Mandatory	Validation: [1..1]
</PmtId>		EndPaymentIdentification	End of Set of elements to reference a payment transaction
		Mandatory	Validation: [1..1]
<Amt>		Amount	
		Mandatory	Validation: [1..1] The amount must be compatible with the format 15d used in FIN messages The amount must be different from zero
<InstAmt>-</InstAmt>	15d	InstructedAmount	Amount of money to be transferred between debtor and creditor expressed in Euros
		Mandatory	Validation: [1..1] Total digits = 15 Fraction digits = 2
</Amt>		End of Amount	
		Mandatory	Validation: [1..1]

name of attribute	format	short description	description
<Cdtr>		Creditor	Provides details about a system and about a member of a system.
		Optional	Validation: [0..1]
<FI>		Financial institution	Financial institution
		Mandatory	Validation: [1..1]
<BIC>-</BIC>	11x	BIC	=BIC of the final beneficiary (after the FinalAgent) If it is filled, it will be copied in ASTransferNotice
		Mandatory	Validation: [1..1] Not checked
</FI>		End of financial institution	End of financial institution
		Mandatory	Validation: [1..1]
</Cdtr>		End of Creditor	
		Optional	Validation: [0..1]
<CdtrAcct>		CreditorAccount	
		Optional	Validation: [0..1]
<DmstAcct>		Simple Identification Information	Simple Identification Information Account of the final beneficiary
		Mandatory	Validation: [1..1]
<Id>-</Id>	35x	Identification	Identification of an entity If it is filled, it will be copied in ASTransferNotice
		Mandatory	Validation: [1..1] The contents must comply with the FIN set of characters.
</DmstAcct>		End of simple Identification Information	
		Mandatory	Validation: [1..1]
</CdtrAcct>		EndCreditorAccount	
		Optional	Validation: [0..1]
<FnIAgt>		Final Agent	Provides details about a system and about a member of a system Is the BIC of the Technical account - procedure 6 real-time to be credited in the SSP
		Mandatory	Validation: [1..1]
<BIC>-</BIC>	11x	BIC	
		Mandatory	Validation: [1..1] Checked in the framework of addressing validation rules

name of attribute	format	short description	description
</FnIAgt>		End of Final Agent	End of Final Agent
		Mandatory	Validation: [1..1]
<RmtInf>		RemittanceInformation	
		Optional	Validation: [0..1]
<Ustrd>-</Ustrd>	140x	Unstructured	Shall be mapped to the remittance information of the payment transaction branch of the ATransferNotice sent to the AS Shall be mapped to the MT900 field 72
		Mandatory	Validation: [1..1] The contents must comply with the FIN set of characters.
</RmtInf>		EndRemittanceInformation	
		Optional	Validation: [0..1]
</PmtTx>		End of Information payment transaction.	
		Mandatory	Validation: [1..1]
</PmtInf>		EndPaymentInformation	
		Mandatory	Validation: [1..1]
</SspPrtryDt>		End of SSP Proprietary Data	End of SSP Proprietary Data
		Mandatory	Validation: [1..1]
</PrtryDt>		End of Proprietary Data	End of Proprietary Data
		Mandatory	Validation: [1..1]
</pain.998.001.01>		End Message Type	
		Mandatory	Validation: [1..1]

Error Codes:

Order	Error code				Error Text / Validation/ Remark
	SSP	Y-copy	V-shape	XML	
1	X00			0000	Error Text: O.k. Validation: Confirmation that a task is stored in the task queue. A related reference for the subsequent processing (e.g. confirmation) of the task is returned Remark:
2	P42			P212	Error Text: Reference limited to 16 alphanumeric characters Validation: The length of the message identification must be limited to 16x maximum Remark:
3	P44			P214	Error Text: FirstAgent not allowed Validation: The FirstAgent must belong to the DN of the sender Remark:
4	P46			P216	Error Text: FinalAgent not allowed Validation: The FinalAgent must be the BIC of the Technical account - procedure 6 real-time which is authorized for the SB indicated as FirstAgent Remark:
5	P60			P060	Error Text: Only valid BICs are allowed. Validation: Field 52 must be a valid BIC according BIC directory. Remark:
6	P60			P060	Error Text: Only valid BICs are allowed. Validation: Field 58 (BIC) must be a valid BIC according BIC directory. Remark:
7	A56			A056	Error Text: Related AS does not participate in settlement procedure 6 real-time Validation: Related AS does participate in settlement model 6 real-time Remark:
8	A57			A057	Error Text: Final Agent must be a Technical account - procedure 6 real-time Validation: Final Agent is a Technical account - procedure 6 real-time Remark:
9	A58			A058	Error Text: Settlement bank is not allowed to address this Technical account - procedure 6 real-time Validation: Settlement bank is allowed to address this Technical account - procedure 6 real-time Remark:
10	X41			1401	Error Text: No permission. RBAC User role(s) are not sufficient. Validation: RBAC role name "APPLICATE", "APPLICBTE", "APPLICSTE" or "APPLIASTE" are required. Remark: checked by ICM / ReturnTransaction

SBTransferInitiation_AS_1

Scope: This message is sent by a Settlement Bank to the ASI, via ICM, to debit its RTGS account in order to increase the liquidity on the Technical account - procedure 6 real-time of a real-time AS.

Message Type	<pain.998.001.01>
Message Identification	<MsgId>
Message Reference	<Ref>SBTBS1HM181218F</Ref>
End Message Identification	</MsgId>
Proprietary Data	<PrtryDt>
Proprietary Data type	<Tp>SBTransferInitiation</Tp>
SSP Proprietary Data	<SspPrtryDt>
PaymentInformation	<PmtInf>
Debtor	<Dbtr>
Financial institution	<FI>
BIC	<BIC>BACRIT22</BIC>
End of financial institution	</FI>
End of debtor	</Dbtr>
First Agent	<FrstAgt>
BIC	<BIC>ZYAJFRT0BS1</BIC>
End First Agent	</FrstAgt>
Information payment transaction.	<PmtTx>
PaymentIdentification	<PmtId>
EndToEndIdentification	<EndToEndId>BACRIT0987</EndToEndId>
EndPaymentIdentification	</PmtId>
Amount	<Amt>
InstructedAmount	<InstAmt>55</InstAmt>
End of Amount	</Amt>
Creditor	<Cdtr>
Financial institution	<FI>
BIC	<BIC>BITAITR02P2</BIC>
End of financial institution	</FI>
End of Creditor	</Cdtr>
CreditorAccount	<CdtrAcct>
Simple Identification Information	<DmstAcct>
Identification	<Id>CPT9876543210</Id>
End of simple Identification Information	</DmstAcct>
EndCreditorAccount	</CdtrAcct>
Final Agent	<FnIAgt>
BIC	<BIC>ZYAJFRT0HM1</BIC>
End of Final Agent	</FnIAgt>
RemittanceInformation	<RmtInf>
Unstructured	<Ustrd>SBTransferInitiation2</Ustrd>
EndRemittanceInformation	</RmtInf>
End of Information payment transaction.	</PmtTx>
EndPaymentInformation	</PmtInf>
End of SSP Proprietary Data	</SspPrtryDt>
End of Proprietary Data	</PrtryDt>
End Message Type	</pain.998.001.01>

6. 7 XML messages related to HAM

6. 7. 1 CancelTransaction (for CBs only)

Cash Management Standard

CancelTransaction_HAM

Scope: The Cancel Transaction Message is used by NCBs to cancel a transaction (queued or delivered in advance) on behalf of the account holder. This message will be replied by a Receipt Message. Non-Repudiation of Emission (NRE) is supported.

<camt.008.001.xx>

Structure:

MessageName for CancelTransaction	<CclTx>
Message Header	<MsgHdr>
Message Identification	<MsgId></MsgId>
End of Message Header	</MsgHdr>
PaymentIdentification	<PmtId>
Choice	xorShrtBizIdPrtryRef
Short Business Identification	<ShrtBizId>
TransactionIdentification	<TxId></TxId>
Value date	<IntrBkSttlmDt></IntrBkSttlmDt>
Instructing Agent	<InstgAgt>
Financial Institution Identification	<FinInstnId>
BICFIIdentifier	<BICFI></BICFI>
End of Financial Institution Identification	</FinInstnId>
End of Instructing Agent	</InstgAgt>
End ShortBusinessIdentification	</ShrtBizId>
ProprietaryId	<PrtryId></PrtryId>
End of choice	/xorShrtBizIdPrtryRef
EndPaymentIdentification	</PmtId>
End of MessageName for CancelTransaction	</CclTx>

Attributes:

name of attribute	format	short description	description
<CcITx>		Message name for CancelTransaction Mandatory	Validation: [1..1]
<MsgHdr>		Message Header Mandatory	Set of characteristics specific to the message Validation: [1..1]
<MsgId>-</MsgId>	35x	Message Identification Mandatory	Message Identification String of characters that uniquely identifies a message at senders side. Validation: [1..1]
</MsgHdr>		End of Message Header Mandatory	Validation: [1..1]
<PmtId>		PaymentIdentification Mandatory	Set of elements to provide further means of referencing a payment transaction Validation: [1..1]
xorShrtBizIdPrtryRef		Choice Mandatory	Choice amongst ShrtBizId or PrtryRef. Validation: [1..1]
<ShrtBizId>		Short Business Identification Mandatory	Validation: [1..1]
<TxId>-</TxId>	35x	TransactionIdentification Mandatory	Unique and unambiguous identification of a payment transaction, as assigned by the originator. The payment transaction reference is used for reconciliation or to link tasks relating to the payment transaction. TRN of the original payment instruction. If present, all <PmtInstrRef>, <IntrBkValDt> and <InstgAgtd> must be present (HAM business identifier). If present, <PrtryRef> (Internal transfer identifier) is not allowed. Validation: [1..1]
<IntrBkSttlmDt>-</IntrBkSttlmDt>	ISODate	Value date Mandatory	Value date Settlement date (yyyy-mm-dd) If present, all <PmtInstrRef>, <IntrBkValDt> and <InstgAgtd> must be present (HAM business identifier). If present, <PrtryRef> (Internal transfer identifier) is not allowed . Validation: [1..1]
<InstgAgt>		Instructing Agent Mandatory	Instructing Agent Validation: [1..1]
<FinInstnId>		Financial Institution Identification Mandatory	Financial Institution Identification Validation: [1..1]

name of attribute	format	short description	description
<BICFI>-</BICFI>	4!a2!a2!c3!c	BICFIIdentifier	BICFIIdentifier BIC of the instructing agent (sender of the transaction instruction). If present, all <PmtInstrRef>, <IntrBkValDt> and <InstgAgtId> must be present (HAM business identifier). If present, <PrtryRef> (Internal transfer identifier) is not allowed. Mandatory Validation: [1..1]
</FinInstnId>		End of Financial Institution Identification Mandatory	End of Financial Institution Identification Validation: [1..1]
</InstgAgt>		End of Instructing Agent Mandatory	End of Instructing Agent Validation: [1..1]
</ShrtBizId>		End ShortBusinessIdentification Mandatory	Validation: [1..1]
<PrtryId>-</PrtryId>	43x	ProprietaryId Mandatory	ProprietaryId Internal transfer identifier. Unique and unambiguous identifier of a transaction, generated by HAM. If present, <PmtInstrRef>, <IntrBkValDt> and <InstgAgtId> (HAM business identifier) are not allowed. Validation: [1..1]
/xorShrtBizIdPrtryRef		End of choice Mandatory	Validation: [1..1]
</PmtId>		EndPaymentIdentification Mandatory	End of Set of elements to reference a payment transaction Validation: [1..1]
</CclTx>		End of Messagename for CancelTransaction Mandatory	Validation: [1..1]

Error Codes:

Order	Error code				Error Text / Validation/ Remark
	SSP	Y-copy	V-shape	XML	
1	X41			1401	Error Text: No permission. RBAC User role(s) are not sufficient. Validation: RBAC role name "APPLICBTE" is required Remark: checked by ICM / Receipt
2	X44			1404	Error Text: If "non repudiation of emission" is mandatory, the NRE indicator flag has to be present Validation: If non-repudiaton processing is mandatory, the tag <SwInt:NRIndicator>TRUE</SwInt:NRIndicator> has to be present. Remark: Receipt /checked by ICM
3	868	C8	XI19	2868	Error Text: Invalid sending/receiving BIC Validation: Remark:
4	866	C6	AC06	2866	Error Text: Exclusion of participant Validation: Remark:
5	861	C1	RF01	2861	Error Text: Double input Validation: Remark:
6	852	B2	XI12	2852	Error Text: Invalid character or invalid numeric value Validation: Remark:
7	H10	M1		H010	Error Text: Data not found (request data does not exist) Validation: Remark:
8	H08			H008	Error Text: Requestor unknown Validation: Remark:
9	H01		XI01	H001	Error Text: Sender not allowed Validation: Remark:

CancelTransaction_HAM_1

Scope: Request to cancel a transaction identified through an Internal Transfer Identifier.

MessageName for CancelTransaction	<CclTx>
Message Header	<MsgHdr>
Message Identification	<MsgId>HACDEFGHIL1234567890ABCDEFGHIIL12345</MsgId>
End of Message Header	</MsgHdr>
PaymentIdentification	<PmtId>
ProprietaryId	<PrtryId>ABCDEFGHIIL1234567890ABCDEFGHIIL1234567890ABC</PrtryId>
EndPaymentIdentification	</PmtId>
End of MessageName for CancelTransaction	</CclTx>

CancelTransaction_HAM_2

Scope: Request to cancel a transaction identified through an external transfer identifier (HAM Business identifier).

Messagename for CancelTransaction	<CclTx>
Message Header	<MsgHdr>
Message Identification	<MsgId>HACDEFGHIJKLMNOPQRST123456789012345</MsgId>
End of Message Header	</MsgHdr>
PaymentIdentification	<PmtId>
Short Business Identification	<ShrtBizId>
TransactionIdentification	<TxId>ABCDEFGHIL123456</TxId>
Value date	<IntrBkSttlmDt>2008-09-12</IntrBkSttlmDt>
Instructing Agent	<InstgAgt>
Financial Institution Identification	<FinInstnId>
BICFIIdentifier	<BICFI>BBBBITRRXX</BICFI>
End of Financial Institution Identification	</FinInstnId>
End of Instructing Agent	</InstgAgt>
End ShortBusinessIdentification	</ShrtBizId>
EndPaymentIdentification	</PmtId>
End of Messagename for CancelTransaction	</CclTx>

6. 7. 2 GetAccount

Cash Management Standard

GetAccount_HAM

Scope: The Get Account Message is used by account holders in HAM (or by Co-managers and NCBs on behalf of the account holder) to request information about the balance of the account. The message is also used by account holders (or by NCBs on behalf of the account holder) to request information about the value of the standing order for automatic liquidity transfers from HAM to RTGS account. This message will be replied by a Return Account Message.

<camt.003.001.xx>

Structure:

Message Type	<GetAcct>
Message Header	<MsgHdr>
Message Identification	<MsgId></MsgId>
End of Message Header	</MsgHdr>
Specification of the query criteria.	<AcctQryDef>
Account Criteria	<AcctCrit>
NewCriteria	<NewCrit>
SearchCriteria	<SchCrit>
Account Identification	<AcctId>
Country code	<CTTtxt></CTTtxt>
End of Account Identification	</AcctId>
CashAccountType	<Tp>
ExternalCashAccountTypeCode	<Cd></Cd>
End of CashAccountType	</Tp>
Account Owner	<AcctOwnr>
Identification	<Id>
OrganisationIdentification	<OrgId>
AnyBICIdentifier	<AnyBIC></AnyBIC>
End of OrganisationIdentification	</OrgId>
End Identification	</Id>
End of Account owner	</AcctOwnr>
End of SearchCriteria	</SchCrit>
Return Criteria	<RtrCrit>
Standing Order Indicator	<StgOrdrInd></StgOrdrInd>
End of ReturnCriteria	</RtrCrit>
End of NewCriteria	</NewCrit>
End Account Criteria	</AcctCrit>
End Account Query Definition	</AcctQryDef>
End Message Type	</GetAcct>

Attributes:

name of attribute	format	short description	description
<GetAcct>		Message Type Mandatory	Message name for GetAccount Validation: [1..1]
<MsgHdr>		Message Header Mandatory	Set of characteristics specific to the message Validation: [1..1]
<MsgId>-</MsgId>	35x	Message Identification Mandatory	Message Identification String of characters that uniquely identifies a message at senders side. Validation: [1..1]
</MsgHdr>		End of Message Header Optional	Validation: [1..1]
<AcctQryDef>		Specification of the query criteria. Mandatory	Validation: [0..1]
<AcctCrit>		Account Criteria Mandatory	Validation: [0..1]
<NewCrit>		NewCriteria Mandatory	Validation: [1..1]
<SchCrit>		SearchCriteria Mandatory	Validation: [0..1]
<AcctId>		Account Identification Optional	Account Identification This sequence is used when requesting information about CB customers, in order to univocally identify the CB customer account (through the country code of the relevant Central Bank). It is mandatory when the requested CB customer holds accounts at different Central Banks with the same BIC. Validation: [0..1]
<CTTt>-</ CTTt>	2x	Country code Mandatory	Specifies the country code of the Central Bank relevant for the requested CB customer account. Validation: [1..1]
</AcctId>		End of Account Identification Optional	Validation: [0..1]
<Tp>		CashAccountType Optional	CashAccountType Validation: [0..1]

name of attribute	format	short description	description
<Cd>-</Cd>		ExternalCashAccountType Code	ExternalCashAccountTypeCode SSP restricted code list: CACC = Current Account used to post debits and credits when no specific account has been nominated SACC = Settlement Account used to post debit and credit entries, as a result of transactions cleared and settled through a specific clearing and settlement system. It must be: "CACC" (current account). The attribute is mandatory in HAM (differently from Cash Management standard). Mandatory Validation: [0..1]
</Tp>		End of CashAccountType	End of CashAccountType Optional Validation:
<AcctOwnc>		Account Owner	Optional Validation: [0..1]
<Id>		Identification	Identification Unique and unambiguous identification for the account between the account owner and the account servicer. Optional Validation: [0..1]
<OrgId>		OrganisationIdentification	OrganisationIdentification Mandatory Validation: [1..1]
<AnyBIC>-</AnyBIC>	4!a2!a2!c[3!cAnyBICIdentifier]		AnyBICIdentifier / BIC used on behalf of third parties Specifies the participant to which the data are referred. The attribute is mandatory when the requestor is the co-manager of the participant or the NCB. Optional Validation: [0..1]
</OrgId>		End of OrganisationIdentification	End of OrganisationIdentification Mandatory Validation: [1..1]
</Id>		End Identification	End of EntityIdentifier Optional Validation: [0..1]
</AcctOwnc>		End of Account owner	Optional Validation: [0..1]
</SchCrit>		End of SearchCriteria	Mandatory Validation: [0..1]
<RtrCrit>		Return Criteria	Optional Validation:

name of attribute	format	short description	description
			[0..1]
<StgOrdrInd>-</StgOrdrInd>	1n	Standing Order Indicator	It must be present only when requesting information about the Standing Order for liquidity transfers from HAM to RTGS account. If present, it must be valorised as "1".
		Optional	Validation: [0..1]
</RtrCrit>		End of ReturnCriteria	
		Optional	Validation: [0..1]
</NewCrit>		End of NewCriteria	
		Mandatory	Validation: [1..1]
</AcctCrit>		End Account Criteria	
		Mandatory	Validation: [0..1]
</AcctQryDef>		End Account Query Definition	
		Mandatory	Validation: [0..1]
</GetAcct>		End Message Type	
		Mandatory	Validation: [1..1]

Error Codes:

Order	Error code				Error Text / Validation/ Remark
	SSP	Y-copy	V-shape	XML	
1	X41			1401	Error Text: No permission. RBAC User role(s) are not sufficient. Validation: RBAC role name "APPLICATE", "APPLICSTE" or "APPLICBTE" are required Remark: checked by ICM / ReturnAccount
2	H13			H013	Error Text: Requested field missing in input Validation: Remark:
3	866	C6	AC06	2866	Error Text: Exclusion of participant Validation: Remark:
4	852	B2	XI12	2852	Error Text: Invalid character or invalid numeric value Validation: Remark:
5	H14			H014	Error Text: Requested country code missing in input Validation: Remark:
6	H12			H012	Error Text: Requested BIC missing in input Validation: Remark:
7	H11			H011	Error Text: Requested BIC unknown Validation: Remark:
8	H08			H008	Error Text: Requestor unknown Validation: Remark:
9	H07	M7		H007	Error Text: Account not open Validation: Remark:
10	H01		XI01	H001	Error Text: Sender not allowed Validation: Remark:

GetAccount_HAM_1

Scope: Request of information about account balance. Requestor is the account owner.

Message Type	<GetAcct>
Message Header	<MsgHdr>
Message Identification	<MsgId>HACDEFGHIJKLMNOPQRST123456789012345</MsgId>
End of Message Header	</MsgHdr>
Specification of the query criteria.	<AcctQryDef>
Account Criteria	<AcctCrit>
NewCriteria	<NewCrit>
SearchCriteria	<SchCrit>
CashAccountType	<Tp>
ExternalCashAccountTypeCode	<Cd>CACC</Cd>
End of CashAccountType	</Tp>
End of SearchCriteria	</SchCrit>
End of NewCriteria	</NewCrit>
End Account Criteria	</AcctCrit>
End Account Query Definition	</AcctQryDef>
End Message Type	</GetAcct>

GetAccount_HAM_2

Scope: Request of information about account balance. Requestor is the co-manager of the account owner.

Message Type	<GetAcct>
Message Header	<MsgHdr>
Message Identification	<MsgId>HACDEFGHIJKLMNOPQRST123456789012345</MsgId>
End of Message Header	</MsgHdr>
Specification of the query criteria.	<AcctQryDef>
Account Criteria	<AcctCrit>
NewCriteria	<NewCrit>
SearchCriteria	<SchCrit>
CashAccountType	<Tp>
ExternalCashAccountTypeCode	<Cd>CACC</Cd>
End of CashAccountType	</Tp>
Account Owner	<AcctOwnr>
Identification	<Id>
OrganisationIdentification	<OrgId>
AnyBICIdentifier	<AnyBIC>BBBBITRRXX</AnyBIC>
End of OrganisationIdentification	</OrgId>
End Identification	</Id>
End of Account owner	</AcctOwnr>
End of SearchCriteria	</SchCrit>
End of NewCriteria	</NewCrit>
End Account Criteria	</AcctCrit>
End Account Query Definition	</AcctQryDef>
End Message Type	</GetAcct>

GetAccount_HAM_3

Scope: Request of information about the value of the standing order for liquidity transfers from HAM to RTGS account.
Requestor is the account owner.

Message Type	<GetAcct>
Message Header	<MsgHdr>
Message Identification	<MsgId>ABCDEFGHIJKLMNQRST123456789012345</MsgId>
End of Message Header	</MsgHdr>
Specification of the query criteria.	<AcctQryDef>
Account Criteria	<AcctCrit>
NewCriteria	<NewCrit>
SearchCriteria	<SchCrit>
CashAccountType	<Tp>
ExternalCashAccountTypeCode	<Cd>CACC</Cd>
End of CashAccountType	</Tp>
End of SearchCriteria	</SchCrit>
Return Criteria	<RtrCrit>
Standing Order Indicator	<StgOrdInd>1</StgOrdInd>
End of ReturnCriteria	</RtrCrit>
End of NewCriteria	</NewCrit>
End Account Criteria	</AcctCrit>
End Account Query Definition	</AcctQryDef>
End Message Type	</GetAcct>

6. 7. 3 GetBusinessDayInformation

Cash Management Standard

GetBusinessDayInformation _HAM

Scope: The Get Business Day Information Message is used by account holders in HAM to request information about the status of the HAM system and the events planned during the HAM operational day. This message will be replied by a Return Business Day Information Message.

<camt.018.001.xx>

Structure:

Message Type	<GetBizDayInf>
Message Header	<MsgHdr>
Message Identification	<MsgId></MsgId>
End of Message Header	</MsgHdr>
Business Day Information Query Definition	<BizDayInfQryDef>
BusinessDayCriteria	<Crit>
NewCriteria	<NewCrit>
SearchCriteria	<SchCrit>
SystemIdentification	<SysId>
CB Responsible	<Ctry></Ctry>
End of SystemIdentification	</SysId>
End of SearchCriteria	</SchCrit>
End of NewCriteria	</NewCrit>
End of BusinessDayCriteria	</Crit>
End of Business Day Information Query Definition	</BizDayInfQryDef>
End of Messagename for GetBusinessDayInformation	</GetBizDayInf>

Attributes:

name of attribute	format	short description	description
<GetBizDayInf>		Message Type Mandatory	Validation: [1..1]
<MsgHdr>		Message Header Mandatory	Set of characteristics specific to the message Validation: [1..1]
<MsgId>-</MsgId>	35x	Message Identification Mandatory	Message Identification String of characters that uniquely identifies a message at senders side. Validation: [1..1]
</MsgHdr>		End of Message Header Mandatory	Validation: [1..1]
<BizDayInfQryDef>		Business Day Information Query Definition Optional	Validation: [0..1]
<Crit>		BusinessDayCriteria Optional	Validation: [0..1]
<NewCrit>		NewCriteria Mandatory	Defines the criteria based on which the information is extracted. Validation: [1..1]
<SchCrit>		SearchCriteria Optional	Validation: [0..1]
<SysId>		SystemIdentification Optional	Validation: [0..1]
<Ctry>-</Ctry>	2!c	CB Responsible Mandatory	Country Code of the Responsible CB. Country code of the Central Bank using HAM. The attribute must be used if the requestor is a CB customer holding more than one account at different Central Banks (with the same BIC11), in order to specify the relevant Central Bank. Validation: [1..1]
</SysId>		End of SystemIdentification Optional	End of SystemIdentificationChoice Validation: [0..1]
</SchCrit>		End of SearchCriteria Optional	Validation: [0..1]
</NewCrit>		End of NewCriteria	

name of attribute	format	short description	description
		Mandatory	Validation: [1..1]
</Crit>		End of BusinessDayCriteria Optional	Validation: [0..1]
</BizDayInfQryDef>		End of Business Day Information Query Definition Optional	Validation: [0..1]
</GetBizDayInf>		End of Messagename for GetBusinessDayInformation Mandatory	Validation: [1..1]

Error Codes:

Order	Error code				Error Text / Validation/ Remark
	SSP	Y-copy	V-shape	XML	
1	X41			1401	Error Text: No permission. RBAC User role(s) are not sufficient. Validation: RBAC role name "APPLICATE", "APPLICSTE" or "APPLICBTE" are required Remark: checked by ICM / ReturnBusinessDayInformation
2	866	C6	AC06	2866	Error Text: Exclusion of participant Validation: Remark:
3	H09			H009	Error Text: Parameter logical error <.> Validation: Remark:
4	H08			H008	Error Text: Requestor unknown Validation: Remark:
5	H06			H006	Error Text: No data available (e.g. an empty list) Validation: Remark:

GetBusinessDayInformation_HAM_1

Scope: Request of information performed by a HAM account holder about the status of the system and the events planned during the HAM operational day.

Message Type	<GetBizDayInf>
Message Header	<MsgHdr>
Message Identification	<MsgId>HACDEFGHIJKLMNOPQRST123456789012345</MsgId>
End of Message Header	</MsgHdr>
End of Messagename for GetBusinessDayInformation	</GetBizDayInf>

6.7.4 GetReservation

Cash Management Standard

GetReservation_HAM

Scope: The Get Reservation Message is used by HAM account holders (or by Co-managers and NCBs on behalf of the HAM account holder) to request information about the reservation for cash withdrawals (current or default). It is also used by CB customers (or by NCBs on behalf of CB Customers) to request information about the value of the threshold for advice of investment. This message will be replied by a Return Reservation Message.

<camt.046.001.xx>

Structure:

message name for GetReservation	<GetRsvatn>
Message Header	<MsgHdr>
Message Identification	<MsgId></MsgId>
End of Message Header	</MsgHdr>
ReservationQueryDefinition	<RsvatnQryDef>
ReservationCriteriaDefinition	<RsvatnCrit>
NewCriteria	<NewCrit>
SearchCriteria	<SchCrit>
SystemIdentification	<SysId>
Country Code	<Ctry></Ctry>
End of SystemIdentification	</SysId>
Choice	xorDfltRsvatnTpCurRsvatnTp
Default Reservation Type	<DfltRsvatnTp></DfltRsvatnTp>
Current Reservation Type	<CurRsvatnTp></CurRsvatnTp>
End of Choice	/xorDfltRsvatnTpCurRsvatnTp
Account Owner	<AcctOwnr>
Financial Institution Identification	<FinInstnId>
BICFIIdentifier	<BICFI></BICFI>
End of Financial Institution Identification	</FinInstnId>
End of Account owner	</AcctOwnr>
End of SearchCriteria	</SchCrit>
End of NewCriteria	</NewCrit>
End of ReservationCriteriaDefinition	</RsvatnCrit>
End of ReservationQueryDefinition	</RsvatnQryDef>
End of message name for GetReservation	</GetRsvatn>

Attributes:

name of attribute	format	short description	description
<GetRsvatn>		message name for GetReservation Mandatory	message name for GetReservation Validation: [1..1]
<MsgHdr>		Message Header Mandatory	Set of characteristics specific to the message Validation: [1..1]
<MsgId>-</MsgId>	35x	Message Identification Mandatory	Message Identification String of characters that uniquely identifies a message at senders side. Validation: [1..1]
</MsgHdr>		End of Message Header Mandatory	Validation: [1..1]
<RsvatnQryDef>		ReservationQueryDefinition Mandatory	ReservationQueryDefinition Validation: [1..1]
<RsvatnCrit>		ReservationCriteriaDefinitio n Mandatory	ReservationCriteriaDefinition Validation: [1..1]
<NewCrit>		NewCriteria Mandatory	Validation: [1..1]
<SchCrit>		SearchCriteria Mandatory	Validation: [1..1]
<SysId>		SystemIdentification Optional	This sequence must be used when requesting information about a CB customer (threshold for advice of investment) , in order to univocally identify the CB customer account (through the country code of the relevant Central Bank). It is mandatory when the requested CB customer holds accounts at different Central Banks with the same BIC. Validation: [0..1]
<Ctry>-</Ctry>	2!a	Country Code Mandatory	Country Code Specifies the country code of the Central Bank relevant for the requested CB customer. Validation: [1..1]
</SysId>		End of SystemIdentification Optional	Validation: [0..1]
xorDfltRsvatnTpCurRsvatnTp		Choice Mandatory	Choice amongst DfltRsvatnTp or CurRsvatnTp Validation:

name of attribute	format	short description	description
			[1..1]
<DfltRsvatnTp>- </DfltRsvatnTp>	4x	Default Reservation Type	Specifies the type of default reservation. It can be "CARE" (Reservation for Cash Withdrawals) or – alternatively- "THRE " (Threshold for Advise of Investment). It is not possible to repeat this attribute more than once in the same message. The attributes "DfltRsvatnTp " and "CurRsvatnTp" are mutually exclusive. If "DfltRsvatnTp" is valorised , "CurRsvatnTp" must not be valorised, and viceversa. Mandatory Validation: [1..1]
<CurRsvatnTp>- </CurRsvatnTp>	4x	Current Reservation Type	Specifies the type of current reservation. The only possible value is: "CARE" (for Reservation for Cash Withdrawals). The attributes " DfltRsvatnTp " and "CurRsvatnTp" are mutually exclusive. If "CurRsvatnTp" is valorised , "DfltRsvatnTp" must not be valorised, and viceversa. When a current reservation is requested, the data provided are related to the current date and to all the future dates for which a current reservation exist. Mandatory Validation: [1..1]
/xorDfltRsvatnTpCurRsvatnTp		End of Choice Mandatory	Validation: [1..1]
<AcctOwnr>		Account Owner Optional	Validation: [0..1]
<FinInstnId>		Financial Institution Identification Mandatory	Financial Institution Identification Validation: [1..1]
<BICFI>-</BICFI>	4!a2!a2!c3!c	BICFIIdentifier Optional	BICFIIdentifier Specifies the participant to which the reservation is referred. The attribute is mandatory when the requestor is the co-manager of the participant or the NCB. Validation: [0..1]
</FinInstnId>		End of Financial Institution Identification Mandatory	End of Financial Institution Identification Validation: [1..1]
</AcctOwnr>		End of Account owner Optional	Validation: [0..1]
</SchCrit>		End of SearchCriteria Mandatory	Validation: [1..1]
</NewCrit>		End of NewCriteria Mandatory	Validation: [1..1]
</RsvatnCrit>		End of ReservationCriteriaDefinitio n	end of ReservationCriteriaDefinition

name of attribute	format	short description	description
		Mandatory	Validation: [1..1]
</RsvatnQryDef>		End of ReservationQueryDefinition Mandatory	end of ReservationQueryDefinition Validation: [1..1]
</GetRsvatn>		End of message name for GetReservation Mandatory	end of message name for GetReservation Validation: [1..1]

Error Codes:

Order	Error code				Error Text / Validation/ Remark
	SSP	Y-copy	V-shape	XML	
1	X41			1401	Error Text: No permission. RBAC User role(s) are not sufficient. Validation: RBAC role name "APPLICATE", "APPLICSTE" or "APPLICBTE" are required Remark: checked by ICM / ReturnReservation
2	868	C8	XI19	2868	Error Text: Invalid sending/receiving BIC Validation: Remark:
3	866	C6	AC06	2866	Error Text: Exclusion of participant Validation: Remark:
4	H14			H014	Error Text: Requested country code missing in input Validation: Remark:
5	H12			H012	Error Text: Requested BIC missing in input Validation: Remark:
6	H11			H011	Error Text: Requested BIC unknown Validation: Remark:
7	H08			H008	Error Text: Requestor unknown Validation: Remark:
8	H07	M7		H007	Error Text: Account not open Validation: Remark:
9	H01		XI01	H001	Error Text: Sender not allowed Validation: Remark:

GetReservation_HAM_1

Scope: Request of information about threshold for advice of investment. The requestor is the account owner.

message name for GetReservation	<GetRsvatn>
Message Header	<MsgHdr>
Message Identification	<MsgId>ABCDEFGHIJKLMNQRST123456789012345</MsgId>
End of Message Header	</MsgHdr>
ReservationQueryDefinition	<RsvatnQryDef>
ReservationCriteriaDefinition	<RsvatnCrit>
NewCriteria	<NewCrit>
SearchCriteria	<SchCrit>
Default Reservation Type	<DfltRsvatnTp>THRE</DfltRsvatnTp>
End of SearchCriteria	</SchCrit>
End of NewCriteria	</NewCrit>
End of ReservationCriteriaDefinition	</RsvatnCrit>
End of ReservationQueryDefinition	</RsvatnQryDef>
End of message name for GetReservation	</GetRsvatn>

GetReservation_HAM_2

Scope: Request of information about current reservation for cash withdrawals. The requestor is the NCB of the account owner.

message name for GetReservation	<GetRsvatn>
Message Header	<MsgHdr>
Message Identification	<MsgId>ABCDEFGHIJKLMNQRST123456789012345</MsgId>
End of Message Header	</MsgHdr>
ReservationQueryDefinition	<RsvatnQryDef>
ReservationCriteriaDefinition	<RsvatnCrit>
NewCriteria	<NewCrit>
SearchCriteria	<SchCrit>
Current Reservation Type	<CurRsvatnTp>CARE</CurRsvatnTp>
Account Owner	<AcctOwnr>
Financial Institution Identification	<FinInstnId>
BICFIIdentifier	<BICFI>BBBBITRRXXX</BICFI>
End of Financial Institution Identification	</FinInstnId>
End of Account owner	</AcctOwnr>
End of SearchCriteria	</SchCrit>
End of NewCriteria	</NewCrit>
End of ReservationCriteriaDefinition	</RsvatnCrit>
End of ReservationQueryDefinition	</RsvatnQryDef>
End of message name for GetReservation	</GetRsvatn>

6. 7. 5 GetThreshold (for CBs only)

SSP Proprietary Messages

GetThreshold_HAM

Scope: The Get Threshold Message is used by NCBs to request information about the threshold for advice of investment of “CB customers” and about the value of funds above the threshold. This message will be replied by a Return Threshold Message.

<camt.998.001.xx>

Structure:

Name Proprietary message	<PrtryMsg>
Message Header	<MsgHdr>
Message Identification	<MsgId></MsgId>
End of Message Header	</MsgHdr>
Proprietary Data	<PrtryData>
Type	<Tp>GetThreshold</Tp>
Proprietary Data	<Data>
SSP Proprietary Data	<SspPrtryDt>
Specification of the query criteria.	<AcctQryDef>
Account Criteria	<AcctCrit>
NewCriteria	<NewCrit>
SearchCriteria	<SchCrit>
Type	<Tp></Tp>
Balance	<Bal>
BalanceType	<BalTp></BalTp>
End Balance	</Bal>
End of SearchCriteria	</SchCrit>
End of NewCriteria	</NewCrit>
End Account Criteria	</AcctCrit>
End Account Query Definition	</AcctQryDef>
End of SSP Proprietary Data	</SspPrtryDt>
End of Proprietary Data	</Data>
End of Proprietary Data	</PrtryData>
End proprietary message	</PrtryMsg>

Attributes:

name of attribute	format	short description	description
<PrtryMsg>		Name Proprietary message Mandatory	Validation: [1..1]
<MsgHdr>		Message Header Mandatory	Set of characteristics specific to the message Validation: [1..1]
<MsgId>-</MsgId>	35x	Message Identification Mandatory	Message Identification String of characters that uniquely identifies a message at senders side. Validation: [1..1]
</MsgHdr>		End of Message Header Mandatory	Validation: [1..1]
<PrtryData>		Proprietary Data Mandatory	Proprietary Data Validation: [1..1]
<Tp>-</Tp>	35x	Type Mandatory	Identifies the type of message. It must be: "GetThreshold". Validation: [1..1]
<Data>		Proprietary Data Mandatory	Proprietary data content Validation: [1..1]
<SspPrtryDt>		SSP Proprietary Data Mandatory	SSP Proprietary Data Validation: [1..1]
<AcctQryDef>		Specification of the query criteria. Mandatory	Validation: [1..1]
<AcctCrit>		Account Criteria Mandatory	Validation: [1..1]
<NewCrit>		NewCriteria Mandatory	Validation: [1..1]
<SchCrit>		SearchCriteria Mandatory	Validation: [1..1]
<Tp>-</Tp>	35x	Type Mandatory	It must be: "CACC" (Current account). Validation: [1..1]

name of attribute	format	short description	description
<Bal>		Balance	This sequence must be repeted twice. The first time the tag <BalTp> (Balance type) must be valorised as "CRRT" (current balance) The second time the tag <BalTp> (Balance type) must be valorised as "THRE" (balance above the threshold).
		Mandatory	Validation: [2..2]
<BalTp>-</BalTp>	4x	BalanceType	Balance type code. In the first sequence of <Bal> (Balance), the tag <BalTp> (Balance type) must be valorised as "CRRT" (current balance). In the second sequence of <Bal> (Balance), the tag <BalTp> (Balance type) must be valorised as "THRE" (balance above the threshold).
		Mandatory	Validation: [1..1]
</Bal>		End Balance	
		Mandatory	Validation: [2..2]
</SchCrit>		End of SearchCriteria	
		Mandatory	Validation: [1..1]
</NewCrit>		End of NewCriteria	
		Mandatory	Validation: [1..1]
</AcctCrit>		End Account Criteria	
		Mandatory	Validation: [1..1]
</AcctQryDef>		End Account Query Definition	
		Mandatory	Validation: [1..1]
</SspPrtryDt>		End of SSP Proprietary Data	End of Root element for all SSP proprietary data
		Mandatory	Validation: [1..1]
</Data>		End of Proprietary Data	
		Mandatory	Validation: [1..1]
</PrtryData>		End of Proprietary Data	End of Proprietary Data
		Mandatory	Validation: [1..1]
</PrtryMsg>		End proprietary message	
		Mandatory	Validation: [1..1]

Error Codes:

Order	Error code				Error Text / Validation/ Remark
	SSP	Y-copy	V-shape	XML	
1	X41			1401	Error Text: No permission. RBAC User role(s) are not sufficient. Validation: RBAC role name "APPLICBTE" is required Remark: checked by ICM / ReturnThreshold
2	852	B2	XI12	2852	Error Text: Invalid character or invalid numeric value Validation: Remark:
3	H08			H008	Error Text: Requestor unknown Validation: Remark:
4	H06			H006	Error Text: No data available (e.g. an empty list) Validation: Remark:
5	H01		XI01	H001	Error Text: Sender not allowed Validation: Remark:

GetThreshold_HAM_1

Scope: Request of information about threshold for advice of investment and funds above the threshold

Name Proprietary message	<PrtryMsg>
Message Header	<MsgHdr>
Message Identification	<MsgId>HACDEFGHIJKLMNOPQRST123456789012345</MsgId>
End of Message Header	</MsgHdr>
Proprietary Data	<PrtryData>
Type	<Tp>GetThreshold</Tp>
Proprietary Data	<Data>
SSP Proprietary Data	<SspPrtryDt>
Specification of the query criteria.	<AcctQryDef>
Account Criteria	<AcctCrit>
NewCriteria	<NewCrit>
SearchCriteria	<SchCrit>
Type	<Tp>CACC</Tp>
Balance	<Bal>
BalanceType	<BalTp>CRRT</BalTp>
End Balance	</Bal>
Balance	<Bal>
BalanceType	<BalTp>THRE</BalTp>
End Balance	</Bal>
End of SearchCriteria	</SchCrit>
End of NewCriteria	</NewCrit>
End Account Criteria	</AcctCrit>
End Account Query Definition	</AcctQryDef>
End of SSP Proprietary Data	</SspPrtryDt>
End of Proprietary Data	</Data>
End of Proprietary Data	</PrtryData>
End proprietary message	</PrtryMsg>

6.7.6 GetTransaction

Cash Management Standard

GetTransaction _HAM

Scope: The Get Transaction Message is used by account holders in HAM (or by Co-managers and NCBs on behalf of the account holder) to request information about transactions.

The user can ask for:

- 1) a single transaction, identified via (i) the "HAM business identifier" (sender, TRN, settlement date) or, if known, (ii) the "internal transfer identifier";
- 2) one or more transactions selected by mean of search criteria; in this case it is mandatory to specify if debit or credit transactions are requested.

The user can also specify the following additional search criteria:

- a) transactions of a specific status; b) arrived in HAM within a time range; c) finalized in HAM within a time range; d) of a specific type; e) with a specific TRN; f) with a specific sender; g) with a specific counterpart; h) greater, lower or equal than a specific amount; i) to be settled in a specific date; l) triggered by a specific type of FIN message.

Finally, it is possible to ask for the FIN message that triggered a specific single transaction. In this case the user must specify an "internal transfer identifier" or a "HAM business identifier" and fill the tag <PmtTo><SysId> with the codeword "TGT".

Business Data Compression via delta sets is supported. GetTransaction message can be performed with the query type "CHNG", "MODF" or "DELD".

This message will be replied by a Return Transaction Message.

<camt.005.001.xx>

Structure:

Message name for GetTransaction	<GetTx>
Message Header	<MsgHdr>
Message Identification	<MsgId></MsgId>
End of Message Header	</MsgHdr>
Transaction Query Definition	<TxQryDef>
QueryTypeCode	<QryTp></QryTp>
Transaction Criteria	<TxCrit>
choice amongst	xorQryNmNewCrit
QueryName	<QryNm></QryNm>
NewCriteria	<NewCrit>
SearchCriteria	<SchCrit>
PaymentTo	<PmtTo>
SystemIdentification	<SysId>
ExternalCashClearingSystemCode	<Cd></Cd>
End of SystemIdentification	</SysId>
Member Identification	<Mmbld>
Financial Institution Identification	<FinInstnId>
BICFIIdentifier	<BICFI></BICFI>
End of Financial Institution Identification	</FinInstnId>
End Member Identification	</Mmbld>
Country Code	<Ctry></Ctry>
End PaymentTo	</PmtTo>
Payment From	<PmtFr>
SystemIdentification	<SysId>
ExternalCashClearingSystemCode	<Cd></Cd>
End of SystemIdentification	</SysId>
Member Identification	<Mmbld>
Financial Institution Identification	<FinInstnId>
BICFIIdentifier	<BICFI></BICFI>
End of Financial Institution Identification	</FinInstnId>
End Member Identification	</Mmbld>
Country Code	<Ctry></Ctry>
End Payment From	</PmtFr>

Payment Search	<PmtSch>
Choice	xorPmtIdGenericCriteria
PaymentIdentification	<PmtId>
Choice	xorShrtBizIdPrtryId
Short Business Identification	<ShrtBizId>
TransactionIdentification	<TxId></TxId>
Value date	<IntrBkSttlmDt></IntrBkSttlmDt>
Instructing Agent	<InstgAgt>
Financial Institution Identification	<FinInstnId>
BICFIIdentifier	<BICFI></BICFI>
End of Financial Institution Identification	</FinInstnId>
End of Instructing Agent	</InstgAgt>
End ShortBusinessIdentification	</ShrtBizId>
ProprietaryId	<PrtryId></PrtryId>
End of choice	/xorShrtBizIdPrtryId
EndPaymentIdentification	</PmtId>
RequestedExecutionDate	<ReqdExctnDt>
DateAndDateTimeSearch Choice	xorDtDtTmSch
Date Time Search	<DtTmSch>
choice	xorFrDtTmToDtTmDtTmRg
FromDateTime	<FrDtTm></FrDtTm>
ToDateTime	<ToDtTm></ToDtTm>
DateTimeRange	<DtTmRg>
From Date Time	<FrDtTm></FrDtTm>
To Date Time	<ToDtTm><ToDtTm>
End Date Time Range	</DtTmRg>
End of choice	/xorFrDtTmToDtTmDtTmRg
End Date Time Search	</DtTmSch>
Date Search	<DtSch>
DateSearchChoice	xorDtSch
From To Date	<FrToDt>
Date From	<FrDt></FrDt>
Date Till	<ToDt></ToDt>
End FromToDate	</FrToDt>
Equal Date	<EQDt></EQDt>
End Date Search	/xorDtSch
End of Date Search	</DtSch>
End of DateAndDateTimeSearch Choice	/xorDtDtTmSch
End of RequestedExecutionDate	</ReqdExctnDt>
PaymentStatus	<Sts>
PaymentStatusCode	<PmtInstrSts>
Choice	xorFnlStsPdgSts
Final Status	<FnlSts></FnlSts>
Pending Status	<PdgSts></PdgSts>
End of choice	/xorFnlStsPdgSts
End PaymentStatusCode	</PmtInstrSts>
Proprietary Status Reason	<PrtryStsRsn></PrtryStsRsn>
End of PaymentStatus	</Sts>
Instructed Amount	<InstdAmt>
Implied Currency and Amount Range	<ImpldCcyAndAmtRg>
Amount	<Amt>
Choice	xorFrAmtToAmt FrToAmtEQAmt

From amount					<FrAmt>
Boundary Amount					<BdryAmt></BdryAmt>
Inclusive flag					<Incl></Incl>
End from amount					</FrAmt>
To Amount					<ToAmt>
Boundary Amount					<BdryAmt></BdryAmt>
Inclusive flag					<Incl></Incl>
End To Amount					</ToAmt>
FromToAmount					<FrToAmt>
From amount					<FrAmt>
Boundary Amount					<BdryAmt></BdryAmt>
Inclusive flag					<Incl></Incl>
End from amount					</FrAmt>
To Amount					<ToAmt>
Boundary Amount					<BdryAmt></BdryAmt>
Inclusive flag					<Incl></Incl>
End To Amount					</ToAmt>
End From To Amount					</FrToAmt>
Equal Amount					<EQAmt></EQAmt>
End of choice					/xorFrAmtToAmt FrToAmtEQAmt
End of Amount					</Amt>
End ImpliedCurrencyandAmount Range					</ImpldCcyAndAmtRg>
End Instructed Amount					</InstdAmt>
Credit or debit indicator					<CdtDbtInd></CdtDbtInd>
PaymentMethod					<PmtMtd>
FIN Message Type					<FINMT><FINMT>
End Payment Method					</PmtMtd>
ProcessingValidityTime					<PrcgVldtyTm>
choice					xorFrDtTmToDtTmDtTmRg
From Date Time					<FrDtTm></FrDtTm>
To Date Time					<ToDtTm></ToDtTm>
DateTimeRange					<DtTmRg>
From Date Time					<FrDtTm></FrDtTm>
To Date Time					<ToDtTm></ToDtTm>
End Date Time Range					</DtTmRg>
End of choice					/xorFrDtTmToDtTmDtTmRg
End Processing Validity Time					</PrcgVldtyTm>
Payment Type					<PmtTp>
ProprietaryPaymentTypeCode					<Prtry></Prtry>
End Payment Type					</PmtTp>
TransactionIdentification					<Txld></Txld>
End of choice					/xorInstrRefGenericCriteria
End Payment Search					</PmtSch>
Account Entry Search					<AcctNtrySch>
Account Identification					<AcctId>
Country code					<CTTxt></CTTxt>
End of Account Identification					</AcctId>
Entry Date					<NtryDt>
DateAndDateTimeSearch Choice					xorDtDtTmSch
DateTimePeriodChoice					<DtTmSch>
choice					xorFrDtTmToDtTmDtTmRg
FromDateTime					<FrDtTm></FrDtTm>

ToDateTime	<ToDtTm></ToDtTm>
DateTimeRange	<DtTmRg>
FromDateTime	<FrDtTm></FrDtTm>
ToDateTime	<ToDtTm></ToDtTm>
End Date Time Range	</DtTmRg>
End of choice	/xorFrDtTmToDtTmDtTmRg
End of DateTimePeriodChoice	</DtTmSch>
Date Search	<DtSch>
Choice	xorFrToDtEQDt
From To Date	<FrToDt>
Start Date	<FrDt></FrDt>
End Date	<ToDt></ToDt>
End FromToDate	</FrToDt>
Equal Date	<EQDt></EQDt>
End of choice	/xorFrToDtEQDt
End Date Search	</DtSch>
End of DateAndDateTimeSearch Choice	/xorDtDtTmSch
End Entry Date	</NtryDt>
End AccountEntrySearch	</AcctNtrySch>
End of SearchCriteria	</SchCrit>
End of NewCriteria	</NewCrit>
End choice amongst	/xorQryNmNewCrit
End Transaction Criteria	</TxCrit>
End Transaction Query Definition	</TxQryDef>
End of Messagename for GetTransaction	</GetTx>

Attributes:

name of attribute	format	short description	description
<GetTx>		Message name for GetTransaction Mandatory	Message name for GetTransaction Validation: [1..1]
<MsgHdr>		Message Header Mandatory	Set of characteristics specific to the message Validation: [1..1]
<MsgId>-</MsgId>	35x	Message Identification Mandatory	Message Identification String of characters that uniquely identifies a message at senders side. Validation: [1..1]
</MsgHdr>		End of Message Header Mandatory	Validation: [1..1]
<TxQryDef>		Transaction Query Definition Mandatory	Validation: [0..1]
<QryTp>-</QryTp>		QueryTypeCode Optional	Specifies the nature of the query, i.e. whether the query requests that all matching items be returned or only new matching items since the last similar query be returned. ALLL = All Specifies that the query requests that all matching items be returned. CHNG = Changes Specifies that the query requests that only new matching items since the last similar query be returned. MODF = Modified Specifies that the query requests to return only items that have changed since the last query. DELD = Deleted Specifies that the query requests to return only items that were deleted since the last query. Further details can be found in the general chapter for delta set retrieval. Validation: [0..1]
<TxCrit>		Transaction Criteria Mandatory	Validation: [0..1]
xorQryNmNewCrit		choice amongst Mandatory	TransactionCriteriaDefinitionChoice QueryName and NewCriteria Defines the information that is searched either implicitly by recalling a previous query or explicitly by defining the criteria. QueryName [1..1] Max35Text TransactionCriteriaDefinitionChoice NewCriteria [1..1] TransactionCriteria Validation: [1..1]

name of attribute	format	short description	description
<QryNm>	35x	QueryName	Recalls the criteria (search and return criteria) defined in a preceding query. Identifier of a preceding message. The cross-reference is used for the creation of delta sets
		Mandatory	Validation: [1..1]
<NewCrit>		NewCriteria	
		Mandatory	Validation: [1..1]
<SchCrit>		SearchCriteria	
		Mandatory	Validation: [0..1]
<PmtTo>		PaymentTo	When credit transactions are selected (<CdtDbtInd> = CRDT), this sequence is used to specify the participant to whom transactions are referred (creditor). It can be used only once (repetition is not allowed) and is mandatory when the requestor is the co-manager of the participant or the NCB. When debit transactions are selected (<CdtDbtInd> = DBIT), this sequence is used to specify the counterpart(s) of the transactions and can be repeated up to 3 times.
		Optional	Validation: [0..3]
<SysId>		SystemIdentification	Identification of a particular cash clearing system.
		Optional	Validation: [0..1]
<Cd>-</Cd>	3x	ExternalCashClearingSystemCode	ExternalCashClearingSystemCode It must be used only in case of request of a FIN message that triggered a specific transaction. If used, it must be valorised with the codeword " TGT". It can be used only once (repetition is not allowed).
		Mandatory	Validation: [1..1]
</SysId>		End of SystemIdentification	End of SystemIdentificationChoice
		Optional	Validation: [0..1]
<MmblId>		Member Identification	
		Optional	Validation: [0..1]
<FinInstnId>		Financial Institution Identification	Financial Institution Identification
		Mandatory	Validation: [1..1]
<BICFI>-</BICFI>	4!a2!a2!c3!c	BICFIIdentifier	BICFIIdentifier
		Mandatory	Validation: [1..1]
</FinInstnId>		End of Financial Institution Identification	End of Financial Institution Identification
		Mandatory	Validation:

name of attribute	format	short description	description
			[1..1]
</Mmbld>		End Member Identification Optional	Validation: [0..1]
<Ctry>-</Ctry>	2!a	Country Code Optional	Country Code When debit transactions are requested (<CdtDbtInd> = DBIT) this attribute is used to select a specific counterpart country. If valorised, it must contain the country code of the counterpart country. Validation: [0..1]
</PmtTo>		End PaymentTo Optional	Validation: [0..3]
<PmtFr>		Payment From Optional	When debit transactions are requested (<CdtDbtInd> = DBIT) this sequence is used to identify the debtor (first occurrence of the sequence) and the sender of the transaction (second occurrence) . It can be used up to two times. In the first sequence, the attribute <BIC>-</BIC> must contain the BIC of the participant to whom transactions are referred (debtor). This occurrence is mandatory when the requestor is the co-manager of the participant or the NCB. In the second occurrence of the sequence (present only if the requestor which to select transactions sent by a specific participant) the attribute <BIC>-</BIC> must contain the BIC of the sender of the transactions. If the second BIC is present, also the first BIC must be present (even if it is equal to the requestor). When credit transactions are requested (<CdtDbtInd> = CRDT) this sequence is used to specify the counterpart(s) of the transactions and can be repeated up to 3 times. Validation: [0..3]
<SysId>		SystemIdentification Optional	Identification of a particular cash clearing system. Validation: [0..1]
<Cd>-</Cd>	3x	ExternalCashClearingSystemCode Mandatory	ExternalCashClearingSystemCode Validation: [1..1]
</SysId>		End of SystemIdentification Optional	End of SystemIdentificationChoice Validation: [0..1]
<Mmbld>		Member Identification Optional	Validation: [0..1]
<FinInstnId>		Financial Institution Identification Mandatory	Financial Institution Identification Validation: [1..1]
<BICFI>-</BICFI>	4!a2!a2!c3!c	BICFIIdentifier Mandatory	BICFIIdentifier Validation:

name of attribute	format	short description	description
			[1..1]
</FinInstnId>		End of Financial Institution Identification Mandatory	End of Financial Institution Identification Validation: [1..1]
</Mmbld>		End Member Identification Optional	Validation: [0..1]
<Ctry>-</Ctry>	2!a	Country Code Optional	Country Code When credit transactions are requested (<CdtDbtInd> = CRDT) this attribute is used to select a specific counterpart country. If valorised, it must contain the country code of the counterpart country. Validation: [0..1]
</PmtFr>		End Payment From Optional	Validation: [0..3]
<PmtSch>		Payment Search Optional	Validation: [0..1]
xorPmtIdGenericCriteria		Choice Mandatory	(generic search criteria: TrfValDt, InstrSts, InstdAmt, CdtDbtInd, PmtMtd, PrcgVldTm, PmtTp and PmtIntrRef). Validation: [1..1]
<PmtId>		PaymentIdentification Mandatory	Set of elements to provide further means of referencing a payment transaction This sequence is used when the requestor wants to select a single transaction, identified via a "HAM business identifier" (sender, TRN, settlement date) or an "internal transfer identifier". If a single transaction is selected, no other selection criteria are allowed. The sequence can be used only once (repetition is not allowed). Validation: [1..1]
xorShrtBizIdPrtryId		Choice Mandatory	Choice amongst ShrtBizId or PrtryRef Validation: [1..1]
<ShrtBizId>		Short Business Identification Mandatory	Validation: [1..1]
<TxId>-</TxId>	35x	TransactionIdentification Mandatory	Unique and unambiguous identification of a payment transaction, as assigned by the originator. The payment transaction reference is used for reconciliation or to link tasks relating to the payment transaction. TRN of the original payment instruction. If present, all <PmtInstrRef>, <IntrBkValDt> and <InstgAgtId> must be present (HAM business identifier). If present, <PrtrYRef> (Internal transfer identifier) is not allowed. Validation: [1..1]

name of attribute	format	short description	description
<IntrBkSttlmDt>-</IntrBkSttlmDt>	ISODate	Value date	Value date Settlement date (yyyy-mm-dd) If present, all <PmtInstrRef>, <IntrBkValDt> and <InstgAgtId> must be present (HAM business identifier). If present, <PrtryRef> (Internal transfer identifier) is not allowed. Validation: [1..1]
<InstgAgt>		Instructing Agent	Instructing Agent Validation: [1..1]
<FinInstnId>		Financial Institution Identification	Financial Institution Identification Validation: [1..1]
<BICFI>-</BICFI>	4!a2!a2!c3!c	BICFIIdentifier	BICFIIdentifier BIC of the instructing agent (sender of the transaction instruction). If present, all <PmtInstrRef>, <IntrBkValDt> and <InstgAgtId> must be present (HAM business identifier). If present, <PrtryRef> (Internal transfer identifier) is not allowed. Validation: [1..1]
</FinInstnId>		End of Financial Institution Identification	End of Financial Institution Identification Validation: [1..1]
</InstgAgt>		End of Instructing Agent	End of Instructing Agent Validation: [1..1]
</ShrtBizId>		End ShortBusinessIdentification	Validation: [1..1]
<PrtryId>-</PrtryId>	43x	ProprietaryId	ProprietaryId Internal transfer identifier. Unique and unambiguous identifier of a transaction, generated by HAM. If present, <PmtInstrRef>, <IntrBkValDt> and <InstgAgtId> (HAM business identifier) are not allowed. Validation: [1..1]
/xorShrtBizIdPrtryId		End of choice	Validation: [1..1]
</PmtId>		EndPaymentIdentification	End of Set of elements to reference a payment transaction Validation: [1..1]
<ReqdExctnDt>		RequestedExecutionDate	This sequence is used when the requestor wants to select transactions arrived in HAM within a time range. Validation: [0..1]

name of attribute	format	short description	description
xorDtDtTmSch		DateAndDateTimeSearch Choice Optional	Validation:
<DtTmSch>		Date Time Search Mandatory	Validation: [1..1]
xorFrDtTmToDtTmDtTmRg		choice Optional	choice amongst <FrDtTm>, <ToDtTm> or <DtTmRg> Validation:
<FrDtTm>-</FrDtTm>	ISODateTime	FromDate Mandatory	Date and time at which the range starts. Validation: [1..1]
<ToDtTm>-</ToDtTm>	ISODateTime	ToDate Mandatory	Date and time at which the range ends. Validation: [1..1]
<DtTmRg>		DateTimeRange Mandatory	Validation: [1..1]
<FrDtTm>-</FrDtTm>	DateTime	From Date Time Mandatory	Lower bound of the time range (yyyy-mm-ddThh-mm-ss). Validation: [1..1]
<ToDtTm>-</ToDtTm>	DateTime	To Date Time Mandatory	Upper bound of the time range (yyyy-mm-ddThh-mm-ss). Validation: [1..1]
</DtTmRg>		End Date Time Range Mandatory	Validation: [1..1]
/xorFrDtTmToDtTmDtTmRg		End of choice Optional	end of choice amongst <FrDtTm>, or <ToDtTm> or <DtTmRg> Validation:
</DtTmSch>		End Date Time Search Mandatory	Validation: [1..1]
<DtSch>		Date Search Mandatory	Validation: [1..1]
xorDtSch		DateSearchChoice Optional	DateSearchChoice FromDate [1..1] ToDate [1..1] FromToDate [1..1] EqualDate [1..1] Validation:

name of attribute	format	short description	description
<FrToDt>		From To Date Mandatory	Validation: [1..1]
<FrDt>-</FrDt>	ISODate	Date From Mandatory	Validation: [1..1]
<ToDt>-</ToDt>	ISODate	Date Till Mandatory	Date within a particular calendar year represented by YYYY-MM-DD (ISO 8601). Validation: [1..1]
</FrToDt>		End FromToDate Mandatory	Validation: [1..1]
<EQDt>-</EQDt>	Date	Equal Date Mandatory	Validation: [1..1]
/xorDtSch		End Date Search Optional	End Date Search Validation:
</DtSch>		End of Date Search Mandatory	End of Date Search Validation: [1..1]
/xorDtDtTmSch		End of DateAndDateTimeSearch Choice Optional	Validation:
</ReqdExctnDt>		End of RequestedExecutionDate Optional	Validation: [0..1]
<Sts>		PaymentStatus Optional	This sequence is used when the requestor wants to select transactions with a specified status (final or pending) or transactions rejected with a specified error code. It is possible to specify up to a maximum of 3 different status and 3 different error codes. Validation: [0..3]
<PmtInstrSts>		PaymentStatusCode Mandatory	Validation: [1..1]
xorFnlStsPdgSts		Choice Mandatory	Choice amongst FnlSts or PdgSts Validation: [1..1]
<FnlSts>-</FnlSts>	4x	Final Status	Specifies the (final) status of the transactions to select. Possible values are: "CAND" (cancelled) for cancelled transactions; "RJTD" (rejected) for transactions rejected by the clearing agent; "STLD" (settled) for transactions

name of attribute	format	short description	description
		Mandatory	successfully processed. The attributes <FnlSts> and <PdgSts> are mutually exclusive. If <FnlSts> is valorised, <PdgSts> cannot be valorised, and viceversa. Validation: [1..1]
<PdgSts>-</PdgSts>	4x	Pending Status Mandatory	Specifies the (pending) status of the transactions to select. Possible values are: "PSTL " (pending settlement) for queued transactions or "STLE" (earmarked) for transactions delivered in advance. The attributes <PdgSts> and <FnlSts> are mutually exclusive. If <FnlSts> is valorised, <PdgSts> cannot be valorised, and viceversa. Validation: [1..1]
/xorFnlStsPdgSts		End of choice Mandatory	Validation: [1..1]
</PmtInstrSts>		End PaymentStatusCode Mandatory	Validation: [1..1]
<PrtryStsRsn>-</PrtryStsRsn>	4x	Proprietary Status Reason Optional	Specifies the error code of the transactions to select. If used, <FnlSts> must be "RJTD" (rejected). Validation: [0..1]
</Sts>		End of PaymentStatus Optional	Validation: [0..3]
<InstdAmt>		Instructed Amount Optional	This sequence is used when the requestor wants to select transactions with an amount equal, greater, lower than a specified quantity, or included in a specified range. The sequence can be used only once (repetition is not allowed). Validation: [0..1]
<ImpldCcyAndAmtRg>		Implied Currency and Amount Range Mandatory	Validation: [1..1]
<Amt>		Amount Mandatory	Validation: [1..1]
xorFrAmtToAmt FrToAmtEQAmt		Choice Mandatory	Choice amongst FrAmt, ToAmt, FrToAmt or EQAmt . Validation: [1..1]
<FrAmt>		From amount Mandatory	It is used to select transactions with an amount >= than the specified quantity. Validation: [1..1]
<BdryAmt>-</BdryAmt>	14n	Boundary Amount	Amount .

name of attribute	format	short description	description
		Mandatory	Validation: [1..1]
<Incl>-</Incl>	1n	Inclusive flag Mandatory	It must be: "1" (equal is included). Validation: [1..1]
</FrAmt>		End from amount Mandatory	Validation: [1..1]
<ToAmt>		To Amount Mandatory	It is used to select transactions with an amount < than the specified quantity. Validation: [1..1]
<BdryAmt>-</BdryAmt>	14n	Boundary Amount Mandatory	Amount . Validation: [1..1]
<Incl>-</Incl>	1n	Inclusive flag Mandatory	It must be: "0" (equal is not included). Validation: [1..1]
</ToAmt>		End To Amount Mandatory	Validation: [1..1]
<FrToAmt>		FromToAmount Mandatory	It is used to select transactions with an amount included in a specified range. Validation: [1..1]
<FrAmt>		From amount Mandatory	Validation: [1..1]
<BdryAmt>-</BdryAmt>	14n	Boundary Amount Mandatory	Lower bound of the range . Validation: [1..1]
<Incl>-</Incl>	1n	Inclusive flag Mandatory	It must be: "1" (equal is included). Validation: [1..1]
</FrAmt>		End from amount Mandatory	Validation: [1..1]
<ToAmt>		To Amount Mandatory	Validation: [1..1]
<BdryAmt>-</BdryAmt>	14n	Boundary Amount Mandatory	Upper bound of the range Validation:

name of attribute	format	short description	description
			[1..1]
<Incl>-</Incl>	1n	Inclusive flag Mandatory	It must be: "0" (equal is not included) Validation: [1..1]
</ToAmt>		End To Amount Mandatory	Validation: [1..1]
</FrToAmt>		End From To Amount Mandatory	Validation: [1..1]
<EQAmt>-</EQAmt>	14n	Equal Amount Mandatory	It is used to select transactions with an amount = the specified quantity . Validation: [1..1]
/xorFrAmtToAmt FrToAmtEQAmt		End of choice Mandatory	Validation: [1..1]
</Amt>		End of Amount Mandatory	Validation: [1..1]
</ImpldCcyAndAmtRg>		End ImpliedCurrencyandAmount Range Mandatory	Validation: [1..1]
</InstdAmt>		End Instructed Amount Optional	Validation: [0..1]
<CdtDbtInd>-</CdtDbtInd>	4!a	Credit or debit indicator Optional	Credit debit indicator. The attribute is mandatory except in the case of selection of a single transaction identified via an internal or a business identifier. When valorised, it can be: "CRDT" (credit) or "DBIT" (debit). Validation: [0..1]
<PmtMtd>		PaymentMethod Optional	PaymentMethod This sequence is used to select transactions triggered by the arrival of a specific SWIFT FIN message. If not used, transactions triggered by all FIN messages (MT 202, MT 103 and MT103+) will be returned. Validation: [0..1]
<FINMT>-</FINMT>	3x	FIN Message Type Mandatory	103 202 204 It is used to specify a SWIFT FIN message. Possible values are: "202" (MT202) or "103" (MT103 and MT103+). Validation: [1..1]
</PmtMtd>		End Payment Method	

name of attribute	format	short description	description
		Optional	Validation: [0..1]
<PrcgVldtyTm>		ProcessingValidityTime	This sequence is used when the requestor wants to select transactions finalized in HAM before or after a specific time or within a time range.
		Optional	Validation: [0..1]
xorFrDtTmToDtTmDtTmRg		choice	choice amongst <FrDtTm>, <ToDtTm> or <DtTmRg>
		Mandatory	Choice between FrDtTm, ToDtTm and DtTmRg Validation: [1..1]
<FrDtTm>-</FrDtTm>	DateTime	From Date Time	Used to select transactions finalized in HAM after a specific time
		Mandatory	Validation: [1..1]
<ToDtTm>-</ToDtTm>	DateTime	To Date Time	Used to select transactions finalized in HAM before a specific time
		Mandatory	Validation: [1..1]
<DtTmRg>		DateTimeRange	
		Mandatory	Validation: [1..1]
<FrDtTm>-</FrDtTm>	DateTime	From Date Time	Lower bound of the time range (yyyy-mm-ddThh-mm-ss).
		Mandatory	Validation: [1..1]
<ToDtTm>-</ToDtTm>	DateTime	To Date Time	Upper bound of the time range (yyyy-mm-ddThh-mm-ss).
		Mandatory	Validation: [1..1]
</DtTmRg>		End Date Time Range	
		Mandatory	Validation: [1..1]
/xorFrDtTmToDtTmDtTmRg		End of choice	end of choice amongst <FrDtTm>, or <ToDtTm> or <DtTmRg>
		Mandatory	Validation: [1..1]
</PrcgVldtyTm>		End Processing Validity Time	
		Optional	Validation: [0..1]
<PmtTp>		Payment Type	Payment Type
		Optional	This sequence is used when the requestor wants to select transactions of a specific type. The sequence can be used up to 3 times. Validation: [0..3]
<Prtry>-</Prtry>		ProprietaryPaymentTypeCode	Proprietary Payment Type

name of attribute	format	short description	description
			<p>REGP = Regular Payment CONP = Connected Payment BACP = Backup Payment LIQP = Liquidity transfer via payments ASYP = Ancillary Systems Payments MANP= mandated payment INTP = interests PDDB = penalties BIDB = billing T2SL = T2S transactions TIPS = TIPS transactions</p> <p>Specifies the type of transactions. Possible values are: "CWD" (Cash Withdrawals); "LQT" (Liquidity Transfers) for transfers between accounts of the same participant, (including standing facilities transactions); "RGT" (Regular Transactions) for transfers between HAM accounts, or between HAM accounts and RTGS accounts of different participants; "RGP" (Regular Payments) for payments between CB customers, or between CB customers and RTGS accounts, or between CB customers and the account in HAM of the NCB (initiated by the NCB via Simplified MT 202); "BKT" (back up transactions) for transactions initiated by the NCB via ICM on behalf of the account owner in contingency situations; "HAM" (interests from HAM); "SFM" (interests from SF Module); "CRM" (billing from CRM); "RMM" (interests/penalties from RM module).</p>
		Mandatory	Validation: [1..1]
</PmtTp>		End Payment Type	
		Optional	Validation: [0..3]
<Txld>-</Txld>	35x	TransactionIdentification	<p>Unique and unambiguous identification of a payment transaction, as assigned by the originator. The payment transaction reference is used for reconciliation or to link tasks relating to the payment transaction.</p> <p>This attribute is used to select transactions with a specific TRN.</p>
		Optional	Validation: [0..1]
/xorInstrRefGenericCriteria		End of choice	
		Mandatory	Validation: [1..1]
</PmtSch>		End Payment Search	
		Optional	Validation: [0..1]
<AcctNtrySch>		Account Entry Search	
		Optional	Validation: [0..1]
<AcctId>		Account Identification	<p>Account Identification</p> <p>This sequence must be used when requesting information about a CB customer, in order to univocally identify the CB customer account (through the country code of the relevant Central Bank). It is mandatory when the requested CB customer holds accounts at different Central Banks with the same BIC. It can be used only once (repetition is not allowed).</p>
		Optional	Validation: [0..1]
<CTTxt>-</CTTtxt>	2x	Country code	<p>Specifies the country code of the Central Bank relevant for the CB customer account.</p>

name of attribute	format	short description	description	
		Mandatory	Validation: [1..1]	
</AcctId>		End of Account Identification Optional	Validation: [0..1]	
<NtryDt>		Entry Date Optional	Validation: [0..1]	
xorDtDtTmSch		DateAndDateTimeSearch Choice Optional	Validation:	
<DtTmSch>		DateTimePeriodChoice	A choice between various date time patterns.	
			FromDateTime [1..1] ToDateTime [1..1] DateTimeRange [1..1]	DateTimePeriodChoice DateTimePeriodChoice DateTimePeriodChoice
		Mandatory	Validation: [1..1]	
xorFrDtTmToDtTmDtTmRg		choice Optional	choice amongst <FrDtTm>, <ToDtTm> or <DtTmRg> Validation:	
<FrDtTm>-</FrDtTm>	ISODateTime	FromDateTime Mandatory	Date and time at which the range starts. Validation: [1..1]	
<ToDtTm>-</ToDtTm>	ISODateTime	ToDateTime Mandatory	Date and time at which the range ends. Validation: [1..1]	
<DtTmRg>		DateTimeRange Mandatory	Range of time between a start date and time and an end date and time. Validation: [1..1]	
<FrDtTm>-</FrDtTm>	ISODateTime	FromDateTime Mandatory	Date and time at which the range starts. Validation: [1..1]	
<ToDtTm>-</ToDtTm>	ISODateTime	ToDateTime Mandatory	Date and time at which the range ends. Validation: [1..1]	
</DtTmRg>		End Date Time Range Mandatory	Validation: [1..1]	
/xorFrDtTmToDtTmDtTmRg		End of choice Optional	end of choice amongst <FrDtTm>, or <ToDtTm> or <DtTmRg> Validation:	

name of attribute	format	short description	description
</DtTmSch>		End of DateTimePeriodChoice Mandatory	End of DateTimePeriodChoice Validation: [1..1]
<DtSch>		Date Search Mandatory	Validation: [1..1]
xorFrToDtEQDt		Choice Mandatory	Choice amongst FrToDt or EQDt. Validation: [1..1]
<FrToDt>		From To Date Mandatory	It is used to select transactions to be settled in a specific date range. Validation: [1..1]
<FrDt>-</FrDt>	DateTime	Start Date Mandatory	Lower bound of the range (yyyy-mm-dd). Validation: [1..1]
<ToDt>-</ToDt>	Date	End Date Mandatory	Upper bound of the range (yyyy-mm-dd). Validation: [1..1]
</FrToDt>		End FromToDate Mandatory	Validation: [1..1]
<EQDt>-</EQDt>	Date	Equal Date Mandatory	It is used to select transactions to be settled in a specific date (yyyy-mm-dd). Validation: [1..1]
/xorFrToDtEQDt		End of choice Mandatory	Validation: [1..1]
</DtSch>		End Date Search Mandatory	Validation: [1..1]
/xorDtDtTmSch		End of DateAndDateTimeSearch Choice Optional	Validation:
</NtryDt>		End Entry Date Optional	Validation: [0..1]
</AcctNtrySch>		End AccountEntrySearch Optional	Validation: [0..1]
</SchCrit>		End of SearchCriteria Mandatory	Validation:

name of attribute	format	short description	description
			[0..1]
</NewCrit>		End of NewCriteria Mandatory	Validation: [1..1]
/xorQryNmNewCrit		End choice amongst Mandatory	end choice amongst TransactionCriteriaDefinitionChoice Validation: [1..1]
</TxCrit>		End Transaction Criteria Mandatory	Validation: [0..1]
</TxQryDef>		End Transaction Query Definition Mandatory	Validation: [0..1]
</GetTx>		End of Messagename for GetTransaction Mandatory	Validation: [1..1]

Error Codes:

Order	Error code				Error Text / Validation/ Remark
	SSP	Y-copy	V-shape	XML	
1	X41			1401	Error Text: No permission. RBAC User role(s) are not sufficient. Validation: RBAC role name "APPLICATE", "APPLICSTE" or "APPLICBTE" are required Remark: checked by ICM / ReturnTransaction
2	866	C6	AC06	2866	Error Text: Exclusion of participant Validation: Remark:
3	852	B2	XI12	2852	Error Text: Invalid character or invalid numeric value Validation: Remark:
4	H13			H013	Error Text: Requested field missing in input Validation: Remark:
5	866	C6	AC06	2866	Error Text: Exclusion of participant Validation: Remark:
6	H14			H014	Error Text: Requested country code missing in input Validation: Remark:
7	H11			H011	Error Text: Requested BIC unknown Validation: Remark:
8	H09			H009	Error Text: Parameter logical error <.> Validation: Remark:
9	H08			H008	Error Text: Requestor unknown Validation: Remark:
10	H06			H006	Error Text: No data available (e.g. an empty list) Validation: Remark:
11	H01		XI01	H001	Error Text: Sender not allowed Validation: Remark:
12	H12			H012	Error Text: Requested BIC missing in input Validation: Remark:

Order	Error code				Error Text / Validation/ Remark
	SSP	Y-copy	V-shape	XML	
13	H04	M4	XT16	H004	Error Text: Operation not allowed (e.g. cross border) Validation: Remark:

GetTransaction_HAM_1

Scope: Request of information on a specific transaction identified through a HAM business identifier . The requestor is the account owner.

MessageName for GetTransaction	<GetTx>
Message Header	<MsgHdr>
Message Identification	<MsgId>HACDEFGHIJKLMNOPQRST123456789012345</MsgId>
End of Message Header	</MsgHdr>
Transaction Query Definition	<TxQryDef>
Transaction Criteria	<TxCrit>
NewCriteria	<NewCrit>
SearchCriteria	<SchCrit>
Payment Search	<PmtSch>
PaymentIdentification	<PmtId>
Short Business Identification	<ShrtBizId>
TransactionIdentification	<TxId>ABCDEFGHIL123456</TxId>
Value date	<IntrBkSttlmDt>2008-09-12</IntrBkSttlmDt>
Instructing Agent	<InstgAgt>
Financial Institution Identification	<FinInstnId>
BICFIIdentifier	<BICFI>BBBBITRRXXX</BICFI>
End of Financial Institution Identification	</FinInstnId>
End of Instructing Agent	</InstgAgt>
End ShortBusinessIdentification	</ShrtBizId>
EndPaymentIdentification	</PmtId>
End Payment Search	</PmtSch>
End of SearchCriteria	</SchCrit>
End of NewCriteria	</NewCrit>
End Transaction Criteria	</TxCrit>
End Transaction Query Definition	</TxQryDef>
End of MessageName for GetTransaction	</GetTx>

M

GetTransaction_HAM_2

Scope: Request of information on all settled credit transactions. The requestor is the co-manager of the account owner.

Messagename for GetTransaction	<GetTx>
Message Header	<MsgHdr>
Message Identification	<MsgId>HACDEFGHIJKLMNOPQRST123456789012345</MsgId>
End of Message Header	</MsgId>
Transaction Query Definition	<TxQryDef>
Transaction Criteria	<TxCrit>
NewCriteria	<NewCrit>
SearchCriteria	<SchCrit>
PaymentTo	<PmtTo>
Member Identification	<Mmbld>
Financial Institution Identification	<FinInstnId>
BICFIIdentifier	<BICFI>BBBBITRRXX</BICFI>
End of Financial Institution Identification	</FinInstnId>
End Member Identification	</Mmbld>
End PaymentTo	</PmtTo>
Payment Search	<PmtSch>
PaymentStatus	<Sts>
PaymentStatusCode	<PmtInstrSts>
Final Status	<FnlSts>STLD</FnlSts>
End PaymentStatusCode	</PmtInstrSts>
End of PaymentStatus	</InstrSts>
Credit or debit indicator	<CdtDbtInd>CRDT</CdtDbtInd>
End Payment Search	</PmtSch>
End of SearchCriteria	</SchCrit>
End of NewCriteria	</NewCrit>
End Transaction Criteria	</TxCrit>
End Transaction Query Definition	</TxQryDef>
End of Messagename for GetTransaction	</GetTx>

GetTransaction _HAM_3

Scope: Request of information on all debit transactions sent by the co-manager (BBBBITRRXXX) on behalf of the account owner (PPPPITRRXXX).

MessageName for GetTransaction	<GetTx>
Message Header	<MsgHdr>
Message Identification	<MsgId>HACDEFGHIJKLMNOPQRST123456789012345</MsgId>
End of Message Header	</MsgHdr>
Transaction Query Definition	<TxQryDef>
Transaction Criteria	<TxCrit>
NewCriteria	<NewCrit>
SearchCriteria	<SchCrit>
Payment From	<PmtFr>
Member Identification	<Mmbld>
Financial Institution Identification	<FinInstnId>
BICFIIdentifier	<BICFI>PPPPITRRXXX</BICFI>
End of Financial Institution Identification	</FinInstnId>
End Member Identification	</Mmbld>
End Payment From	</PmtFr>
Payment From	<PmtFr>
Member Identification	<Mmbld>
Financial Institution Identification	<FinInstnId>
BICFIIdentifier	<BICFI>BBBBITRRXXX</BICFI>
End of Financial Institution Identification	</FinInstnId>
End Member Identification	</Mmbld>
End Payment From	</PmtFr>
Payment Search	<PmtSch>
Credit or debit indicator	<CdtDbtInd>DBIT</CdtDbtInd>
End Payment Search	</PmtSch>
End of SearchCriteria	</SchCrit>
End of NewCriteria	</NewCrit>
End Transaction Criteria	</TxCrit>
End Transaction Query Definition	</TxQryDef>
End of MessageName for GetTransaction	</GetTx>

GetTransaction_HAM_4

Scope: Request of information about the FIN message that triggered a single transaction identified through a HAM business identifier.

Messagename for GetTransaction	<GetTx>
Message Header	<MsgHdr>
Message Identification	<MsgId>HACDEFGHIJKLMNOPQRST123456789012345</MsgId>
End of Message Header	</MsgHdr>
Transaction Query Definition	<TxQryDef>
Transaction Criteria	<TxCrit>
NewCriteria	<NewCrit>
SearchCriteria	<SchCrit>
PaymentTo	<PmtTo>
SystemIdentification	<SysId>
ExternalCashClearingSystemCode	<Cd>TGT</Cd>
End of SystemIdentification	</SysId>
End PaymentTo	</PmtTo>
Payment Search	<PmtSch>
PaymentIdentification	<PmtId>
Short Business Identification	<ShrtBizId>
TransactionIdentification	<TxId>ABCDEFGHIL123456</TxId>
Value date	<IntrBkSttlmDt>2008-09-12</IntrBkSttlmDt>
Instructing Agent	<InstgAgt>
Financial Institution Identification	<FinInstnId>
BICFIIdentifier	<BICFI>BBBBITRRXXX</BICFI>
End of Financial Institution Identification	</FinInstnId>
End of Instructing Agent	</InstgAgt>
End ShortBusinessIdentification	</ShrtBizId>
EndPaymentIdentification	</PmtId>
End Payment Search	</PmtSch>
End of SearchCriteria	</SchCrit>
End of NewCriteria	</NewCrit>
End Transaction Criteria	</TxCrit>
End Transaction Query Definition	</TxQryDef>
Messagename for GetTransaction	</GetTx>

GetTransaction_HAM_5

Scope: Request of information on all debit Regular Transactions (RGT): sent by the co-manager (SSSSITRRXXX), on behalf of the account owner (OOOOITRRXXX), towards a country (DE), arrived in HAM in a range of time (2008-05-02T10-00-00 - 2008-05-02T10-04-59), to be settled in the same date, rejected with a specific return code (XI02), in a range of amount (1000000,01 - 1000100,00).

MessageName for GetTransaction	<GetTx>
Message Header	<MsgHdr>
Message Identification	<MsgId>ABCDEFGHIJLMNOPQRSTUVWXYZ0123456789</MsgId>
End of Message Header	</MsgHdr>
Transaction Query Definition	<TxQryDef>
Transaction Criteria	<TxCrit>
NewCriteria	<NewCrit>
SearchCriteria	<SchCrit>
PaymentTo	<PmtTo>
Country Code	<Ctry>DE</Ctry>
End PaymentTo	</PmtTo>
Payment From	<PmtFr>
Member Identification	<MmblId>
Financial Institution Identification	<FinInstId>
BICFIIdentifier	<BICFI>OOOOITRRXXX</BICFI>
End of Financial Institution Identification	</FinInstId>
End Member Identification	</MmblId>
End Payment From	</PmtFr>
Payment From	<PmtFr>
Member Identification	<MmblId>
Financial Institution Identification	<FinInstId>
BICFIIdentifier	<BICFI>SSSSITRRXXX</BICFI>
End of Financial Institution Identification	</FinInstId>
End Member Identification	</MmblId>
End Payment From	</PmtFr>
Payment Search	<PmtSch>
RequestedExecutionDate	<ReqdExctnDt>
Date Time Search	<DtTmSch>
DateTimeRange	<DtTmRg>
From Date Time	<FrDtTm>2007-08-13T08:30:00</FrDtTm>
To Date Time	<ToDtTm>2007-08-13T08:50:00</ToDtTm>
End Date Time Range	</DtTmRg>
End Date Time Search	</DtTmSch>
End of RequestedExecutionDate	</ReqdExctnDt>
PaymentStatus	<Sts>
PaymentStatusCode	<PmtInstrSts>
Final Status	<FnlSts>RJTD</FnlSts>
End PaymentStatusCode	</PmtInstrSts>
Proprietary Status Reason	<PrtryStsRsn>XI02</PrtryStsRsn>
End of PaymentStatus	</Sts>
Instructed Amount	<InstdAmt>
Implied Currency and Amount Range	<ImpldCcyAndAmtRg>
Amount	<Amt>
FromToAmount	<FrToAmt>
From amount	<FrAmt>
Boundary Amount	<BdryAmt>1000000.01</BdryAmt>
Inclusive flag	<Incl>1</Incl>
End from amount	</FrAmt>

To Amount	<ToAmt>
Boundary Amount	<BdryAmt>1000100.00</BdryAmt>
Inclusive flag	<Incl>0</Incl>
End To Amount	</ToAmt>
End From To Amount	</FrToAmt>
End of Amount	</Amt>
End ImpliedCurrencyandAmount Range	</ImpldCcyAndAmtRg>
End Instructed Amount	</InstdAmt>
Credit or debit indicator	<CdtDbtInd>DBIT</CdtDbtInd>
Payment Type	<PmtTp>
ProprietaryPaymentTypeCode	<Prtry>RGT</Prtry>
End Payment Type	</PmtTp>
End Payment Search	</PmtSch>
Account Entry Search	<AcctNtrySch>
Entry Date	<NtryDt>
Date Search	<DtSch>
Equal Date	<EQDt>2008-05-02</EQDt>
End Date Search	</DtSch>
End Entry Date	</NtryDt>
End AccountEntrySearch	</AcctNtrySch>
End of SearchCriteria	</SchCrit>
End of NewCriteria	</NewCrit>
End Transaction Criteria	</TxCrit>
End Transaction Query Definition	</TxQryDef>
End of Messagename for GetTransaction	</GetTx>

6.7.7 LiquidityCreditTransfer

Cash Management Standard

LiquidityCreditTransfer_HAM

Scope: The Liquidity Credit Transfer message is used by HAM account holders (or by Co-managers and NCBs on behalf of the HAM account holder) to perform: 1) liquidity transfers from the HAM account to the RTGS account of the same participant; 2) interbank transfers between HAM accounts or from the HAM account to the RTGS account of different participants.

It is also used by NCBs to perform: 1) transfers between CB customers' accounts; 2) transfers from CB cutomers' accounts to RTGS accounts (including the account of the NCB); 3) transfers between CB customers' accounts and the account in HAM of the NCB.

This message will be replied by a Receipt message.

Non repudiation of emission (NRE) is supported.

<camt.050.001.xx>

Structure:

Message name for LiquidityCreditTransfer	<LqdyCdtTrf>
Message Header	<MsgHdr>
Message Identification	<MsgId></MsgId>
End of Message Header	</MsgHdr>
LiquidityCreditTransfer1	<LqdyCdtTrf>
CreditorAccount	<CdtrAcct>
Identification	<Id>
GenericAccountIdentification	<Othr>
Identification	<Id></Id>
End of GenericAccountIdentification	</Othr>
End Identification	</Id>
CashAccountType	<Tp>
ExternalCashAccountTypeCode	<Cd></Cd>
End of CashAccountType	</Tp>
EndCreditorAccount	</CdtrAcct>
Amount	<TrfdAmt>
Amount without currency	<AmtWthtCcy></AmtWthtCcy>
End of Transferred Amount	</TrfdAmt>
DebtorAccount	<DbtrAcct>
Identification	<Id>
GenericAccountIdentification	<Othr>
Identification	<Id></Id>
End of GenericAccountIdentification	</Othr>
End Identification	</Id>
CashAccountType	<Tp>
ExternalCashAccountTypeCode	<Cd></Cd>
End of CashAccountType	</Tp>
EndDebtorAccount	</DbtrAcct>
End of LiquidityCreditTransfer1	</LqdyCdtTrf>
End message name LiquidityCreditTransfer	</LqdyCdtTrf>

Attributes:

name of attribute	format	short description	description
<LqdyCdtTrf>		Message name for LiquidityCreditTransfer Mandatory	Message name for LiquidityCreditTransfer Validation: [1..1]
<MsgHdr>		Message Header Mandatory	Set of characteristics specific to the message Validation: [1..1]
<MsgId>-</MsgId>	35x	Message Identification Mandatory	Message Identification String of characters that uniquely identifies a message at senders side. The first 16 characters must be unique (TRN) and consistent with "X SWIFT Character Set", including exceptions as per SWIFT "Message Format Validations Rules" related to field 20 and 21. Validation: [1..1]
</MsgHdr>		End of Message Header Mandatory	Validation: [1..1]
<LqdyCdtTrf>		LiquidityCreditTransfer1 Mandatory	LiquidityCreditTransfer Validation: [1..1]
<CdtrAcct>		CreditorAccount Mandatory	Validation: [1..1]
<Id>		Identification Mandatory	Validation: [1..1]
<Othr>		GenericAccountIdentification Mandatory	GenericAccountIdentification Validation: [1..1]
<Id>-</Id>	34x	Identification Mandatory	Name or number assigned by an entity to enable recognition of that entity, eg, account identifier. BIC of the account to be credited. If the account to be credited belongs to a CB customer, the attribute contains not only the BIC of the CB customer but also the country code of the relevant CB for that account. In this case the format is: BIC (11x) followed by country code (2x). Validation: [1..1]
</Othr>		End of GenericAccountIdentification Mandatory	End of GenericAccountIdentification Validation: [1..1]
</Id>		End Identification Mandatory	Validation: [1..1]
<Tp>		CashAccountType	CashAccountType

name of attribute	format	short description	description
		Mandatory	Validation: [1..1]
<Cd>-</Cd>		ExternalCashAccountType Code	ExternalCashAccountTypeCode SSP restricted code list: CACC = Current Account used to post debits and credits when no specific account has been nominated SACC = Settlement Account used to post debit and credit entries, as a result of transactions cleared and settled through a specific clearing and settlement system. Type of the account to be credited. It can be: "CACC" (account in HAM) or "SACC" (RTGS account).
		Mandatory	Validation: [1..1]
</Tp>		End of CashAccountType	End of CashAccountType
		Mandatory	Validation: [1..1]
</CdtrAcct>		EndCreditorAccount	
		Mandatory	Validation: [1..1]
<TrfdAmt>		Amount	
		Mandatory	Validation: [1..1]
<AmtWthtCcy>- </AmtWthtCcy>	14n	Amount without currency	Amount .
		Mandatory	Validation: [1..1]
</TrfdAmt>		End of Transferred Amount	
		Mandatory	Validation: [1..1]
<DbtrAcct>		DebtorAccount	
		Mandatory	Validation: [1..1]
<Id>		Identification	
		Mandatory	Validation: [1..1]
<Othr>		GenericAccountIdentificatio n	GenericAccountIdentification
		Mandatory	Validation: [1..1]
<Id>-</Id>	34x	Identification	Name or number assigned by an entity to enable recognition of that entity, eg, account identifier. BIC of the account to be debited. If the account to be debited belongs to a CB customer, the attribute contains not only the BIC of the CB customer but also the country code of the relevant CB for that account. In this case the format is: BIC (11x) followed by country code (2x).
		Mandatory	Validation: [1..1]

name of attribute	format	short description	description
</Othr>		End of GenericAccountIdentification Mandatory	End of GenericAccountIdentification Validation: [1..1]
</Id>		End Identification Mandatory	Validation: [1..1]
<Tp>		CashAccountType Mandatory	CashAccountType Validation: [1..1]
<Cd>-</Cd>		ExternalCashAccountType Code Mandatory	ExternalCashAccountTypeCode SSP restricted code list: CACC = Current Account used to post debits and credits when no specific account has been nominated SACC = Settlement Account used to post debit and credit entries, as a result of transactions cleared and settled through a specific clearing and settlement system. Type of the account to be debited. It can be: "CACC" (account in HAM) or, only in case of cash withdrawals, "CASH" (account in HAM using the liquidity reserved for cash withdrawals). Validation: [1..1]
</Tp>		End of CashAccountType Mandatory	End of CashAccountType Validation: [1..1]
</DbtrAcct>		EndDebtorAccount Mandatory	Validation: [1..1]
</LqdyCdtTrf>		End of LiquidityCreditTransfer1 Mandatory	End of LiquidityCreditTransfer Validation: [1..1]
</LqdyCdtTrf>		End message name LiquidityCreditTransfer Mandatory	End message name LiquidityCreditTransfer Validation: [1..1]

Error Codes:

Order	Error code				Error Text / Validation/ Remark
	SSP	Y-copy	V-shape	XML	
1	X41			1401	Error Text: No permission. RBAC User role(s) are not sufficient. Validation: RBAC role name "APPLICATE", "APPLICSTE" or "APPLICBTE" are required Remark: checked by ICM / Receipt
2	X44			1404	Error Text: If "non repudiation of emission" is mandatory, the NRE indicator flag has to be present Validation: If non-repudiaton processing is mandatory, the tag <SwInt:NRIndicator>TRUE</SwInt:NRIndicator> has to be present. Remark: Receipt /checked by ICM
3	868	C8	XI19	2868	Error Text: Invalid sending/receiving BIC Validation: Remark:
4	866	C6	AC06	2866	Error Text: Exclusion of participant Validation: Remark:
5	862	C2	TM01	2862	Error Text: Request out of cut-off time Validation: Remark:
6	861	C1	RF01	2861	Error Text: Double input Validation: Remark:
7	850	B0	XI00	2850	Error Text: Generic error Validation: Remark:
10	H14			H014	Error Text: Requested country code missing in input Validation: Remark:
11	H08			H008	Error Text: Requestor unknown Validation: Remark:
12	H07	M7		H007	Error Text: Account not open Validation: Remark:
13	H02		XI04	H002	Error Text: Debit account not open Validation: Remark:
14	H01		XI01	H001	Error Text: Sender not allowed Validation:

Order	Error code				Error Text / Validation/ Remark
	SSP	Y-copy	V-shape	XML	

Remark:

LiquidityCreditTransfer_HAM_1

Scope: Liquidity transfer from the HAM account (debtor) to the RTGS account (creditor) of the same participant.

Message name for LiquidityCreditTransfer	<LqdyCdtTrf>
Message Header	<MsgHdr>
Message Identification	<MsgId>ABCDEFGHIJKLMNQRST123456789012345</MsgId>
End of Message Header	</MsgHdr>
LiquidityCreditTransfer1	<LqdyCdtTrf>
CreditorAccount	<CdtrAcct>
Identification	<Id>
GenericAccountIdentification	<Othr>
Identification	<Id>BBBBITRRXX</Id>
End of GenericAccountIdentification	</Othr>
End Identification	</Id>
CashAccountType	<Tp>
ExternalCashAccountTypeCode	<Cd>SACC</Cd>
End of CashAccountType	</Tp>
EndCreditorAccount	</CdtrAcct>
Amount	<TrfdAmt>
Amount without currency	<AmtWthtCcy>1234.56</AmtWthtCcy>
End of Transferred Amount	</TrfdAmt>
DebtorAccount	<DbtrAcct>
Identification	<Id>
GenericAccountIdentification	<Othr>
Identification	<Id>BBBBITRRXX</Id>
End of GenericAccountIdentification	</Othr>
End Identification	</Id>
CashAccountType	<Tp>
ExternalCashAccountTypeCode	<Cd>CACC</Cd>
End of CashAccountType	</Tp>
EndDebtorAccount	</DbtrAcct>
End of LiquidityCreditTransfer1	</LqdyCdtTrf>
End message name LiquidityCreditTransfer	</LqdyCdtTrf>

LiquidityCreditTransfer_HAM_2

Scope: Liquidity transfer from the HAM account (debtor) to another HAM account (creditor).

Message name for LiquidityCreditTransfer	<LqdyCdtTrf>
Message Header	<MsgHdr>
Message Identification	<MsgId>HACDEFGHIJKLMNOPQRST123456789012345</MsgId>
End of Message Header	</MsgId>
LiquidityCreditTransfer1	<LqdyCdtTrf>
CreditorAccount	<CdtrAcct>
Identification	<Id>
GenericAccountIdentification	<Othr>
Identification	<Id>CCCCITMMXX</Id>
End of GenericAccountIdentification	</Othr>
End Identification	</Id>
CashAccountType	<Tp>
ExternalCashAccountTypeCode	<Cd>CACC</Cd>
End of CashAccountType	</Tp>
EndCreditorAccount	</CdtrAcct>
Amount	<TrfdAmt>
Amount without currency	<AmtWthtCcy>1234.56</AmtWthtCcy>
End of Transferred Amount	</TrfdAmt>
DebtorAccount	<DbtrAcct>
Identification	<Id>
GenericAccountIdentification	<Othr>
Identification	<Id>DDDDITRRXX</Id>
End of GenericAccountIdentification	</Othr>
End Identification	</Id>
CashAccountType	<Tp>
ExternalCashAccountTypeCode	<Cd>CACC</Cd>
End of CashAccountType	</Tp>
EndDebtorAccount	</DbtrAcct>
End of LiquidityCreditTransfer1	</LqdyCdtTrf>
End message name LiquidityCreditTransfer	</LqdyCdtTrf>

LiquidityCreditTransfer_HAM_3

Scope: Cash withdrawal operation: transfer from the HAM account of the participant (debtor) to the HAM account of the relevant NCB (creditor).

Message name for LiquidityCreditTransfer	<LqdyCdtTrf>
Message Header	<MsgHdr>
Message Identification	<MsgId>ABCDEFGHIJKLMNQRST123456789012345</MsgId>
End of Message Header	</MsgHdr>
LiquidityCreditTransfer1	<LqdyCdtTrf>
CreditorAccount	<CdtrAcct>
Identification	<Id>
GenericAccountIdentification	<Othr>
Identification	<Id>BITAITRRXXX</Id>
End of GenericAccountIdentification	</Othr>
End Identification	</Id>
CashAccountType	<Tp>
ExternalCashAccountTypeCode	<Cd>CACC</Cd>
End of CashAccountType	</Tp>
EndCreditorAccount	</CdtrAcct>
Amount	<TrfdAmt>
Amount without currency	<AmtWthtCcy>1234.56</AmtWthtCcy>
End of Transferred Amount	</TrfdAmt>
DebtorAccount	<DbtAcct>
Identification	<Id>
GenericAccountIdentification	<Othr>
Identification	<Id>BBBBITRRXXX</Id>
End of GenericAccountIdentification	</Othr>
End Identification	</Id>
CashAccountType	<Tp>
ExternalCashAccountTypeCode	<Cd>CASH</Cd>
End of CashAccountType	</Tp>
EndDebtorAccount	</DbtAcct>
End of LiquidityCreditTransfer1	</LqdyCdtTrf>
End message name LiquidityCreditTransfer	</LqdyCdtTrf>

LiquidityCreditTransfer_HAM_4

Scope: Transfer between two CB Customers; the requestor is the NCB responsible for the CB Customer to be debited. The country code of the NCB responsible for the CB customer to be debited (AAAAPPZZXXX) is "IT" while the country code of the NCB responsible for the CB customer to be credited (BBBBGGRRXXX) is "DE".

Message name for LiquidityCreditTransfer	<LqdyCdtTrf>
Message Header	<MsgHdr>
Message Identification	<MsgId>HACDEFGHIJKLMNOPQRST123456789012345</MsgId>
End of Message Header	</MsgHdr>
LiquidityCreditTransfer1	<LqdyCdtTrf>
CreditorAccount	<CdtrAcct>
Identification	<Id>
GenericAccountIdentification	<Othr>
Identification	<Id>AAAAPPZZXXXDE</Id>
End of GenericAccountIdentification	</Othr>
End Identification	</Id>
CashAccountType	<Tp>
ExternalCashAccountTypeCode	<Cd>CACC</Cd>
End of CashAccountType	</Tp>
EndCreditorAccount	</CdtrAcct>
Amount	<TrfdAmt>
Amount without currency	<AmtWthtCcy>1234.56</AmtWthtCcy>
End of Transferred Amount	</TrfdAmt>
DebtorAccount	<DbtrAcct>
Identification	<Id>
GenericAccountIdentification	<Othr>
Identification	<Id>BBBBGGRRXXXIT</Id>
End of GenericAccountIdentification	</DmstAcct>
End Identification	</Id>
CashAccountType	<Tp>
ExternalCashAccountTypeCode	<Cd>CACC</Cd>
End of CashAccountType	</Tp>
EndDebtorAccount	</DbtrAcct>
End of LiquidityCreditTransfer1	</LqdyCdtTrf>
End message name LiquidityCreditTransfer	</LqdyCdtTrf>

6.7.8 ModifyReservation

Cash Management Standard

ModifyReservation_HAM

Scope: The Modify Reservation Message is used by HAM account holders (or by Co-managers and NCBs on behalf of the HAM account holder) to modify the reservation for cash withdrawals (current or default). It is also used by NCBs to modify the value of the threshold for advice of investment for CB customers. This message will be replied by a Receipt message. Non repudiation of emission (NRE) is supported.

<camt.048.001.xx>

Structure:

Messsge name for ModifyReservation	<ModifyRsvatn>
Message Header	<MsgHdr>
Message Identification	<MsgId></MsgId>
End of Message Header	</MsgHdr>
CurrentOrDefaultReservation	<RsvatnId>
choice	xorCurRsvatnIdDfltRsvatnId
CurrentReservationId	<Cur>
ReservationType	<Tp>
ReservationTypeCode	<Cd></Cd>
End of ReservationType	</Tp>
Account Owner	<AcctOwnr>
Financial Institution Identification	<FinInstnId>
BICFIIdentifier	<BICFI></BICFI>
End of Financial Institution Identification	</FinInstnId>
End of Account owner	</AcctOwnr>
End of CurrentReservationId	</Cur>
ReservationIdentification	<Dflt>
ReservationType	<Tp>
ReservationTypeCode	<Cd></Cd>
End of ReservationType	</Tp>
Account Owner	<AcctOwnr>
Financial Institution Identification	<FinInstnId>
BICFIIdentifier	<BICFI></BICFI>
End of Financial Institution Identification	</FinInstnId>
End of Account owner	</AcctOwnr>
End of ReservationIdentification	</Dflt>
End of choice	/xorCurRsvatnIdDfltRsvatnId
End of CurrentOrDefaultReservation	</RsvatnId>
NewReservationValueSet	<NewRsvatnValSet>
Start Date	<StartDtTm>
Date	<Dt></Dt>
End of Start Date	</StartDtTm>
Amount	<Amt>
Amount without currency	<AmtWthtCcy></AmtWthtCcy>
End of Amount	</Amt>
End of NewReservationValueSet	</NewRsvatnValSet>
End of messsge name for ModifyReservation	</ModifyRsvatn>

Attributes:

name of attribute	format	short description	description
<ModifyRsvatn>		Messsge name for ModifyReservation Mandatory	Messsge name for ModifyReservation Validation: [1..1]
<MsgHdr>		Message Header Mandatory	Set of characteristics specific to the message Validation: [1..1]
<MsgId></MsgId>	35x	Message Identification Mandatory	Message Identification String of characters that uniquely identifies a message at senders side. Validation: [1..1]
</MsgHdr>		End of Message Header Mandatory	Validation: [1..1]
<RsvatnId>		CurrentOrDefaultReservatio n Mandatory	CurrentOrDefaultReservation Validation: [1..1]
xorCurRsvatnIdDfltRsvatnId		choice Optional	choice amongst CurRsvatnId and DfltRsvatnId Validation:
<Cur>		CurrentReservationId Mandatory	CurrentReservationId <CurRsvatnId> and <DfltRsvatnId> are mutually exclusive. If <CurRsvatnId> is present, <DfltRsvatnId> must not be present, and viceversa. Validation: [1..1]
<Tp>		ReservationType Mandatory	ReservationType Validation: [1..1]
<Cd></Cd>		ReservationTypeCode Mandatory	ReservationTypeCode SSP restricted code list: UPAR = UrgentPaymentReservation Amount set aside by a participant to reserve liquidity from its own account, exclusively for executing urgent payments. HPAR = HighlyUrgentPayment reservation Amount set aside by a participant to reserve liquidity from its own account, exclusively for executing highly urgent payment Specifies the type of limit. The only possible value is: "CARE" (Reservation for Cash Withdrawals). Validation: [1..1]
</Tp>		End of ReservationType Mandatory	End of ReservationType Validation: [1..1]

name of attribute	format	short description	description
<AcctOwnr>		Account Owner Optional	Validation: [0..1]
<FinInstnId>		Financial Institution Identification Mandatory	Validation: [1..1]
<BICFI>-</BICFI>	4!a2!a2!c3!c	BICFIIdentifier Optional	BICFIIdentifier Specifies the participant to which the reservation is referred. The attribute is mandatory when the requestor is the co-manager or the NCB of the participant. Validation: [0..1]
</FinInstnId>		End of Financial Institution Identification Mandatory	Validation: [1..1]
</AcctOwnr>		End of Account owner Optional	Validation: [0..1]
</Cur>		End of CurrentReservationId Mandatory	Validation: [1..1]
<Dflt>		ReservationIdentification Mandatory	<DfltRsvatnId> and <CurRsvatnId> are mutually exclusive. If <DfltRsvatnId> is present, <CurRsvatnId> must not be present, and viceversa. Validation: [1..1]
<Tp>		ReservationType Mandatory	Validation: [1..1]
<Cd>-</Cd>		ReservationTypeCode Mandatory	ReservationTypeCode SSP restricted code list: UPAR = UrgentPaymentReservation Amount set aside by a participant to reserve liquidity from its own account, exclusively for executing urgent payments. HPAR = HighlyUrgentPayment reservation Amount set aside by a participant to reserve liquidity from its own account, exclusively for executing highly urgent payment Specifies the type of limit. Possible values: "CARE" (Reservation for Cash Withdrawals) and "THRE " (Threshold for Advise of Investment). Validation: [1..1]
</Tp>		End of ReservationType Mandatory	Validation: [1..1]
<AcctOwnr>		Account Owner	

name of attribute	format	short description	description
		Optional	Validation: [0..1]
<FinInstnId>		Financial Institution Identification Mandatory	Financial Institution Identification Validation: [1..1]
<BICFI>-</BICFI>	4!a2!a2!c3!c	BICFIIdentifier Optional	BICFIIdentifier Specifies the participant to which the reservation is referred. The attribute is mandatory when the requestor is the co-manager or the NCB of the participant. Validation: [0..1]
</FinInstnId>		End of Financial Institution Identification Mandatory	End of Financial Institution Identification Validation: [1..1]
</AcctOwnr>		End of Account owner Optional	Validation: [0..1]
</Dflt>		End of ReservationIdentification Mandatory	Validation: [1..1]
/xorCurRsvatnIdDfltRsvatnId		End of choice Optional	end of choice amongst CurRsvatnId or DfltRsvatnId Validation:
</RsvatnId>		End of CurrentOrDefaultReservation Mandatory	End of CurrentOrDefaultReservation Validation: [1..1]
<NewRsvatnValSet>		NewReservationValueSet Mandatory	NewReservationValueSet Validation: [1..1]
<StartDtTm>		Start Date Optional	Start Date Validation: [0..1]
<Dt>-</Dt>	ISODate	Date Mandatory	Date within a particular calendar year represented by YYYY-MM-DD (ISO 8601). Date at which the reservation becomes effective. The attribute is mandatory when the request is for modification of a current reservation Validation: [1..1]
</StartDtTm>		End of Start Date Optional	End of Start Date Validation: [0..1]
<Amt>		Amount Mandatory	Validation:

name of attribute	format	short description	description
			[1..1]
<AmtWthtCcy>- </AmtWthtCcy>	14n	Amount without currency Mandatory	Amount . Validation: [1..1]
</Amt>		End of Amount Mandatory	Validation: [1..1]
</NewRsvatnValSet>		End of NewReservationValueSet Mandatory	End of NewReservationValueSet Validation: [1..1]
</ModifyRsvatn>		End of messsge name for ModifyReservation Mandatory	End of messsge name for ModifyReservation Validation: [1..1]

Error Codes:

Order	Error code				Error Text / Validation/ Remark
	SSP	Y-copy	V-shape	XML	
1	X41			1401	Error Text: No permission. RBAC User role(s) are not sufficient. Validation: RBAC role name "APPLICATE", "APPLICSTE" or "APPLICBTE" are required Remark: checked by ICM / Receipt
2	866	C6	AC06	2866	Error Text: Exclusion of participant Validation: Remark:
3	862	C2	TM01	2862	Error Text: Request out of cut-off time Validation: Remark:
4	861	C1	RF01	2861	Error Text: Double input Validation: Remark:
5	852	B2	XI12	2852	Error Text: Invalid character or invalid numeric value Validation: Remark:
6	H14			H014	Error Text: Requested country code missing in input Validation: Remark:
7	H12			H012	Error Text: Requested BIC missing in input Validation: Remark:
8	H11			H011	Error Text: Requested BIC unknown Validation: Remark:
9	H08			H008	Error Text: Requestor unknown Validation: Remark:
10	H07	M7		H007	Error Text: Account not open Validation: Remark:
11	H04	M4	XT16	H004	Error Text: Operation not allowed (e.g. cross border) Validation: Remark:
12	H01		XI01	H001	Error Text: Sender not allowed Validation: Remark:

Order	Error code				Error Text / Validation/ Remark
	SSP	Y-copy	V-shape	XML	

ModifyReservation_HAM_1

Scope: Request of modification of current reservation for cash withdrawals. The requestor is the account owner.

Messsge name for ModifyReservation	<ModfyRsvatn>
Message Header	<MsgHdr>
Message Identification	<MsgId>HACDEFGHIJKLMNOPQRST123456789012345</MsgId>
End of Message Header	</MsgHdr>
CurrentOrDefaultReservation	<RsvatnId>
CurrentReservationId	<Cur>
ReservationType	<Tp>
ReservationTypeCode	<Cd>CARE</Cd>
End of ReservationType	</Tp>
End of CurrentReservationId	</Cur>
End of CurrentOrDefaultReservation	</RsvatnId>
NewReservationValueSet	<NewRsvatnValSet>
Start Date	<StartDtTm>
Date	<Dt>2008-09-11</Dt>
End of Start Date	</StartDtTm>
Amount	<Amt>
Amount without currency	<AmtWthtCcy>1234.56</AmtWthtCcy>
End of Amount	</Amt>
End of NewReservationValueSet	</NewRsvatnValSet>
End of messsge name for ModifyReservation	</ModfyRsvatn>

ModifyReservation_HAM_2

Scope: Request of modification of threshold for advice of investment. The requestor is the NCB of the account owner.

Messsge name for ModifyReservation	<ModfyRsvatn>
Message Header	<MsgHdr>
Message Identification	<MsgId>HACDEFGHIJKLMNOPQRST123456789012345</MsgId>
End of Message Header	</MsgHdr>
CurrentOrDefaultReservation	<RsvatnId>
ReservationIdentification	<Dflt>
ReservationType	<Tp>
ReservationTypeCode	<Cd>THRE</Cd>
End of ReservationType	</Tp>
Account Owner	<AcctOwnr>
Financial Institution Identification	<FinInstnId>
BICFIIdentifier	<BICFI>BBBBJPJNXXX</BICFI>
End of Financial Institution Identification	</FinInstnId>
End of Account owner	</AcctOwnr>
End of ReservationIdentification	</Dflt>
End of CurrentOrDefaultReservation	</RsvatnId>
NewReservationValueSet	<NewRsvatnValSet>
Amount	<Amt>
Amount without currency	<AmtWthtCcy>1234.56</AmtWthtCcy>
End of Amount	</Amt>
End of NewReservationValueSet	</NewRsvatnValSet>
End of messsge name for ModifyReservation	</ModfyRsvatn>

6.7.9 ModifyStandingOrder

Cash Management Standard

ModifyStandingOrder_HAM

Scope: The Modify Standing Order Message is used by account holders in HAM (or by NCBs on behalf of the account holder) to modify the standing order for automatic liquidity transfers at start of day from HAM to RTGS account. This message will be replied by a Receipt Message. Non repudiation of emission (NRE) is supported.

<camt.024.001.xx>

Structure:

Message Type	<ModifyStgOrdr>
Message Header	<MsgHdr>
Message Identification	<MsgId></MsgId>
End of Message Header	</MsgHdr>
Standing Order Indicator	<StgOrdrId>
Account Identification	<Acct>
Identification	<Id>
GenericAccountIdentification	<Othr>
AccountIdentification	<Id></Id>
End of GenericAccountIdentification	</Othr>
End Identification	</Id>
End of Account	</Acct>
End of Standing order Id	</StgOrdrId>
New Standing Order Value Set	<NewStgOrdrValSet>
Amount	<Amt>
Amount without currency	<AmtWthtCcy></AmtWthtCcy>
End of Amount	</Amt>
Frequency	<Frqcy></Frqcy>
End of Standing order details	</NewStgOrdrValSet>
End of Messagename for ModifyStandingOrder	</ModifyStgOrdr>

Attributes:

name of attribute	format	short description	description
<ModfyStgOrdr>		Message Type Mandatory	Validation: [1..1]
<MsgHdr>		Message Header Mandatory	Set of characteristics specific to the message Validation: [1..1]
<MsgId>-</MsgId>	35x	Message Identification Mandatory	Message Identification String of characters that uniquely identifies a message at senders side. Validation: [1..1]
</MsgHdr>		End of Message Header Mandatory	Validation: [1..1]
<StgOrdrId>		Standing Order Indicator Mandatory	Validation: [1..1]
<Acct>		Account Identification Mandatory	Validation: [1..1]
<Id>		Identification Mandatory	Validation: [1..1]
<Othr>		GenericAccountIdentification Mandatory	GenericAccountIdentification Validation: [1..1]
<Id>-</Id>	BICFI	AccountIdentification Mandatory	AccountIdentification BIC of the participant to whom the standing order is referred. It must be valorised even in case it is the same BIC of the sender of the message. Validation: [1..1]
</Othr>		End of GenericAccountIdentification Mandatory	End of GenericAccountIdentification Validation: [1..1]
</Id>		End Identification Mandatory	End Identification Validation: [1..1]
</Acct>		End of Account Mandatory	Validation: [1..1]
</StgOrdrId>		End of Standing order Id Mandatory	Validation:

name of attribute	format	short description	description
			[1..1]
<NewStgOrdrValSet>		New Standing Order Value Set Mandatory	Validation: [1..1]
<Amt>		Amount Mandatory	Validation: [1..1]
<AmtWthtCcy>- </AmtWthtCcy>	14n	Amount without currency Mandatory	Amount . If the value is >=999999999999.00the amount of the transfer will be the whole balance of the account. If the value is <999999999999.00the amount of the transfer will be the specified value, if available (nothing if not available). Validation: [1..1]
</Amt>		End of Amount Mandatory	Validation: [1..1]
<Frqcy>-</Frqcy>	4x	Frequency Mandatory	It must be "DAIL". Validation: [1..1]
</NewStgOrdrValSet>		End of Standing order details Mandatory	Validation: [1..1]
</ModifyStgOrdr>		End of Messagename for ModifyStandingOrder Mandatory	Validation: [1..1]

Error Codes:

Order	Error code				Error Text / Validation/ Remark
	SSP	Y-copy	V-shape	XML	
1	X41			1401	Error Text: No permission. RBAC User role(s) are not sufficient. Validation: RBAC role name "APPLICATE", "APPLICSTE" or "APPLICBTE" are required Remark: checked by ICM / Receipt
2	866	C6	AC06	2866	Error Text: Exclusion of participant Validation: Remark:
3	861	C1	RF01	2861	Error Text: Double input Validation: Remark:
4	852	B2	XI12	2852	Error Text: Invalid character or invalid numeric value Validation: Remark:
5	H12			H012	Error Text: Requested BIC missing in input Validation: Remark:
6	H11			H011	Error Text: Requested BIC unknown Validation: Remark:
7	H08			H008	Error Text: Requestor unknown Validation: Remark:
8	H07	M7		H007	Error Text: Account not open Validation: Remark:
9	H04	M4	XT16	H004	Error Text: Operation not allowed (e.g. cross border) Validation: Remark:
10	H01		XI01	H001	Error Text: Sender not allowed Validation: Remark:

ModifyStandingOrder_HAM_1

Scope: Request for modification of the standing order for liquidity transfers from HAM to RTGS account. The requestor is the account owner.

Message Type	<ModfyStgOrdr>
Message Header	<MsgHdr>
Message Identification	<MsgId>HACDEFGHIJKLMNOPQRST123456789012345</MsgId>
End of Message Header	</MsgHdr>
Standing Order Indicator	<StgOrdrId>
Account Identification	<Acct>
Identification	<Id>
GenericAccountIdentification	<Othr>
AccountIdentification	<Id>BBBBITRRXXX</Id>
End of GenericAccountIdentification	</Othr>
End Identification	</Id>
End of Account	</Acct>
End of Standing order Id	</StgOrdrId>
New Standing Order Value Set	<NewStgOrdrValSet>
Amount	<Amt>
Amount without currency	<AmtWthtCcy>1234.56</AmtWthtCcy>
End of Amount	</Amt>
Frequency	<Frqcy>DAIL</Frqcy>
End of Standing order details	</NewStgOrdrValSet>
End of Messagename for ModifyStandingOrder	</ModfyStgOrdr>

ModifyStandingOrder_HAM_2

Scope: Request for modification of the standing order for liquidity transfers from HAM to RTGS account: the amount of the standing order is set equal to the whole balance of the HAM account. The requestor is the NCB of the account owner.

Message Type	<ModfyStgOrdr>
Message Header	<MsgHdr>
Message Identification	<MsgId>HACDEFGHIJKLMNOPQRST123456789012345</MsgId>
End of Message Header	</MsgHdr>
Standing Order Indicator	<StgOrdrId>
Account Identification	<Acct>
Identification	<Id>
GenericAccountIdentification	<Othr>
AccountIdentification	<Id>TTTTITRRXX</Id>
End of GenericAccountIdentification	</Othr>
End Identification	</Id>
End of Account	</Acct>
End of Standing order Id	</StgOrdrId>
New Standing Order Value Set	<NewStgOrdrValSet>
Amount	<Amt>
Amount without currency	<AmtWthtCcy> 99999999999.00</AmtWthtCcy>
End of Amount	</Amt>
Frequency	<Frqcy>DAIL</Frqcy>
End of Standing order details	</NewStgOrdrValSet>
End of Messagename for ModifyStandingOrder	</ModfyStgOrdr>

6. 7.10 ModifyTransaction (for CBs only)

Cash Management Standard

ModifyTransaction_HAM

Scope: The Modify Transaction Message is used by NCBs to change (on behalf of the account holder) the order of transactions pending in the queue. This message will be replied by a Receipt Message. Non repudiation of emission (NRE) is supported.

<camt.007.001.xx>

Structure:

Message name for ModifyTransaction	<ModifyTx>
Message Header	<MsgHdr>
Message Identification	<MsgId></MsgId>
End of Message Header	</MsgHdr>
Modification	<Mod>
PaymentIdentification	<PmtId>
Choice	xorShrtBizIdPrtryId
Short Business Identification	<ShrtBizId>
TransactionIdentification	<TxId></TxId>
Value date	<IntrBkSttlmDt></IntrBkSttlmDt>
Instructing Agent	<InstgAgt>
Financial Institution Identification	<FinInstnId>
BICFIIdentifier	<BICFI></BICFI>
End of Financial Institution Identification	</FinInstnId>
Instructing Agent	<InstgAgt>
End ShortBusinessIdentification	</ShrtBizId>
ProprietaryId	<PrtryId></PrtryId>
End of choice	/xorShrtBizIdPrtryId
EndPaymentIdentification	</PmtId>
New Payment Value Set	<NewPmtValSet>
Priority	<Prty>
Proprietary Code	<PrtryCd></PrtryCd>
End Priority	</Prty>
End of NewPaymentValueSet	</NewPmtValSet>
End of Modification	</Mod>
End of Message name for ModifyTransaction	</ModifyTx>

Attributes:

name of attribute	format	short description	description
<ModifyTx>		Message name for ModifyTransaction Mandatory	Message name for ModifyTransaction Validation: [1..1]
<MsgHdr>		Message Header Mandatory	Set of characteristics specific to the message Validation: [1..1]
<MsgId>-</MsgId>	35x	Message Identification Mandatory	Message Identification String of characters that uniquely identifies a message at senders side. Validation: [1..1]
</MsgHdr>		End of Message Header Mandatory	Validation: [1..1]
<Mod>		Modification Mandatory	This element contains both the InstructionReference and the NewPaymentValueSet, used for the modification of the transaction. Validation: ****[1..1] differs from the cash management standard. SSP currently supports only one payment modification per request.
<PmtId>		PaymentIdentification Mandatory	Set of elements to provide further means of referencing a payment transaction Validation: [1..1]
xorShrtBizIdPrtryId		Choice Mandatory	Choice amongst ShrtBizId or PrtryRef Validation: [1..1]
<ShrtBizId>		Short Business Identification Mandatory	Validation: [1..1]
<TxId>-</TxId>	35x	TransactionIdentification Mandatory	Unique and unambiguous identification of a payment transaction, as assigned by the originator. The payment transaction reference is used for reconciliation or to link tasks relating to the payment transaction. TRN of the original payment instruction. If present, all <PmtInstrRef>, <IntrBkValDt> and <InstgAgtd> must be present (HAM business identifier). If present, <PrtryRef> (Internal transfer Identifier) is not allowed. Validation: [1..1]
<IntrBkSttlmDt>-</IntrBkSttlmDt>	ISODate	Value date Mandatory	Value date Settlement date (yyyy-mm-dd). If present, all <PmtInstrRef>, <IntrBkValDt> and <InstgAgtd> must be present (HAM business identifier). If present, <PrtryRef> (Internal transfer Identifier) is not allowed. Validation: [1..1]
<InstgAgt>		Instructing Agent	Instructing Agent

name of attribute	format	short description	description
		Mandatory	Validation: [1..1]
<FinInstnId>		Financial Institution Identification Mandatory	Financial Institution Identification Validation: [1..1]
<BICFI>-</BICFI>	4!a2!a2!c3!c	BICFIIdentifier Mandatory	BICFIIdentifier BIC of the instructing agent (sender of the transaction instruction). If present, all <PmtInstrRef>, <IntrBkValDt> and <InstgAgtId> must be present (HAM business identifier). If present, <PrtryRef> (Internal transfer Identifier) is not allowed. Validation: [1..1]
</FinInstnId>		End of Financial Institution Identification Mandatory	End of Financial Institution Identification Validation: [1..1]
<InstgAgt>		Instructing Agent Mandatory	Instructing Agent Validation: [1..1]
</ShrtBizId>		End ShortBusinessIdentification Mandatory	Validation: [1..1]
<PrtryId>-</PrtryId>	43x	ProprietaryId Mandatory	ProprietaryId Internal transfer identifier. Unique and unambiguous identifier of a transaction, generated by HAM. If present, <PmtInstrRef>, <IntrBkValDt> and <InstgAgtId> (HAM business identifier) are not allowed. Validation: [1..1]
/xorShrtBizIdPrtryId		End of choice Mandatory	Validation: [1..1]
</PmtId>		EndPaymentIdentification Mandatory	End of Set of elements to reference a payment transaction Validation: [1..1]
<NewPmtValSet>		New Payment Value Set Mandatory	Validation: [1..1]
<Prty>		Priority Mandatory	Validation: [1..1]
<PrtryCd>-</PrtryCd>	4x	Proprietary Code Mandatory	It can be: "INCR" (increase order in the queue) or "DECR" (decrease order in the queue). Validation: [1..1]

name of attribute	format	short description	description
</Prty>		End Priority	
		Mandatory	Validation: [1..1]
</NewPmtValSet>		End of NewPaymentValueSet	
		Mandatory	Validation: [1..1]
</Mod>		End of Modification	
		Mandatory	Validation: ****[1..1] differs from the cash management standard
</ModifyTx>		End of Messagename for ModifyTransaction	
		Mandatory	Validation: [1..1]

Error Codes:

Order	Error code				Error Text / Validation/ Remark
	SSP	Y-copy	V-shape	XML	
1	X41			1401	Error Text: No permission. RBAC User role(s) are not sufficient. Validation: RBAC role name "APPLICBTE" is required Remark: checked by ICM / Receipt
2	X44			1404	Error Text: If "non repudiation of emission" is mandatory, the NRE indicator flag has to be present Validation: If non-repudiaton processing is mandatory, the tag <SwInt:NRIndicator>TRUE</SwInt:NRIndicator> has to be present. Remark: Receipt /checked by ICM
3	868	C8	XI19	2868	Error Text: Invalid sending/receiving BIC Validation: Remark:
4	866	C6	AC06	2866	Error Text: Exclusion of participant Validation: Remark:
5	861	C1	RF01	2861	Error Text: Double input Validation: Remark:
6	H10	M1		H010	Error Text: Data not found (request data does not exist) Validation: Remark:
7	H08			H008	Error Text: Requestor unknown Validation: Remark:
8	H01		XI01	H001	Error Text: Sender not allowed Validation: Remark:

ModifyTransaction_HAM_1

Scope: Request of increasing the order in the queue of a transaction identified through an Internal Transfer Identifier.

MessageName for ModifyTransaction	<ModifyTx>
Message Header	<MsgHdr>
Message Identification	<MsgId>HACDEFGHIL1234567890ABCDEFGHI12345</MsgId>
End of Message Header	</MsgHdr>
Modification	<Mod>
PaymentIdentification	<PmtId>
ProprietaryId	<PrtryRef>ABCDEFGHI1234567890ABCDEFGHI1234567890ABC</PrtryRef>
EndPaymentIdentification	</PmtId>
New Payment Value Set	<NewPmtValSet>
Priority	<Prty>
Proprietary Code	<PrtryCd>INCR</PrtryCd>
End Priority	</Prty>
End of NewPaymentValueSet	</NewPmtValSet>
End of Modification	</Mod>
End of MessageName for ModifyTransaction	</ModifyTx>

ModifyTransaction_HAM_2

Scope: Request of increasing the order in the queue of a transaction identified through a HAM Business Identifier.

MessageName for ModifyTransaction	<ModfyTx>
Message Header	<MsgHdr>
Message Identification	<MsgId>HACDEFGHIL1234567890ABCDEFGHIL12345</MsgId>
End of Message Header	</MsgHdr>
Modification	<Mod>
PaymentIdentification	<PmtId>
Short Business Identification	<ShrtBizId>
TransactionIdentification	<TxId>ABCDEFGHIL123456</TxId>
Value date	<IntrBkSttlmDt>2008-09-12</IntrBkSttlmDt>
Instructing Agent	<InstgAgt>
Financial Institution Identification	<FinInstnId>
BICFIIdentifier	<BICFI>BBBITRRXXX</BICFI>
End of Financial Institution Identification	</FinInstnId>
Instructing Agent	<InstgAgt>
End ShortBusinessIdentification	</ShrtBizId>
EndPaymentIdentification	</PmtId>
New Payment Value Set	<NewPmtValSet>
Priority	<Prty>
Proprietary Code	<PrtryCd>INCR</PrtryCd>
End Priority	</Prty>
End of NewPaymentValueSet	</NewPmtValSet>
End of Modification	</Mod>
End of MessageName for ModifyTransaction	</ModfyTx>

6. 7.11 ReleasePayment (for CBs only)

SSP Proprietary Messages

ReleasePayment_HAM

Scope: The ReleasePayment message is sent to agree or disagree on a payment when its processing has been stopped due to exclusion. The request is sent by the responsible CB of an excluded HAM participant or in case of transactions instructed by an excluded HAM co-manager, the message has to be sent by the responsible CB of the co-managed HAM account holder.

The ReleasePayment message is replied by a Receipt message.

To identify the payment to be released it can be used the Short Business Identification or the internal transfer identifier (Proprietary Reference) from HAM.

Non-Repudiation of Emission (NRE) is required.

<camt.998.001.xx>

Structure:

Name Proprietary message	<PrtryMsg>
Message Header	<MsgHdr>
Message Identification	<MsgId></MsgId>
End of Message Header	</MsgHdr>
Proprietary Data	<PrtryData>
Proprietary Data type	<Tp>ReleasePayment</Tp>
Proprietary Data	<Data>
SSP Proprietary Data	<SspPrtryDt>
InstructionReference	<InstrRef>
Choice	xorShrtBizIdPrtryRef
Short Business Identification	<ShrtBizId>
PaymentInstructionRef	<PmtInstrRef></PmtInstrRef>
InterbankValueDate	<IntrBkValDt></IntrBkValDt>
Instructing Agent Identification	<InstgAgtId></InstgAgtId>
End ShortBusinessIdentification	</ShrtBizId>
Proprietary Reference	<PrtryRef></PrtryRef>
End of choice	/xorShrtBizIdPrtryRef
End of InstructionReference	</InstrRef>
New Payment Value Set	<NewPmtValSet>
ProprietaryCode	<PrtryCd></PrtryCd>
End of NewPaymentValueSet	</NewPmtValSet>
End of SSP Proprietary Data	</SspPrtryDt>
End of Proprietary Data	</Data>
End of Proprietary Data	</PrtryData>
End proprietary message	</PrtryMsg>

Attributes:

name of attribute	format	short description	description
<PrtryMsg>		Name Proprietary message Mandatory A2A	Validation:
<MsgHdr>		Message Header Mandatory A2A	Set of characteristics specific to the message Message Reference Validation: [1..1]
<MsgId>-</MsgId>	35x	Message Identification Mandatory A2A	Message Identification String of characters that uniquely identifies a message at senders side. Validation: [1..1]
</MsgHdr>		End of Message Header Mandatory A2A	Validation: [1..1]
<PrtryData>		Proprietary Data Mandatory A2A	Proprietary Data Validation: [1..1]
<Tp>-</Tp>		Proprietary Data type Mandatory A2A	Proprietary Data type Validation: [1..1]
<Data>		Proprietary Data Mandatory	Proprietary data content Validation: [1..1]
<SspPrtryDt>		SSP Proprietary Data Mandatory A2A	SSP Proprietary Data Validation: [1..1]
<InstrRef>		InstructionReference Mandatory A2A	PaymentIdentificationChoice Reference to the instruction related to the payment for which information is requested. A choice between ways of identifying a payment instruction by its references and business identification. PaymentInstructionReference [1..1] QueueIdentification [1..1] ShortBusinessIdentification [1..1] LongBusinessIdentification [1..1] Validation: [1..1]
xorShrtBizIdPrtryRef		Choice Mandatory A2A	Choice amongst ShrtBizId or PrtryRef Validation: [1..1]
<ShrtBizId>		Short Business Identification	

name of attribute	format	short description	description
		Mandatory A2A	Validation: [1..1]
<PmtInstrRef>-</PmtInstrRef>	16x	PaymentInstructionRef	Unique and unambiguous identifier for a payment instruction, as assigned by the clearing agent or the initiating party. TRN of the original payment instruction. If present, all <PmtInstrRef>, <IntrBkValDt> and <InstgAgtd> must be present (HAM business identifier). If present, <PrtryRef> (Internal transfer Identifier) is not allowed.
		Mandatory A2A	Validation: [1..1]
<IntrBkValDt>-</IntrBkValDt>		InterbankValueDate	InterbankValueDate Settlement date (yyyy-mm-dd). If present, all <PmtInstrRef>, <IntrBkValDt> and <InstgAgtd> must be present (HAM business identifier). If present, <PrtryRef> (Internal transfer Identifier) is not allowed.
		Mandatory A2A	Validation: [1..1]
<InstgAgtd>-</InstgAgtd>	11x	Instructing Agent Identification	BIC of the instructing agent (sender of the transaction instruction). If present, all <PmtInstrRef>, <IntrBkValDt> and <InstgAgtd> must be present (HAM business identifier). If present, <PrtryRef> (Internal transfer Identifier) is not allowed.
		Mandatory A2A	Validation: [1..1]
</ShrtBizId>		End ShortBusinessIdentification	
		Mandatory A2A	Validation: [1..1]
<PrtryRef>-</PrtryRef>	43x	Proprietary Reference	Internal transfer identifier. Unique and unambiguous identifier of a transaction, generated by HAM. If present, <PmtInstrRef>, <IntrBkValDt> and <InstgAgtd> (HAM business identifier) are not allowed.
		Mandatory A2A	Validation: [1..1]
/xorShrtBizIdPrtryRef		End of choice	
		Mandatory A2A	Validation: [1..1]
</InstrRef>		End of InstructionReference	
		Mandatory A2A	Validation: [1..1]
<NewPmtValSet>		New Payment Value Set	
		Mandatory A2A	Validation: [1..1] Specifies if the payment is agreed or disagreed for further processing. AGRE = Agree; DISA = Disagree
<PrtryCd>-</PrtryCd>	4x	ProprietaryCode	
		Mandatory A2A	Validation: [1..1] Agree or Disagree are only possible, if the status of payment is "Accounting Stopped due to exclusion" and the value date is the current business day.
</NewPmtValSet>		End of NewPaymentValueSet	

name of attribute	format	short description	description
		Mandatory	Validation:
		A2A	[1..1]
</SspPrtryDt>		End of SSP Proprietary Data	End of Root element for all SSP proprietary data
		Mandatory	Validation:
		A2A	[1..1]
</Data>		End of Proprietary Data	
		Mandatory	Validation:
			[1..1]
</PrtryData>		End of Proprietary Data	End of Proprietary Data
		Mandatory	Validation:
		A2A	[1..1]
</PrtryMsg>		End proprietary message	
		Mandatory	Validation:
		A2A	

Error Codes:

Order	Error code				Error Text / Validation/ Remark
	SSP	Y-copy	V-shape	XML	
1	X41			1401	Error Text: No permission. RBAC User role(s) are not sufficient. Validation: RBAC role name "APPLICBTE" is required Remark: checked by ICM / Receipt
2	X44			1404	Error Text: If "non repudiation of emission" is mandatory, the NRE indicator flag has to be present Validation: If non-repudiaton processing is mandatory, the tag <SwInt:NRIndicator>TRUE</SwInt:NRIndicator> has to be present. Remark: Receipt /checked by ICM
3	868	C8	XI19	2868	Error Text: Invalid sending/receiving BIC Validation: Remark:
4	861	C1	RF01	2861	Error Text: Double input Validation: Remark:
5	852	B2	XI12	2852	Error Text: Invalid character or invalid numeric value Validation: Remark:
6	H10	M1		H010	Error Text: Data not found (request data does not exist) Validation: Remark:
7	H08			H008	Error Text: Requestor unknown Validation: Remark:
8	H01		XI01	H001	Error Text: Sender not allowed Validation: Remark:

ReleasePayment_HAM_1

Scope: Agreement for a transaction identified through an internal transfer identifier.

Name Proprietary message	<PrtryMsg>
Message Header	<MsgHdr>
Message Identification	<MsgId>HACDEFGHIJKLMNOPQRST123456789012345</MsgId>
End of Message Header	</MsgHdr>
Proprietary Data	<PrtryData>
Proprietary Data type	<Tp>ReleasePayment</Tp>
Proprietary Data	<Data>
SSP Proprietary Data	<SspPrtryDt>
InstructionReference	<InstrRef>
Proprietary Reference	<PrtryRef>ABCD43</PrtryRef>
End of InstructionReference	</InstrRef>
New Payment Value Set	<NewPmtValSet>
ProprietaryCode	<PrtryCd>AGRE</PrtryCd>
End of NewPaymentValueSet	</NewPmtValSet>
End of SSP Proprietary Data	</SspPrtryDt>
End of Proprietary Data	</Data>
End of Proprietary Data	</PrtryData>
End proprietary message	</PrtryMsg>

ReleasePayment_HAM_2

Scope: Disagreement for a transaction identified through an external transfer identifier (HAM Business Identifier).

Name Proprietary message	<PrtryMsg>
Message Header	<MsgHdr>
Message Identification	<MsgId>HACDEFGHIJKLMNOPQRST123456789012345</MsgId>
End of Message Header	</MsgHdr>
Proprietary Data	<PrtryData>
Proprietary Data type	<Tp>ReleasePayment</Tp>
Proprietary Data	<Data>
SSP Proprietary Data	<SspPrtryDt>
InstructionReference	<InstrRef>
Short Business Identification	<ShrtBizId>
PaymentInstructionRef	<PmtInstrRef>ABCDEFGHIL123456</PmtInstrRef>
InterbankValueDate	<IntrBkValDt>2008-09-12</IntrBkValDt>
Instructing Agent Identification	<InstgAgtId>BBBBITRRXXX</InstgAgtId>
End ShortBusinessIdentification	</ShrtBizId>
End of InstructionReference	</InstrRef>
New Payment Value Set	<NewPmtValSet>
ProprietaryCode	<PrtryCd>DISA</PrtryCd>
End of NewPaymentValueSet	</NewPmtValSet>
End of SSP Proprietary Data	</SspPrtryDt>
End of Proprietary Data	</Data>
End of Proprietary Data	</PrtryData>
End proprietary message	</PrtryMsg>

6. 7.12 ReportOnInterests (for CBs only)

SSP Proprietary Messages

ReportOnInterests _HAM

Scope: The Report On Interests File is used to send to NCBs, in push mode (FileAct), information about the amount of interests calculated.

<camt.998.001.xx>

Structure:

Name Proprietary message	<PrtryMsg>
Message Identification	<Msgld>
Reference	<Ref></Ref>
End Message Identification	</Msgld>
Proprietary Data	<PrtryDt>
Type	<Tp>ReportOnInterests</Tp>
SSP Proprietary Data	<SspPrtryDt>
Country Code	<Ctry></Ctry>
SettlementDate	<RptValDt></RptValDt>
Number of Items	<NbOfItms></NbOfItms>
Total Number of Items	<TotNbOfItms></TotNbOfItms>
Interest report	<IntrstRpt>
Account Identification Debit	<DbtAcct>
BIC	<BIC></BIC>
End of Account Identification Debit	</DbtAcct>
Account Identification Credit	<CdtAcct>
BIC	<BIC></BIC>
End of Account Identification Credit	</CdtAcct>
SettlementDate	<PrcgVldtyDt></PrcgVldtyDt>
Amount	<Amt>
Amount without currency	<AmtWthtCcy></AmtWthtCcy>
End of Amount	</Amt>
End Interest report	</IntrstRpt>
End of SSP Proprietary Data	</SspPrtryDt>
End of Proprietary Data	</PrtryDt>
End proprietary message	</PrtryMsg>

Attributes:

name of attribute	format	short description	description
<PrtryMsg>		Name Proprietary message Mandatory	Validation: [1..1]
<Msgld>		Message Identification Mandatory	Message business identification Unique and unambiguous identifier for a message, as assigned by the Sender. This unique identifier can be used for cross-referencing purposes in subsequent messages. Validation: [1..1]
<Ref>-</Ref>	35x	Reference Mandatory	Unique and unambiguous reference String of characters that uniquely identifies a message at senders side. Validation: [1..1]
</Msgld>		End Message Identification Mandatory	Validation: [1..1]
<PrtryDt>		Proprietary Data Mandatory	Proprietary Data Validation: [1..1]
<Tp>-</Tp>	35x	Type Mandatory	Identifies the type of message. It will be: "ReportOnInterests". Validation: [1..1]
<SspPrtryDt>		SSP Proprietary Data Mandatory	SSP Proprietary Data Validation: [1..1]
<Ctry>-</Ctry>	2!a	Country Code Mandatory	Country Code Country Code Validation: [1..1]
<RptValDt>-</RptValDt>	Date	SettlementDate Mandatory	Report Validity date (date of creation of the report) (yyyy-mm-dd). Validation: [1..1]
<NbOfItms>-</NbOfItms>	18n	Number of Items Mandatory	Progressive number of the file (each report can be composed of more than one file) (18.0). Validation: [1..1]
<TotNbOfItms>-</TotNbOfItms>	18n	Total Number of Items Mandatory	Total number of files which form a single report (18.0). Validation: [1..1]
<IntrstRpt>		Interest report Mandatory	Validation:

name of attribute	format	short description	description
			[1..n]
<DbtAcct>		Account Identification Debit Mandatory	Validation: [1..1]
<BIC>-</BIC>	11x	BIC Mandatory	BIC identifier of the account to be debited. Validation: [1..1]
</DbtAcct>		End of Account Identification Debit Mandatory	Validation: [1..1]
<CdtAcct>		Account Identification Credit Mandatory	Validation: [1..1]
<BIC>-</BIC>	11x	BIC Mandatory	BIC identifier of the account to be credited. Validation: [1..1]
</CdtAcct>		End of Account Identification Credit Mandatory	Validation: [1..1]
<PrcgVldtyDt>-</PrcgVldtyDt>	Date	SettlementDate Mandatory	Interests settlement date (yyyy-mm-dd). Validation: [1..1]
<Amt>		Amount Mandatory	Validation: [1..1]
<AmtWthtCcy>-</AmtWthtCcy>	18n	Amount without currency Mandatory	Amount to be credited/debited . Validation: [1..1]
</Amt>		End of Amount Mandatory	Validation: [1..1]
</IntrstRpt>		End Interest report Mandatory	Validation: [1..n]
</SspPrtryDt>		End of SSP Proprietary Data Mandatory	End of SSP Proprietary Data Validation: [1..1]
</PrtryDt>		End of Proprietary Data Mandatory	Validation: [1..1]
</PrtryMsg>		End proprietary message	

name of attribute	format	short description	description
		Mandatory	Validation: [1..1]

Error Codes:

ReportOnInterests_HAM_1

Scope: Report on interests (last file of the report; whole report composed by 3 files).

Name Proprietary message	<PrtryMsg>
Message Identification	<Msgld>
Reference	<Ref>HACDEFGHIJKLMNOPQRST123456789012345</Ref>
End Message Identification	</Msgld>
Proprietary Data	<PrtryDt>
Type	<Tp>ReportOnInterests</Tp>
SSP Proprietary Data	<SspPrtryDt>
Country Code	<Ctry>DE</Ctry>
SettlementDate	<RptValDt>2007-06-30</RptValDt>
Number of Items	<NbOfItms>3</NbOfItms>
Total Number of Items	<TotNbOfItms>3</TotNbOfItms>
Interest report	<IntrstRpt>
Account Identification Debit	<DbtAcct>
BIC	<BIC>BITAITRRXX</BIC>
End of Account Identification Debit	</DbtAcct>
Account Identification Credit	<CdtAcct>
BIC	<BIC>AAAAITBBXX</BIC>
End of Account Identification Credit	</CdtAcct>
SettlementDate	<PrcgVldtyDt>2007-07-02</PrcgVldtyDt>
Amount	<Amt>
Amount without currency	<AmtWthtCcy>100.05</AmtWthtCcy>
End of Amount	</Amt>
End Interest report	</IntrstRpt>
Interest report	<IntrstRpt>
Account Identification Debit	<DbtAcct>
BIC	<BIC>BITAITRRXX</BIC>
End of Account Identification Debit	</DbtAcct>
Account Identification Credit	<CdtAcct>
BIC	<BIC>DDDDITBBXX</BIC>
End of Account Identification Credit	</CdtAcct>
SettlementDate	<PrcgVldtyDt>2007-07-02</PrcgVldtyDt>
Amount	<Amt>
Amount without currency	<AmtWthtCcy>500.01</AmtWthtCcy>
End of Amount	</Amt>
End Interest report	</IntrstRpt>
End of SSP Proprietary Data	</SspPrtryDt>
End of Proprietary Data	</PrtryDt>
End proprietary message	</PrtryMsg>

6. 7.13 ReturnAccount

Cash Management Standard

ReturnAccount_HAM

Scope: The Return Account Message is used to return information about the balance of an account in HAM ("HAM account" or "CB customer account"). The message is also used to return information about the value of the standing order for automatic liquidity transfers from HAM to RTGS account. The connected request is performed through a Get Account Message

<camt.004.001.xx>

Structure:

Message Type	<RtrAcct>
Message Header	<MsgHdr>
Message Identification	<MsgId></MsgId>
Original Business Query	<OrgnlBizQry>
Message Identification	<MsgId></MsgId>
End of Original Business Query	</OrgnlBizQry>
End of Message Header	</MsgHdr>
BusinessDayReportOrErrorChoice	<RptOrErr>
Choice	xorAcctRptOprlErr
AccountReport	<AcctRpt>
Account Identification	<AcctId>
GenericAccountIdentification	<Othr>
AccountIdentification	<Id></Id>
End of GenericAccountIdentification	</Othr>
End of Account Identification	</AcctId>
Account information (or business error)	<AcctOrErr>
Account Identification	<Acct>
CashAccountType	<Tp>
ExternalCashAccountTypeCode	<Cd></Cd>
End of CashAccountType	</Tp>
MultilateralBalance	<MulBal>
Amount	<Amt></Amt>
Credit or debit indicator	<CdtDbtInd></CdtDbtInd>
Balance Type choice	<Tp>
BalanceTypeCode	<Cd></Cd>
End balance type choice	</Tp>
Value Date	<ValDt>
Date Time	<DtTm></DtTm>
End Value Date	</ValDt>
End of MultilateralBalance	</MulBal>
Standing Order	<StgOrdr>
Amount	<Amt>
Amount without currency	AmtWthtCcy></AmtWthtCcy>
End of Amount	</Amt>
Credit or debit indicator	<CdtDbtInd></CdtDbtInd>
End of Standing Order	</StgOrdr>
End of Account	</Acct>
End of Account or Business Error	</AcctOrErr>
End of AccountReport	</AcctRpt>
Operational Error	<OprlErr>
Error handling	<Err>
Proprietary error code	<Prtry></Prtry>

End error handling				</Err>
Description				<Desc></Desc>
End of Operational Error				</OpriErr>
End of Choice				/xorAcctRptOpriErr
End of AccountOrOperationalErrorChoice				</RptOrErr>
End of Message Type				</RtrAcct>

Attributes:

name of attribute	format	short description	description
<RtrAcct>		Message Type Mandatory	Validation: [1..1]
<MsgHdr>		Message Header Mandatory	Set of characteristics specific to the message Validation: [1..1]
<MsgId>-</MsgId>	35x	Message Identification Mandatory	Message Identification String of characters that uniquely identifies a message at senders side. Validation: [1..1]
<OrgnlBizQry>		Original Business Query Mandatory	Original Business Query, reference to the query Validation: [1..1]
<MsgId>-</MsgId>	35x	Message Identification Mandatory	Message Identification Message identification of the connected request . Validation: [1..1]
</OrgnlBizQry>		End of Original Business Query Mandatory	End of Original Business Query, reference to the query Validation: [1..1]
</MsgHdr>		End of Message Header Mandatory	Validation: [1..1]
<RptOrErr>		BusinessDayReportOrError Choice Mandatory	Choice amongst BizRpt and OprlErr Validation: [1..1]
xorAcctRptOprlErr		Choice Mandatory	Choice between AccountReport and OperationalError Validation: [1..1]
<AcctRpt>		AccountReport Mandatory	Validation: [1..n]
<AcctId>		Account Identification Mandatory	Account Identification Validation: [1..1]
<Othr>		GenericAccountIdentification Mandatory	GenericAccountIdentification Validation: [1..1]
<Id>-</Id>	BICFI	AccountIdentification Mandatory	AccountIdentification BIC identifier of the participant to whom data provided are referred Validation:

name of attribute	format	short description	description
			[1..1]
</Othr>		End of GenericAccountIdentification Mandatory	End of GenericAccountIdentification Validation: [1..1]
</AcctId>		End of Account Identification Mandatory	Validation: [1..1]
<AcctOrErr>		Account information (or business error) Mandatory	Validation: [1..1]
<Acct>		Account Identification Mandatory	Validation: [1..1]
<Tp>		CashAccountType Optional	CashAccountType Validation: [0..1]
<Cd>-</Cd>		ExternalCashAccountType Code Mandatory	ExternalCashAccountTypeCode SSP restricted code list: CACC = Current Account used to post debits and credits when no specific account has been nominated SACC = Settlement Account used to post debit and credit entries, as a result of transactions cleared and settled through a specific clearing and settlement system. It will be: "CACC" (current account). Validation: [1..1]
</Tp>		End of CashAccountType Optional	End of CashAccountType Validation: [0..1]
<MulBal>		MultilateralBalance Optional	Validation: [0..n]
<Amt>-</Amt>	18d	Amount Mandatory	Amount . Validation: [1..1]
<CdtDbtInd>-</CdtDbtInd>	4!a	Credit or debit indicator Mandatory	Debit credit indicator. It will be: "CRDT" (credit) or "DBIT" (debit). Validation: [1..1]
<Tp>		Balance Type choice	Balance type. It can be: "OPNG" (opening balance) or "CRRT" (current balance). Special case: if the account is no more active, but a balance greater than zero is still present, it will be "CLSG" (closing balance).

name of attribute	format	short description	description
		Mandatory	Validation: [1..1]
<Cd>		BalanceTypeCode	<p>Specifies the nature of the balance, eg, opening balance.</p> <p>ADJT= Adjustment Average balance to be held in the settlement account at the end of each day in order to fulfil the reserve due. The approximation will be always made rounding up.</p> <p>AVLB = Available Balance of money or securities that is at the disposal of the account owner on the date specified.</p> <p>BLCK = Blocked Balance representing the regulatory reserve that a financial institution must have with the account servicing institution, eg, the minimum credit balance a financial institution is to keep with ist Central Bank for mandatory reserve purposes. In some countries, a blocked balance is known as a 'reserve' balance.</p> <p>BOOK = Book Balance that is registered in the books of the account servicer.</p> <p>CLSG = Closing Balance of the account at the end of the account servicer's business day. It is the sum of the opening balance at the beginning of the day and all entries booked to the account during the account servicer's business day.</p> <p>CRDT = Credit Balance representing the sum of all credit entries booked to an account.</p> <p>CRRT = Current Balance of the account at a precise moment in time.</p> <p>DBIT = Debit Balance representing the sum of all debit entries booked to an account.</p> <p>DLOD = DaylightOverdraft Balance representing the intra day overdraft granted by the Central Bank to financial institutions participating in a RTGS system. This balance may vary over time and shall be offset at the end of the day.</p> <p>EAST = EligibleAssets Balance representing the potential loan a Central Bank would make in cash if the collateral is pledged, eg, securities available and eligible as collateral with the Central Bank.</p> <p>INTM = Interim Balance calculated in the course of the account servicer's business day, at the time specified, and subject to further changes during the business day. The interim balance is calculated on the basis of booked credit and debit items during the calculation time/period specified.</p> <p>LRLD = LimitRelated Balance of a specific limit value, eg, a bilateral balance is calculated in relation to a given bilateral limit.</p> <p>LTSF= LiquidityTransfer Balance composed of the sum of all liquidity transfers made to or from an account.</p> <p>OPNG = Opening Book balance of the account at the beginning of the account servicer's business day. It always equals the closing book balance from the previous business day. Note: the available balance at the beginning of the account servicer's business day may be different from the closing book balance from the previous business day.</p>

name of attribute	format	short description	description
			<p>PDNG = Pending Balance of securities pending delivery, eg, orders to sell securities have been executed but settlement of the open transactions has not been confirmed.</p> <p>PRAV = ProgressiveAverage Average of the daily balances on the account used to fulfil the reserve requirements calculated from the beginning of the maintenance period.</p> <p>PYMT = Payment Balance representing the sum of entries as a result of payments processing. Entries relating to fees, interest, or other movements not a result of payments sent or received by the account owner are not included.</p> <p>XCRD = ExpectedCredit Balance, composed of booked entries and pending items known at the time of calculation, which projects the end of day credit balance if everything books to the account and no other credit entry is posted.</p> <p>XDBT = ExpectedDebit Balance, composed of booked entries and pending items known at the time of calculation, which projects the end of day debit balance if everything books to the account and no other debit entry is posted.</p> <p>XPCD = Expected Balance, composed of booked entries and pending items known at the time of calculation , which projects the end of day balance if everything is booked on the account and no other entry is posted.</p> <p>*****NOTE = Noted Balance Balance representing the amount that a financial institution has set aside for a specific reason and which is therefore not available</p> <p>Balance type. It can be: "OPNG" (opening balance) or "CRRT" (current balance). Special case: if the account is no more active, but a balance greater than zero is still present, it will be "CLSG " (closing balance).</p>
		Mandatory	Validation: [1..1]
</Tp>		End balance type choice	
		Mandatory	Validation: [1..1]
<ValDt>		Value Date	
		Optional	Validation: [0..1]
<DtTm></DtTm>	ISODateTime	Date Time	
		Mandatory	Date and time of response (with UTC shift) (yyyy-mm-ddThh-mm-ss+ii:nn). Validation: [1..1]
</ValDt>		End Value Date	
		Optional	Validation: [0..1]
</MulBal>		End of MultilateralBalance	
		Optional	Validation: [0..n]
<StgOrdr>		Standing Order	
		Optional	Validation:

name of attribute	format	short description	description
			[0..n]
<Amt>		Amount Mandatory	Validation: [1..1]
<AmtWthtCcy>- </AmtWthtCcy>	18n	Amount without currency Mandatory	Standing Order amount . If the value is >=99999999999.00the amount of the transfer will be the whole balance of the HAM account. If the value is <99999999999.00the amount of the transfer will be the specified value, if available (nothing if not available). Validation: [1..1]
</Amt>		End of Amount Mandatory	Validation: [1..1]
<CdtDbtInd>-</CdtDbtInd>	4!a	Credit or debit indicator Mandatory	Debit credit indicator. It will be: "CRDT" (credit). Validation: [1..1]
</StgOrd>		End of Standing Order Optional	Validation: [0..n]
</Acct>		End of Account Mandatory	Validation: [1..1]
</AcctOrErr>		End of Account or Business Error Mandatory	Validation: [1..1]
</AcctRpt>		End of AccountReport Mandatory	Validation: [1..n]
<OprlErr>		Operational Error Mandatory	Validation: [1..1]
<Err>		Error handling Mandatory	Validation: [1..1]
<Prtry>-</Prtry>	4x	Proprietary error code Mandatory	Specification of the error, in free format. Validation: [1..1]
</Err>		End error handling Mandatory	Validation: [1..1]
<Desc>-</Desc>	140x	Description Optional	Error description Validation: [0..1]

name of attribute	format	short description	description
</OpriErr>		End of Operational Error	End of Operational Error
		Mandatory	Validation: [1..1]
/xorAcctRptOpriErr		End of Choice	
		Mandatory	Validation: [1..1]
</RptOrErr>		End of AccountOrOperationalError Choice	
		Mandatory	Validation: [1..1]
</RtrAcct>		End of Message Type	
		Mandatory	Validation: [1..1]

Error Codes:

ReturnAccount_HAM_1

Scope: A response to a request of information about account balance (see example 1 Get Account).

Message Type	<RtrAcct>
Message Header	<MsgId>
Message Identification	<MsgId>AACDEFGHIJKLMNOPQRST123456789012345</MsgId>
Original Business Query	<OrgnlBizQry>
Message Identification	<MsgId>HACDEFGHIJKLMNOPQRST123456789012345</MsgId>
End of Original Business Query	</OrgnlBizQry>
End of Message Header	</MsgHdr>
BusinessDayReportOrErrorChoice	<RptOrErr>
AccountReport	<AcctRpt>
Account Identification	<AcctId>
GenericAccountIdentification	<Othr>
AccountIdentification	<Id>BBBBITRRXXX</Id>
End of GenericAccountIdentification	</Othr>
End of Account Identification	</AcctId>
Account information (or business error)	<AcctOrErr>
Account Identification	<Acct>
CashAccountType	<Tp>
ExternalCashAccountTypeCode	<Cd>CACC</Cd>
End of CashAccountType	</Tp>
MultilateralBalance	<MulBal>
Amount	<Amt>1234.56</Amt>
Credit or debit indicator	<CdtDbtInd>CRDT</CdtDbtInd>
Balance Type choice	<Tp>
BalanceTypeCode	<Cd>OPNG</Cd>
End balance type choice	</Tp>
Value Date	<ValDt>
Date Time	<DtTm>2008-09-12T15:29:00+01:00</DtTm>
End Value Date	</ValDt>
End of MultilateralBalance	</MulBal>
MultilateralBalance	<MulBal>
Amount	<Amt>1255.56</Amt>
Credit or debit indicator	<CdtDbtInd>CRDT</CdtDbtInd>
Balance Type choice	<Tp>
BalanceTypeCode	<Cd>CRRT</Cd>
End balance type choice	</Tp>
Value Date	<ValDt>
Date Time	<DtTm>2008-09-12T15:29:00+01:00</DtTm>
End Value Date	</ValDt>
End of MultilateralBalance	</MulBal>
End of Account	</Acct>
End of Account or Business Error	</AcctOrErr>
End of AccountReport	</AcctRpt>
End of AccountOrOperationalErrorChoice	</BizRpt>
End of Message Type	</RtrAcct>

ReturnAccount_HAM_2

Scope: A response to a request of information about account balance. Requestor is the co-manager of the account holder (see example 2 Get Account).

Message Type	<RtrAcct>
Message Header	<MsgHdr>
Message Identification	<mSGId>AACDEFGHIJKLMNOPQRST123456789012345</mSGId>
Original Business Query	<OrgnBizQry>
Message Identification	<MsgId>HACDEFGHIJKLMNOPQRST123456789012345</MsgId>
End of Original Business Query	</OrgnBizQry>
End of Message Header	</MsgHdr>
BusinessDayReportOrErrorChoice	<RptOrErr>
AccountReport	<AcctRpt>
Account Identification	<AcctId>
GenericAccountIdentification	<Othr>
AccountIdentification	<Id>BBBBITRRXXX</Id>
End of GenericAccountIdentification	</Othr>
End of Account Identification	</AcctId>
Account information (or business error)	<AcctOrErr>
Account Identification	<Acct>
CashAccountType	<Tp>
ExternalCashAccountTypeCode	<Cd>CACC</Cd>
End of CashAccountType	</Tp>
MultilateralBalance	<MulBal>
Amount	<Amt>1234.56</Amt>
Credit or debit indicator	<CdtDbtInd>CRDT</CdtDbtInd>
Balance Type choice	<Tp>
BalanceTypeCode	<Cd>OPNG</Cd>
End balance type choice	</Tp>
Value Date	<ValDt>
Date Time	<DtTm>2008-09-12T15:29:00+01:00</DtTm>
End Value Date	</ValDt>
End of MultilateralBalance	</MulBal>
MultilateralBalance	<MulBal>
Amount	<Amt>1255.56</Amt>
Credit or debit indicator	<CdtDbtInd>CRDT</CdtDbtInd>
Balance Type choice	<Tp>
BalanceTypeCode	<Cd>CRRT</Cd>
End balance type choice	</Tp>
Value Date	<ValDt>
Date Time	<DtTm>2008-09-12T15:29:00+01:00</DtTm>
End Value Date	</ValDt>
End of MultilateralBalance	</MulBal>
End of Account	</Acct>
End of Account or Business Error	</AcctOrErr>
End of AccountReport	</AcctRpt>
End of AccountOrOperationalErrorChoice	</BizRpt>
End of Message Type	</RtrAcct>

ReturnAccount_HAM_3

Scope: A response to a request of information about the value of the standing order for liquidity transfers from HAM to RTGS account (see example 3 Get Account).

Message Type	<RtrAcct>
Message Header	<MsgHdr>
Message Identification	<MsgId>HACDEFGHIJKLMNOPQRST123456789012345</MsgId>
Original Business Query	<OrgnBizQry>
Message Identification	<MsgId>ABCDEFGHIJKLMNQRST123456789012345</MsgId>
End of Original Business Query	</OrgnBizQry>
End of Message Header	</MsgHdr>
BusinessDayReportOrErrorChoice	<RptOrErr>
AccountReport	<AcctRpt>
Account Identification	<AcctId>
GenericAccountIdentification	<Othr>
AccountIdentification	<Id>BBBTRRXXX</Id>
End of GenericAccountIdentification	</Othr>
End of Account Identification	</AcctId>
Account information (or business error)	<AcctOrErr>
Account Identification	<Acct>
CashAccountType	<Tp>
ExternalCashAccountTypeCode	<Cd>CACC</Cd>
End of CashAccountType	</Tp>
Standing Order	<StgOrdr>
Amount	<Amt>
Amount without currency	AmtWthtCcy>1111.00</AmtWthtCcy>
End of Amount	</Amt>
Credit or debit indicator	<CdtDbtInd>CRDT</CdtDbtInd>
End of Standing Order	</StgOrdr>
End of Account	</Acct>
End of Account or Business Error	</AcctOrErr>
End of AccountReport	</AcctRpt>
End of AccountOrOperationalErrorChoice	</BizRpt>
End of Message Type	</RtrAcct>

6. 7.14 ReturnBusinessDayInformation

Cash Management Standard

ReturnBusinessDayInformation_HAM

Scope: The Return Business Day Information Message is used to return information about the status of the HAM system and the events planned during the HAM operational day. The connected request is performed through a Get Business Day Information Message

<camt.019.001.xx>

Structure:

Message name for ReturnBusinessDayInformation	<RtrBizDayInf>
Message Header	<MsgHdr>
Message Identification	<MsgId></MsgId>
Original Business Query	<OrgnlBizQry>
Message Identification	<MsgId></MsgId>
End of Original Business Query	</OrgnlBizQry>
End of Message Header	</MsgHdr>
BusinessDayReportOrErrorChoice	<RptOrErr>
Choice amongst	xorBizRptOprErr
BusinessReport	<BizRpt>
SystemIdentification	<SysId>
Country Code	<Ctry></Ctry>
End of SystemIdentification	</SysId>
BusinessDayReportOrErrorChoice	<BizDayOrErr>
Business Day Information	<BizDayInf>
System Status	<SysSts>
SystemStatus	<Sts>
SystemStatusCode	<Cd></Cd>
End of SystemStatus	</Sts>
Validity Time	<VldtyTm>
From Date Time	<FrDtTm></FrDtTm>
End Validity Time	</VldtyTm>
End System Status	</SysSts>
System Information Per Currency	<SysInfPerCcy>
CurrencyCode	<SysCcy></SysCcy>
Session Period	<SsnPrd>
From Time	<FrTm></FrTm>
DateTime	<ToTm></ToTm>
End SessionPeriod	</SsnPrd>
Event	<Evt>
BalanceTypeCode	<Tp>
Event Code	<Cd></Cd>
End of SystemEventTypeChoice	</Tp>
Scheduled event time	<SchldTm></SchldTm>
EffectiveTime	<FctvTm></FctvTm>
End of Event	</Evt>
End of SystemInformationPerCurrency	</SysInfPerCcy>
End Business Day Information	</BizDayInf>
End of BusinessDayReportOrErrorChoice	</BizDayOrErr>
End of BusinessReport	</BizRpt>
Operational Error	<OprErr>
Error handling	<Err>
Proprietary error code	<Prtry></Prtry>

End error handling	</Err>
Description	<Desc></Desc>
End of Operational Error	</OprlErr>
End of choice	/xorBizRptOprlErr
End of BusinessDayReportOrErrorChoice	</RptOrErr>
End Message Type	</RtrBizDayInf>

Attributes:

name of attribute	format	short description	description
<RtrBizDayInf>		Message name for ReturnBusinessDayInformation Mandatory	Validation: [1..1]
<MsgHdr>		Message Header Mandatory	Set of characteristics specific to the message Validation: [1..1]
<MsgId>-</MsgId>	35x	Message Identification Mandatory	Message Identification String of characters that uniquely identifies a message at senders side. Validation: [1..1]
<OrgnlBizQry>		Original Business Query Mandatory	Original Business Query, reference to the query Validation: [1..1]
<MsgId>-</MsgId>	35x	Message Identification Mandatory	Message Identification Message identification of the connected request . Validation: [1..1]
</OrgnlBizQry>		End of Original Business Query Mandatory	End of Original Business Query, reference to the query Validation: [1..1]
</MsgHdr>		End of Message Header Mandatory	Validation: [1..1]
<RptOrErr>		BusinessDayReportOrError Choice Mandatory	Validation: [1..1]
xorBizRptOprlErr		Choice amongst Optional	Choice amongst xorBizRptOprlErr (Type: xor) Choice amongst BizRpt and OprlErr Validation:
<BizRpt>		BusinessReport Mandatory	Validation: [1..n]
<SysId>		SystemIdentification Mandatory	Validation: [1..1]
<Ctry>-</Ctry>	2!a	Country Code Mandatory	Country Code It contains the country code of the country whom data are referred. Validation: [1..1]
</SysId>		End of SystemIdentification Mandatory	Validation:

name of attribute	format	short description	description
			[1..1]
<BizDayOrErr>		BusinessDayReportOrError Choice Mandatory	Validation: [1..n]
<BizDayInf>		Business Day Information Mandatory	Validation: [1..1]
<SysSts>		System Status Optional	Validation: [0..1]
<Sts>		SystemStatus Mandatory	Validation: [1..1]
<Cd>-</Cd>		SystemStatusCode Mandatory	Status of the system. It can be: "ACTV" (active) if start of day already occurred or end of day not yet occurred; "CLSD" (closed) if start of day not yet occurred or end of day already occurred. Validation: [1..1]
</Sts>		End of SystemStatus Mandatory	Validation: [1..1]
<VldtyTm>		Validity Time Optional	Validation: [0..1]
<FrDtTm>-</FrDtTm>	DateTime	From Date Time Mandatory	Current HAM date and time (with UTC shift) (yyyy-mm-ddThh:mm:ss+ii:nn). Validation: [1..1]
</VldtyTm>		End Validity Time Optional	Validation: [0..1]
</SysSts>		End System Status Optional	Validation: [0..1]
<SysInfPerCcy>		System Information Per Currency Optional	Validation: [0..n]
<SysCcy>-</SysCcy>	3x	CurrencyCode Mandatory	Currency Code (EUR). Validation: [1..1]
<SsnPrd>		Session Period Optional	Validation: [0..1]

name of attribute	format	short description	description
<FrTm>-</FrTm>	ISOTime	From Time Mandatory	Start time of the HAM System (with UTC shift) (hh:mm:ss+ii:nn). Validation: [1..1]
<ToTm>-</ToTm>	DateTime	DateTime Mandatory	End time of the HAM System (with UTC shift) (hh:mm:ss+ii:nn). Validation: [1..1]
</SsnPrd>		End SessionPeriod Optional	Validation: [0..1]
<Evt>		Event Mandatory	Validation: [5..5]
<Tp>		BalanceTypeCode Mandatory	Validation: [1..1]
<Cd>-</Cd>	4x	Event Code Mandatory	Event code. It can be: "STDY" (Start of Day); "CRCO" (Cash Reservation Cutoff); "CUSC" (Customer Cutoff); "IBKC" (Interbank Cutoff); "ESTF" (Standing Facilities Cutoff). Validation: [1..1]
</Tp>		End of SystemEventTypeChoice Mandatory	Validation: [1..1]
<SchlddTm>-</SchlddTm>	DateTime	Scheduled event time Mandatory	Scheduled event time (with UTC shift) (yyyy-mm-ddThh:mm:ss+ii:nn). Validation: [1..1]
<FctvTm>-</FctvTm>	ISODateTime	EffectiveTime Optional	Actual event time (with UTC shift) (yyyy-mm-ddThh:mm:ss+ii:nn). Not present if the event not yet occurred. Validation: [0..1]
</Evt>		End of Event Mandatory	Validation: [5..5]
</SysInfPerCcy>		End of SystemInformationPerCurrency Optional	Validation: [0..n]
</BizDayInf>		End Business Day Information Mandatory	Validation: [1..1]

name of attribute	format	short description	description
</BizDayOrErr>		End of BusinessDayReportOrError Choice Mandatory	Validation: [1..n]
</BizRpt>		End of BusinessReport Mandatory	Validation: [1..n]
<OprlErr>		Operational Error Mandatory	Validation: [1..1]
<Err>		Error handling Mandatory	Validation: [1..1]
<Prtry>-</Prtry>	4x	Proprietary error code Mandatory	Specification of the error, in free format. Validation: [1..1]
</Err>		End error handling Mandatory	Validation: [1..1]
<Desc>-</Desc>	140x	Description Optional	Error description Validation: [0..1]
</OprlErr>		End of Operational Error Mandatory	End of Operational Error Validation: [1..1]
/xorBizRptOprlErr		End of choice Mandatory	Validation: [1..1]
</RptOrErr>		End of BusinessDayReportOrError Choice Mandatory	Validation: [1..1]
</RtrBizDayInf>		End Message Type Mandatory	Validation: [1..1]

Error Codes:

ReturnBusinessDayInformation_HAM_1

Scope: Return information about the status of the HAM system and events during the HAM operational day (see GetBusinessDayInformation example 1).

MessageName fo ReturnBusinessDayInformation	<RtrBizDayInf>
Message Header	<MsgHdr>
Message Identification	<MsgId>AACDEFGHIJKLMNOPQRST123456789012345</MsgId>
Original Business Query	</MsgId>
Message Identification	<MsgId>HACDEFGHIJKLMNOPQRST123456789012345</MsgId>
End of Original Business Query	</OrgnlBizQry>
End of Message Header	</MsgHdr>
BusinessDayReportOrErrorChoice	<RptOrErr>
BusinessReport	<BizRpt>
SystemIdentification	<SysId>
Country Code	<Ctry>GR</Ctry>
End of SystemIdentification	</SysId>
Business Day Information	<BizDayInf>
System Status	<SysSts>
SystemStatus	<Sts>
SystemStatusCode	<Cd>ACTV</Cd>
End of SystemStatus	</Sts>
Validity Time	<VldtyTm>
From Date Time	<FrDtTm>2008-09-12T11:29:00+01:00</FrDtTm>
End Validity Time	</VldtyTm>
End System Status	</SysSts>
System Information Per Currency	<SysInfPerCcy>
CurrencyCode	<SysCcy>EUR</SysCcy>
Session Period	<SsnPrd>
From Time	<FrTm>05:00:00</FrTm>
DateTime	<ToTm>22:30:00</ToTm>
End SessionPeriod	</SsnPrd>
Event	<Evt>
BalanceTypeCode	<Tp>
Event Code	<Cd>STDY</Cd>
End of SystemEventTypeChoice	</Tp>
Scheduled event time	<SchlddTm>2008-09-12T07:00:00+01:00</SchlddTm>
EffectiveTime	<FctvTm>2008-09-12T07:00:05+01:00</FctvTm>
End of Event	</Evt>
Event	<Evt>
BalanceTypeCode	<Tp>
Event Code	<Cd>CRCO</Cd>
End of SystemEventTypeChoice	</Tp>
Scheduled event time	<SchlddTm>2008-09-12T12:00:00+01:00</SchlddTm>
End of Event	</Evt>
Event	<Evt>
BalanceTypeCode	<Tp>
Event Code	<Cd>CUSC</Cd>
End of SystemEventTypeChoice	</Tp>
Scheduled event time	<SchlddTm>2008-09-12T17:00:00+01:00</SchlddTm>
End of Event	</Evt>
Event	<Evt>
BalanceTypeCode	<Tp>
Event Code	<Cd>IBKC</Cd>

End of SystemEventTypeChoice										</Tp>
Scheduled event time										<SchlddTm>2008-09-12T18:00:00+01:00</SchlddTm>
End of Event										</Evt>
Event										<Evt>
BalanceTypeCode										<Tp>
Event Code										<Cd>ESTF</Cd>
End of SystemEventTypeChoice										</Tp>
Scheduled event time										<SchlddTm>2008-09-12T18:30:00+01:00</SchlddTm>
End of Event										</Evt>
End of SystemInformationPerCurrency										</SysInfPerCcy>
End Business Day Information										</BizDayInf>
End of BusinessDayReportOrErrorChoice										</BizDayInfRpt>
End of BusinessReport										</BizRpt>
End of BusinessDayReportOrErrorChoice										</RptOrErr>
End Message Type										</RtrBizDayInf>

6. 7.15 ReturnReservation

Cash Management Standard

ReturnReservation_HAM

Scope: The Return Reservation Message is used to return information about the reservation for cash withdrawals (current or default) or about the value of the threshold for advice of investment. The connected request is performed through a Get Reservation Message.

<camt.047.001.xx>

Structure:

Message name for ReturnReservation	<RtrRsvatn>
Message Header	<MsgHdr>
Message Identification	<MsgId></MsgId>
Original Business Query	<OrgnlBizQry>
Message Identification	<MsgId></MsgId>
End of Original Business Query	</OrgnlBizQry>
End of Message Header	</MsgHdr>
BusinessReportOrErrorChoice	<RptOrErr>
Choice	xorBizRptOprlErr
BusinessReport	<BizRpt>
CurrentReservation	<CurRsvatn>
Reservationidentification	<RsvatnId>
ReservationType	<Tp>
ReservationTypeCode	<Cd></Cd>
End of ReservationType	</Tp>
Account Owner	<AcctOwnr>
Financial Institution Identification	<FinInstnId>
BICFIIdentifier	<BICFI></BICFI>
End of Financial Institution Identification	</FinInstnId>
End of Account owner	</AcctOwnr>
End of Reservationidentification	</RsvatnId>
Reservation or Error choice	<RsvatnOrErr>
Reservation	<Rsvatn>
Amount	<Amt>
Amount without currency	<AmtWthtCcy></AmtWthtCcy>
End of Amount	</Amt>
Start Date	<StartDtTm>
Date	<Dt></Dt>
End of Start Date	</StartDtTm>
End of Reservation	</Rsvatn>
End of Reservation or Error choice	</RsvatnOrErr>
End of CurrentReservation	</CurRsvatn>
DefaultReservation	<DfltRsvatn>
Reservationidentification	<RsvatnId>
ReservationType	<Tp>
ReservationTypeCode	<Cd></Cd>
End of ReservationType	</Tp>
Account Owner	<AcctOwnr>
Financial Institution Identification	<FinInstnId>
BICFIIdentifier	<BICFI></BICFI>
End of Financial Institution Identification	</FinInstnId>
End of Account owner	</AcctOwnr>
End of Reservationidentification	</RsvatnId>

Reservation or Error choice	<RsvatnOrErr>
Reservation	</Rsvatn>
Amount	<Amt>
Amount without currency	<AmtWthtCcy></AmtWthtCcy>
End of Amount	</Amt>
End of Reservation	</Rsvatn>
End of Reservation or Error choice	</RsvatnOrErr>
End of DefaultReservation	</DfltRsvatn>
End of BusinessReport	</BizRpt>
Operational Error	<OprlErr>
Error handling	<Err>
Proprietary error code	<Prtry></Prtry>
End error handling	</Err>
Description	<Desc></Desc>
End of Operational Error	</OprlErr>
End of choice	/xorBizRptOprErr
End of BusinessReportOrErrorChoice	</RptOrErr>
End of message name for ReturnReservation	</RtrRsvatn>

Attributes:

name of attribute	format	short description	description
<RtrRsvatn>		Message name for ReturnReservation Mandatory	Message name for ReturnReservation Validation: [1..1]
<MsgHdr>		Message Header Mandatory	Set of characteristics specific to the message Validation: [1..1]
<MsgId>-</MsgId>	35x	Message Identification Mandatory	Message Identification String of characters that uniquely identifies a message at senders side. Validation: [1..1]
<OrgnlBizQry>		Original Business Query Mandatory	Original Business Query, reference to the query Validation: [1..1]
<MsgId>-</MsgId>	35x	Message Identification Mandatory	Message Identification Message identification of the connected request . Validation: [1..1]
</OrgnlBizQry>		End of Original Business Query Mandatory	End of Original Business Query, reference to the query Validation: [1..1]
</MsgHdr>		End of Message Header Mandatory	Validation: [1..1]
<RptOrErr>		BusinessReportOrErrorChoice Mandatory	Validation: [1..1]
xorBizRptOprlErr		Choice Mandatory	Choice amongst BizRpt and OprlErr Validation: [1..1]
<BizRpt>		BusinessReport Mandatory	Validation: [1..1]
<CurRsvatn>		CurrentReservation Optional	CurrentReservation When a current reservation is requested, the data provided are related to the current date and to all the future dates for which a current reservation exists. Validation: [0..n]
<RsvatnId>		Reservationidentification Mandatory	Reservationidentification Validation: [1..1]
<Tp>		ReservationType	ReservationType

name of attribute	format	short description	description
		Mandatory	Validation: [1..1]
<Cd></Cd>		ReservationTypeCode	ReservationTypeCode SSP restricted code list: UPAR = UrgentPaymentReservation Amount set aside by a participant to reserve liquidity from its own account, exclusively for executing urgent payments. HPAR = HighlyUrgentPayment reservation Amount set aside by a participant to reserve liquidity from its own account, exclusively for executing highly urgent payment Specifies the type of reservation. It will be: "CARE" (Reservation for Cash Withdrawals).
		Mandatory	Validation: [1..1]
</Tp>		End of ReservationType	End of ReservationType
		Mandatory	Validation: [1..1]
<AcctOwnr>		Account Owner	
		Optional	Validation: [0..1]
<FinInstnId>		Financial Institution Identification	Financial Institution Identification
		Mandatory	Validation: [1..1]
<BICFI></BICFI>	4!a2!a2!c3!c	BICFIIdentifier	BICFIIdentifier Specifies the participant to which the reservation is referred.
		Optional	Validation: [0..1]
</FinInstnId>		End of Financial Institution Identification	End of Financial Institution Identification
		Mandatory	Validation: [1..1]
</AcctOwnr>		End of Account owner	
		Optional	Validation: [0..1]
</RsvatnId>		End of Reservationidentification	end of Reservationidentification
		Mandatory	Validation: [1..1]
<RsvatnOrErr>		Reservation or Error choice	
		Mandatory	Validation: [1..1]
<Rsvatn>		Reservation	Reservation
		Mandatory	Validation: [1..1]
<Amt>		Amount	

name of attribute	format	short description	description
		Mandatory	Validation: [1..1]
<AmtWthtCcy>- </AmtWthtCcy>	18n	Amount without currency Mandatory	Reservation Amount . Validation: [1..1]
</Amt>		End of Amount Mandatory	Validation: [1..1]
<StartDtTm>		Start Date Optional	Start Date Validation: [0..1]
<Dt>-</Dt>	ISODate	Date Mandatory	Date within a particular calendar year represented by YYYY-MM-DD (ISO 8601). Date at which the reservation becomes effective (with UTC shift) (yyyy-mm-dd+ii:nn). Validation: [1..1]
</StartDtTm>		End of Start Date Optional	End of Start Date Validation: [0..1]
</Rsvatn>		End of Reservation Mandatory	end of Reservation Validation: [1..1]
</RsvatnOrErr>		End of Reservation or Error choice Mandatory	Validation: [1..1]
</CurRsvatn>		End of CurrentReservation Optional	end of CurrentReservation Validation: [0..n]
<DfltRsvatn>		DefaultReservation Optional	DefaultReservation Container for Default Reservation. Validation: [0..1]
<RsvatnId>		Reservationidentification Mandatory	Reservationidentification Validation: [1..1]
<Tp>		ReservationType Mandatory	ReservationType Validation: [1..1]
<Cd>-</Cd>		ReservationTypeCode	ReservationTypeCode SSP restricted code list: UPAR = UrgentPaymentReservation Amount set aside by a participant to reserve liquidity from its own account, exclusively for executing urgent

name of attribute	format	short description	description
			payments. HPAR = HighlyUrgentPayment reservation Amount set aside by a participant to reserve liquidity from its own account, exclusively for executing highly urgent payment Specifies the type of reservation. Possible values are: "CARE" (Reservation for Cash Withdrawals) and "THRE" (Threshold for Advise of Investment).
		Mandatory	Validation: [1..1]
</Tp>		End of ReservationType	End of ReservationType
		Mandatory	Validation: [1..1]
<AcctOwnr>		Account Owner	
		Optional	Validation: [0..1]
<FinInstnId>		Financial Institution Identification	Financial Institution Identification
		Mandatory	Validation: [1..1]
<BICFI>-</BICFI>	4!a2!a2!c3!c	BICFIIdentifier	BICFIIdentifier Specifies the participant to which the reservation is referred.
		Mandatory	Validation: [1..1]
</FinInstnId>		End of Financial Institution Identification	End of Financial Institution Identification
		Mandatory	Validation: [1..1]
</AcctOwnr>		End of Account owner	
		Optional	Validation: [0..1]
</RsvatnId>		End of Reservationidentification	end of Reservationidentification
		Mandatory	Validation: [1..1]
<RsvatnOrErr>		Reservation or Error choice	
		Mandatory	Validation: [1..1]
<Rsvatn>		Reservation	Reservation
		Mandatory	Validation: [1..1]
<Amt>		Amount	
		Mandatory	Validation: [1..1]
<AmtWthtCcy>-</AmtWthtCcy>	18n	Amount without currency	Reservation Amount .
		Mandatory	Validation: [1..1]

name of attribute	format	short description	description
</Amt>		End of Amount Mandatory	Validation: [1..1]
</Rsvatn>		End of Reservation Mandatory	end of Reservation Validation: [1..1]
</RsvatnOrErr>		End of Reservation or Error choice Mandatory	Validation: [1..1]
</DfltRsvatn>		End of DefaultReservation Optional	end of DefaultReservation Validation: [0..1]
</BizRpt>		End of BusinessReport Mandatory	Validation: [0..1]
<OprlErr>		Operational Error Mandatory	Validation: [1..1]
<Err>		Error handling Mandatory	Validation: [1..1]
<Prtry>-</Prtry>	4x	Proprietary error code Mandatory	Specification of the error, in free format. Validation: [1..1]
</Err>		End error handling Mandatory	Validation: [1..1]
<Desc>-</Desc>	140x	Description Optional	Error description Validation: [0..1]
</OprlErr>		End of Operational Error Mandatory	End of Operational Error Validation: [1..1]
/xorBizRptOprlErr		End of choice Mandatory	Validation: [1..1]
</RptOrErr>		End of BusinessReportOrErrorChoice Mandatory	Validation: [1..1]
</RtrRsvatn>		End of message name for ReturnReservation Mandatory	end of message name for ReturnReservation Validation:

name of attribute	format	short description	description
[1..1]			

Error Codes:

ReturnReservation_HAM_1

Scope: Return information about threshold for advice of investment (see Example 1 Get Reservation).

Message name for ReturnReservation	<RtrRsvatn>
Message Header	<MsgHdr>
Message Identification	<MsgId>HACDEFGHIJKLMNOPQRST123456789012345</MsgId>
Original Business Query	<OrgnlBizQry>
Message Identification	<MsgId>ABCDEFGHIJKLMNOPQRST123456789012345</MsgId>
End of Original Business Query	</OrgnlBizQry>
End of Message Header	</MsgHdr>
BusinessReportOrErrorChoice	<RptOrErr>
BusinessReport	<BizRpt>
DefaultReservation	<DfltRsvatn>
Reservationidentification	<RsvatnId>
ReservationType	<Tp>
ReservationTypeCode	<Cd>THRE</Cd>
End of ReservationType	</Tp>
Account Owner	<AcctOwnr>
Financial Institution Identification	<FinInstnId>
BICFIIdentifier	<BICFI>BBBBJPJNXXX</BICFI>
End of Financial Institution Identification	</FinInstnId>
End of Account owner	</AcctOwnr>
End of Reservationidentification	</RsvatnId>
Reservation or Error choice	<RsvatnOrErr>
Reservation	<Rsvatn>
Amount	<Amt>
Amount without currency	<AmtWthtCcy>1234.56</AmtWthtCcy>
End of Amount	</Amt>
End of Reservation	</Rsvatn>
End of Reservation or Error choice	</RsvatnOrErr>
End of DefaultReservation	</DfltRsvatn>
End of BusinessReport	</BizRpt>
End of BusinessReportOrErrorChoice	</RptOrErr>
End of message name for ReturnReservation	</RtrRsvatn>

ReturnReservation_HAM_2

Scope: Return information about current reservation for cash withdrawals (see Example 2 Get Reservation).

Message name for ReturnReservation	<RtrRsvatn>
Message Header	<MsgHdr>
Message Identification	<MsgId>HACDEFGHIJKLMNOPQRST123456789012345</MsgId>
Original Business Query	<OrgnlBizQry>
Message Identification	<MsgId>ABCDEFGHIJKLMNOPQRST123456789012345</MsgId>
End of Original Business Query	</OrgnlBizQry>
End of Message Header	</MsgHdr>
BusinessReportOrErrorChoice	<RptOrErr>
BusinessReport	<BizRpt>
CurrentReservation	<CurRsvatn>
Reservationidentification	<RsvatnId>
ReservationType	<Tp>
ReservationTypeCode	<Cd>CARE</Cd>
End of ReservationType	</Tp>
Account Owner	<AcctOwnr>
Financial Institution Identification	<FinInstnId>
BICFIIdentifier	<BICFI>BBBBITRRXXX</BICFI>
End of Financial Institution Identification	</FinInstnId>
End of Account owner	</AcctOwnr>
End of Reservationidentification	</RsvatnId>
Reservation or Error choice	<RsvatnOrErr>
Reservation	<Rsvatn>
Amount	<Amt>
Amount without currency	<AmtWthtCcy>1234.56</AmtWthtCcy>
End of Amount	</Amt>
Start Date	<StartDtTm>
Date	<Dt>2008-09-11+01:00</Dt>
End of Start Date	</StartDtTm>
End of Reservation	</Rsvatn>
End of Reservation or Error choice	</RsvatnOrErr>
End of CurrentReservation	</CurRsvatn>
End of BusinessReport	</BizRpt>
End of BusinessReportOrErrorChoice	</RptOrErr>
End of message name for ReturnReservation	</RtrRsvatn>

6. 7.16 ReturnThreshold (for CBs only)

SSP Proprietary Messages

ReturnThreshold_HAM

Scope: The Return Threshold Message is used to return information about the value of the threshold for advice of investment and the value of balance above the threshold for each "CB customer" of the requesting NCB. The connected request is performed by the NCB through a Get Threshold Message. The occurrences related to each CB customer are ordered by decreasing values of balance above the threshold.

<camt.998.001.xx>

Structure:

Name Proprietary message	<PrtryMsg>
Message Header	<MsgHdr>
Message Identification	<MsgId></MsgId>
End of Message Header	</MsgHdr>
Related	<Rltd>
Reference	<Ref></Ref>
End of Related	</Rltd>
Proprietary Data	<PrtryData>
Type	<Tp>ReturnThreshold</Tp>
Proprietary Data	<Data>
SSP Proprietary Data	<SspPrtryDt>
choice	xorBizRptOpriErr
BusinessReport	<BizRpt>
AccountReport	<AcctRpt>
Account Identification	<AcctId>
BIC	<BIC></BIC>
End of Account Identification	</AcctId>
Account Identification	<Acct>
Type	<Tp></Tp>
MultilateralBalance	<MulBal>
Amount	<Amt></Amt>
Credit or debit indicator	<CdtDbtInd></CdtDbtInd>
Type	<Tp></Tp>
Value Date	<ValDt>
Date Time	<DtTm></DtTm>
End Value Date	</ValDt>
End of MultilateralBalance	</MulBal>
End of Account	</Acct>
End of AccountReport	</AcctRpt>
Limit Report	<LmtRpt>
Liquidity Management Default Limit	<LqdyMgmtDfltLmt>
LimitIdentification	<LmtId>
Type	<Tp></Tp>
End of Limit Identification	</LmtId>
Limit	<Lmt>
Amount	<Amt>
Amount without currency	<AmtWthtCcy></AmtWthtCcy>
End of Amount	</Amt>
Credit or debit indicator	<CdtDbtInd></CdtDbtInd>
StartDateTime	<StartDtTm></StartDtTm>
End Limit	</Lmt>
End Liquidity Management Default Limit	</LqdyMgmtDfltLmt>

End of Limit Report	</LmtRpt>
End of BusinessReport	</BizRpt>
Operational Error	<OprlErr>
Error handling	<Err>
Proprietary error code	<Prtry></Prtry>
End error handling	</Err>
Description	<Desc></Desc>
End of Operational Error	</OprlErr>
End of choice	/xorBizRptOprlErr
End of SSP Proprietary Data	</SspPrtryDt>
End of Proprietary Data	</Data>
End of Proprietary Data	</PrtryData>
End proprietary message	</PrtryMsg>

Attributes:

name of attribute	format	short description	description
<PrtryMsg>		Name Proprietary message Mandatory	Validation: [1..1]
<MsgHdr>		Message Header Mandatory	Set of characteristics specific to the message Validation: [1..1]
<MsgId>-</MsgId>	35x	Message Identification Mandatory	Message Identification String of characters that uniquely identifies a message at senders side. Validation: [1..1]
</MsgHdr>		End of Message Header Mandatory	Validation: [1..1]
<Rltd>		Related Mandatory	References a previously received message. Validation: [1..1]
<Ref>-</Ref>	35x	Reference Mandatory	Unique and unambiguous reference Message identification of the connected request. Validation: [1..1]
</Rltd>		End of Related Mandatory	End of Related Validation: [1..1]
<PrtryData>		Proprietary Data Mandatory	Proprietary Data Validation: [1..1]
<Tp>-</Tp>	35x	Type Mandatory	Identifies the type of message. It will be: "ReturnThreshold". Validation: [1..1]
<Data>		Proprietary Data Mandatory	Proprietary data content Validation: [1..1]
<SspPrtryDt>		SSP Proprietary Data Mandatory	SSP Proprietary Data Validation: [1..1]
xorBizRptOprlErr		choice Mandatory	choice amongst BizRpt und OprlErr Rule description: If BusinessReport is present then OperationalError is not allowed. If BusinessReport is not present, then OperationalError is mandatory. Choice amongst BizRpt and OprlErr Validation: [1..1]

name of attribute	format	short description	description
<BizRpt>		BusinessReport	This sequence will be repeated "n" times, one for each CB customer of the requesting NCB.
		Mandatory	Validation: [1..n]
<AcctRpt>		AccountReport	
		Mandatory	Validation: [1..1]
<AcctId>		Account Identification	Account Identification
		Mandatory	Validation: [1..1]
<BIC>-</BIC>	11x	BIC	BIC identifier for the CB customer.
		Mandatory	Validation: [1..1]
</AcctId>		End of Account Identification	
		Mandatory	Validation: [1..1]
<Acct>		Account Identification	
		Mandatory	Validation: [1..1]
<Tp>-</Tp>	35x	Type	It will be: "CACC" (Current account).
		Mandatory	Validation: [1..1]
<MulBal>		MultilateralBalance	
		Mandatory	Validation: [1..n]
<Amt>-</Amt>	18d	Amount	Amount .
		Mandatory	Validation: [1..1]
<CdtDbtInd>-</CdtDbtInd>	4!a	Credit or debit indicator	Credit debit indicator. It can be: "CRDT" (credit) or "DBIT" (debit).
		Mandatory	Validation: [1..1]
<Tp>-</Tp>	35x	Type	Balance type code. It can be: "CRRT" (current balance) and "THRE" (balance above the threshold).
		Mandatory	Validation: [1..1]
<ValDt>		Value Date	
		Mandatory	Validation: [1..1]
<DtTm>-</DtTm>	ISODateTime	Date Time	Date and time of response (with UTC shift) (yyyy-mm-ddThh-mm-ss+ii:nn).
		Mandatory	Validation: [1..1]

name of attribute	format	short description	description
</ValDt>		End Value Date Mandatory	Validation: [1..1]
</MulBal>		End of MultilateralBalance Mandatory	Validation: [1..n]
</Acct>		End of Account Mandatory	Validation: [1..1]
</AcctRpt>		End of AccountReport Mandatory	Validation: [1..1]
<LmtRpt>		Limit Report Mandatory	Validation: [1..1]
<LqdyMgmtDfltLmt>		Liquidty Management Default Limit Mandatory	Validation: [1..1]
<LmtId>		LimitIdentification Mandatory	Validation: [1..1]
<Tp>-</Tp>	35x	Type Mandatory	Limit type code. It will be: "THRE" (threshold for advice of investment). Validation: [1..1]
</LmtId>		End of Limit Identification Mandatory	Validation: [1..1]
<Lmt>		Limit Mandatory	Validation: [1..1]
<Amt>		Amount Mandatory	Validation: [1..1]
<AmtWthtCcy>- </AmtWthtCcy>	18n	Amount without currency Mandatory	Amount . Validation: [1..1]
</Amt>		End of Amount Mandatory	Validation: [1..1]
<CdtDbtInd>-</CdtDbtInd>	4!a	Credit or debit indicator Mandatory	Credit debit code: It will be: "CRDT" (credit). Validation: [1..1]

name of attribute	format	short description	description
<StartDtTm>-</StartDtTm>		StartDateTime Mandatory	Date and time of response (with UTC shift) (yyyy-mm-ddThh-mm-ss+ii:nn). Validation: [1..1]
</Lmt>		End Limit Mandatory	Validation: [1..1]
</LqdyMgmtDfltLmt>		End Liquidity Management Default Limit Mandatory	Validation: [1..1]
</LmtRpt>		End of Limit Report Mandatory	Validation: [1..1]
</BizRpt>		End of BusinessReport Mandatory	Validation: [1..n]
<OprlErr>		Operational Error Mandatory	Validation: [1..1]
<Err>		Error handling Mandatory	Validation: [1..1]
<Prtry>-</Prtry>	4x	Proprietary error code Mandatory	Specification of the error, in free format. Validation: [1..1]
</Err>		End error handling Mandatory	Validation: [1..1]
<Desc>-</Desc>	140x	Description Optional	Specification of the error, in free format. Validation: [0..1]
</OprlErr>		End of Operational Error Mandatory	End of Operational Error Validation: [1..1]
/xorBizRptOprlErr		End of choice Mandatory	Validation: [1..1]
</SspPrtryDt>		End of SSP Proprietary Data Mandatory	End of SSP Proprietary Data Validation: [1..1]
</Data>		End of Proprietary Data Mandatory	Validation:

name of attribute	format	short description	description
			[1..1]
</PrtryData>		End of Proprietary Data Mandatory	End of Proprietary Data Validation: [1..1]
</PrtryMsg>		End proprietary message Mandatory	Validation: [1..1]

Error Codes:

ReturnThreshold_HAM_1

Scope: Response to request of information about the threshold for advice of investment of CB customers and about the value of balance above the threshold (see GetThreshold example 1)

Name Proprietary message	<PrtryMsg>
Message Header	<MsgHdr>
Message Identification	<MsgId>ABC123</MsgId>
End of Message Header	</MsgHdr>
Related	<Rltd>
Reference	<Ref>HACDEFGHIJKLMNOPQRST123456789012345</Ref>
End of Related	</Rltd>
Proprietary Data	<PrtryData>
Type	<Tp>ReturnThreshold</Tp>
Proprietary Data	<Data>
SSP Proprietary Data	<SspPrtryDt>
BusinessReport	<BizRpt>
AccountReport	<AcctRpt>
Account Identification	<AcctId>
BIC	<BIC>BBBBINBBXXX</BIC>
End of Account Identification	</AcctId>
Account Identification	<Acct>
Type	<Tp>CACC</Tp>
MultilateralBalance	<MulBal>
Amount	<Amt>200.00</Amt>
Credit or debit indicator	<CdtDbtInd>CRDT</CdtDbtInd>
Type	<Tp>CRRT</Tp>
Value Date	<ValDt>
Date Time	<DtTm>2008-09-11T09:30:47+01:00</DtTm>
End Value Date	</ValDt>
End of MultilateralBalance	</MulBal>
MultilateralBalance	<MulBal>
Amount	<Amt>150.00</Amt>
Credit or debit indicator	<CdtDbtInd>CRDT</CdtDbtInd>
Type	<Tp>THRE</Tp>
Value Date	<ValDt>
Date Time	<DtTm>2008-09-11T09:30:47+01:00</DtTm>
End Value Date	</ValDt>
End of MultilateralBalance	</MulBal>
End of Account	</Acct>
End of AccountReport	</AcctRpt>
Limit Report	<LmtRpt>
Liquidity Management Default Limit	<LqdyMgmtDfltLmt>
LimitIdentification	<LmtId>
Type	<Tp>THRE</Tp>
End of Limit Identification	</LmtId>
Limit	<Lmt>
Amount	<Amt>
Amount without currency	<AmtWthtCcy>50.00</AmtWthtCcy>
End of Amount	</Amt>
Credit or debit indicator	<CdtDbtInd>CRDT</CdtDbtInd>
StartDateTime	<StartDtTm>2008-09-11T09:30:47+01:00</StartDtTm>
End Limit	</Lmt>
End Liquidity Management Default Limit	</LqdyMgmtDfltLmt>

End of Limit Report	</LmtRpt>
End of BusinessReport	</BizRpt>
End of Proprietary Data	</Data>
BusinessReport	<BizRpt>
AccountReport	<AcctRpt>
Account Identification	<AcctId>
BIC	<BIC>DDDDJPJT987</BIC>
End of Account Identification	</AcctId>
Account Identification	<Acct>
Type	<Tp>CACC</Tp>
MultilateralBalance	<MulBal>
Amount	<Amt>33.55</Amt>
Credit or debit indicator	<CdtDbtInd>CRDT</CdtDbtInd>
Type	<Tp>CRRT</Tp>
Value Date	<ValDt>
Date Time	<DtTm>2008-09-11T09:30:47+01:00</DtTm>
End Value Date	</ValDt>
End of MultilateralBalance	</MulBal>
MultilateralBalance	<MulBal>
Amount	<Amt>66.45</Amt>
Credit or debit indicator	<CdtDbtInd>DBIT</CdtDbtInd>
Type	<Tp>THRE</Tp>
Value Date	<ValDt>
Date Time	<DtTm>2008-09-11T09:30:47+01:00</DtTm>
End Value Date	</ValDt>
End of MultilateralBalance	</MulBal>
End of Account	</Acct>
End of AccountReport	</AcctRpt>
Limit Report	<LmtRpt>
Liquidity Management Default Limit	<LqdyMgmtDfltLmt>
LimitIdentification	<LmtId>
Type	<Tp>THRE</Tp>
End of Limit Identification	</LmtId>
Limit	<Lmt>
Amount	<Amt>
Amount without currency	<AmtWthtCcy>100.00</AmtWthtCcy>
End of Amount	</Amt>
Credit or debit indicator	<CdtDbtInd>CRDT</CdtDbtInd>
StartDateTime	<StartDtTm>2008-09-11T09:30:47+01:00</StartDtTm>
End Limit	</Lmt>
End Liquidity Management Default Limit	</LqdyMgmtDfltLmt>
End of Limit Report	</LmtRpt>
End of BusinessReport	</BizRpt>
End of SSP Proprietary Data	</SspPrtryDt>
End of Proprietary Data	</PrtryData>
End proprietary message	</PrtryMsg>

6. 7.17 ReturnTransaction

Cash Management Standard

ReturnTransaction _HAM

Scope: The Return Transaction Message is used to return information about transactions.

The connected request is performed through a Get Transaction Message. If the query type "CHNG", "MODF" or "DELD" is used in the GetTransaction message, only modified, deleted or new items between two similar queries of information about incoming and/or outgoing payments of a HAM participant will be returned.

<camt.006.001.xx>

Structure:

Message name for Return Transaction	<RtrTx>
Message Header	<MsgHdr>
Message Identification	<MsgId></MsgId>
Original Business Query	<OrgnlBizQry>
Message Identification	<MsgId></MsgId>
End of Original Business Query	</OrgnlBizQry>
QueryName	<QryNm></QryNm>
End of Message Header	</MsgHdr>
BusinessReportOrErrorChoice	<RptOrErr>
Choice	xorBizRptOprlErr
BusinessReport	<BizRpt>
TransactionReport	<TxRpt>
PaymentIdentification	<PmtId>
ProprietaryId	<PrtryId></PrtryId>
EndPaymentIdentification	</PmtId>
TransactionOrErrorChoice	<TxOrErr>
Transaction	<Tx>
PaymentTo	<PmtTo>
Member Identification	<Mmbld>
Financial Institution Identification	<FinInstnId>
BICFIIdentifier	<BICFI></BICFI>
End of Financial Institution Identification	</FinInstnId>
End Member Identification	</Mmbld>
End PaymentTo	</PmtTo>
Payment From	<PmtFr>
Member Identification	<Mmbld>
Financial Institution Identification	<FinInstnId>
BICFIIdentifier	<BICFI></BICFI>
End of Financial Institution Identification	</FinInstnId>
End Member Identification	</Mmbld>
End Payment From	</PmtFr>
Credit or debit indicator	<CdtDbtInd></CdtDbtInd>
Payment	<Pmt>
RequestedExecutionDate	<ReqdExctnDt>
Date Time	<DtTm></DtTm>
End of RequestedExecutionDate	</ReqdExctnDt>
PaymentStatus	<Sts>
PaymentStatusCode	<Cd>
Choice	xorPdgStsFnlSts
Pending	<Pdg></Pdg>
Final	<Fnl></Fnl>
End of choice	/xorPdgStsFnlSts

End of Creditor	</Cdtr>
End of Parties	</Pties>
End Payment	</Pmt>
End ofTransaction	</Tx>
End of TransactionOrErrorChoice	</TxOrErr>
End Transaction Report	</TxRpt>
End of BusinessReport	</BizRpt>
Operational Error	<OprlErr>
Error handling	<Err>
Proprietary error code	<Prtry></Prtry>
End error handling	</Err>
Description	<Desc></Desc>
End of Operational Error	</OprlErr>
End of choice	/xorBizRptOprErr
End of BusinessReportOrErrorChoice	</RptOrErr>
End messagename ReturnTransaction	</RtrTx>

Attributes:

name of attribute	format	short description	description
<RtrTx>		Message name for Return Transaction Mandatory	Message name for Return Transaction Validation: [1..1]
<MsgHdr>		Message Header Mandatory	Set of characteristics specific to the message Validation: [1..1]
<MsgId>-</MsgId>	35x	Message Identification Mandatory	Message Identification String of characters that uniquely identifies a message at senders side. Validation: [1..1]
<OrgnlBizQry>		Original Business Query Mandatory	Original Business Query, reference to the query Validation: [1..1]
<MsgId>-</MsgId>	35x	Message Identification Mandatory	Message Identification Validation: [1..1]
</OrgnlBizQry>		End of Original Business Query Mandatory	End of Original Business Query, reference to the query Message identification of the connected request . Validation: [1..1]
<QryNm>	35x	QueryName Optional	Recalls the criteria (search and return criteria) defined in a preceding query. Identifier of a preceding message. The cross-reference is used for the creation of delta sets Reference for the delta set retrieval. Value is generated by ICM. Validation: [0..1]
</MsgHdr>		End of Message Header Mandatory	Validation: [1..1]
<RptOrErr>		BusinessReportOrErrorChoice Mandatory	Validation: [1..1]
xorBizRptOprlErr		Choice Mandatory	Choice amongst BizRpt e OprlErr Validation: [1..1]
<BizRpt>		BusinessReport Mandatory	Validation: [1..1]
<TxRpt>		TransactionReport Mandatory	Validation: [1..n]

name of attribute	format	short description	description
<PmtId>		PaymentIdentification	Set of elements to provide further means of referencing a payment transaction
		Mandatory	Validation: [1..1]
<PrtryId>-</PrtryId>	43x	ProprietaryId	ProprietaryId Internal transfer identifier. Unique and unambiguous identifier of a transaction, generated by HAM. Digits from 10 to 20 of the internal transfer identifier identify the BIC of the sender of the transaction .
		Mandatory	Validation: [1..1]
</PmtId>		EndPaymentIdentification	End of Set of elements to reference a payment transaction
		Mandatory	Validation: [1..1]
<TxOrErr>		TransactionOrErrorChoice	
		Mandatory	Validation: [1..1]
<Tx>		Transaction	
		Mandatory	Validation: [1..1]
<PmtTo>		PaymentTo	
		Optional	Validation: [0..1]
<Mmbld>		Member Identification	
		Optional	Validation: [0..1]
<FinInstnId>		Financial Institution Identification	Financial Institution Identification
		Mandatory	Validation: [1..1]
<BICFI>-</BICFI>	4!a2!a2!c3!c	BICFIIdentifier	BICFIIdentifier BIC of the creditor.
		Mandatory	Validation: [1..1]
</FinInstnId>		End of Financial Institution Identification	End of Financial Institution Identification
		Mandatory	Validation: [1..1]
</Mmbld>		End Member Identification	
		Optional	Validation: [0..1]
</PmtTo>		End PaymentTo	
		Optional	Validation: [0..1]
<PmtFr>		Payment From	
		Optional	Validation: [0..1]

name of attribute	format	short description	description
<MmblId>		Member Identification Optional	Validation: [0..1]
<FinInstnId>		Financial Institution Identification Mandatory	Financial Institution Identification Validation: [1..1]
<BICFI>-</BICFI>	4!a2!a2!c3!c	BICFIIdentifier Mandatory	BICFIIdentifier BIC of the debtor. Validation: [1..1]
</FinInstnId>		End of Financial Institution Identification Mandatory	End of Financial Institution Identification Validation: [1..1]
</MmblId>		End Member Identification Optional	Validation: [0..1]
</PmtFr>		End Payment From Optional	Validation: [0..1]
<CdtDbtInd>-</CdtDbtInd>	4!a	Credit or debit indicator Optional	Credit debit indicator. It will be: "CRDT" (credit) or "DBIT" (debit). Validation: [0..1]
<Pmt>		Payment Optional	Validation: [0..1]
<ReqdExctnDt>		RequestedExecutionDate Optional	Validation: [0..1]
<DtTm>-</DtTm>	ISODateTime	Date Time Mandatory	Specifies when the transaction arrived in HAM (yyyy-mm-ddThh:mm:ss+ii:nn). Validation: [1..1]
</ReqdExctnDt>		End of RequestedExecutionDate Optional	Validation: [0..1]
<Sts>		PaymentStatus Optional	Validation: [0..1]
<Cd>		PaymentStatusCode Optional	Validation: [0..1]
xorPdgStsFnlSts		Choice	Choice amongst PdgSts or FnlSts

name of attribute	format	short description	description
		Mandatory	Validation: [1..1]
<Pdg>-</Pdg>	4!c	Pending	Pending Status Code of the payment Specifies the (pending) status of the selected transaction. Possible values are: "PSTL" (pending settlement) for queued transactions or "STLE" (earmarked) for transactions delivered in advance. The attributes <PdgSts> and <FnlSts> are mutually exclusive. If <FnlSts> is valorised, <PdgSts> will not be valorised, and viceversa..
		Mandatory	Validation: [1..1]
<Fnl>-</Fnl>	4!c	Final	Final Status Code of the payment Specifies the (final) status of the selected transaction. Possible values are: "CAND" (cancelled) for cancelled transactions; "RJTD" (rejected) for transactions rejected by the clearing agent; "STLD" (settled) for transactions successfully processed. The attributes <FnlSts> and <PdgSts> are mutually exclusive. If <FnlSts> is valorised, <PdgSts> will not be valorised, and viceversa.
		Mandatory	Validation: [1..1]
/xorPdgStsFnlSts		End of choice	
		Mandatory	Validation: [1..1]
</Cd>		End of PaymentStatusCode	
		Optional	Validation: [0..1]
<DtTm>		DateTime	A specified date and time.
		Optional	Validation: [0..1]
<DtTm>-</DtTm>	ISODateTime	Date Time	Date and Time at which the transaction assumed its status (with UTC shift) (yyyy-mm-ddThh:mm:ss+ii:nn).
		Mandatory	Validation: [1..1]
</DtTm>		End of DateTime	
		Optional	Validation: [0..1]
<Rsn>		Reason	
		Optional	Validation: [0..1]
<PrtryRjctn>		ProprietaryStatusJustification	
		Mandatory	Validation: [1..1]
<PrtryStsRsn>-</PrtryStsRsn>	4x	Proprietary Status Reason	Error code.
		Mandatory	Validation: [1..1]
<Rsn>-</Rsn>	256x	Reason	Error description.
		Mandatory	Validation:

name of attribute	format	short description	description
			[1..1]
</PrtryRjctn>		End of ProprietaryStatusJustification Mandatory	Validation: [1..1]
</Rsn>		End of Reason Optional	Validation: [0..1]
</Sts>		End of PaymentStatus Optional	Validation: [0..1]
<InstdAmt>		Instructed Amount Optional	Validation: [0..1]
<AmtWthtCcy>-</AmtWthtCcy>	18n	Amount without currency Mandatory	Amount of the transaction . Validation: [1..1]
</InstdAmt>		End Instructed Amount Optional	Validation: [0..1]
<PmtMtd>		PaymentMethod Optional	PaymentMethod Validation: [0..1]
<FINMT>-</FINMT>	3!n	FINMessageType Mandatory	possible values: 103 202 204 Type of SWIFT FIN input message. It can be: "202" (MT 202) or "103" (MT103 and MT103+). Validation: [1..1]
</PmtMtd>		End Payment Method Optional	Validation: [0..1]
<PrcgVldtyTm>		ProcessingValidityTime Optional	This sequence is used to specify the date and the time of settlement. It will be present only if settlement already occurred. Validation: [0..1]
<FrDtTm>-</FrDtTm>	DateTime	From Date Time Mandatory	Settlement Date and Time (with UTC shift) (yyyy-mm-ddThh:mm:ss+ii:nn). Validation: [1..1]
</PrcgVldtyTm>		End Processing Validity Time Optional	Validation: [0..1]

name of attribute	format	short description	description
<Tp>		Type	Payment Type
		Optional	Validation: [0..1]
<Prtry>-</Prtry>		ProprietaryPaymentTypeCode	Proprietary Payment Type REGP = Regular Payment CONP = Connected Payment BACP = Backup Payment LIQP = Liquidity transfer via payments ASYP = Ancillary Systems Payments MANP= mandated payment INTP = interests PDDB = penalties BIDB = billing T2SL = T2S transactions TIPS = TIPS transactions Specifies transaction type. Possible values are: "CWD" (Cash Withdrawals); "LQT" (Liquidity Transfers) for transfers between accounts of the same participant, (including standing facilities transactions); "RGT" (Regular Transactions) for transfers between HAM accounts, or between HAM accounts and RTGS accounts of different participants; "RGP" (Regular Payments) for payments between CB customers, or between CB customers and RTGS accounts, or between CB customers and the account in HAM of the NCB (initiated by the NCB via Simplified MT 202); "BKT" (back up transactions) for transactions initiated by the NCB via ICM on behalf of the account owner in contingency situations; "HAM" (interests from HAM); "SFM" (interests from SF Module); "CRM" (billing from CRM); "RMM" (interests/penalties from RM module).
		Mandatory	Validation: [1..1]
</Tp>		End of Type	End of Payment Type
		Optional	Validation: [0..1]
<InstrCpy>-</InstrCpy>		Instruction Copy	FIN message.
		Optional	Validation: [0..1]
<Txld>-</Txld>	35x	TransactionIdentification	Unique and unambiguous identification of a payment transaction, as assigned by the originator. The payment transaction reference is used for reconciliation or to link tasks relating to the payment transaction. Transaction identifier, i.e. TRN of the SWIFT input message.
		Optional	Validation: [0..1]
<IntrBkSttlmDt>-</IntrBkSttlmDt>	ISODate	Value date	Value date Settlement date (with UTC shift) (yyyy-mm-dd+ii:nn).
		Optional	Validation: [0..1]
<EndToEndId>-</EndToEndId>	16x	EndToEndIdentification	Unique and unambiguous identification of a payment transaction, as assigned by any of the parties on the initiating side, that will be passed on throughout the entire end-to-end chain Related Reference, extracted from field 21 of the SWIFT input message.
		Optional	Validation: [0..1]

name of attribute	format	short description	description
<Pties>		Parties	PaymentTransactionParties needed for selection of Selection SWIFT FIN Fields
		Optional	Validation: [0..1]
<DbtrAgt>		Debtor Agent	Debtor Agent in SSP only <Mmbld> with BICFI possible
		Optional	Validation: [0..1]
<FinInstnId>		Financial Institution Identification	Financial Institution Identification
		Mandatory	Validation: [1..1]
<BICFI>-</BICFI>	4!a2!a2!c3!c	BICFIIdentifier	BICFIIdentifier Ordering institution, BIC extracted from field 52 of the SWIFT input message.
		Mandatory	Validation: [1..1]
</FinInstnId>		End of Financial Institution Identification	End of Financial Institution Identification
		Mandatory	Validation: [1..1]
</DbtrAgt>		End of Debtor Agent	End of Debtor Agent
		Optional	Validation: [0..1]
<InstgRmbrsmntAgt>		InstructingReimbursementAgent	
		Optional	Validation: [0..1]
<FinInstnId>		Financial Institution Identification	Financial Institution Identification
		Mandatory	Validation: [1..1]
<BICFI>-</BICFI>	4!a2!a2!c3!c	BICFIIdentifier	BICFIIdentifier Sender's Correspondent, BIC extracted from field 53 of the SWIFT input message.
		Mandatory	Validation: [1..1]
</FinInstnId>		End of Financial Institution Identification	End of Financial Institution Identification
		Mandatory	Validation: [1..1]
</InstgRmbrsmntAgt>		End of InstructingReimbursementAgent	
		Optional	Validation: [0..1]
<IntrmyAgt>		IntermediaryAgent	Intermediary
		Optional	Validation: [0..1]

name of attribute	format	short description	description
<FinInstnId>		Financial Institution Identification Mandatory	Financial Institution Identification Validation: [1..1]
<BICFI>-</BICFI>	4!a2!a2!c3!c	BICFIIdentifier Mandatory	BICFIIdentifier Intermediary, BIC extracted from field 56 of the SWIFT input message. Validation: [1..1]
</FinInstnId>		End of Financial Institution Identification Mandatory	End of Financial Institution Identification Validation: [1..1]
<IntrmyAgt>		IntermediaryAgent Mandatory	Intermediary Validation: [0..1]
<CdtrAgt>		CreditorAgent Optional	Final Agent Validation: [0..1]
<FinInstnId>		Financial Institution Identification Mandatory	Financial Institution Identification Validation: [1..1]
<BICFI>-</BICFI>	4!a2!a2!c3!c	BICFIIdentifier Mandatory	BICFIIdentifier Account With Institution, BIC extracted from field 57 of the SWIFT input message. Validation: [1..1]
</FinInstnId>		End of Financial Institution Identification Mandatory	End of Financial Institution Identification Validation: [1..1]
</CdtrAgt>		End of Creditor Agent Optional	End of Creditor Agent Validation: [0..1]
<Cdtr>		Creditor Optional	Creditor Validation: [0..1]
<FinInstnId>		Financial Institution Identification Mandatory	Financial Institution Identification Validation: [1..1]
<BICFI>-</BICFI>	4!a2!a2!c3!c	BICFIIdentifier Mandatory	BICFIIdentifier Creditor, BIC extracted from field 58 or 59 of the SWIFT input message. Validation: [1..1]
</FinInstnId>		End of Financial Institution Identification	End of Financial Institution Identification

name of attribute	format	short description	description
		Mandatory	Validation: [1..1]
</Cdtr>		End of Creditor Optional	Validation: [0..1]
</Pties>		End of Parties Optional	End Selection SWIFT FIN Fields Validation: [0..1]
</Pmt>		End Payment Optional	Validation: [0..1]
</Tx>		End of Transaction Mandatory	Validation: [1..1]
</TxOrErr>		End of TransactionOrErrorChoice Mandatory	Validation: [1..1]
</TxRpt>		End Transaction Report Mandatory	Validation: [1..n]
</BizRpt>		End of BusinessReport Mandatory	Validation: [1..1]
<OprlErr>		Operational Error Mandatory	Validation: [1..1]
<Err>		Error handling Mandatory	Validation: [1..1]
<Prtry>-</Prtry>	4x	Proprietary error code Mandatory	Specification of the error, in free format. Validation: [1..1]
</Err>		End error handling Mandatory	Validation: [1..1]
<Desc>-</Desc>	140x	Description Optional	Error description Validation: [0..1]
</OprlErr>		End of Operational Error Mandatory	End of Operational Error Validation: [1..1]
/xorBizRptOprlErr		End of choice	

name of attribute	format	short description	description
		Mandatory	Validation: [1..1]
</RptOrErr>		End of BusinessReportOrErrorChoi ce Mandatory	Validation: [1..1]
</RtrTx>		End messagename ReturnTransaction Mandatory	Validation: [1..1]

Error Codes:

ReturnTransaction_HAM_1

Scope: A response to a request of information on a specific transaction (see Get Transaction example 1).

MessageName for Return Transaction	<RtrTx>
Message Header	<MsgHdr>
Message Identification	<MsgId>AACDEFGHIJKLMNOPQRST123456789012345</MsgId>
Original Business Query	<OrgnlBizQry>
Message Identification	<MsgId>HACDEFGHIJKLMNOPQRST123456789012345</MsgId>
End of Original Business Query	</OrgnlBizQry>
End of Message Header	</MsgHdr>
BusinessReportOrErrorChoice	<RptOrErr>
BusinessReport	<BizRpt>
TransactionReport	<TxRpt>
PaymentIdentification	<PmtId>
ProprietaryId	<PrtryId>ABCDEFGHIHBBBBITRRXXX ABCDEFGHIHIL1234567890ABC</PrtryId>
EndPaymentIdentification	</PmtId>
TransactionOrErrorChoice	<TxOrErr>
Transaction	<Tx>
PaymentTo	<PmtTo>
Member Identification	<Mmbld>
Financial Institution Identification	<FinInstnId>
BICFIIdentifier	<BIC>IIIIITRRXXX</BIC>
End of Financial Institution Identification	</FinInstnId>
End Member Identification	</Mmbld>
End PaymentTo	</PmtTo>
Payment From	<PmtFr>
Member Identification	<Mmbld>
Financial Institution Identification	<FinInstnId>
BICFIIdentifier	<BIC>BBBBITRRXXX</BIC>
End of Financial Institution Identification	</FinInstnId>
End Member Identification	</Mmbld>
End Payment From	</PmtFr>
Credit or debit indicator	<CdtDbtInd>CRDT</CdtDbtInd>
Payment	<Pmt>
RequestedExecutionDate	<ReqdExctnDt>
Date Time	<DtTm>2008-09-12T08:30:47+01:00</DtTm>
End of RequestedExecutionDate	</ReqdExctnDt>
PaymentStatus	<Sts>
PaymentStatusCode	<Cd>
Final	<Fnl>STLD</Fnl>
End of PaymentStatusCode	</Cd>
DateTime	<DtTm>
Date Time	<DtTm>2008-09-12T09:30:47+01:00</DtTm>
End of DateTime	</DtTm>
End of PaymentStatus	</Sts>
Instructed Amount	<InstdAmt>
Amount without currency	<AmtWthtCcy>1234.56</AmtWthtCcy>
End Instructed Amount	</InstdAmt>
PaymentMethod	<PmtMtd>
FINMessageType	<FINMT>202</FINMT>
End Payment Method	</PmtMtd>
ProcessingValidityTime	<PrcgVldtyTm>

From Date Time	<FrDtTm>2008-09-12T09:30:47+01:00</FrDtTm>
End Processing Validity Time	</PrcgVldtyTm>
Type	<Tp>
ProprietaryPaymentTypeCode	<Prtry>RGP</Prtry>
End of Type	</Tp>
TransactionIdentification	<TxId>ABCDEFGHIL123456</TxId>
Value date	<IntrBkStlmdt>2008-09-12+01:00</IntrBkStlmdt>
EndToEndIdentification	<EndToEndId>ORIGINALTRAN</EndToEndId>
Parties	<Pties>
Debtor Agent	<DbtrAgt>
Financial Institution Identification	<FinInstnId>
BICFIIdentifier	<FrstAgt>FFFFITRRXXX</FrstAgt>
End of Financial Institution Identification	</FinInstnId>
End of Debtor Agent	</DbtrAgt>
InstructingReimbursementAgent	<InstgRmbrsmntAgt>
Financial Institution Identification	<FinInstnId>
BICFIIdentifier	<InstgAgtCrspdt>QQQITRRXXX</InstgAgtCrspdt>
End of Financial Institution Identification	</FinInstnId>
End of InstructingReimbursementAgent	</InstgRmbrsmntAgt>
IntermediaryAgent	<IntrmyAgt>
Financial Institution Identification	<FinInstnId>
BICFIIdentifier	<Intrmy>IIIIITRRXXX</Intrmy>
End of Financial Institution Identification	</FinInstnId>
IntermediaryAgent	<IntrmyAgt>
CreditorAgent	<CdtrAgt>
Financial Institution Identification	<FinInstnId>
BICFIIdentifier	<FnlAgt>FAFAITRRXXX</FnlAgt>
End of Financial Institution Identification	</FinInstnId>
End of Creditor Agent	</CdtrAgt>
Creditor	<Cdtr>
Financial Institution Identification	<FinInstnId>
BICFIIdentifier	<Cdtr>CCCCITRRXXX</Cdtr>
End of Financial Institution Identification	</FinInstnId>
End of Creditor	</Cdtr>
End of Parties	</Pties>
End Payment	</Pmt>
End ofTransaction	</Tx>
End of TransactionOrErrorChoice	</TxOrErr>
End Transaction Report	</TxRpt>
End of BusinessReport	</BizRpt>
End of BusinessReportOrErrorChoice	</RptOrErr>
End messagename ReturnTransaction	</RtrTx>

ReturnTransaction_HAM_2

Scope: A response to a request of information on all settled credit transactions (see Get Transaction example 2).

MessageName for Return Transaction	<RtrTx>
Message Header	<MsgHdr>
Message Identification	<MsgId>AACDEFGHIJKLMNOPQRST123456789012345</MsgId>
Original Business Query	<OrgnlBizQry>
Message Identification	<MsgId>HACDEFGHIJKLMNOPQRST123456789012345</MsgId>
End of Original Business Query	</OrgnlBizQry>
End of Message Header	</MsgHdr>
BusinessReportOrErrorChoice	<RptOrErr>
BusinessReport	<BizRpt>
TransactionReport	<TxRpt>
PaymentIdentification	<PmtId>
ProprietaryId	<PrtryId>ABCDEFGHIPPPPITMLXXX ABCDEFGHIJL1234567890ABC</PrtryId>
EndPaymentIdentification	</InstrRef>
TransactionOrErrorChoice	</PmtId>
Transaction	<Tx>
PaymentTo	<PmtTo>
Member Identification	<Mmbld>
Financial Institution Identification	<FinInstnId>
BICFIIdentifier	<BICFI>BBBBITRRXXX</BICFI>
End of Financial Institution Identification	</FinInstnId>
End Member Identification	</Mmbld>
End PaymentTo	</PmtTo>
Payment From	<PmtFr>
Member Identification	<Mmbld>
Financial Institution Identification	<FinInstnId>
BICFIIdentifier	<BICFI>PPPPITMLXXX</BICFI>
End of Financial Institution Identification	</FinInstnId>
End Member Identification	</Mmbld>
End Payment From	</PmtFr>
Credit or debit indicator	<CdtDbtInd>CRDT</CdtDbtInd>
Payment	<Pmt>
RequestedExecutionDate	<ReqdExctnDt>
Date Time	<DtTm>2007-08-13T08:30:47+01:00</DtTm>
End of RequestedExecutionDate	</ReqdExctnDt>
PaymentStatus	<Sts>
PaymentStatusCode	<Cd>
Final	<Fnl>STLD</Fnl>
End of PaymentStatusCode	</Cd>
DateTime	<DtTm>
Date Time	<DtTm>2007-08-13T08:30:47+01:00</DtTm>
End of DateTime	</DtTm>
End of PaymentStatus	</Sts>
Instructed Amount	<InstdAmt>
Amount without currency	<AmtWthtCcy>4321.56</AmtWthtCcy>
End Instructed Amount	</InstdAmt>
PaymentMethod	<PmtMtd>
FINMessageType	<FINMT>202</FINMT>
End Payment Method	</PmtMtd>
ProcessingValidityTime	<PrcgVldtyTm>

From Date Time	<FrDtTm>2007-08-13T09:30:47+01:00</FrDtTm>
End Processing Validity Time	</PrcgVldtyTm>
Type	<Tp>
ProprietaryPaymentTypeCode	<Prtry>RGT</Prtry>
End of Type	</Tp>
TransactionIdentification	<TxId>ABCDDDDDD123456</TxId>
Value date	<IntrBkSttlmDt>2007-08-13+01:00</IntrBkSttlmDt>
EndToEndIdentification	<EndToEndId>ORIGINALTRAN</EndToEndId>
Parties	<Pties>
InstructingReimbursementAgent	<InstgRmbrsmntAgt>
Financial Institution Identification	<FinInstnId>
BICFIIdentifier	<BICFI>PPPPITMLXXX</BICFI>
End of Financial Institution Identification	</FinInstnId>
End of InstructingReimbursementAgent	</InstgRmbrsmntAgt>
Creditor	<Cdtr>
Financial Institution Identification	<FinInstnId>
BICFIIdentifier	<BICFI>BBBBITRRXXX</BICFI>
End of Financial Institution Identification	</FinInstnId>
End of Creditor	</Cdtr>
End of Parties	</Pties>
End Payment	</Pmt>
End of Transaction	</Tx>
End of TransactionOrErrorChoice	</TxOrErr>
End Transaction Report	</TxRpt>
End of BusinessReport	</BizRpt>
End of BusinessReportOrErrorChoice	</RptOrErr>
End messagename ReturnTransaction	</RtrTx>

ReturnTransaction_HAM_3

Scope: A response to a request on all debit transactions sent by the co-manager (BBBBITRRXXX) on behalf of the account owner (PPPPITRRXXX). (see Get Transaction example 3).

MessageName for Return Transaction	<RtrTx>
Message Header	<MsgHdr>
Message Identification	<MsgId>AACDEFGHIJKLMNOPQRST123456789012345</MsgId>
Original Business Query	<OrgnlBizQry>
Message Identification	<MsgId>HACDEFGHIJKLMNOPQRST123456789012345</MsgId>
End of Original Business Query	</OrgnlBizQry>
End of Message Header	</MsgHdr>
BusinessReportOrErrorChoice	<RptOrErr>
BusinessReport	<BizRpt>
TransactionReport	<TxRpt>
PaymentIdentification	<PmtId>
ProprietaryId	<PrtryId>ABCDEFGHIIBBBBBITRRXXX ABCDEFGHIIL1234567890ABC</PrtryId>
EndPaymentIdentification	</PmtId>
TransactionOrErrorChoice	<TxOrErr>
Transaction	<Tx>
PaymentTo	<PmtTo>
Member Identification	<Mmbld>
Financial Institution Identification	<FinInstnId>
BICFIIdentifier	<BICFI>PPPPITRRXXX</BICFI>
End of Financial Institution Identification	</FinInstnId>
End Member Identification	</Mmbld>
End PaymentTo	</PmtTo>
Payment From	<PmtFr>
Member Identification	<Mmbld>
Financial Institution Identification	<FinInstnId>
BICFIIdentifier	<BICFI>CCCCIT3PXXX</BICFI>
End of Financial Institution Identification	</FinInstnId>
End Member Identification	</Mmbld>
End Payment From	</PmtFr>
Credit or debit indicator	<CdtDbtInd>DBIT</CdtDbtInd>
Payment	<Pmt>
RequestedExecutionDate	<ReqdExctnDt>
Date Time	<DtTm>2007-05-11T09:30:47+01:00</DtTm>
End of RequestedExecutionDate	</ReqdExctnDt>
PaymentStatus	<Sts>
PaymentStatusCode	<Cd>
Pending	<Pdg>STLE</Pdg>
End of PaymentStatusCode	</Cd>
DateTime	<DtTm>
Date Time	<DtTm>2007-05-10T09:30:47+01:00</DtTm>
End of DateTime	</DtTm>
End of PaymentStatus	</Sts>
Instructed Amount	<InstdAmt>
Amount without currency	<AmtWthtCcy>1234.56</AmtWthtCcy>
End Instructed Amount	</InstdAmt>
PaymentMethod	<PmtMtd>
FINMessageType	<FINMT>202</FINMT>
End Payment Method	</PmtMtd>
Type	<Tp>

ProprietaryPaymentTypeCode							< Prtry>RGT</Prtry>
End of Type							</Tp>
TransactionIdentification							<Txld>ABCDEFGHIL123456</Txld>
Value date							<IntrBkSttlmDt>2007-05-13+01:00</IntrBkSttlmDt>
EndToEndIdentification							<EndToEndId>ORIGINALTRAN</EndToEndId>
Parties							<Pties>
InstructingReimbursementAgent							<InstgRmbrsmntAgt>
Financial Institution Identification							<FinInstnId>
BICFIIdentifier							<BICFI>PPPPITRRXX</BICFI>
End of Financial Institution Identification							</FinInstnId>
End of InstructingReimbursementAgent							</InstgRmbrsmntAgt>
Creditor							<Cdtr>
Financial Institution Identification							<FinInstnId>
BICFIIdentifier							<BICFI>CCCCIT3PXXX</BICFI>
End of Financial Institution Identification							</FinInstnId>
End of Creditor							</Cdtr>
End of Parties							</Pties>
End Payment							</Pmt>
End ofTransaction							</Tx>
End of TransactionOrErrorChoice							</TxOrErr>
End Transaction Report							</TxRpt>
End of BusinessReport							</BizRpt>
End of BusinessReportOrErrorChoice							</RptOrErr>
End message ReturnTransaction							</RtrTx>

ReturnTransaction_HAM_4

Scope: A response to a request on the input FIN message information of a specific transaction identified through an external transfer identifier (see Get Transaction example 4).

MessageName for Return Transaction	<RtrTx>
Message Header	<MsgHdr>
Message Identification	<MsgId>ABCDEFGHIJKLMNQRST123456789012345</MsgId>
Original Business Query	<OrgnlBizQry>
Message Identification	<MsgId>HACDEFGHIJKLMNQRST123456789012345</MsgId>
End of Original Business Query	</OrgnlBizQry>
End of Message Header	</MsgHdr>
BusinessReportOrErrorChoice	<RptOrErr>
BusinessReport	<BizRpt>
TransactionReport	<TxRpt>
PaymentIdentification	<PmtId>
ProprietaryId	<PrtryId>ABCDEFGHI1234567890ABCDEFGHI1234567890A BC</PrtryId>
EndPaymentIdentification	</PmtId>
TransactionOrErrorChoice	<TxOrErr>
Transaction	<Tx>
Payment	<Pmt>
RequestedExecutionDate	<ReqdExctnDt>
Date Time	<DtTm>2007-08-13T09:30:47+01:00</DtTm>
End of RequestedExecutionDate	</ReqdExctnDt>
PaymentStatus	<Sts>
PaymentStatusCode	<Cd>
Final	<FnI>STLD</FnI>
End of PaymentStatusCode	</Cd>
End of PaymentStatus	</Sts>
PaymentMethod	<PmtMtd>
FINMessageType	<FINMT>103</FINMT>
End Payment Method	</PmtMtd>
Instruction Copy	<InstrCpy>an MT103 FIN Message</InstrCpy>
TransactionIdentification	<TxId>ABCDEFGHI123456</TxId>
End Payment	</Pmt>
End of Transaction	</Tx>
End of TransactionOrErrorChoice	</TxOrErr>
End Transaction Report	</TxRpt>
End of BusinessReport	</BizRpt>
End of BusinessReportOrErrorChoice	</RptOrErr>
End messageName ReturnTransaction	</RtrTx>

ReturnTransaction_HAM_5

Scope: A response to a request on Request of information on all debit Regular Transactions (RGT): sent by the co-manager (SSSSITRRXXX), on behalf of the account owner (OOOOITRRXXX), towards a country (NL), arrived in HAM in a range of time (2008-05-02T10-00-00 - 2008-05-02T10-04-59), to be settled in the same date, rejected with a specific return code (X102), in a range of amount (1000000,01 - 1000100,00) (see Get Transaction example 5).

MessageName for Return Transaction	<RtrTx>
Message Header	<MsgHdr>
Message Identification	<MsgId>HACDEFGHIJKLMNOPQRST123456789012345</MsgId>
Original Business Query	<OrgnlBizQry>
Message Identification	<MsgId>ABCDEFGHIJKLMNQRST12345678912345</MsgId>
End of Original Business Query	</OrgnlBizQry>
End of Message Header	</MsgHdr>
BusinessReportOrErrorChoice	<RptOrErr>
BusinessReport	<BizRpt>
TransactionReport	<TxRpt>
PaymentIdentification	<PmtId>
ProprietaryId	<PrtryId>ABCDEFGHIJ1234567890ABCDEFGHIJ1234567890A BC</PrtryId>
EndPaymentIdentification	</PmtId>
TransactionOrErrorChoice	<TxOrErr>
Transaction	<Tx>
PaymentTo	<PmtTo>
Member Identification	<Mmbld>
Financial Institution Identification	<FinInstnId>
BICFIIdentifier	<BICFI>OOOOITRRXXX</BICFI>
End of Financial Institution Identification	</FinInstnId>
End Member Identification	</Mmbld>
End PaymentTo	</PmtTo>
Payment From	<PmtFr>
Member Identification	<Mmbld>
Financial Institution Identification	<FinInstnId>
BICFIIdentifier	<BICFI>AAAAD3PXXX</BICFI>
End of Financial Institution Identification	</FinInstnId>
End Member Identification	</Mmbld>
End Payment From	</PmtFr>
Credit or debit indicator	<CdtDbtInd>DBIT</CdtDbtInd>
Payment	<Pmt>
RequestedExecutionDate	<ReqdExctnDt>
Date Time	<DtTm>2008-05-02T10:01:33+01:00</DtTm>
End of RequestedExecutionDate	</ReqdExctnDt>
PaymentStatus	<Sts>
PaymentStatusCode	<Cd>
Final	<Fnl>RJTD</Fnl>
End of PaymentStatusCode	</Cd>
DateTime	<DtTm>
Date Time	<DtTm>2008-05-02T10:01:44+01:00</DtTm>
End of DateTime	</DtTm>
Reason	<Rsn>
ProprietaryStatusJustification	<PrtryRjctn>
Proprietary Status Reason	<PrtryStsRsn>X102</PrtryStsRsn>
Reason	<Rsn>MISSING RECEIVING LEGITIMACY</Rsn>
End of ProprietaryStatusJustification	</PrtryRjctn>
End of Reason	</Rsn>

6. 8 XML messages related to SF

6. 8. 1 GetAccount

Cash Management Standard

GetAccount_SF

Scope: The Get Account Message is used by account holders (or by the co-managers, NCB or the Collateral manager on behalf of the account holder) to request information about the balance of the marginal lending account and the overnight deposit account. This message will be replied by a Return Account Message.

<camt.003.001.xx>

Structure:

Message Type	<GetAcct>
Message Header	<MsgHdr>
Message Identification	<MsgId></MsgId>
End of Message Header	</MsgHdr>
Specification of the query criteria.	<AcctQryDef>
Account Criteria	<AcctCrit>
NewCriteria	<NewCrit>
SearchCriteria	<SchCrit>
CashAccountType	<Tp>
ExternalCashAccountTypeCode	<Cd></Cd>
End of CashAccountType	</Tp>
Account Owner	<AcctOwnr>
Identification	<Id>
OrganisationIdentification	<OrgId>
AnyBICIdentifier	<AnyBIC></AnyBIC>
End of OrganisationIdentification	</OrgId>
End Identification	</Id>
End of Account owner	</AcctOwnr>
End of SearchCriteria	</SchCrit>
End of NewCriteria	</NewCrit>
End Account Criteria	</AcctCrit>
End Account Query Definition	</AcctQryDef>
End of Message Type	</GetAcct>

Attributes:

name of attribute	format	short description	description
<GetAcct>		Message Type	Message name for GetAccount
		Mandatory	Validation: [1..1]
<MsgHdr>		Message Header	Set of characteristics specific to the message
		Mandatory	Validation: [1..1]
<MsgId>-</MsgId>	35x	Message Identification	Message Identification
			String of characters that uniquely identifies a message at senders side.
		Mandatory	Validation: [1..1]
</MsgHdr>		End of Message Header	
		Mandatory	Validation: [1..1]
<AcctQryDef>		Specification of the query criteria.	
		Mandatory	Validation: [0..1]
<AcctCrit>		Account Criteria	
		Mandatory	Validation: [0..1]
<NewCrit>		NewCriteria	
		Mandatory	Validation: [1..1]
<SchCrit>		SearchCriteria	
		Mandatory	Validation: [0..1]
<Tp>		CashAccountType	CashAccountType
		Optional	Validation: [0..2]
<Cd>-</Cd>		ExternalCashAccountType Code	ExternalCashAccountTypeCode
			SSP restricted code list:
			CACC = Current Account used to post debits and credits when no specific account has been nominated
			SACC = Settlement Account used to post debit and credit entries, as a result of transactions cleared and settled through a specific clearing and settlement system.
			Account type. It can be: "ONDP" (Overnight Deposit) or "MGLD" (Marginal Lending). The requestor can ask both ONDP and MGLD in the same message. The Collateral Manager can ask only information related to the Marginal Lending account.
		Mandatory	Validation: [1..1]
</Tp>		End of CashAccountType	End of CashAccountType

name of attribute	format	short description	description
		Optional	Validation: [0..2]
<AcctOwnr>		Account Owner Optional	Validation: [0..1]
<Id>		Identification Mandatory	Identification Unique and unambiguous identification for the account between the account owner and the account servicer. Validation: [1..1]
<OrgId>		OrganisationIdentification Mandatory	OrganisationIdentification Validation: [1..1]
<AnyBIC>-</AnyBIC>	4!a2!a2!c[3!cAnyBICIdentifier]	Optional	AnyBICIdentifier / BIC used on behalf of third parties Specifies the participant to whom data are referred. The attribute is mandatory when the requestor is the co-manager, the Collateral Manager of the participant, or the NCB. Validation: [0..1]
</OrgId>		End of OrganisationIdentification Mandatory	End of OrganisationIdentification Validation: [1..1]
</Id>		End Identification Mandatory	Validation: [1..1]
</AcctOwnr>		End of Account owner Optional	Validation: [0..1]
</SchCrit>		End of SearchCriteria Mandatory	Validation: [0..1]
</NewCrit>		End of NewCriteria Mandatory	Validation: [1..1]
</AcctCrit>		End Account Criteria Mandatory	Validation: [0..1]
</AcctQryDef>		End Account Query Definition Mandatory	Validation: [0..1]
</GetAcct>		End of Message Type Mandatory	End of GetAccount Validation: [1..1]

Error Codes:

Order	Error code				Error Text / Validation/ Remark
	SSP	Y-copy	V-shape	XML	
1	X41			1401	Error Text: No permission. RBAC User role(s) are not sufficient. Validation: RBAC role name "APPLICATE", "APPLICSTE" or "APPLICBTE" are required Remark: checked by ICM / ReturnAccount
2	H04	M4	XT16	H004	Error Text: Operation not allowed (e.g. cross border) Validation: Remark:
3	866	C6	AC06	2866	Error Text: Exclusion of participant Validation: Remark:
4	H12			H012	Error Text: Requested BIC missing in input Validation: Remark:
5	H11			H011	Error Text: Requested BIC unknown Validation: Remark:
6	H08			H008	Error Text: Requestor unknown Validation: Remark:
7	H07	M7		H007	Error Text: Account not open Validation: Remark:
8	H01		XI01	H001	Error Text: Sender not allowed Validation: Remark:

GetAccount_SF_1

Scope: Request of information about the overnight deposit account balance. The requestor is the account holder.

Message Type	<GetAcct>
Message Header	<MsgHdr>
Message Identification	<MsgId>ABCDEFGHIJKLMNQRST123456789012345</MsgId>
End of Message Header	</MsgHdr>
Specification of the query criteria.	<AcctQryDef>
Account Criteria	<AcctCrit>
NewCriteria	<NewCrit>
SearchCriteria	<SchCrit>
CashAccountType	<Tp>
ExternalCashAccountTypeCode	<Cd>ONDP</Cd>
End of CashAccountType	</Tp>
End of SearchCriteria	</SchCrit>
End of NewCriteria	</NewCrit>
End Account Criteria	</AcctCrit>
End Account Query Definition	</AcctQryDef>
End of Message Type	</GetAcct>

GetAccount_SF_2

Scope: Request of information about the marginal lending account balance. The requestor is the NCB of the account holder.

Message Type	<GetAcct>
Message Header	<MsgHdr>
Message Identification	<MsgId>SFCDEFGHIJKLMNOPQRST123456789012345</MsgId>
End of Message Header	</MsgHdr>
Specification of the query criteria.	<AcctQryDef>
Account Criteria	<AcctCrit>
NewCriteria	<NewCrit>
SearchCriteria	<SchCrit>
CashAccountType	<Tp>
ExternalCashAccountTypeCode	<Cd>MGLD</Cd>
End of CashAccountType	</Tp>
Account Owner	<AcctOwncr>
Identification	<Id>
OrganisationIdentification	<OrgId>
AnyBICIdentifier	<AnyBIC>BBBBITRRXX</AnyBIC>
End of OrganisationIdentification	</OrgId>
End Identification	</Id>
End of Account owner	</AcctOwncr>
End of SearchCriteria	</SchCrit>
End of NewCriteria	</NewCrit>
End Account Criteria	</AcctCrit>
End Account Query Definition	</AcctQryDef>
End of Message Type	</GetAcct>

6. 8. 2 GetTransaction

Cash Management Standard

GetTransaction_SF

Scope: The Get Transaction Message is used by account holders (or by Co-managers and NCBs on behalf of the account holder) to request information about Standing Facilities (Marginal Lending and Overnight Deposit) transactions. The message can be used also by the Collateral Manager to request information about Marginal Lending transactions on behalf of the account holder.

Business Data Compression via delta sets is supported. GetTransaction message can be performed with the query type "CHNG", "MODF" or "DELD".

This message will be replied by a Return Transaction Message.

<camt.005.001.xx>

Structure:

MessageName for GetTransaction	<GetTx>
Message Header	<MsgHdr>
Message Identification	<MsgId></MsgId>
End of Message Header	</MsgHdr>
Transaction Query Definition	<TxQryDef>
QueryTypeCode	<QryTp></QryTp>
Transaction Criteria	<TxCrit>
choice amongst	xorQryNmNewCrit
QueryName	<QryNm></QryNm>
NewCriteria	<NewCrit>
SearchCriteria	<SchCrit>
PaymentTo	<PmtTo>
Member Identification	<Mmbld>
Financial Institution Identification	<FinInstnId>
BICFIIdentifier	<BICFI></BICFI>
End of Financial Institution Identification	</FinInstnId>
End Member Identification	</Mmbld>
End PaymentTo	</PmtTo>
Payment From	<PmtFr>
Member Identification	<Mmbld>
Financial Institution Identification	<FinInstnId>
BICFIIdentifier	<BICFI></BICFI>
End of Financial Institution Identification	</FinInstnId>
End of Member Identification	</Mmbld>
End Payment From	</PmtFr>
Payment Search	<PmtSch>
Credit or debit indicator	<CdtDbtInd></CdtDbtInd>
Payment Type	<PmtTp>
Payment type code	<Cd></Cd>
End Payment Type	</PmtTp>
End Payment Search	</PmtSch>
End of SearchCriteria	</SchCrit>
End of NewCriteria	</NewCrit>
End choice amongst	/xorQryNmNewCrit
End Transaction Criteria	</TxCrit>
End Transaction Query Definition	</TxQryDef>
End of MessageName for GetTransaction	</GetTx>

Attributes:

name of attribute	format	short description	description
<GetTx>		Message name for GetTransaction Mandatory	Message name for GetTransaction Validation: [1..1]
<MsgHdr>		Message Header Mandatory	Set of characteristics specific to the message Validation: [1..1]
<MsgId>-</MsgId>	35x	Message Identification Mandatory	Message Identification String of characters that uniquely identifies a message at senders side. Validation: [1..1]
</MsgHdr>		End of Message Header Mandatory	Validation: [1..1]
<TxQryDef>		Transaction Query Definition Mandatory	Validation: [0..1]
<QryTp>-</QryTp>		QueryTypeCode Optional	Specifies the nature of the query, i.e. whether the query requests that all matching items be returned or only new matching items since the last similar query be returned. ALLL = All Specifies that the query requests that all matching items be returned. CHNG = Changes Specifies that the query requests that only new matching items since the last similar query be returned. MODF = Modified Specifies that the query requests to return only items that have changed since the last query. DELD = Deleted Specifies that the query requests to return only items that were deleted since the last query. Further details can be found in the general chapter for delta set retrieval. Validation: [0..1]
<TxCrit>		Transaction Criteria Mandatory	Validation: [0..1]
xorQryNmNewCrit		choice amongst Mandatory	TransactionCriteriaDefinitionChoice QueryName and NewCriteria Defines the information that is searched either implicitly by recalling a previous query or explicitly by defining the criteria. QueryName [1..1] Max35Text TransactionCriteriaDefinitionChoice NewCriteria [1..1] TransactionCriteria Validation: [1..1]

name of attribute	format	short description	description
<QryNm>	35x	QueryName	Recalls the criteria (search and return criteria) defined in a preceding query. Identifier of a preceding message. The cross-reference is used for the creation of delta sets
		Mandatory	Validation: [1..1]
<NewCrit>		NewCriteria	
		Mandatory	Validation: [1..1]
<SchCrit>		SearchCriteria	
		Optional	Validation: [0..n]
<PmtTo>		PaymentTo	This section is used to specify the participant to whom standing facilities transactions are referred (creditor). It is mandatory when the requestor is the co-manager, the Collateral Manager of the participant, or the NCB. When valorised, the sections <PmtTo> and <PmtFr> must contain the same BIC.
		Optional	Validation: [0..1]
<Mmbld>		Member Identification	
		Optional	Validation: [0..1]
<FinInstnId>		Financial Institution Identification	Financial Institution Identification
		Mandatory	Validation: [1..1]
<BICFI>--</BICFI>	4!a2!a2!c3!c	BICFIIdentifier	BICFIIdentifier
		Mandatory	Validation: [1..1]
</FinInstnId>		End of Financial Institution Identification	End of Financial Institution Identification
		Mandatory	Validation: [1..1]
</Mmbld>		End Member Identification	
		Optional	Validation: [0..1]
</PmtTo>		End PaymentTo	
		Optional	Validation: [0..1]
<PmtFr>		Payment From	This section is used to specify the participant to whom standing facilities transactions are referred (debtor). It can be used only once (repetition is not allowed) and is mandatory when the requestor is the co-manager, the Collateral Manager of the participant or the NCB. When valorised, the sections <PmtTo> and <PmtFr> must contain the same BIC.
		Optional	Validation: [0..1]

name of attribute	format	short description	description
<MmblId>		Member Identification Optional	Validation: [0..1]
<FinInstnId>		Financial Institution Identification Mandatory	Validation: [1..1]
<BICFI>-</BICFI>	4!a2!a2!c3!c	BICFIIdentifier Mandatory	Validation: [1..1]
</FinInstnId>		End of Financial Institution Identification Mandatory	Validation: [1..1]
</MmblId>		End of Member Identification Optional	Validation: [0..1]
</PmtFr>		End Payment From Optional	Validation: [0..1]
<PmtSch>		Payment Search Mandatory	Validation: [0..1]
<CdtDbtInd>-</CdtDbtInd>	4!a	Credit or debit indicator Optional	Credit debit indicator. It is used to select credit or debit transactions. If valorised, it can be: "CRDT" (credit) or "DBIT" (debit). If not used both debit and credit transactions will be returned. NOTE: Credit debit indicator is always referred to the SFM part of the transaction, e.g. for overnight deposit setting up is CRDT, while marginal lending setting up is DBIT. Validation: [0..1]
<PmtTp>		Payment Type Optional	Payment Type This section is used to specify the type of transactions to select (Marginal Lending, Overnight Deposits). If not used both types of transactions will be returned. Validation: [0..2]
<Cd>-</Cd>	PaymentTyp e3Code	Payment type code Mandatory	Payment type code SSP restricted code list: CLS Transaction type. It can be: "MGL" (for Marginal Lending) and "OND" (for Overnight Deposit). Validation: [1..1]
</PmtTp>		End Payment Type Optional	Validation: [0..2]
</PmtSch>		End Payment Search	

name of attribute	format	short description	description
		Mandatory	Validation: [0..1]
</SchCrit>		End of SearchCriteria Mandatory	Validation: [0..1]
</NewCrit>		End of NewCriteria Mandatory	Validation: [0..1]
/xorQryNmNewCrit		End choice amongst Mandatory	end choice amongst TransactionCriteriaDefinitionChoice Validation: [1..1]
</TxCrit>		End Transaction Criteria Mandatory	Validation: [0..1]
</TxQryDef>		End Transaction Query Definition Mandatory	Validation: [0..1]
</GetTx>		End of Messagename for GetTransaction Mandatory	Validation: [1..1]

Error Codes:

Order	Error code				Error Text / Validation/ Remark
	SSP	Y-copy	V-shape	XML	
1	X41			1401	Error Text: No permission. RBAC User role(s) are not sufficient. Validation: RBAC role name "APPLICATE", "APPLICSTE" or "APPLICBTE" are required Remark: checked by ICM / ReturnTransaction
2	866	C6	AC06	2866	Error Text: Exclusion of participant Validation: Remark:
3	H12			H012	Error Text: Requested BIC missing in input Validation: Remark:
4	H11			H011	Error Text: Requested BIC unknown Validation: Remark:
5	H08			H008	Error Text: Requestor unknown Validation: Remark:
6	H06			H006	Error Text: No data available (e.g. an empty list) Validation: Remark:
7	H04	M4	XT16	H004	Error Text: Operation not allowed (e.g. cross border) Validation: Remark:
8	H01		XI01	H001	Error Text: Sender not allowed Validation: Remark:

GetTransaction_SF_1

Scope: Request of information about all standing facilities transactions of a participant. The requestor is the participant.

Messagename for GetTransaction	<GetTx>
Message Header	<MsgHdr>
Message Identification	<MsgId>SFCDEFGHIJKLMNOPQRST123456789012345</MsgId>
End of Message Header	</MsgHdr>
Transaction Query Definition	<TxQryDef>
Transaction Criteria	<TxCrit>
NewCriteria	<NewCrit>
SearchCriteria	<SchCrit>
Payment Search	<PmtSch>
Payment Type	<PmtTp>
Payment type code	<Cd>MGL</Cd>
End Payment Type	</PmtTp>
Payment Type	<PmtTp>
Payment type code	<Cd>OND</Cd>
End Payment Type	</PmtTp>
End Payment Search	</PmtSch>
End of SearchCriteria	</SchCrit>
End of NewCriteria	</NewCrit>
End Transaction Criteria	</TxCrit>
End Transaction Query Definition	</TxQryDef>
End of Messagename for GetTransaction	</GetTx>

GetTransaction_SF_2

Scope: Request of information about standing facilities transactions of a participant. The requestor is the NCB of the participant.

Messagename for GetTransaction	<GetTx>
Message Header	<MsgHdr>
Message Identification	<MsgId> SFCDEFGHIJKLMNOPQRST123456789012345</MsgId>
End of Message Header	</MsgHdr>
Transaction Query Definition	<TxQryDef>
Transaction Criteria	<TxCrit>
NewCriteria	<NewCrit>
SearchCriteria	<SchCrit>
PaymentTo	<PmtTo>
Member Identification	<Mmbld>
Financial Institution Identification	<FinInstnId>
BICFIIdentifier	<BICFI>BBBBIT22XXX</BICFI>
End of Financial Institution Identification	</FinInstnId>
End Member Identification	</Mmbld>
End PaymentTo	</PmtTo>
Payment From	<PmtFr>
Member Identification	<Mmbld>
Financial Institution Identification	<FinInstnId>
BICFIIdentifier	<BICFI>BBBBIT22XXX</BICFI>
End of Financial Institution Identification	</FinInstnId>
End of Member Identification	</Mmbld>
End Payment From	</PmtFr>
Payment Search	<PmtSch>
Payment Type	<PmtTp>
Payment type code	<Cd>OND</Cd>
End Payment Type	</PmtTp>
Payment Type	<PmtTp>
Payment type code	<Cd>MGL</Cd>
End Payment Type	</PmtTp>
End Payment Search	</PmtSch>
End of SearchCriteria	</SchCrit>
End of NewCriteria	</NewCrit>
End Transaction Criteria	</TxCrit>
End Transaction Query Definition	</TxQryDef>
End of Messagename for GetTransaction	</GetTx>

6. 8. 3 LiquidityCreditTransfer

Cash Management Standard

LiquidityCreditTransfer_SF

Scope: The LiquidityCreditTransfer message is used by account holders (or by Co-managers and NCBs on behalf of the account holder) for setting up the overnight deposit operation and for the overnight deposit reverse transaction. It is also used by NCBs for setting up the marginal lending operation.

This message will be replied by a Receipt message.
Non repudiation of emission (NRE) is mandatory.

<camt.050.001.xx>

Structure:

Message name for LiquidityCreditTransfer	<LqdyCdtTrf>
Message Header	<MsgHdr>
Message Identification	<MsgId></MsgId>
End of Message Header	</MsgHdr>
LiquidityCreditTransfer1	<LqdyCdtTrf>
CreditorAccount	<CdtrAcct>
Identification	<Id>
GenericAccountIdentification	<Othr>
AccountIdentification	<Id></Id>
End of GenericAccountIdentification	</Othr>
End Identification	</Id>
CashAccountType	<Tp>
ExternalCashAccountTypeCode	<Cd></Cd>
End of CashAccountType	</Tp>
EndCreditorAccount	</CdtrAcct>
Amount	<TrfdAmt>
Amount without currency	<AmtWthtCcy></AmtWthtCcy>
End of Transferred Amount	</TrfdAmt>
DebtorAccount	<DbtrAcct>
Identification	<Id>
GenericAccountIdentification	<Othr>
AccountIdentification	<Id></Id>
End of GenericAccountIdentification	</Othr>
End Identification	</Id>
CashAccountType	<Tp>
ExternalCashAccountTypeCode	<Cd></Cd>
End of CashAccountType	</Tp>
EndDebtorAccount	</DbtrAcct>
End of LiquidityCreditTransfer1	</LqdyCdtTrf>
End message name LiquidityCreditTransfer	</LqdyCdtTrf>

Attributes:

name of attribute	format	short description	description
<LqdyCdtTrf>		Message name for LiquidityCreditTransfer Mandatory	Message name for LiquidityCreditTransfer Validation: [1..1]
<MsgHdr>		Message Header Mandatory	Set of characteristics specific to the message Validation: [1..1]
<MsgId>-</MsgId>	35x	Message Identification Mandatory	Message Identification String of characters that uniquely identifies a message at senders side. The first 16 characters must be unique (TRN) and consistent with "X SWIFT Character Set", including exceptions as per SWIFT "Message Format Validations Rules" related to field 20 and 21. Validation: [1..1]
</MsgHdr>		End of Message Header Mandatory	Validation: [1..1]
<LqdyCdtTrf>		LiquidityCreditTransfer1 Mandatory	LiquidityCreditTransfer Validation: [1..1]
<CdtrAcct>		CreditorAccount Mandatory	This section is mandatory for the SF module. Validation: [0..1]
<Id>		Identification Mandatory	Validation: [1..1]
<Othr>		GenericAccountIdentification Mandatory	GenericAccountIdentification Validation: [1..1]
<Id>-</Id>	BICFI	AccountIdentification Mandatory	AccountIdentification BIC of the account to be credited. Validation: [1..1]
</Othr>		End of GenericAccountIdentification Mandatory	End of GenericAccountIdentification Validation: [1..1]
</Id>		End Identification Mandatory	Validation: [1..1]
<Tp>		CashAccountType Optional	CashAccountType Validation: [0..1]

name of attribute	format	short description	description
<Cd>-</Cd>		ExternalCashAccountType Code	ExternalCashAccountTypeCode SSP restricted code list: CACC = Current Account used to post debits and credits when no specific account has been nominated SACC = Settlement Account used to post debit and credit entries, as a result of transactions cleared and settled through a specific clearing and settlement system. Type of the account to be credited. It must be valorised only when a Standing Facilities account has to be credited (overnight deposit setting up). (When the account to be credited is not a Standing Facilities account, the SFM singles out automatically if the counterpart account is in PM or in HAM). If valorised, it can be only: "ONDP" (overnight deposit).
		Optional	Validation: [0..1]
</Tp>		End of CashAccountType	End of CashAccountType
		Optional	Validation: [0..1]
</CdtrAcct>		EndCreditorAccount	
		Mandatory	Validation: [0..1]
<TrfdAmt>		Amount	
		Mandatory	Validation: [1..1]
<AmtWthtCcy>-</AmtWthtCcy>	14n	Amount without currency	Amount .
		Mandatory	Validation: [1..1]
</TrfdAmt>		End of Transferred Amount	
		Mandatory	Validation: [1..1]
<DbtrAcct>		DebtorAccount	This section is mandatory for the SF module.
		Mandatory	Validation: [0..1]
<Id>		Identification	
		Mandatory	Validation: [1..1]
<Othr>		GenericAccountIdentificatio n	GenericAccountIdentification
		Mandatory	Validation: [1..1]
<Id>-</Id>	BICFI	AccountIdentification	AccountIdentification BIC of the account to be debited.
		Mandatory	Validation: [1..1]
</Othr>		End of GenericAccountIdentificatio n	End of GenericAccountIdentification

name of attribute	format	short description	description
		Mandatory	Validation: [1..1]
</ld>		End Identification	
		Mandatory	Validation: [1..1]
<Tp>		CashAccountType	CashAccountType
		Optional	Validation: [0..1]
<Cd>-</Cd>		ExternalCashAccountType Code	ExternalCashAccountTypeCode SSP restricted code list: CACC = Current Account used to post debits and credits when no specific account has been nominated SACC = Settlement Account used to post debit and credit entries, as a result of transactions cleared and settled through a specific clearing and settlement system. Type of the account to be debited. It must be valorised only when a Standing Facilities account has to be debited (marginal lending setting up or overnight deposit reverse transaction). (When the account to be debited is not a Standing Facilities account, the SFM singles out automatically if the counterpart account is in PM or in HAM). If valorised, it can be: "MGLD" (marginal lending) or "ONDP" (overnight deposit).
		Optional	Validation: [0..1]
</Tp>		End of CashAccountType	End of CashAccountType
		Optional	Validation: [0..1]
</DbtrAcct>		EndDebtorAccount	
		Mandatory	Validation: [0..1]
</LqdyCdtTrf>		End of LiquidityCreditTransfer1	End of LiquidityCreditTransfer
		Mandatory	Validation: [1..1]
</LqdyCdtTrf>		End message name LiquidityCreditTransfer	End message name LiquidityCreditTransfer
		Mandatory	Validation: [1..1]

Error Codes:

Order	Error code				Error Text / Validation/ Remark
	SSP	Y-copy	V-shape	XML	
1	X41			1401	Error Text: No permission. RBAC User role(s) are not sufficient. Validation: RBAC role name "APPLICATE", "APPLICSTE" or "APPLICBTE" are required Remark: checked by ICM / Receipt
2	X44			1404	Error Text: If "non repudiation of emission" is mandatory, the NRE indicator flag has to be present Validation: If non-repudiaton processing is mandatory, the tag <SwInt:NRIndicator>TRUE</SwInt:NRIndicator> has to be present. Remark: Receipt /checked by ICM
3	868	C8	XI19	2868	Error Text: Invalid sending/receiving BIC Validation: Remark:
4	862	C2	TM01	2862	Error Text: Request out of cut-off time Validation: Remark:
5	861	C1	RF01	2861	Error Text: Double input Validation: Remark:
6	H13			H013	Error Text: Requested field missing in input Validation: Remark:
7	H09			H009	Error Text: Parameter logical error <.> Validation: Remark:
8	H08			H008	Error Text: Requestor unknown Validation: Remark:
9	H07	M7		H007	Error Text: Account not open Validation: Remark:
10	H04	M4	XT16	H004	Error Text: Operation not allowed (e.g. cross border) Validation: Remark:
11	H01		XI01	H001	Error Text: Sender not allowed Validation: Remark:
12	858	B8	XI00	2858	Error Text: Mandatory field not found Validation:

Order	Error code				Error Text / Validation/ Remark
	SSP	Y-copy	V-shape	XML	

Remark:

LiquidityCreditTransfer_SF_1

Scope: Overnight deposit setting up: liquidity transfer from the HAM account (debtor) to the overnight deposit account (creditor) of the same participant.

Message name for LiquidityCreditTransfer	<LqdyCdtTrf>
Message Header	<MsgHdr>
Message Identification	<MsgId>SFCDEFGHIJKLMNOPQRST123456789012345</MsgId>
End of Message Header	</MsgHdr>
LiquidityCreditTransfer1	<LqdyCdtTrf>
CreditorAccount	<CdtrAcct>
Identification	<Id>
GenericAccountIdentification	<Othr>
AccountIdentification	<Id>BBBBITRRXXX</Id>
End of GenericAccountIdentification	</Othr>
End Identification	</Id>
CashAccountType	<Tp>
ExternalCashAccountTypeCode	<Cd>ONDP</Cd>
End of CashAccountType	</Tp>
EndCreditorAccount	</CdtrAcct>
Amount	<TrfdAmt>
Amount without currency	<AmtWthtCcy>1234.56</AmtWthtCcy>
End of Transferred Amount	</TrfdAmt>
DebtorAccount	<DbtrAcct>
Identification	<Id>
GenericAccountIdentification	<Othr>
AccountIdentification	<Id>BROMITRRXXX</Id>
End of GenericAccountIdentification	</Othr>
End Identification	</Id>
EndDebtorAccount	</DbtrAcct>
End of LiquidityCreditTransfer1	</LqdyCdtTrf>
End message name LiquidityCreditTransfer	</LqdyCdtTrf>

LiquidityCreditTransfer_SF_2

Scope: Marginal lending setting up: liquidity transfer from the marginal lending account (debtor) to the PM account (creditor) of the same participant. The requestor is the NCB of the participant.

Message name for LiquidityCreditTransfer	<LqdyCdtTrf>
Message Header	<MsgHdr>
Message Identification	<MsgId>SFCDEFGHIJKLMNOPQRST123456789012345</MsgId>
End of Message Header	</MsgHdr>
LiquidityCreditTransfer1	<LqdyCdtTrf>
CreditorAccount	<CdtrAcct>
Identification	<Id>
GenericAccountIdentification	<Othr>
AccountIdentification	<Id>BBBBITRRXXX</Id>
End of GenericAccountIdentification	</Othr>
End Identification	</Id>
EndCreditorAccount	</CdtrAcct>
Amount	<TrfdAmt>
Amount without currency	<AmtWthtCcy>1234.56</AmtWthtCcy>
End of Transferred Amount	</TrfdAmt>
DebtorAccount	<DbtrAcct>
Identification	<Id>
GenericAccountIdentification	<Othr>
AccountIdentification	<Id>BBBBITRRXXX</Id>
End of GenericAccountIdentification	</Othr>
End Identification	</Id>
CashAccountType	<Tp>
ExternalCashAccountTypeCode	<Cd>MGLD</Cd>
End of CashAccountType	</Tp>
EndDebtorAccount	</DbtrAcct>
End of LiquidityCreditTransfer1	</LqdyCdtTrf>
End message name LiquidityCreditTransfer	</LqdyCdtTrf>

6. 8. 4 ReturnAccount

Cash Management Standard

ReturnAccount_SF

Scope: The Return Account Message is used to return information about the balance of the marginal lending account and of the overnight deposit account. The connected request is performed through a Get Account Message.

<camt.004.001.xx>

Structure:

Message name of ReturnAccount	<RtrAcct>
Message Header	<MsgHdr>
Message Identification	<MsgId></MsgId>
Original Business Query	<OrgnBizQry>
Message Identification	<MsgId></MsgId>
End of Original Business Query	</OrgnBizQry>
End of Message Header	</MsgHdr>
AccountOrOperationalErrorChoice	<RptOrErr>
Choice	xorAcctRptOprlErr
AccountReport	<AcctRpt>
Account Identification	<AcctId>
GenericAccountIdentification	<Othr>
AccountIdentification	<Id></Id>
End of GenericAccountIdentification	</Othr>
End of Account Identification	</AcctId>
Account information (or business error)	<AcctOrErr>
Account Identification	<Acct>
CashAccountType	<Tp>
ExternalCashAccountTypeCode	<Cd></Cd>
End of CashAccountType	</Tp>
MultilateralBalance	<MulBal>
Amount	<Amt></Amt>
Credit or debit indicator	<CdtDbtInd></CdtDbtInd>
BalanceTypeCode	<Tp>
BalanceTypeCode	<Cd></Cd>
End of SystemEventTypeChoice	</Tp>
Value Date	<ValDt>
Date Time	<DtTm></DtTm>
End Value Date	</ValDt>
End of MultilateralBalance	</MulBal>
End of Account	</Acct>
End of Account or Business Error	</AcctOrErr>
End of AccountReport	</AcctRpt>
Operational Error	<OprlErr>
Error handling	<Err>
Proprietary error code	<Prtry></Prtry>
End error handling	</Err>
Description	<Desc></Desc>
End of Operational Error	</OprlErr>
End of Choice	/xorAcctRptOprlErr
End of AccountOrOperationalErrorChoice	</RptOrErr>
End of Message name of ReturnAccount	</RtrAcct>

Attributes:

name of attribute	format	short description	description
<RtrAcct>		Message name of ReturnAccount Mandatory	Message name of ReturnAccount Validation: [1..1]
<MsgHdr>		Message Header Mandatory	Set of characteristics specific to the message Validation: [1..1]
<MsgId>-</MsgId>	35x	Message Identification Mandatory	Message Identification String of characters that uniquely identifies a message at senders side. Validation: [1..1]
<OrgnlBizQry>		Original Business Query Mandatory	Original Business Query, reference to the query Validation: [1..1]
<MsgId>-</MsgId>	35x	Message Identification Optional	Message Identification Message identification of the connected request . Validation: [0..1]
</OrgnlBizQry>		End of Original Business Query Mandatory	End of Original Business Query, reference to the query Validation: [1..1]
</MsgHdr>		End of Message Header Mandatory	Validation: [1..1]
<RptOrErr>		AccountOrOperationalError Choice Mandatory	Validation: [1..1]
xorAcctRptOprlErr		Choice Mandatory	Choice between AccountReport and OperationalError Validation: [1..1]
<AcctRpt>		AccountReport Mandatory	Validation: [1..n]
<AcctId>		Account Identification Mandatory	Account Identification Validation: [1..1]
<Othr>		GenericAccountIdentificatio n Mandatory	GenericAccountIdentification Validation: [1..1]
<Id>-</Id>	BICFI	AccountIdentification Mandatory	AccountIdentification BIC of the participant to whom data are referred. Validation:

name of attribute	format	short description	description
			[1..1]
</Othr>		End of GenericAccountIdentification Mandatory	End of GenericAccountIdentification Validation: [1..1]
</AcctId>		End of Account Identification Mandatory	Validation: [1..1]
<AcctOrErr>		Account information (or business error) Mandatory	Validation: [1..1]
<Acct>		Account Identification Mandatory	Choice amongst Acct and BizErr Validation: [1..1]
<Tp>		CashAccountType Mandatory	CashAccountType Validation: [1..1]
<Cd>-</Cd>		ExternalCashAccountType Code Optional	ExternalCashAccountTypeCode SSP restricted code list: CACC = Current Account used to post debits and credits when no specific account has been nominated SACC = Settlement Account used to post debit and credit entries, as a result of transactions cleared and settled through a specific clearing and settlement system. Account Type. It will be: "ONDP"(Overnight Deposit) or "MGLD" Marginal Lending). Validation: [0..1]
</Tp>		End of CashAccountType Mandatory	End of CashAccountType Validation: [1..1]
<MulBal>		MultilateralBalance Optional	Validation: [0..n]
<Amt>-</Amt>	18d	Amount Mandatory	Amount of the current balance . Validation: [1..1]
<CdtDbtInd>-</CdtDbtInd>	4!a	Credit or debit indicator Mandatory	Debit credit indicator. It will be:"CRDT" (credit) or "DBIT" (debit). Validation: [1..1]
<Tp>		BalanceTypeCode	Type ADJT Adjustment

name of attribute	format	short description	description
			<p>Balance to be held in the settlement account in order to comply with the average reserve due, in the event that the bank's balance is equal to the reserve due during the remaining days of the maintenance period.</p>
			<p>AVLB Available Balance of money or securities that is at the disposal of the account owner on the date specified.</p>
			<p>BLCK Blocked Balance representing the regulatory reserve that a financial institution must have with the account servicing institution, eg, the minimum credit balance a financial institution is to keep with its Central Bank for mandatory reserve purposes. In some countries, a blocked balance is known as a 'reserve' balance.</p>
			<p>BOOK Book Balance that is registered in the books of the account servicer.</p>
			<p>CLSG Closing Balance of the account at the end of the account servicer's business day. It is the sum of the opening balance at the beginning of the day and all entries booked to the account during the account servicer's business day.</p>
			<p>CRDT Credit Balance representing the sum of all credit entries booked to an account.</p>
			<p>CRRT Current Balance of the account at a precise moment in time.</p>
			<p>DBIT Debit Balance representing the sum of all debit entries booked to an account.</p>
			<p>DLOD DaylightOverdraft Balance representing the intra day overdraft granted by the Central Bank to financial institutions participating in a RTGS system. This balance may vary over time and shall be offset at the end of the day.</p>
			<p>EAST EligibleAssets Balance representing the potential loan a Central Bank would make in cash if the collateral is pledged, eg, securities available and eligible as collateral with the Central Bank.</p>
			<p>INTM Interim Balance calculated in the course of the account servicer's business day, at the time specified, and subject to further changes during the business day. The interim balance is calculated on the basis of booked credit and debit items during the calculation time/period specified.</p>
			<p>LRLD LimitRelated Balance of a specific limit value, eg, a bilateral balance is calculated in relation to a given bilateral limit.</p>
			<p>LTSF LiquidityTransfer Balance composed of the sum of all liquidity transfers made to or from an account.</p>
			<p>OPNG Opening Book balance of the account at the beginning of the account servicer's business day. It always equals the closing book balance from the previous business day. Note: the available balance at the beginning of the account servicer's business day may be different from the closing book balance from the previous business day.</p>
			<p>PDNG Pending Balance of securities pending delivery, eg, orders to sell securities have been executed but settlement of the open transactions has not been confirmed.</p>

name of attribute	format	short description	description
			<p>PRAV ProgressiveAverage Average of the daily balances on the account used to fulfil the reserve requirements calculated from the beginning of the maintenance period.</p> <p>PYMT Payment Balance representing the sum of entries as a result of payments processing. Entries relating to fees, interest, or other movements not a result of payments sent or received by the account owner are not included.</p> <p>XCRD ExpectedCredit Balance, composed of booked entries and pending items known at the time of calculation, which projects the end of day credit balance if everything books to the account and no other credit entry is posted.</p> <p>XDBT ExpectedDebit Balance, composed of booked entries and pending items known at the time of calculation, which projects the end of day debit balance if everything books to the account and no other debit entry is posted.</p> <p>XPCD Expected Balance, composed of booked entries and pending items known at the time of calculation , which projects the end of day balance if everything is booked on the account and no other entry is posted.</p> <p>Balance type. It can be: "OPNG" (opening balance) or "CRRT" (current balance). Special case: if the account is no more active, but a balance greater than zero is still present, it will be "CLSG " (closing balance).</p> <p>Mandatory</p> <p>Validation: [1..1]</p>
<Cd>		BalanceTypeCode	<p>Specifies the nature of the balance, eg, opening balance.</p> <p>ADJT= Adjustment Average balance to be held in the settlement account at the end of each day in order to fulfil the reserve due. The approximation will be always made rounding up.</p> <p>AVLB = Available Balance of money or securities that is at the disposal of the account owner on the date specified.</p> <p>BLCK = Blocked Balance representing the regulatory reserve that a financial institution must have with the account servicing institution, eg, the minimum credit balance a financial institution is to keep with ist Central Bank for mandatory reserve purposes. In some countries, a blocked balance is known as a 'reserve' balance.</p> <p>BOOK = Book Balance that is registered in the books of the account servicer.</p> <p>CLSG = Closing Balance of the account at the end of the account servicer's business day. It is the sum of the opening balance at the beginning of the day and all entries booked to the account during the account servicer's business day.</p> <p>CRDT = Credit Balance representing the sum of all credit entries booked to an account.</p> <p>CRRT = Current Balance of the account at a precise moment in time.</p> <p>DBIT = Debit Balance representing the sum of all debit entries booked to an account.</p> <p>DLOD = DaylightOverdraft Balance representing the intra day overdraft granted by</p>

name of attribute	format	short description	description
			<p>the Central Bank to financial institutions participating in a RTGS system. This balance may vary over time and shall be offset at the end of the day.</p> <p>EAST = EligibleAssets Balance representing the potential loan a Central Bank would make in cash if the collateral is pledged, eg, securities available and eligible as collateral with the Central Bank.</p> <p>INTM = Interim Balance calculated in the course of the account servicer's business day, at the time specified, and subject to further changes during the business day. The interim balance is calculated on the basis of booked credit and debit items during the calculation time/period specified.</p> <p>LRLD = LimitRelated Balance of a specific limit value, eg, a bilateral balance is calculated in relation to a given bilateral limit.</p> <p>LTSF= LiquidityTransfer Balance composed of the sum of all liquidity transfers made to or from an account.</p> <p>OPNG = Opening Book balance of the account at the beginning of the account servicer's business day. It always equals the closing book balance from the previous business day. Note: the available balance at the beginning of the account servicer's business day may be different from the closing book balance from the previous business day.</p> <p>PDNG = Pending Balance of securities pending delivery, eg, orders to sell securities have been executed but settlement of the open transactions has not been confirmed.</p> <p>PRAV = ProgressiveAverage Average of the daily balances on the account used to fulfil the reserve requirements calculated from the beginning of the maintenance period.</p> <p>PYMT = Payment Balance representing the sum of entries as a result of payments processing. Entries relating to fees, interest, or other movements not a result of payments sent or received by the account owner are not included.</p> <p>XCRD = ExpectedCredit Balance, composed of booked entries and pending items known at the time of calculation, which projects the end of day credit balance if everything books to the account and no other credit entry is posted.</p> <p>XDBT = ExpectedDebit Balance, composed of booked entries and pending items known at the time of calculation, which projects the end of day debit balance if everything books to the account and no other debit entry is posted.</p> <p>XPCD = Expected Balance, composed of booked entries and pending items known at the time of calculation, which projects the end of day balance if everything is booked on the account and no other entry is posted.</p> <p>*****NOTE = Noted Balance Balance representing the amount that a financial institution has set aside for a specific reason and which is therefore not available</p> <p>Balance Type. It will be: "CRRT"(current balance). Special case: if the account is no more active, but a balance different than zero is still present, it will be "CLSG" " (closing balance).</p>
		Mandatory	<p>Validation: [1..1]</p>

name of attribute	format	short description	description
</Tp>		End of SystemEventTypeChoice Mandatory	Validation: [1..1]
<ValDt>		Value Date Optional	Validation: [0..1]
<DtTm>-</DtTm>	ISODateTime	Date Time Mandatory	Date and time of the response (with UTC shift) (yyyy-mm-ddThh:mm:ss+ii:nn). Validation: [1..1]
</ValDt>		End Value Date Optional	Validation: [0..1]
</MulBal>		End of MultilateralBalance Mandatory	Validation: [0..n]
</Acct>		End of Account Mandatory	Validation: [1..1]
</AcctOrErr>		End of Account or Business Error Mandatory	Validation: [1..1]
</AcctRpt>		End of AccountReport Mandatory	Validation: [1..n]
<OprlErr>		Operational Error Mandatory	Validation: [1..1]
<Err>		Error handling Mandatory	Validation: [1..1]
<Prtry>-</Prtry>	4x	Proprietary error code Mandatory	Specification of the error, in free format. Validation: [1..1]
</Err>		End error handling Mandatory	Validation: [1..1]
<Desc>-</Desc>	140x	Description Optional	Error description Validation: [0..1]
</OprlErr>		End of Operational Error Mandatory	End of Operational Error Validation:

name of attribute	format	short description	description
/xorAcctRptOpriErr		End of Choice Mandatory	[1..1] Validation: [1..1]
</RptOrErr>		End of AccountOrOperationalError Choice Mandatory	Validation: [1..1]
</RtrAcct>		End of Messagname of ReturnAccount Mandatory	end of Messagname of ReturnAccount Validation: [1..1]

Error Codes:

ReturnAccount_SF_1

Scope: A response to a request of information about the overnight deposit account balance. (see example 1 of the Get Account Message) account holder.

Message name of ReturnAccount	<RtrAcct>
Message Header	<MsgHdr>
Message Identification	<MsgId>SFCDEFGHIJKLMNOPQRST123456789012345</MsgId>
Original Business Query	<OrgnlBizQry>
Message Identification	<MsgId>ABCDEFGHIJKLMNQRST123456789012345</MsgId>
End of Original Business Query	</OrgnlBizQry>
End of Message Header	</MsgHdr>
AccountOrOperationalErrorChoice	<RptOrErr>
AccountReport	<AcctRpt>
Account Identification	<AcctId>
GenericAccountIdentification	<Othr>
AccountIdentification	<Id>BBBBITRRXXX</Id>
End of GenericAccountIdentification	</Othr>
End of Account Identification	</AcctId>
Account information (or business error)	<AcctOrErr>
Account Identification	<Acct>
CashAccountType	<Tp>
ExternalCashAccountTypeCode	<Cd>ONDP</Cd>
End of CashAccountType	</Tp>
MultilateralBalance	<MulBal>
Amount	<Amt>1234.56</Amt>
Credit or debit indicator	<CdtDbtInd>CRDT</CdtDbtInd>
BalanceTypeCode	<Tp>
BalanceTypeCode	<Cd>CRRT</Cd>
End of SystemEventTypeChoice	</Tp>
Value Date	<ValDt>
Date Time	<DtTm>2007-09-12T15:29:00+00:00</DtTm>
End Value Date	</ValDt>
End of MultilateralBalance	</MulBal>
End of Account	</Acct>
End of Account or Business Error	</AcctOrErr>
End of AccountReport	</AcctRpt>
End of AccountOrOperationalErrorChoice	</RptOrErr>
End of Message name of ReturnAccount	</RtrAcct>

ReturnAccount_SF_2

Scope: A response to a request of information about the marginal lending account balance (see example 2 of the Get Account Message).

Messagename of ReturnAccount	<RtrAcct>
Message Header	<MsgHdr>
Message Identification	<MsgId>ABCDEFGHIJKLMNQRST123456789012345</MsgId>
Original Business Query	<OrgnlBizQry>
Message Identification	<MsgId>SFCDEFGHIJKLMNQRST123456789012345</MsgId>
End of Original Business Query	</OrgnlBizQry>
End of Message Header	</MsgHdr>
AccountOrOperationalErrorChoice	<RptOrErr>
AccountReport	<AcctRpt>
Account Identification	<AcctId>
GenericAccountIdentification	<Othr>
AccountIdentification	<Id>BBBBITRRXXX</Id>
End of GenericAccountIdentification	</Othr>
End of Account Identification	</AcctId>
Account information (or business error)	<AcctOrErr>
Account Identification	<Acct>
CashAccountType	<Tp>
ExternalCashAccountTypeCode	<Cd>MGLD</Cd>
End of CashAccountType	</Tp>
MultilateralBalance	<MulBal>
Amount	<Amt>1234.56</Amt>
Credit or debit indicator	<CdtDbtInd>DBIT</CdtDbtInd>
BalanceTypeCode	<Tp>
BalanceTypeCode	<Cd>CRRT</Cd>
End of SystemEventTypeChoice	</Tp>
Value Date	<ValDt>
Date Time	<DtTm>2007-09-12T15:29:00+00:00</DtTm>
End Value Date	</ValDt>
End of MultilateralBalance	</MulBal>
End of Account	</Acct>
End of Account or Business Error	</AcctOrErr>
End of AccountReport	</AcctRpt>
End of AccountOrOperationalErrorChoice	</RptOrErr>
End of Messagename of ReturnAccount	</RtrAcct>

6. 8. 5 ReturnAccount (Push) (for CBs only)

Cash Management Standard

ReturnAccount (Push)_SF

Scope: The Return Account Message in push mode (sent via InterAct) is used in the following 3 cases:

CASE 1) to inform a Central Bank about the spillover (intraday credit not returned at the end of the business day) of a participant not allowed to have access to the marginal lending facility;

CASE 2) to inform the Collateral Manager about the setting up of the Automatic Marginal Lending;

CASE 3) to inform the Collateral Manager about the refunding of the marginal lending (both in case of marginal lending "on request" and "automatic") or about the marginal lending reverse transaction (initiated by the SSP Operational Team).

<camt.004.001.xx>

Structure:

Message Type	<RtrAcct>
Message Identification	<Msgld>
Message business identification	<Id></Id>
Message Identification	<Msgld>
BusinessReport	<BizRpt>
AccountReport	<AcctRpt>
Account Identification	<AcctId>
Simple Identification Information	<DmstAcct>
Message business identification	<Id></Id>
End of simple Identification Information	</DmstAcct>
End of Account Identification	</AcctId>
Account Identification	<Acct>
Type	<Tp></Tp>
MultilateralBalance	<MulBal>
Amount	<Amt></Amt>
Credit or debit indicator	<CdtDbtInd></CdtDbtInd>
Type	<Tp></Tp>
Value Date	<ValDt>
Date Time	<DtTm></DtTm>
End Value Date	</ValDt>
End of MultilateralBalance	</MulBal>
End of Account	</Acct>
End of AccountReport	</AcctRpt>
End of BusinessReport	</BizRpt>
End of Message Type	</RtrAcct>

Attributes:

name of attribute	format	short description	description
<RtrAcct>		Message Type Mandatory	Validation: [1..1]
<Msgld>		Message Identification Mandatory	Message business identification Unique and unambiguous identifier for a message, as assigned by the Sender. This unique identifier can be used for cross-referencing purposes in subsequent messages. Validation: [1..1]
<Id>-</Id>	35x	Message business identification Mandatory	String of characters that uniquely identifies a message at senders side. Validation: [1..1]
<Msgld>		Message Identification Mandatory	Message business identification Unique and unambiguous identifier for a message, as assigned by the Sender. This unique identifier can be used for cross-referencing purposes in subsequent messages. Validation: [1..1]
<BizRpt>		BusinessReport Mandatory	Validation: [1..1]
<AcctRpt>		AccountReport Mandatory	Validation: [1..n]
<Acctld>		Account Identification Mandatory	Account Identification Validation: [1..1]
<DmstAcct>		Simple Identification Information Mandatory	Simple Identification Information Validation: [1..1]
<Id>-</Id>	35x	Message business identification Mandatory	BIC of the participant to whom data are referred. Validation: [1..1]
</DmstAcct>		End of simple Identification Information Mandatory	Validation: [1..1]
</Acctld>		End of Account Identification Mandatory	Validation: [1..1]
<Acct>		Account Identification	

name of attribute	format	short description	description
		Mandatory	Validation: [1..1]
<Tp>-</Tp>	35x	Type	Account Type. It will be: "SACC" (RTGS Account) for CASE 1 (information about spillover sent to the NCB); it will be "MGLD" (Marginal Lending) for CASE 2 and CASE 3 (information sent to the Collateral Manager about the refunding of the marginal lending, the marginal lending reverse transaction or about the automatic marginal lending setting up).
		Optional	Validation: [0..1]
<MulBal>		MultilateralBalance	
		Optional	Validation: [0..n]
<Amt>-</Amt>	18d	Amount	Amount . The amount will refer to the spillover (CASE 1) or to the current balance of the marginal lending account (CASE 2 and CASE 3).
		Mandatory	Validation: [1..1]
<CdtDbtInd>-</CdtDbtInd>	4!a	Credit or debit indicator	Debit credit indicator It will be: "CRDT" (credit) or "DBIT" (debit).
		Mandatory	Validation: [1..1]
<Tp>-</Tp>	35x	Type	Balance Type. It will be: "CRRT" (current balance).
		Optional	Validation: [0..1]
<ValDt>		Value Date	This section specifies when (date and time) the Return Account Message is sent.
		Optional	Validation: [0..1]
<DtTm>-</DtTm>	ISODateTime	Date Time	Date and time (with UTC shift) (yyyy-mm-ddThh:mm:ss+ii:nn).
		Mandatory	Validation: [1..1]
</ValDt>		End Value Date	
		Optional	Validation: [0..1]
</MulBal>		End of MultilateralBalance	
		Optional	Validation: [0..n]
</Acct>		End of Account	
		Mandatory	Validation: [1..1]
</AcctRpt>		End of AccountReport	
		Mandatory	Validation: [1..n]
</BizRpt>		End of BusinessReport	

name of attribute	format	short description	description
		Mandatory	Validation: [1..1]
</RtrAcct>		End of Message Type Mandatory	Validation: [1..1]

Error Codes:

ReturnAccount (Push)_SF_1

Scope: Send to a Central Bank information about the spillover of a participant (CASE 1).

Message Type	<RtrAcct>
Message Identification	<MsgId>
Message business identification	<Id>SFCDEFGHIJKLMNOPQRST123456789012345</Id>
Message Identification	</MsgId>
BusinessReport	<BizRpt>
AccountReport	<AcctRpt>
Account Identification	<AcctId>
Simple Identification Information	<DmstAcct>
Message business identification	<Id>BBBBITRRXX</Id>
End of simple Identification Information	</DmstAcct>
End of Account Identification	</AcctId>
Account Identification	<Acct>
Type	<Tp>SACC</Tp>
MultilateralBalance	<MulBal>
Amount	<Amt>1234.56</Amt>
Credit or debit indicator	<CdtDbtInd>DBIT</CdtDbtInd>
Type	<Tp>CRRT</Tp>
Value Date	<ValDt>
Date Time	<DtTm>2007-09-12T18:33:00+00:00</DtTm>
End Value Date	</ValDt>
End of MultilateralBalance	</MulBal>
End of Account	</Acct>
End of AccountReport	</AcctRpt>
End of BusinessReport	</BizRpt>
End of Message Type	</RtrAcct>

ReturnAccount (Push)_SF_2

Scope: Send to the Collateral Manager information about the Automatic Marginal Lending setting up (CASE 2).

Message Type	<RtrAcct>
Message Identification	<MsgId>
Message business identification	<Id>SFCDEFGHIJKLMNOPQRST123456789012345</Id>
Message Identification	</MsgId>
BusinessReport	<BizRpt>
AccountReport	<AcctRpt>
Account Identification	<AcctId>
Simple Identification Information	<DmstAcct>
Message business identification	<Id>DDDDITRRXXX</Id>
End of simple Identification Information	</DmstAcct>
End of Account Identification	</AcctId>
Account Identification	<Acct>
Type	<Tp>MGLD</Tp>
MultilateralBalance	<MulBal>
Amount	<Amt>5234.16</Amt>
Credit or debit indicator	<CdtDbtInd>DBIT</CdtDbtInd>
Type	<Tp>CRRT</Tp>
Value Date	<ValDt>
Date Time	<DtTm>2007-09-13T18:35:12+00:00</DtTm>
End Value Date	</ValDt>
End of MultilateralBalance	</MulBal>
End of Account	</Acct>
End of AccountReport	</AcctRpt>
End of BusinessReport	</BizRpt>
End of Message Type	</RtrAcct>

ReturnAccount (Push)_SF_3

Scope: Send to the Collateral Manager information about the refunding of the marginal lending or the marginal lending reverse transaction (CASE 3).

Message Type	<RtrAcct>
Message Identification	<MsgId>
Message business identification	<Id>SFCDEFGHIJKLMNOPQRST123456789012345</Id>
Message Identification	</MsgId>
BusinessReport	<BizRpt>
AccountReport	<AcctRpt>
Account Identification	<AcctId>
Simple Identification Information	<DmstAcct>
Message business identification	<Id>DDDDITRRXXX</Id>
End of simple Identification Information	</DmstAcct>
End of Account Identification	</AcctId>
Account Identification	<Acct>
Type	<Tp>MGLD</Tp>
MultilateralBalance	<MulBal>
Amount	<Amt>0.00</Amt>
Credit or debit indicator	<CdtDbtInd>CRDT</CdtDbtInd>
Type	<Tp>CRRT</Tp>
Value Date	<ValDt>
Date Time	<DtTm>2007-09-13T19:41:08+00:00</DtTm>
End Value Date	</ValDt>
End of MultilateralBalance	</MulBal>
End of Account	</Acct>
End of AccountReport	</AcctRpt>
End of BusinessReport	</BizRpt>
End of Message Type	</RtrAcct>

6. 8. 6 ReturnTransaction

Cash Management Standard

ReturnTransaction_SF

Scope: The Return Transaction Message is used to return information about Standing Facilities transactions. The connected request is performed through a Get Transaction Message. If the query type "CHNG", "MODF" or "DELD" is used in the GetTransaction message, only modified, deleted or new items between two similar queries will be returned.

<camt.006.001.xx>

Structure:

MessageName for Return Transaction	<RtrTx>
Message Header	<MsgHdr>
Message Identification	<MsgId></MsgId>
Original Business Query	<OrgnlBizQry>
Message Identification	<MsgId></MsgId>
End of Original Business Query	</OrgnlBizQry>
Name of former Query	<QryNm></QryNm>
End of Message Header	</MsgHdr>
BusinessReportOrErrorChoice	<RptOrErr>
Choice	xorBizRptOprlErr
BusinessReport	<BizRpt>
TransactionReport	<TxRpt>
PaymentIdentification	<PmtId>
ProprietaryId	<PrtryId></PrtryId>
EndPaymentIdentification	</PmtId>
TransactionOrErrorChoice	<TxOrErr>
Transaction	<Tx>
PaymentTo	<PmtTo>
Member Identification	<Mmbld>
Financial Institution Identification	<FinInstnId>
BICFIIdentifier	<BICFI></BICFI>
End of Financial Institution Identification	</FinInstnId>
End Member Identification	</Mmbld>
End PaymentTo	</PmtTo>
Payment From	<PmtFr>
Member Identification	<Mmbld>
Financial Institution Identification	<FinInstnId>
BICFIIdentifier	<BICFI></BICFI>
End of Financial Institution Identification	</FinInstnId>
End Member Identification	</Mmbld>
End Payment From	</PmtFr>
Credit or debit indicator	<CdtDbtInd></CdtDbtInd>
Payment	<Pmt>
RequestedExecutionDate	<ReqdExctnDt>
Date Time	<DtTm></DtTm>
End of RequestedExecutionDate	</ReqdExctnDt>
PaymentStatus	<Sts>
PaymentStatusCode	<Cd>
Choice	xorPdgStsFnlSts
Pending	<Pdg></Pdg>
Final	<Fnl></Fnl>
End of choice	/xorPdgStsFnlSts
End of PaymentStatusCode	</Cd>

DateTime	<DtTm>
Date Time	<DtTm></DtTm>
End of DateTime	</DtTm>
Reason	<Rsn>
ProprietaryStatusJustification	<PrtryRjctn>
Proprietary Status Reason	<PrtryStsRsn></PrtryStsRsn>
Reason	<Rsn></Rsn>
End of ProprietaryStatusJustification	</PrtryRjctn>
End of Reason	</Rsn>
End of PaymentStatus	</Sts>
Instructed Amount	<InstdAmt>
Amount without currency	<AmtWthtCcy></AmtWthtCcy>
End Instructed Amount	</InstdAmt>
ProcessingValidityTime	<PrcgVldtyTm>
From Date Time	<FrDtTm></FrDtTm>
End Processing Validity Time	</PrcgVldtyTm>
Type	<Tp>
Payment type code	<Cd></Cd>
End of Type	</Tp>
TransactionIdentification	<TxId></TxId>
Value date	<IntrBkSttlmDt></IntrBkSttlmDt>
Parties	<Pties>
Creditor	<Cdtr>
Financial Institution Identification	<FinInstnId>
BICFIIdentifier	<BICFI></BICFI>
End of Financial Institution Identification	</FinInstnId>
End of Creditor	</Cdtr>
End of Parties	</Pties>
End Payment	</Pmt>
End ofTransaction	</Tx>
End of TransactionOrErrorChoice	</TxOrErr>
End Transaction Report	</TxRpt>
End of BusinessReport	</BizRpt>
Operational Error	<OprlErr>
Error handling	<Err>
Proprietary error code	<Prtry></Prtry>
End error handling	</Err>
Description	<Desc></Desc>
End of Operational Error	</OprlErr>
End of choice	/xorBizRptOprErr
End of BusinessReportOrErrorChoice	</RptOrErr>
End messagename ReturnTransaction	</RtrTx>

Attributes:

name of attribute	format	short description	description
<RtrTx>		Message name for Return Transaction Mandatory	Message name for Return Transaction Validation: [1..1]
<MsgHdr>		Message Header Mandatory	Set of characteristics specific to the message Validation: [1..1]
<MsgId>-</MsgId>	35x	Message Identification Mandatory	Message Identification String of characters that uniquely identifies a message at senders side. Validation: [1..1]
<OrgnlBizQry>		Original Business Query Mandatory	Original Business Query, reference to the query Validation: [1..1]
<MsgId>-</MsgId>	35x	Message Identification Mandatory	Message Identification Message identification of the connected request . Validation: [1..1]
</OrgnlBizQry>		End of Original Business Query Mandatory	End of Original Business Query, reference to the query Validation: [1..1]
<QryNm>-</QryNm>	35x	Name of former Query Mandatory	Recalls the criteria (search and return criteria) defined in a preceding query [0..1] Reference for the delta set retrieval. Value is generated by ICM. Validation: [1..1]
</MsgHdr>		End of Message Header Mandatory	Validation: [1..1]
<RptOrErr>		BusinessReportOrErrorChoice Mandatory	Validation: [1..1]
xorBizRptOprlErr		Choice Mandatory	Validation: [1..1]
<BizRpt>		BusinessReport Mandatory	Validation: [1..1]
<TxRpt>		TransactionReport Mandatory	Validation: [1..n]

name of attribute	format	short description	description
<PmtId>		PaymentIdentification	Set of elements to provide further means of referencing a payment transaction
		Mandatory	Validation: [1..1]
<PrtryId>-</PrtryId>	43x	ProprietaryId	ProprietaryId Internal transfer identifier. Unique and unambiguous identifier of a transaction, generated by SFM (Standing Facilities Module). Digits from 10 to 20 of the internal transfer identifier identify the BIC of the sender of the transaction .
		Mandatory	Validation: [1..1]
</PmtId>		EndPaymentIdentification	End of Set of elements to reference a payment transaction
		Mandatory	Validation: [1..1]
<TxOrErr>		TransactionOrErrorChoice	
		Mandatory	Validation: [1..1]
<Tx>		Transaction	
		Mandatory	Validation: [1..1]
<PmtTo>		PaymentTo	
		Optional	Validation: [0..1]
<Mmbld>		Member Identification	
		Optional	Validation: [0..1]
<FinInstnId>		Financial Institution Identification	Financial Institution Identification
		Mandatory	Validation: [1..1]
<BICFI>-</BICFI>	4!a2!a2!c3!c	BICFIIdentifier	BICFIIdentifier BIC of the participant to whom transactions are referred (creditor).
		Mandatory	Validation: [1..1]
</FinInstnId>		End of Financial Institution Identification	End of Financial Institution Identification
		Mandatory	Validation: [1..1]
</Mmbld>		End Member Identification	
		Optional	Validation: [0..1]
</PmtTo>		End PaymentTo	
		Optional	Validation: [0..1]
<PmtFr>		Payment From	

name of attribute	format	short description	description
		Optional	Validation: [0..1]
<MmblId>		Member Identification Optional	Validation: [0..1]
<FinInstnId>		Financial Institution Identification Mandatory	Financial Institution Identification Validation: [1..1]
<BICFI>-</BICFI>	4!a2!a2!c3!c	BICFIIdentifier Mandatory	BICFIIdentifier BIC of the participant to whom transactions are referred (debtor). Validation: [1..1]
</FinInstnId>		End of Financial Institution Identification Mandatory	End of Financial Institution Identification Validation: [1..1]
</MmblId>		End Member Identification Optional	Validation: [0..1]
</PmtFr>		End Payment From Optional	Validation: [0..1]
<CdtDbtInd>-</CdtDbtInd>	4!a	Credit or debit indicator Optional	Credit debit indicator. It will be: "CRDT" (credit) or "DBIT" (debit). NOTE: Credit debit indicator is always referred to the SFM part of the transaction, e.g. for overnight deposit setting up will be CRDT, while for marginal lending setting up will be DBIT. Validation: [0..1]
<Pmt>		Payment Optional	Validation: [0..1]
<ReqdExctnDt>		RequestedExecutionDate Optional	Validation: [0..1]
<DtTm>-</DtTm>	ISODateTime	Date Time Mandatory	Specifies when the transaction arrived in SFM (yyyy-mm-ddThh:mm:ss+ii:nn). Validation: [1..1]
</ReqdExctnDt>		End of RequestedExecutionDate Optional	Validation: [0..1]
<Sts>		PaymentStatus Optional	Validation: [0..1]

name of attribute	format	short description	description
<Cd>		PaymentStatusCode	
		Optional	Validation: [0..1]
xorPdgStsFnlSts		Choice	Choice amongst PdgSts or FnlSts
		Optional	Validation:
<Pdg>-</Pdg>	4!c	Pending	Pending Status Code of the payment
		Mandatory	Specifies the (pending) status of the selected transaction. It can be only "PSTL" (pending settlement). The attributes <PdgSts> and <FnlSts> are mutually exclusive. If <FnlSts> is valorised, <PdgSts> will not be valorised, and viceversa. Validation: [1..1]
<Fnl>-</Fnl>	4!c	Final	Final Status Code of the payment
		Mandatory	Specifies the (final) status of the selected transaction. It can be: "STLD" (settled) for transactions successfully processed or "RJTD" (rejected) for rejected transactions. The attributes <FnlSts> and <PdgSts> are mutually exclusive. If <FnlSts> is valorised, <PdgSts> will not be valorised, and viceversa. Validation: [1..1]
/xorPdgStsFnlSts		End of choice	
		Optional	Validation:
</Cd>		End of PaymentStatusCode	
		Optional	Validation: [0..1]
<DtTm>		DateTime	A specified date and time.
		Optional	Validation: [0..1]
<DtTm>-</DtTm>	ISODateTime	Date Time	Date and Time at which the transaction assumed its status (with UTC shift) (yyyy-mm-ddThh:mm:ss+ii:nn).
		Mandatory	Validation: [1..1]
</DtTm>		End of DateTime	
		Optional	Validation: [0..1]
<Rsn>		Reason	
		Optional	Validation: [0..1]
<PrtryRjctn>		ProprietaryStatusJustification	
		Mandatory	Validation: [1..1]
<PrtryStsRsn>-</PrtryStsRsn>	4x	Proprietary Status Reason	Error code.
		Mandatory	Validation: [1..1]

name of attribute	format	short description	description
<Rsn>-</Rsn>	256x	Reason Mandatory	Error description. Validation: [1..1]
</PrtryRjctn>		End of ProprietaryStatusJustification Mandatory	Validation: [1..1]
</Rsn>		End of Reason Optional	Validation: [0..1]
</Sts>		End of PaymentStatus Optional	Validation: [0..1]
<InstdAmt>		Instructed Amount Optional	Validation: [0..1]
<AmtWthtCcy>-</AmtWthtCcy>	18n	Amount without currency Mandatory	Amount of the transaction . Validation: [1..1]
</InstdAmt>		End Instructed Amount Optional	Validation: [0..1]
<PrcgVldtyTm>		ProcessingValidityTime Optional	This sequence is used to specify the date and the time of settlement. It will be present only if settlement already occurred. Validation: [0..1]
<FrDtTm>-</FrDtTm>	DateTime	From Date Time Mandatory	Settlement Date and Time (with UTC shift) (yyyy-mm-ddThh:mm:ss+ii:nn). Validation: [1..1]
</PrcgVldtyTm>		End Processing Validity Time Optional	Validation: [0..1]
<Tp>		Type Optional	Payment Type Validation: [0..1]
<Cd>-</Cd>	PaymentTyp e3Code	Payment type code	Payment type code SSP restricted code list: CLS Specifies the transaction type. Possible values are: "MGL" (Marginal Lending) for marginal lending setting-up, reverse transaction or refund and "OND" (Overnight Deposit) for overnight deposit setting-up, reverse transaction or refund.

name of attribute	format	short description	description
		Mandatory	Validation: [1..1]
</Tp>		End of Type	End of Payment Type
		Optional	Validation: [0..1]
<TxId>-</TxId>	35x	TransactionIdentification	Unique and unambiguous identification of a payment transaction, as assigned by the originator. The payment transaction reference is used for reconciliation or to link tasks relating to the payment transaction. Transaction identifier, i.e. TRN of the SWIFT input message (first 16 characters of <MsgId> of the input message).
		Optional	Validation: [0..1]
<IntrBkSttlmDt>-</IntrBkSttlmDt>	ISODate	Value date	Value date Settlement date (yyyy-mm-dd+ii:nn).
		Optional	Validation: [0..1]
<Pties>		Parties	PaymentTransactionParties needed for selection of Selection SWIFT FIN Fields
		Optional	Validation: [0..1]
<Cdtr>		Creditor	
		Optional	Validation: [0..1]
<FinInstnId>		Financial Institution Identification	Financial Institution Identification
		Mandatory	Validation: [1..1]
<BICFI>-</BICFI>	4!a2!a2!c3!c	BICFIIdentifier	BICFIIdentifier BIC of the creditor.
		Mandatory	Validation: [1..1]
</FinInstnId>		End of Financial Institution Identification	End of Financial Institution Identification
		Mandatory	Validation: [1..1]
</Cdtr>		End of Creditor	
		Optional	Validation: [0..1]
</Pties>		End of Parties	End Selection SWIFT FIN Fields
		Optional	Validation: [0..1]
</Pmt>		End Payment	
		Optional	Validation: [0..1]
</Tx>		End ofTransaction	
		Mandatory	Validation: [1..1]

name of attribute	format	short description	description
</TxOrErr>		End of TransactionOrErrorChoice Mandatory	Validation: [1..1]
</TxRpt>		End Transaction Report Mandatory	Validation: [1..n]
</BizRpt>		End of BusinessReport Mandatory	Validation: [1..1]
<OprlErr>		Operational Error Mandatory	Validation: [1..1]
<Err>		Error handling Mandatory	Validation: [1..1]
<Prtry>-</Prtry>	4x	Proprietary error code Mandatory	Specification of the error, in free format. Validation: [1..1]
</Err>		End error handling Mandatory	Validation: [1..1]
<Desc>-</Desc>	140x	Description Optional	Error description Validation: [0..1]
</OprlErr>		End of Operational Error Mandatory	End of Operational Error Validation: [1..1]
/xorBizRptOprlErr		End of choice Mandatory	Validation: [1..1]
</RptOrErr>		End of BusinessReportOrErrorChoice Mandatory	Validation: [1..1]
</RtrTx>		End messagename ReturnTransaction Mandatory	Validation: [1..1]

Error Codes:

ReturnTransaction_SF_1

Scope: Response to a request of information about standing facilities transactions of a participant (see examples 1 and 2 of Get Transaction).

MessageName for Return Transaction	<RtrTx>
Message Header	<MsgHdr>
Message Identification	<MsgId>AACDEFGHIJKLMNOPQRST123456789012345</MsgId>
Original Business Query	<OrgnlBizQry>
Message Identification	<MsgId>SFCDEFGHIJKLMNOPQRST123456789012345</MsgId>
End of Original Business Query	</OrgnlBizQry>
End of Message Header	</MsgHdr>
BusinessReportOrErrorChoice	<RptOrErr>
BusinessReport	<BizRpt>
TransactionReport	<TxRpt>
PaymentIdentification	<PmtId>
ProprietaryId	<PrtryId>ABCDEFGHIILBBBBITRRXXXABCDEFGHIIL1234567890ABC</PrtryId>
EndPaymentIdentification	</PmtId>
TransactionOrErrorChoice	<TxOrErr>
Transaction	<Tx>
PaymentTo	<PmtTo>
Member Identification	<Mmbld>
Financial Institution Identification	<FinInstnId>
BICFIIdentifier	<BICFI>BBBBIT22XXX</BICFI>
End of Financial Institution Identification	</FinInstnId>
End Member Identification	</Mmbld>
End PaymentTo	</PmtTo>
Payment From	<PmtFr>
Member Identification	<Mmbld>
Financial Institution Identification	<FinInstnId>
BICFIIdentifier	<BICFI>BBBBIT22XXX</BICFI>
End of Financial Institution Identification	</FinInstnId>
End Member Identification	</Mmbld>
End Payment From	</PmtFr>
Credit or debit indicator	<CdtDbtInd>CRDT</CdtDbtInd>
Payment	<Pmt>
RequestedExecutionDate	<ReqdExctnDt>
Date Time	<DtTm>2007-08-13T09:30:47+00:00</DtTm>
End of RequestedExecutionDate	</ReqdExctnDt>
PaymentStatus	<Sts>
PaymentStatusCode	<Cd>
Final	<Fnl>RJTD</Fnl>
End of PaymentStatusCode	</Cd>
DateTime	<DtTm>
Date Time	<DtTm>2007-08-13T09:30:47+00:00</DtTm>
End of DateTime	</DtTm>
Reason	<Rsn>
ProprietaryStatusJustification	<PrtryRjctn>
Proprietary Status Reason	<PrtryStsRsn>H001</PrtryStsRsn>
Reason	<Rsn>ERROR DESCRIPTION</Rsn>
End of ProprietaryStatusJustification	</PrtryRjctn>
End of Reason	</Rsn>
End of PaymentStatus	</Sts>
Instructed Amount	<InstdAmt>

Amount without currency	<AmtWthtCcy>716.52</AmtWthtCcy>
End Instructed Amount	</InstdAmt>
Type	<Tp>
Payment type code	<Cd>OND</Cd>
End of Type	</Tp>
TransactionIdentification	<TxId>1234567890123456</TxId>
Value date	<IntrBkStlmDt>2007-08-13+00:00</IntrBkStlmDt>
Parties	<Pties>
Creditor	<Cdtr>
Financial Institution Identification	<FinInstnId>
BICFIIdentifier	<BICFI>BBBBIT22XXX</BICFI>
End of Financial Institution Identification	</FinInstnId>
End of Creditor	</Cdtr>
End of Parties	</Pties>
End Payment	</Pmt>
End ofTransaction	</Tx>
End of TransactionOrErrorChoice	</TxOrErr>
End Transaction Report	</TxRpt>
TransactionReport	<TxRpt>
PaymentIdentification	<PmtId>
ProprietaryId	<PrtryId>ABCDEFGHILCLMNITRRXXBCDEFGHIL1234567890 ABC</PrtryId>
EndPaymentIdentification	</PmtId>
TransactionOrErrorChoice	<TxOrErr>
Transaction	<Tx>
PaymentTo	<PmtTo>
Member Identification	<Mmbld>
Financial Institution Identification	<FinInstnId>
BICFIIdentifier	<BICFI>BBBBIT22XXX</BICFI>
End of Financial Institution Identification	</FinInstnId>
End Member Identification	</Mmbld>
End PaymentTo	</PmtTo>
Payment From	<PmtFr>
Member Identification	<Mmbld>
Financial Institution Identification	<FinInstnId>
BICFIIdentifier	<BICFI>BBBBIT22XXX</BICFI>
End of Financial Institution Identification	</FinInstnId>
End Member Identification	</Mmbld>
End Payment From	</PmtFr>
Credit or debit indicator	<CdtDbtInd>DBIT</CdtDbtInd>
Payment	<Pmt>
RequestedExecutionDate	<ReqdExctnDt>
Date Time	<DtTm>2007-08-13T09:31:47+00:00</DtTm>
End of RequestedExecutionDate	</ReqdExctnDt>
PaymentStatus	<Sts>
PaymentStatusCode	<Cd>
Final	<Fnl>STLD</Fnl>
End of PaymentStatusCode	</Cd>
DateTime	<DtTm>
Date Time	<DtTm>2007-08-13T09:30:47+00:00</DtTm>
End of DateTime	</DtTm>
End of PaymentStatus	</Sts>
Instructed Amount	<InstdAmt>

Amount without currency						<AmtWthtCcy>1005.68</AmtWthtCcy>
End Instructed Amount						</InstdAmt>
ProcessingValidityTime						<PrcgVldtyTm>
From Date Time						<FrDtTm>2007-08-13T09:31:47+00:00</FrDtTm>
End Processing Validity Time						</PrcgVldtyTm>
Type						<Tp>
Payment type code						<Cd>-</Cd>
End of Type						</Tp>
TransactionIdentification						<TxId>A234567890123456</TxId>
Value date						<IntrBkSttlmDt>2007-08-13+00:00</IntrBkSttlmDt>
Parties						<Pties>
Creditor						<Cdtr>
Financial Institution Identification						<FinInstnId>
BICFIIdentifier						<BICFI>BBBBIT22XXX</BICFI>
End of Financial Institution Identification						</FinInstnId>
End of Creditor						</Cdtr>
End of Parties						</Pties>
End Payment						</Pmt>
End ofTransaction						</Tx>
End of TransactionOrErrorChoice						</TxOrErr>
End Transaction Report						</TxRpt>
End of BusinessReport						</BizRpt>
End of BusinessReportOrErrorChoice						</RptOrErr>
End messagename ReturnTransaction						</RtrTx>

6. 9 XML messages related to RM

6. 9. 1 AuthorizePenalty (for CBs only)

SSP Proprietary Messages

AuthorizePenalty_RM

Scope: The Authorise Penalty Message is used by NCBs to authorise or cancel penalties for infringements of minimum reserve. This message will be replied by a Receipt Message. Non repudiation of emission (NRE) is supported.

<camt.998.001.xx>

Structure:

Name Proprietary message	<PrtryMsg>
Message Header	<MsgHdr>
Message Identification	<MsgId></MsgId>
End of Message Header	</MsgHdr>
Proprietary Data	<PrtryData>
Type	<Tp>AuthorizePenalty</Tp>
Proprietary Data	<Data>
SSP Proprietary Data	<SspPrtryDt>
Penalty Management Identification Details	<PnltyMgmtId>
Type	<Tp></Tp>
Counterparty Identification	<CtrPtyId>
BIC	<BIC></BIC>
End Counterparty Identification	</CtrPtyId>
End Penalty Management Identification Details	</PnltyMgmtId>
New Penalty Value Set	<NewPnltyValSet>
Maintenance Period	<MntncPrd>
Start Date	<FrDt></FrDt>
End Date	<ToDt></ToDt>
End Manteinance Period	</MntncPrd>
PenaltyType	<PnltyTp></PnltyTp>
Penalty Status	<PnltySts></PnltySts>
End New Penalty Value Set	</NewPnltyValSet>
End of SSP Proprietary Data	</SspPrtryDt>
End of Proprietary Data	</Data>
End of Proprietary Data	</PrtryData>
End proprietary message	</PrtryMsg>

Attributes:

name of attribute	format	short description	description
<PrtryMsg>		Name Proprietary message Mandatory	Validation: [1..1]
<MsgHdr>		Message Header Mandatory	Set of characteristics specific to the message Validation: [1..1]
<MsgId>-</MsgId>	35x	Message Identification Mandatory	Message Identification String of characters that uniquely identifies a message at senders side. Validation: [1..1]
</MsgHdr>		End of Message Header Mandatory	Validation: [1..1]
<PrtryData>		Proprietary Data Mandatory	Proprietary Data Validation: [1..1]
<Tp>-</Tp>	35x	Type Mandatory	Identifies the type of message. It must be: "AuthorizePenalty". Validation: [1..1]
<Data>		Proprietary Data Mandatory	Proprietary data content Validation: [1..1]
<SspPrtryDt>		SSP Proprietary Data Mandatory	Root element for all SSP proprietary data Validation: [1..1]
<PnltyMgmtId>		Penalty Management Identification Details Mandatory	Validation: [1..1]
<Tp>-</Tp>	35x	Type Mandatory	It must be: "BLCK". Validation: [1..1]
<CtrPtyId>		Counterparty Identification Mandatory	Validation: [1..1]
<BIC>-</BIC>	11x	BIC Mandatory	BIC of the participant to whom data are referred. Validation: [1..1]
</CtrPtyId>		End Counterparty Identification Mandatory	Validation:

name of attribute	format	short description	description
			[1..1]
</PnltyMgmtId>		End Penalty Management Identification Details Mandatory	Validation: [1..1]
<NewPnltyValSet>		New Penalty Value Set Mandatory	Validation: [1..1]
<MntncPrd>		Maintenance Period Mandatory	Maintenance period to which data are referred. Validation: [1..1]
<FrDt>-</FrDt>	DateTime	Start Date Mandatory	Start date of the maintenance period (yyyy-mm-dd). Validation: [1..1]
<ToDt>-</ToDt>	Date	End Date Mandatory	End date of the maintenance period (yyyy-mm-dd). Validation: [1..1]
</MntncPrd>		End Manteinance Period Mandatory	Validation: [1..1]
<PnltyTp>-</PnltyTp>	3x	PenaltyType Optional	Specifies the type of penalty to authorise. It can be: "ONE" (penalty for simple infringement) or "TWO" (penalty for repeated infringements). The attribute is mandatory when <PnltySts> is valorised as "PAY". Validation: [0..1]
<PnltySts>-</PnltySts>	5x	Penalty Status Mandatory	It must be: "PAY" (for authorising penalty) or "NOPAY" (for cancelling penalty). Validation: [1..1]
</NewPnltyValSet>		End New Penalty Value Set Mandatory	Validation: [1..1]
</SspPrtryDt>		End of SSP Proprietary Data Mandatory	End of SSP Proprietary Data Validation: [1..1]
</Data>		End of Proprietary Data Mandatory	Validation: [1..1]
</PrtryData>		End of Proprietary Data Mandatory	End of Proprietary Data Validation: [1..1]
</PrtryMsg>		End proprietary message Mandatory	Validation:

name of attribute	format	short description	description
[1..1]			

Error Codes:

Order	Error code				Error Text / Validation/ Remark
	SSP	Y-copy	V-shape	XML	
1	X41			1401	Error Text: No permission. RBAC User role(s) are not sufficient. Validation: RBAC role name "APPLICBTE" is required Remark: checked by ICM / Receipt
2	X44			1404	Error Text: If "non repudiation of emission" is mandatory, the NRE indicator flag has to be present Validation: If non-repudiaton processing is mandatory, the tag <SwInt:NRIndicator>TRUE</SwInt:NRIndicator> has to be present. Remark: Receipt /checked by ICM
3	861	C1	RF01	2861	Error Text: Double input Validation: Remark:
4	H13			H013	Error Text: Requested field missing in input Validation: Remark:
5	H11			H011	Error Text: Requested BIC unknown Validation: Remark:
6	H09			H009	Error Text: Parameter logical error <.> Validation: Remark:
7	H08			H008	Error Text: Requestor unknown Validation: Remark:
8	H04	M4	XT16	H004	Error Text: Operation not allowed (e.g. cross border) Validation: Remark:
9	H01		XI01	H001	Error Text: Sender not allowed Validation: Remark:

AuthorizePenalty_RM_1

Scope: Request to authorise the payment of penalty type 1 (penalty for simple infringements)

Name Proprietary message	<PrtryMsg>
Message Header	<MsgHdr>
Message Identification	<MsgId>RMCDEFGHIJKLMNOPQRST123456789012345</MsgId>
End of Message Header	</MsgHdr>
Proprietary Data	<PrtryData>
Type	<Tp>AuthorizePenalty</Tp>
Proprietary Data	<Data>
SSP Proprietary Data	<SspPrtryDt>
Penalty Management Identification Details	<PnltyMgmtId>
Type	<Tp>BLCK</Tp>
Counterparty Identification	<CtrPtyId>
BIC	<BIC>AAAAITRRAAA</BIC>
End Counterparty Identification	</CtrPtyId>
End Penalty Management Identification Details	</PnltyMgmtId>
New Penalty Value Set	<NewPnltyValSet>
Maintenance Period	<MntncPrd>
Start Date	<FrDt>2007-09-15</FrDt>
End Date	<ToDt>2007-10-23</ToDt>
End Manteinance Period	</MntncPrd>
PenaltyType	<PnltyTp>ONE</PnltyTp>
Penalty Status	<PnltySts>PAY</PnltySts>
End New Penalty Value Set	</NewPnltyValSet>
End of SSP Proprietary Data	</SspPrtryDt>
End of Proprietary Data	</Data>
End of Proprietary Data	</PrtryData>
End proprietary message	</PrtryMsg>

6. 9. 2 GetAccount

Cash Management Standard

GetAccount_RM

Scope: The Get Account Message is used by a participant (or by the NCBs or the co-manager on behalf of the participant) to request information about the fulfilment of the minimum reserve. This message will be replied by a Return Account Message.

<camt.003.001.xx>

Structure:

Message Type	<GetAcct>
Message Header	<MsgHdr>
Message Identification	<MsgId></MsgId>
End of Message Header	</MsgHdr>
Specification of the query criteria.	<AcctQryDef>
Account Criteria	<AcctCrit>
NewCriteria	<NewCrit>
SearchCriteria	<SchCrit>
Account Owner	<AcctOwnr>
Identification	<Id>
OrganisationIdentification	<OrgId>
AnyBICIdentifier	<AnyBIC></AnyBIC>
End of OrganisationIdentification	</OrgId>
End Identification	</Id>
End of Account owner	</AcctOwnr>
End of SearchCriteria	</SchCrit>
End of NewCriteria	</NewCrit>
End Account Criteria	</AcctCrit>
End Account Query Definition	</AcctQryDef>
End of Message Type	</GetAcct>

Attributes:

name of attribute	format	short description	description
<GetAcct>		Message Type	Message name for GetAccount
		Mandatory	Validation: [1..1]
<MsgHdr>		Message Header	Set of characteristics specific to the message
		Mandatory	Validation: [1..1]
<MsgId>-</MsgId>	35x	Message Identification	Message Identification String of characters that uniquely identifies a message at senders side.
		Mandatory	Validation: [1..1]
</MsgHdr>		End of Message Header	
		Mandatory	Validation: [1..1]
<AcctQryDef>		Specification of the query criteria.	
		Mandatory	Validation: [0..1]
<AcctCrit>		Account Criteria	
		Mandatory	Validation: [0..1]
<NewCrit>		NewCriteria	
		Mandatory	Validation: [1..1]
<SchCrit>		SearchCriteria	
		Mandatory	Validation: [0..1]
<AcctOwnr>		Account Owner	
		Optional	Validation: [0..1]
<Id>		Identification	
		Mandatory	Validation: [1..1]
<OrgId>		OrganisationIdentification	OrganisationIdentification
		Mandatory	Validation: [1..1]
<AnyBIC>-</AnyBIC>	4!a2!a2!c[3!cAnyBICIdentifier]		AnyBICIdentifier / BIC used on behalf of third parties BIC of the participant to whom data are referred. The attribute is mandatory when the requestor is the co-manager of the participant or the NCB.
		Mandatory	Validation: [1..1]
</OrgId>		End of OrganisationIdentification	End of OrganisationIdentification
		Mandatory	Validation: [1..1]

name of attribute	format	short description	description
</Id>		End Identification Mandatory	Validation: [1..1]
</AcctOwnr>		End of Account owner Optional	Validation: [0..1]
</SchCrit>		End of SearchCriteria Mandatory	Validation: [0..1]
</NewCrit>		End of NewCriteria Mandatory	Validation: [1..1]
</AcctCrit>		End Account Criteria Mandatory	Validation: [0..1]
</AcctQryDef>		End Account Query Definition Mandatory	Validation: [0..1]
</GetAcct>		End of Message Type Mandatory	End of GetAccount Validation: [1..1]

Error Codes:

Order	Error code				Error Text / Validation/ Remark
	SSP	Y-copy	V-shape	XML	
1	X41			1401	Error Text: No permission. RBAC User role(s) are not sufficient. Validation: RBAC role name "APPLICATE", "APPLICSTE" or "APPLICBTE" are required Remark: checked by ICM / ReturnAccount
2	866	C6	AC06	2866	Error Text: Exclusion of participant Validation: Remark:
3	H11			H011	Error Text: Requested BIC unknown Validation: Remark:
4	H08			H008	Error Text: Requestor unknown Validation: Remark:
5	H06			H006	Error Text: No data available (e.g. an empty list) Validation: Remark:
6	H04	M4	XT16	H004	Error Text: Operation not allowed (e.g. cross border) Validation: Remark:

GetAccount_RM_1

Scope: Request of information about the fulfilment of the minimum reserve of a participant, sent by the NCB of the participant.

Message Type	<GetAcct>
Message Header	<MsgHdr>
Message Identification	<MsgId>RMCDEFGHIJKLMNOPQRST123456789012345</MsgId>
End of Message Header	</MsgHdr>
Specification of the query criteria.	<AcctQryDef>
Account Criteria	<AcctCrit>
NewCriteria	<NewCrit>
SearchCriteria	<SchCrit>
Account Owner	<AcctOwnr>
Identification	<Id>
OrganisationIdentification	<OrgId>
AnyBICIdentifier	<AnyBIC>BBBITRRXXX</AnyBIC>
End of OrganisationIdentification	</OrgId>
End Identification	</Id>
End of Account owner	</AcctOwnr>
End of SearchCriteria	</SchCrit>
End of NewCriteria	</NewCrit>
End Account Criteria	</AcctCrit>
End Account Query Definition	</AcctQryDef>
End of Message Type	</GetAcct>

6. 9. 3 GetCompulsoryReserve (for CBs only)

SSP Proprietary Messages

GetCompulsoryReserve_RM

Scope: The Get Compulsory Reserve Message is used by NCBs to request the list of the minimum reserve values for all the participants belonging to the requesting NCB. The request must refer to a specific maintenance period that could be either: (i) the current maintenance period or (ii) the next maintenance period. This message will be replied by a Return Compulsory Reserve Message.

<camt.998.001.xx>

Structure:

Message Type	<PrtryMsg>
Message Header	<MsgHdr>
Message Identification	<MsgId></MsgId>
End of Message Header	</MsgHdr>
Proprietary Data	<PrtryData>
Type	<Tp>GetCompulsoryReserve</Tp>
Proprietary Data	<Data>
SSP Proprietary Data	<SspPrtryDt>
Compulsory reserve management Identification	<CmplryRsrvMgmtId>
Type	<Tp></Tp>
End compulsory reserve management Identification	</CmplryRsrvMgmtId>
Maintenance Period	<MntncPrd>
Date From	<FrDt></FrDt>
Date Till	<ToDt></ToDt>
End Manteinance Period	</MntncPrd>
End of SSP Proprietary Data	</SspPrtryDt>
End of Proprietary Data	</Data>
End of Proprietary Data	</PrtryData>
End proprietary message	</PrtryMsg>

Attributes:

name of attribute	format	short description	description
<PrtryMsg>		Message Type Mandatory	Validation: [1..1]
<MsgHdr>		Message Header Mandatory	Set of characteristics specific to the message Validation: [1..1]
<MsgId>-</MsgId>	35x	Message Identification Mandatory	Message Identification String of characters that uniquely identifies a message at senders side. Validation: [1..1]
</MsgHdr>		End of Message Header Mandatory	Validation: [1..1]
<PrtryData>		Proprietary Data Mandatory	Proprietary Data Validation: [1..1]
<Tp>-</Tp>	35x	Type Mandatory	It must be GetCompulsoryReserve Validation: [1..1]
<Data>		Proprietary Data Mandatory	Proprietary data content Validation: [1..1]
<SspPrtryDt>		SSP Proprietary Data Mandatory	SSP Proprietary Data Validation: [1..1]
<CmplryRsrvMgmtId>		Compulsory reserve management Identification Mandatory	Validation: [1..1]
<Tp>-</Tp>	35x	Type Mandatory	It must be BLCK Validation: [1..1]
</CmplryRsrvMgmtId>		End compulsory reserve management Identification Mandatory	Validation: [1..1]
<MntncPrd>		Maintenance Period Optional	If not present, data related to the current maintenance period will be provided. Validation: [0..1]
<FrDt>-</FrDt>	ISODate	Date From Mandatory	Start date of the maintainance period (yyyy-mm-dd) Validation:

name of attribute	format	short description	description
			[1..1]
<ToDt>-</ToDt>	ISODate	Date Till	Date within a particular calendar year represented by YYYY-MM-DD (ISO 8601). End date of the maintenance period (yyyy-mm-dd) If StartDatePeriod is present, also EndDatePeriod must be present. Mandatory Validation: [1..1]
</MntncPrd>		End Manteinance Period	Optional Validation: [0..1]
</SspPrtryDt>		End of SSP Proprietary Data	End of Root element for all SSP proprietary data Mandatory Validation: [1..1]
</Data>		End of Proprietary Data	Mandatory Validation: [1..1]
</PrtryData>		End of Proprietary Data	End of Proprietary Data Mandatory Validation: [1..1]
</PrtryMsg>		End proprietary message	Mandatory Validation: [1..1]

Error Codes:

Order	Error code				Error Text / Validation/ Remark
	SSP	Y-copy	V-shape	XML	
1	X41			1401	Error Text: No permission. RBAC User role(s) are not sufficient. Validation: RBAC role name "APPLICBTE" is required Remark: checked by ICM / ReturnCompulsoryReserve
2	H06			H006	Error Text: No data available (e.g. an empty list) Validation: Remark:
3	H04	M4	XT16	H004	Error Text: Operation not allowed (e.g. cross border) Validation: Remark:
4	H01		XI01	H001	Error Text: Sender not allowed Validation: Remark:
5	H09			H009	Error Text: Parameter logical error <.> Validation: Remark:
6	H08			H008	Error Text: Requestor unknown Validation: Remark:

GetCompulsoryReserve_RM_1

Scope: Request of information about the value of the minimum reserve, in the following maintenance period, of all the participants of the requesting NCB

Message Type	<PrtryMsg>
Message Header	<MsgHdr>
Message Identification	<MsgId>ABCDEFGHIJKLMNQRST123456789012345</MsgId>
End of Message Header	</MsgHdr>
Proprietary Data	<PrtryData>
Type	<Tp>GetCompulsoryReserve</Tp>
Proprietary Data	<Data>
SSP Proprietary Data	<SspPrtryDt>
Compulsory reserve management Identification	<CmplryRsrvMgmtId>
Type	<Tp>BLCK</Tp>
End compulsory reserve management Identification	</CmplryRsrvMgmtId>
Maintenance Period	<MntncPrd>
Date From	<FrDt>2011-10-11</FrDt>
Date Till	<ToDt>2011-11-18</ToDt>
End Manteinance Period	</MntncPrd>
End of SSP Proprietary Data	</SspPrtryDt>
End of Proprietary Data	</Data>
End of Proprietary Data	</PrtryData>
End proprietary message	</PrtryMsg>

6. 9. 4 GetPenalty (for CBs only)

SSP Proprietary Messages

GetPenalty_ RM

Scope: The Get Penalty Message is used by NCBs to request information about penalties for infringement of minimum reserve. This message will be replied by a Return Penalty Message.

<camt.998.001.xx>

Structure:

Name Proprietary message	<PrtryMsg>
Message Header	<MsgHdr>
Message Identification	<MsgId></MsgId>
End of Message Header	</MsgHdr>
Proprietary Data	<PrtryData>
Type	<Tp>GetPenalty</Tp>
Proprietary Data	<Data>
SSP Proprietary Data	<SspPrtryDt>
Penalty Management Identification Details	<PnltyMgmtId>
Type	<Tp></Tp>
Counterparty Identification	<CtrPtyId>
BIC	<BIC></BIC>
End Counterparty Identification	</CtrPtyId>
End Penalty Management Identification Details	</PnltyMgmtId>
Maintenance Period	<MntncPrd>
Start Date	<FrDt></FrDt>
End Date	<ToDt></ToDt>
End Manteinance Period	</MntncPrd>
Penalty Status	<PnltySts></PnltySts>
End of SSP Proprietary Data	</SspPrtryDt>
End of Proprietary Data	</Data>
End of Proprietary Data	</PrtryData>
End proprietary message	</PrtryMsg>

Attributes:

name of attribute	format	short description	description
<PrtryMsg>		Name Proprietary message Mandatory	Validation: [1..1]
<MsgHdr>		Message Header Mandatory	Set of characteristics specific to the message Validation: [1..1]
<MsgId>-</MsgId>	35x	Message Identification Mandatory	Message Identification String of characters that uniquely identifies a message at senders side. Validation: [1..1]
</MsgHdr>		End of Message Header Mandatory	Validation: [1..1]
<PrtryData>		Proprietary Data Mandatory	Proprietary Data Validation: [1..1]
<Tp>-</Tp>	35x	Type Mandatory	Identifies the type of message. It must be: "GetPenalty". Validation: [1..1]
<Data>		Proprietary Data Mandatory	Proprietary data content Validation: [1..1]
<SspPrtryDt>		SSP Proprietary Data Mandatory	SSP Proprietary Data Validation: [1..1]
<PnltyMgmtId>		Penalty Management Identification Details Mandatory	Validation: [1..1]
<Tp>-</Tp>	35x	Type Mandatory	It must be: "BLCK". Validation: [1..1]
<CtrPtyId>		Counterparty Identification Optional	Container for the identification of the participant to whom data are referred. If not present, data related to all participants of the requesting NCB will be returned. Validation: [0..1]
<BIC>-</BIC>	11x	BIC Mandatory	BIC of the participant to whom data are referred. Validation: [1..1]
</CtrPtyId>		End Counterparty Identification	

name of attribute	format	short description	description
		Optional	Validation: [0..1]
</PnltyMgmtId>		End Penalty Management Identification Details Mandatory	Validation: [1..1]
<MntncPrd>		Maintenance Period Optional	Container for the identification of the maintenance period to which data are referred. If not present, data related to all maintenance periods will be returned. Validation: [0..1]
<FrDt>-</FrDt>	DateTime	Start Date Mandatory	Start date of the maintenance period (yyyy-mm-dd). Validation: [1..1]
<ToDt>-</ToDt>	Date	End Date Mandatory	End date of the maintenance period (yyyy-mm-dd). Validation: [1..1]
</MntncPrd>		End Maintenance Period Optional	Validation: [0..1]
<PnltySts>-</PnltySts>	5x	Penalty Status Optional	Status of penalty. It can be: "PAY" (authorized); "WAIT" (waiting); "NOPAY" (cancelled). If PenaltyStatus is not present, data related to all possible status will be returned. Validation: [0..1]
</SspPrtryDt>		End of SSP Proprietary Data Mandatory	End of SSP Proprietary Data Validation: [1..1]
</Data>		End of Proprietary Data Mandatory	Validation: [1..1]
</PrtryData>		End of Proprietary Data Mandatory	End of Proprietary Data Validation: [1..1]
</PrtryMsg>		End proprietary message Mandatory	Validation: [1..1]

Error Codes:

Order	Error code				Error Text / Validation/ Remark
	SSP	Y-copy	V-shape	XML	
1	X41			1401	Error Text: No permission. RBAC User role(s) are not sufficient. Validation: RBAC role name "APPLICBTE" is required Remark: checked by ICM / ReturnPenalty
3	H11			H011	Error Text: Requested BIC unknown Validation: Remark:
4	H10	M1		H010	Error Text: Data not found (request data does not exist) Validation: Remark:
5	H09			H009	Error Text: Parameter logical error <.> Validation: Remark:
6	H08			H008	Error Text: Requestor unknown Validation: Remark:
7	H06			H006	Error Text: No data available (e.g. an empty list) Validation: Remark:
8	H04	M4	XT16	H004	Error Text: Operation not allowed (e.g. cross border) Validation: Remark:
9	H01		XI01	H001	Error Text: Sender not allowed Validation: Remark:

GetPenalty_RM_1

Scope: Request of information about penalties related to a specific maintenance period, for all participants and all possible status

Name Proprietary message	<PrtryMsg>
Message Header	<MsgHdr>
Message Identification	<MsgId>RMCDEFGHIJKLMNOPQRST123456789012345</MsgId>
End of Message Header	</MsgId>
Proprietary Data	<PrtryData>
Type	<Tp>GetPenalty</Tp>
Proprietary Data	<Data>
SSP Proprietary Data	<SspPrtryDt>
Penalty Management Identification Details	<PnltyMgmtId>
Type	<Tp>BLCK</Tp>
End Penalty Management Identification Details	</PnltyMgmtId>
Maintenance Period	<MntncPrd>
Start Date	<FrDt>2007-09-15</FrDt>
End Date	<ToDt>2007-10-23</ToDt>
End Manteinance Period	</MntncPrd>
End of SSP Proprietary Data	</SspPrtryDt>
End of Proprietary Data	</Data>
End of Proprietary Data	</PrtryData>
End proprietary message	</PrtryMsg>

6. 9. 5 InsertCompulsoryReserve (for CBs only)

SSP Proprietary Messages

InsertCompulsoryReserve_RM

Scope: The Insert Compulsory Reserve Message is used by NCBs to entry the value of the minimum reserve for each credit institution. This message will be replied by a Receipt Message. Non repudiation of emission (NRE) is supported.

<camt.998.001.xx>

Structure:

Name Proprietary message	<PrtryMsg>
Message Header	<MsgHdr>
Message Identification	<MsgId></MsgId>
End of Message Header	</MsgHdr>
Proprietary Data	<PrtryData>
Type	<Tp>InsertCompulsoryReserve</Tp>
Proprietary Data	<Data>
SSP Proprietary Data	<SspPrtryDt>
Compulsory reserve management Identification	<CmplryRsrvMgmtId>
Type	<Tp></Tp>
Counterparty Identification	<CtrPtyId>
BIC	<BIC></BIC>
End Counterparty Identification	</CtrPtyId>
End compulsory reserve management Identification	</CmplryRsrvMgmtId>
New Compulsory Reserve Value Set	<NewCmplryRsrvValSet>
Maintenance Period	<MntncPrd>
Start Date	<FrDt></FrDt>
End Date	<ToDt></ToDt>
End Manteinance Period	</MntncPrd>
Amount	<Amt></Amt>
End New Compulsory Reserve Value Set	</NewCmplryRsrvValSet>
End of SSP Proprietary Data	</SspPrtryDt>
End of Proprietary Data	</Data>
End of Proprietary Data	</PrtryData>
End proprietary message	</PrtryMsg>

Attributes:

name of attribute	format	short description	description
<PrtryMsg>		Name Proprietary message Mandatory	Validation: [1..1]
<MsgHdr>		Message Header Mandatory	Set of characteristics specific to the message Validation: [1..1]
<MsgId>-</MsgId>	35x	Message Identification Mandatory	Message Identification String of characters that uniquely identifies a message at senders side. Validation: [1..1]
</MsgHdr>		End of Message Header Mandatory	Validation: [1..1]
<PrtryData>		Proprietary Data Mandatory	Proprietary Data Validation: [1..1]
<Tp>-</Tp>	35x	Type Mandatory	Identifies the type of message. It must be: "InsertCompulsoryReserve". Validation: [1..1]
<Data>		Proprietary Data Mandatory	Proprietary data content Validation: [1..1]
<SspPrtryDt>		SSP Proprietary Data Mandatory	SSP Proprietary Data Validation: [1..1]
<CmplryRsrvMgmtId>		Compulsory reserve management Identification Mandatory	Validation: [1..1]
<Tp>-</Tp>	35x	Type Mandatory	It must be: "BLCK" (Minimum Reserve). Validation: [1..1]
<CtrPtyId>		Counterparty Identification Mandatory	Validation: [1..1]
<BIC>-</BIC>	11x	BIC Mandatory	BIC of the participant to whom data are referred. Validation: [1..1]
</CtrPtyId>		End Counterparty Identification Mandatory	Validation:

name of attribute	format	short description	description
			[1..1]
</CmplryRsrvMgmtId>		End compulsory reserve management Identification Mandatory	Validation: [1..1]
<NewCmplryRsrvValSet>		New Compulsory Reserve Value Set Mandatory	Validation: [1..1]
<MntncPrd>		Maintenance Period Mandatory	Container for the identification of the maintenance period to which data are referred. Validation: [1..1]
<FrDt>-</FrDt>	DateTime	Start Date Mandatory	Start date of the maintenance period (yyyy-mm-dd). Validation: [1..1]
<ToDt>-</ToDt>	Date	End Date Mandatory	End date of the maintenance period (yyyy-mm-dd). Validation: [1..1]
</MntncPrd>		End Manteinance Period Mandatory	Validation: [1..1]
<Amt>-</Amt>	14n	Amount Mandatory	Amount of minimum reserve . Validation: [1..1]
</NewCmplryRsrvValSet>		End New Compulsory Reserve Value Set Mandatory	Validation: [1..1]
</SspPrtryDt>		End of SSP Proprietary Data Mandatory	End of SSP Proprietary Data Validation: [1..1]
</Data>		End of Proprietary Data Mandatory	Validation: [1..1]
</PrtryData>		End of Proprietary Data Mandatory	End of Proprietary Data Validation: [1..1]
</PrtryMsg>		End proprietary message Mandatory	Validation: [1..1]

Error Codes:

Order	Error code				Error Text / Validation/ Remark
	SSP	Y-copy	V-shape	XML	
1	X41			1401	Error Text: No permission. RBAC User role(s) are not sufficient. Validation: RBAC role name "APPLICBTE" is required Remark: checked by ICM / Receipt
2	X44			1404	Error Text: If "non repudiation of emission" is mandatory, the NRE indicator flag has to be present Validation: If non-repudiaton processing is mandatory, the tag <SwInt:NRIndicator>TRUE</SwInt:NRIndicator> has to be present. Remark: Receipt /checked by ICM
3	868	C8	XI19	2868	Error Text: Invalid sending/receiving BIC Validation: Remark:
4	861	C1	RF01	2861	Error Text: Double input Validation: Remark:
5	H11			H011	Error Text: Requested BIC unknown Validation: Remark:
6	H09			H009	Error Text: Parameter logical error <.> Validation: Remark:
7	H08			H008	Error Text: Requestor unknown Validation: Remark:
8	H04	M4	XT16	H004	Error Text: Operation not allowed (e.g. cross border) Validation: Remark:
9	H01		XI01	H001	Error Text: Sender not allowed Validation: Remark:

InsertCompulsoryReserve_RM_1

Scope: Request to entry the value of the compulsory of a participant

Name Proprietary message	<PrtryMsg>
Message Header	<MsgHdr>
Message Identification	<MsgId>RMCDEFGHIJKLMNOPQRST123456789012345</MsgId>
End of Message Header	</MsgHdr>
Proprietary Data	<PrtryData>
Type	<Tp>InsertCompulsoryReserve</Tp>
Proprietary Data	<Data>
SSP Proprietary Data	<SspPrtryDt>
Compulsory reserve management Identification	<CmplryRsrvMgmtId>
Type	<Tp>BLCK</Tp>
Counterparty Identification	<CtrPtyId>
BIC	<BIC>AAAAITRR123</BIC>
End Counterparty Identification	</CtrPtyId>
End compulsory reserve management Identification	</CmplryRsrvMgmtId>
New Compulsory Reserve Value Set	<NewCmplryRsrvValSet>
Maintenance Period	<MntncPrd>
Start Date	<FrDt>2008-04-15</FrDt>
End Date	<ToDt>2008-05-23</ToDt>
End Manteinance Period	</MntncPrd>
Amount	<Amt>100000.00</Amt>
End New Compulsory Reserve Value Set	</NewCmplryRsrvValSet>
End of SSP Proprietary Data	</SspPrtryDt>
End of Proprietary Data	</Data>
End of Proprietary Data	</PrtryData>
End proprietary message	</PrtryMsg>

6.9.6 InsertPHABalance (for CBs only)

SSP Proprietary Messages

InsertPHABalance_RM

Scope: The Insert PHA Balance Message is used by NCBs to send information about the end of day balance of accounts held at PHA and also on PM and HAM. This message will be replied by a Receipt Message. Non repudiation of emission (NRE) is supported.

<camt.998.001.xx>

Structure:

Name Proprietary message	<PrtryMsg>
Message Header	<MsgHdr>
Message Identification	<MsgId></MsgId>
End of Message Header	</MsgHdr>
Proprietary Data	<PrtryData>
Type	<Tp>InsertPHABalance</Tp>
Proprietary Data	<Data>
SSP Proprietary Data	<SspPrtryDt>
PHA Management Identification	<PHAMgmtId>
Country Code	<Ctry></Ctry>
End PHA Management Identification	</PHAMgmtId>
Number of Items	<NbOfItms></NbOfItms>
Total Number of Items	<TotNbOfItms></TotNbOfItms>
New PHA Balance Value Set	<NewPHABalValSet>
Counterparty Identification	<CtrPtyId>
BIC	<BIC></BIC>
End Counterparty Identification	</CtrPtyId>
PHA Balance	<PHABal>
Amount	<Amt></Amt>
Credit or debit indicator	<CdtDbtInd></CdtDbtInd>
Type	<Tp></Tp>
Value Date	<ValDt>
Value Date	<Dt></Dt>
End Value Date	</ValDt>
End PHA Balance	</PHABal>
End New PHA Balance Value Set	</NewPHABalValSet>
End of SSP Proprietary Data	</SspPrtryDt>
End of Proprietary Data	</Data>
End of Proprietary Data	</PrtryData>
End proprietary message	</PrtryMsg>

Attributes:

name of attribute	format	short description	description
<PrtryMsg>		Name Proprietary message Mandatory	Validation: [1..1]
<MsgHdr>		Message Header Mandatory	Set of characteristics specific to the message Validation: [1..1]
<MsgId>-</MsgId>	35x	Message Identification Mandatory	Message Identification String of characters that uniquely identifies a message at senders side. Validation: [1..1]
</MsgHdr>		End of Message Header Mandatory	Validation: [1..1]
<PrtryData>		Proprietary Data Mandatory	Proprietary Data Validation: [1..1]
<Tp>-</Tp>	35x	Type Mandatory	Identifies the type of message. It must be: "InsertPHABalance". Validation: [1..1]
<Data>		Proprietary Data Mandatory	Proprietary data content Validation: [1..1]
<SspPrtryDt>		SSP Proprietary Data Mandatory	SSP Proprietary Data Validation: [1..1]
<PHAMgmtId>		PHA Management Identification Mandatory	Validation: [1..1]
<Ctry>-</Ctry>	2!a	Country Code Mandatory	Country Code Country Code of the NCB. Validation: [1..1]
</PHAMgmtId>		End PHA Management Identification Mandatory	Validation: [1..1]
<NbOfItms>-</NbOfItms>	18n	Number of Items Mandatory	Progressive number of the XML message (a single XML message for each account balance has to be sent) (18.0). Validation: [1..1]
<TotNbOfItms>-</TotNbOfItms>	18n	Total Number of Items	Total number of XML messages to be sent by the NCB

name of attribute	format	short description	description
			(18.0) Validation: [1..1]
<NewPHABalValSet>		New PHA Balance Value Set Mandatory	Validation: [1..1]
<CtrPtyId>		Counterparty Identification Mandatory	Validation: [1..1]
<BIC>-</BIC>	11x	BIC Mandatory	BIC of the participant to whom data are referred. Validation: [1..1]
</CtrPtyId>		End Counterparty Identification Mandatory	Validation: [1..1]
<PHABal>		PHA Balance Mandatory	Validation: [1..1]
<Amt>-</Amt>	14n	Amount Mandatory	Account balance . Validation: [1..1]
<CdtDbtInd>-</CdtDbtInd>	4!a	Credit or debit indicator Mandatory	Credit debit indicator. It must be: "CRDT"(credit). Validation: [1..1]
<Tp>-</Tp>	35x	Type Mandatory	Balance type. It must be: "CLSG" (closing balance). Validation: [1..1]
<ValDt>		Value Date Mandatory	Validation: [1..1]
<Dt>-</Dt>	Date	Value Date Mandatory	Balance date (yyyy-mm-dd). Validation: [1..1]
</ValDt>		End Value Date Mandatory	Validation: [1..1]
</PHABal>		End PHA Balance Mandatory	Validation: [1..1]
</NewPHABalValSet>		End New PHA Balance Value Set Mandatory	Validation: [1..1]

name of attribute	format	short description	description
</SspPrtryDt>		End of SSP Proprietary Data Mandatory	End of SSP Proprietary Data Validation: [1..1]
</Data>		End of Proprietary Data Mandatory	Validation: [1..1]
</PrtryData>		End of Proprietary Data Mandatory	End of Proprietary Data Validation: [1..1]
</PrtryMsg>		End proprietary message Mandatory	Validation: [1..1]

Error Codes:

Order	Error code				Error Text / Validation/ Remark
	SSP	Y-copy	V-shape	XML	
1	X41			1401	Error Text: No permission. RBAC User role(s) are not sufficient. Validation: RBAC role name "APPLICBTE" is required Remark: checked by ICM / Receipt
2	X44			1404	Error Text: If "non repudiation of emission" is mandatory, the NRE indicator flag has to be present Validation: If non-repudiaton processing is mandatory, the tag <SwInt:NRIndicator>TRUE</SwInt:NRIndicator> has to be present. Remark: Receipt /checked by ICM
3	861	C1	RF01	2861	Error Text: Double input Validation: Remark:
4	852	B2	XI12	2852	Error Text: Invalid character or invalid numeric value Validation: Remark:
6	H09			H009	Error Text: Parameter logical error <.> Validation: Remark:
7	H08			H008	Error Text: Requestor unknown Validation: Remark:
8	H07	M7		H007	Error Text: Account not open Validation: Remark:
9	H04	M4	XT16	H004	Error Text: Operation not allowed (e.g. cross border) Validation: Remark:
10	H01		XI01	H001	Error Text: Sender not allowed Validation: Remark:

InsertPHABalance_RM_1

Scope: Request to insert the end of day balance of an account held at PHA and also on PM and HAM (last message of a total of 2 messages)

Name Proprietary message	<PrtryMsg>
Message Header	<MsgHdr>
Message Identification	<Msgld>RMCDEFGHIJKLMNOPQRST123456789012345</Msgld>
End of Message Header	</Msgld>
Proprietary Data	<PrtryData>
Type	<Tp>InsertPHABalance</Tp>
Proprietary Data	<Data>
SSP Proprietary Data	<SspPrtryDt>
PHA Management Identification	<PHAMgmtld>
Country Code	<Ctry>DE</Ctry>
End PHA Management Identification	</PHAMgmtld>
Number of Items	<NbOfItms>2</NbOfItms>
Total Number of Items	<TotNbOfItms>2</TotNbOfItms>
New PHA Balance Value Set	<NewPHABalValSet>
Counterparty Identification	<CtrPtyld>
BIC	<BIC>AAADEFFAAA</BIC>
End Counterparty Identification	</CtrPtyld>
PHA Balance	<PHABal>
Amount	<Amt>100000.05</Amt>
Credit or debit indicator	<CdtDbtInd>CRDT</CdtDbtInd>
Type	<Tp>CLSG</Tp>
Value Date	<ValDt>
Value Date	<Dt>2007-08-13</Dt>
End Value Date	</ValDt>
End PHA Balance	</PHABal>
End New PHA Balance Value Set	</NewPHABalValSet>
End of SSP Proprietary Data	</SspPrtryDt>
End of Proprietary Data	</Data>
End of Proprietary Data	</PrtryData>
End proprietary message	</PrtryMsg>

6. 9. 7 ReturnAccount

Cash Management Standard

ReturnAccount_RM

Scope: The Return Account Message is used to return information about the fulfilment of the minimum reserve of a specified participant. Depending on the selected participant, the following information will be returned: (i) for direct minimum reserve maintainers: the value of the minimum reserve, the end of day balance, the running average and the adjustment balance; (ii) for intermediaries (direct maintainers which manage the reserve requirement also for one or more indirect maintainers): the value of the minimum reserve (including the list of the minimum reserve due by the connected indirect maintainers), the end of day balance, the running average and the adjustment balance; (iii) for participants which are members of a pool of accounts of a MFI: the value of the minimum reserve, the end of day balance of all the accounts which belong to the same pool, the running average and the adjustment balance; (iv) for indirect minimum reserve maintainers: the value of the minimum reserve requirement only. The connected request is performed through a Get Account Message.

<camt.004.001.xx>

Structure:

Message Type	<RtrAcct>
Message Header	<MsgHdr>
Message Identification	<MsgId></MsgId>
Original Business Query	<OrgnlBizQry>
Message Identification	<MsgId></MsgId>
End of Original Business Query	</OrgnlBizQry>
End of Message Header	</MsgHdr>
AccountOrOperationalErrorChoice	<RptOrErr>
Choice	xorAcctOprlErr
AccountReport	<AcctRpt>
Account Identification	<AcctId>
GenericAccountIdentification	<Othr>
AccountIdentification	<Id></Id>
End of GenericAccountIdentification	</Othr>
End of Account Identification	</AcctId>
Account information (or business error)	<AcctOrErr>
Account Identification	<Acct>
CashAccountType	<Tp>
ExternalCashAccountTypeCode	<Cd></Cd>
End of CashAccountType	</Tp>
MultilateralBalance	<MulBal>
Amount	<Amt></Amt>
Credit or debit indicator	<CdtDbtInd></CdtDbtInd>
BalanceTypeCode	<Tp>
BalanceTypeCode	<Cd></Cd>
End balance type choice	</Tp>
Value Date	<ValDt>
Date Time	<DtTm></DtTm>
End Value Date	</ValDt>
End of MultilateralBalance	</MulBal>
End of Account	</Acct>
End of Account or Business Error	</AcctOrErr>
End of AccountReport	</AcctRpt>
Operational Error	<OprlErr>
Error handling	<Err>
Proprietary error code	<Prtry></Prtry>
End error handling	</Err>
Description	<Desc></Desc>

End of Operational Error	</OprlErr>
End choice	/xorBizRptOprlErr
End of AccountOrOperationalErrorChoice	</RptOrErr>
End of Message Type	</RtrAcct>

Attributes:

name of attribute	format	short description	description
<RtrAcct>		Message Type Mandatory	Validation: [1..1]
<MsgHdr>		Message Header Mandatory	Set of characteristics specific to the message Validation: [1..1]
<MsgId>-</MsgId>	35x	Message Identification Mandatory	Message Identification String of characters that uniquely identifies a message at senders side. Validation: [1..1]
<OrgnlBizQry>		Original Business Query Mandatory	Original Business Query, reference to the query Validation: [1..1]
<MsgId>-</MsgId>	35x	Message Identification Mandatory	Message Identification Validation: [1..1]
</OrgnlBizQry>		End of Original Business Query Mandatory	End of Original Business Query, reference to the query Message identification of the connected request . Validation: [1..1]
</MsgHdr>		End of Message Header Mandatory	Validation: [1..1]
<RptOrErr>		AccountOrOperationalError Choice Mandatory	Validation: [1..1]
xorAcctOprlErr		Choice Mandatory	Validation: [1..1]
<AcctRpt>		AccountReport Mandatory	The following cases are possible: 1) The specified participant is a direct compulsory reserve maintainer (without indirects): only one instance of <AcctRpt> will be present, with data concerning the direct maintainer. 2) The specified participant is a intermediary (direct maintainer with n indirects): <AcctRpt> will be repeated n+1 times; the first instance will refer to the direct maintainer and will contain the total value of the compulsory reserve (sum of the compulsory reserve of the direct maintainer plus the minimum reserve of all its indirects); the following instances will contain specific data (minimum reserve) of the direct maintainer and of each indirect. 3) The specified participant is an indirect maintainer: only one instance of <AcctRpt> will be present, with data concerning the indirect maintainer. 4) The specified participant is a member of a pool of accounts of a MFI (composed of n members): <AcctRpt> will be repeated n+1 times; the first instance will refer to the MFI leader and will the contain the global data of the pool; the following instances will contain data (opening balance) specific for each member of the pool. Validation:

name of attribute	format	short description	description
			[1..n]
<AcctId>		Account Identification Mandatory	Account Identification Validation: [1..1]
<Othr>		GenericAccountIdentification Mandatory	GenericAccountIdentification Validation: [1..1]
<Id>-</Id>	BICFI	AccountIdentification Mandatory	AccountIdentification BIC of the participant to whom data are referred. Validation: [1..1]
</Othr>		End of GenericAccountIdentification Mandatory	End of GenericAccountIdentification Validation: [1..1]
</AcctId>		End of Account Identification Mandatory	Validation: [1..1]
<AcctOrErr>		Account information (or business error) Mandatory	Validation: [1..1]
<Acct>		Account Identification Mandatory	Validation: [1..1]
<Tp>		CashAccountType Optional	CashAccountType Validation: [0..1]
<Cd>-</Cd>	4!c	ExternalCashAccountType Code Mandatory	SSP restricted code list: CACC = Current Account used to post debits and credits when no specific account has been nominated OTHR = Specific code used to identify Proprietary Home Accounts SACC = Settlement Account used to post debit and credit entries, as a result of transactions cleared and settled through a specific clearing and settlement system. Specifies the type of the participant's account used for the fulfillment of the minimum reserve. It will be "CACC" (HAM), "SACC" (RTGS account) or "OTHR" (PHA account) It will not be present in case of indirect maintainers Validation: [1..1]
</Tp>		End of CashAccountType Optional	End of CashAccountType Validation: [0..1]
<MulBal>		MultilateralBalance	

name of attribute	format	short description	description
		Optional	Validation: [0..4]
<Amt>-</Amt>	18d	Amount	Amount . Depending on the content of the tag <Tp> the amount could refer either to: the Opening Balance, the Minimum Reserve, the Adjustment Balance or the Progressive Average.
		Mandatory	Validation: [1..1]
<CdtDbtInd>-</CdtDbtInd>	4!a	Credit or debit indicator	Credit debit indicator. It can be: CRDT (credit) or DBIT (debit).
		Mandatory	Validation: [1..1]
<Tp>		BalanceTypeCode	Nature of the event that has occurred.
		Mandatory	Balance type. It can be: "OPNG" (opening balance) or "CRRT" (current balance). Special case: if the account is no more active, but a balance greater than zero is still present, it will be "CLSG " (closing balance). Validation: [1..1]
<Cd>		BalanceTypeCode	Specifies the nature of the balance, eg, opening balance.
			ADJT= Adjustment Average balance to be held in the settlement account at the end of each day in order to fulfil the reserve due. The approximation will be always made rounding up.
			AVLB = Available Balance of money or securities that is at the disposal of the account owner on the date specified.
			BLCK = Blocked Balance representing the regulatory reserve that a financial institution must have with the account servicing institution, eg, the minimum credit balance a financial institution is to keep with ist Central Bank for mandatory reserve purposes. In some countries, a blocked balance is known as a 'reserve' balance.
			BOOK = Book Balance that is registered in the books of the account servicer.
			CLSG = Closing Balance of the account at the end of the account servicer's business day. It is the sum of the opening balance at the beginning of the day and all entries booked to the account during the account servicer's business day.
			CRDT = Credit Balance representing the sum of all credit entries booked to an account.
			CRRT = Current Balance of the account at a precise moment in time.
			DBIT = Debit Balance representing the sum of all debit entries booked to an account.
			DLOD = DaylightOverdraft Balance representing the intra day overdraft granted by the Central Bank to financial institutions participating in a RTGS system. This balance may vary over time and shall be offset at the end of the day.
			EAST = EligibleAssets Balance representing the potential loan a Central Bank would make in cash if the collateral is pledged, eg,

name of attribute	format	short description	description
		Mandatory	<p>securities available and eligible as collateral with the Central Bank.</p> <p>INTM = Interim Balance calculated in the course of the account servicer's business day, at the time specified, and subject to further changes during the business day. The interim balance is calculated on the basis of booked credit and debit items during the calculation time/period specified.</p> <p>LRLD = LimitRelated Balance of a specific limit value, eg, a bilateral balance is calculated in relation to a given bilateral limit.</p> <p>LTSF= LiquidityTransfer Balance composed of the sum of all liquidity transfers made to or from an account.</p> <p>OPNG = Opening Book balance of the account at the beginning of the account servicer's business day. It always equals the closing book balance from the previous business day. Note: the available balance at the beginning of the account servicer's business day may be different from the closing book balance from the previous business day.</p> <p>PDNG = Pending Balance of securities pending delivery, eg, orders to sell securities have been executed but settlement of the open transactions has not been confirmed.</p> <p>PRAV = ProgressiveAverage Average of the daily balances on the account used to fulfil the reserve requirements calculated from the beginning of the maintenance period.</p> <p>PYMT = Payment Balance representing the sum of entries as a result of payments processing. Entries relating to fees, interest, or other movements not a result of payments sent or received by the account owner are not included.</p> <p>XCRD = ExpectedCredit Balance, composed of booked entries and pending items known at the time of calculation, which projects the end of day credit balance if everything books to the account and no other credit entry is posted.</p> <p>XDBT = ExpectedDebit Balance, composed of booked entries and pending items known at the time of calculation, which projects the end of day debit balance if everything books to the account and no other debit entry is posted.</p> <p>XPCD = Expected Balance, composed of booked entries and pending items known at the time of calculation , which projects the end of day balance if everything is booked on the account and no other entry is posted.</p> <p>*****NOTE = Noted Balance Balance representing the amount that a financial institution has set aside for a specific reason and which is therefore not available</p> <p>Type of amount. It can be: "OPNG" (opening balance); "BLCK" (Minimum Reserve); "ADJT" (Adjustment Balance) "PRAV" (Progressive Average).</p> <p>Validation: [1..1]</p>
</Tp>		Mandatory	<p>End balance type choice</p> <p>Validation: [1..1]</p>
<ValDt>		Value Date	

name of attribute	format	short description	description
		Mandatory	Validation: [0..1]
<DtTm>-</DtTm>	ISODateTime	Date Time	Date and time of the response (with UTC shift) (yyyy-mm-ddThh:mm:ss+ii:nn).
		Mandatory	Validation: [1..1]
</ValDt>		End Value Date	
		Optional	Validation: [0..1]
</MulBal>		End of MultilateralBalance	
		Optional	Validation: [0..4]
</Acct>		End of Account	
		Mandatory	Validation: [1..1]
</AcctOrErr>		End of Account or Business Error	
		Mandatory	Validation: [1..1]
</AcctRpt>		End of AccountReport	
		Mandatory	Validation: [1..n]
<OprlErr>		Operational Error	
		Mandatory	Validation: [1..1]
<Err>		Error handling	
		Mandatory	Validation: [1..1]
<Prtry>-</Prtry>	4x	Proprietary error code	Specification of the error, in free format.
		Mandatory	Validation: [1..1]
</Err>		End error handling	
		Mandatory	Validation: [1..1]
<Desc>-</Desc>	140x	Description	Error description
		Optional	Validation: [0..1]
</OprlErr>		End of Operational Error	End of Operational Error
		Mandatory	Validation: [1..1]
/xorBizRptOprlErr		End choice	Rule description: If BusinessReport is present then OperationalError is not allowed. If BusinessReport is not present, then OperationalError is mandatory.
		Mandatory	Validation:

name of attribute	format	short description	description
</RptOrErr>		End of AccountOrOperationalError Choice	[1..1] Validation: [1..1]
</RtrAcct>		End of Message Type	Validation: [1..1]

Error Codes:

ReturnAccount_RM_1

Scope: A response to a request of information about the fulfilment of the minimum reserve of a direct maintainer without indirects (see Get Account example 1).

Message Type	<RtrAcct>
Message Header	<MsgHdr>
Message Identification	<MsgId>CMCDEFGHIJKLMNOPQRST123456789012345</MsgId>
Original Business Query	<OrgnlBizQry>
Message Identification	<MsgId>RMCDEFGHIJKLMNOPQRST123456789012345</MsgId>
End of Original Business Query	</OrgnlBizQry>
End of Message Header	</MsgHdr>
AccountOrOperationalErrorChoice	<RptOrErr>
AccountReport	<AcctRpt>
Account Identification	<AcctId>
GenericAccountIdentification	<Othr>
AccountIdentification	<Id>BBBBITRRXXX</Id>
End of GenericAccountIdentification	</Othr>
End of Account Identification	</AcctId>
Account information (or business error)	<AcctOrErr>
Account Identification	<Acct>
CashAccountType	<Tp>
ExternalCashAccountTypeCode	<Cd>CACC</Cd>
End of CashAccountType	</Tp>
MultilateralBalance	<MulBal>
Amount	<Amt>1234.56</Amt>
Credit or debit indicator	<CdtDbtInd>CRDT</CdtDbtInd>
BalanceTypeCode	<Tp>
BalanceTypeCode	<Cd>BLCK</Cd>
End balance type choice	</Tp>
Value Date	<ValDt>
Date Time	<DtTm>2008-09-12T15:29:00+00:00</DtTm>
End Value Date	</ValDt>
End of MultilateralBalance	</MulBal>
MultilateralBalance	<MulBal>
Amount	<Amt>1234.56</Amt>
Credit or debit indicator	<CdtDbtInd>CRDT</CdtDbtInd>
BalanceTypeCode	<Tp>
BalanceTypeCode	<Cd>PRAV</Cd>
End balance type choice	</Tp>
Value Date	<ValDt>
Date Time	<DtTm>2008-09-12T15:29:00+00:00</DtTm>
End Value Date	</ValDt>
End of MultilateralBalance	</MulBal>
MultilateralBalance	<MulBal>
Amount	<Amt>1234.56</Amt>
Credit or debit indicator	<CdtDbtInd>CRDT</CdtDbtInd>
BalanceTypeCode	<Tp>
BalanceTypeCode	<Cd>ADJT</Cd>
End balance type choice	</Tp>
Value Date	<ValDt>
Date Time	<DtTm>2008-09-12T15:29:00+00:00</DtTm>
End Value Date	</ValDt>
End of MultilateralBalance	</MulBal>

MultilateralBalance	<MulBal>
Amount	<Amt>1234.56</Amt>
Credit or debit indicator	<CdtDbtInd>CRDT</CdtDbtInd>
BalanceTypeCode	<Tp>
BalanceTypeCode	<Cd>OPNG</Cd>
End balance type choice	</Tp>
Value Date	<ValDt>
Date Time	<DtTm>2008-09-12T15:29:00+00:00</DtTm>
End Value Date	</ValDt>
End of MultilateralBalance	</MulBal>
End of Account	</Acct>
End of Account or Business Error	</AcctOrErr>
End of AccountReport	</AcctRpt>
End of AccountOrOperationalErrorChoice	</RptOrErr>
End of Message Type	</RtrAcct>

ReturnAccount_RM_2

Scope: A response to a request of information about the fulfillment of the minimum reserve of an intermediary (direct maintainer which manages the reserve requirement also for indirect maintainers) (see Get Account example 1).

Message Type	<RtrAcct>
Message Header	<MsgHdr>
Message Identification	<MsgId>ABCDEFGHIJKLMNQRST123456789012345</MsgId>
Original Business Query	<OrgnlBizQry>
Message Identification	<MsgId>RMCDEFGHIJKLMNQRST123456789012345</MsgId>
End of Original Business Query	</OrgnlBizQry>
End of Message Header	</MsgHdr>
AccountOrOperationalErrorChoice	<RptOrErr>
AccountReport	<AcctRpt>
Account Identification	<AcctId>
GenericAccountIdentification	<Othr>
AccountIdentification	<Id>BBBBITRRXXX</Id>
End of GenericAccountIdentification	</Othr>
End of Account Identification	</AcctId>
Account information (or business error)	<AcctOrErr>
Account Identification	<Acct>
CashAccountType	<Tp>
ExternalCashAccountTypeCode	<Cd>CACC</Cd>
End of CashAccountType	</Tp>
MultilateralBalance	<MulBal>
Amount	<Amt>1234.56</Amt>
Credit or debit indicator	<CdtDbtInd>CRDT</CdtDbtInd>
BalanceTypeCode	<Tp>
BalanceTypeCode	<Cd>BLCK</Cd>
End balance type choice	</Tp>
Value Date	<ValDt>
Date Time	<DtTm>2008-09-12T15:29:00+00:00</DtTm>
End Value Date	</ValDt>
End of MultilateralBalance	</MulBal>
End of MultilateralBalance	</MulBal>
MultilateralBalance	<MulBal>
Amount	<Amt>1234.56</Amt>
Credit or debit indicator	<CdtDbtInd>CRDT</CdtDbtInd>
BalanceTypeCode	<Tp>
BalanceTypeCode	<Cd>PRAV</Cd>
End balance type choice	</Tp>
Value Date	<ValDt>
Date Time	<DtTm>2008-09-12T15:29:00+00:00</DtTm>
End Value Date	</ValDt>
End of MultilateralBalance	</MulBal>
MultilateralBalance	<MulBal>
Amount	<Amt>1234.56</Amt>
Credit or debit indicator	<CdtDbtInd>CRDT</CdtDbtInd>
BalanceTypeCode	<Tp>
BalanceTypeCode	<Cd>ADJT</Cd>
End balance type choice	</Tp>
Value Date	<ValDt>
Date Time	<DtTm>2008-09-12T15:29:00+00:00</DtTm>
End Value Date	</ValDt>

End of MultilateralBalance	<MulBal>
MultilateralBalance	<MulBal>
Amount	<Amt>1234.56</Amt>
Credit or debit indicator	<CdtDbtInd>CRDT</CdtDbtInd>
BalanceTypeCode	<Tp>
BalanceTypeCode	<Cd>OPNG</Cd>
End balance type choice	</Tp>
Value Date	<ValDt>
Date Time	<DtTm>2008-09-12T15:29:00+00:00</DtTm>
End Value Date	</ValDt>
End of MultilateralBalance	</MulBal>
End of Account	</Acct>
End of Account or Business Error	</AcctOrErr>
End of AccountReport	</AcctRpt>
AccountReport	<AcctRpt>
Account Identification	<AcctId>
GenericAccountIdentification	<Othr>
AccountIdentification	<Id>BBBITRRXXX</Id>
End of GenericAccountIdentification	</Othr>
End of Account Identification	</AcctId>
Account information (or business error)	<AcctOrErr>
Account Identification	<Acct>
CashAccountType	<Tp>
ExternalCashAccountTypeCode	<Cd>CACC</Cd>
End of CashAccountType	</Tp>
MultilateralBalance	<MulBal>
Amount	<Amt>1000.11</Amt>
Credit or debit indicator	<CdtDbtInd>CRDT</CdtDbtInd>
BalanceTypeCode	<Tp>
BalanceTypeCode	<Cd>BLCK</Cd>
End balance type choice	</Tp>
Value Date	<ValDt>
Date Time	<DtTm>2008-09-12T15:29:00+00:00</DtTm>
End Value Date	</ValDt>
End of Account	</Acct>
End of Account or Business Error	</AcctOrErr>
End of AccountReport	</AcctRpt>
End of AccountOrOperationalErrorChoice	</RptOrErr>
End of Message Type	</RtrAcct>

ReturnAccount_RM_3

Scope: A response to a request of information about the fulfilment of the minimum reserve of a member or a leader of a pool of accounts of a MFI (see Get Account example 1).

Message Type	<RtrAcct>
Message Header	<MsgHdr>
Message Identification	<MsgId>AACDEFGHIJKLMNOPQRST123456789012345</MsgId>
Original Business Query	<OrgnlBizQry>
Message Identification	<MsgId>RMCDEFGHIJKLMNOPQRST123456789012345</MsgId>
End of Original Business Query	</OrgnlBizQry>
End of Message Header	</MsgHdr>
AccountOrOperationalErrorChoice	<RptOrErr>
AccountReport	<AcctRpt>
Account Identification	<AcctId>
GenericAccountIdentification	<Othr>
AccountIdentification	<Id>BBBBITRRXXX</Id>
End of GenericAccountIdentification	</Othr>
End of Account Identification	</AcctId>
Account information (or business error)	<AcctOrErr>
Account Identification	<Acct>
CashAccountType	<Tp>
ExternalCashAccountTypeCode	<Cd>CACC</Cd>
End of CashAccountType	</Tp>
MultilateralBalance	<MulBal>
Amount	<Amt>1234.56</Amt>
Credit or debit indicator	<CdtDbtInd>CRDT</CdtDbtInd>
BalanceTypeCode	<Tp>
BalanceTypeCode	<Cd>BLCK</Cd>
End balance type choice	</Tp>
Value Date	<ValDt>
Date Time	<DtTm>2008-09-12T15:29:00+00:00</DtTm>
End Value Date	</ValDt>
End of MultilateralBalance	</MulBal>
MultilateralBalance	<MulBal>
Amount	<Amt>1234.56</Amt>
Credit or debit indicator	<CdtDbtInd>CRDT</CdtDbtInd>
BalanceTypeCode	<Tp>
BalanceTypeCode	<Cd>PRAV</Cd>
End balance type choice	</Tp>
Value Date	<ValDt>
Date Time	<DtTm>2008-09-12T15:29:00+00:00</DtTm>
End Value Date	</ValDt>
End of MultilateralBalance	</MulBal>
MultilateralBalance	<MulBal>
Amount	<Amt>1234.56</Amt>
Credit or debit indicator	<CdtDbtInd>CRDT</CdtDbtInd>
BalanceTypeCode	<Tp>
BalanceTypeCode	<Cd>ADJT</Cd>
End balance type choice	</Tp>
Value Date	<ValDt>
Date Time	<DtTm>2008-09-12T15:29:00+00:00</DtTm>
End Value Date	</ValDt>
End of MultilateralBalance	</MulBal>

MultilateralBalance	<MulBal>
Amount	<Amt>1234.56</Amt>
Credit or debit indicator	<CdtDbtInd>CRDT</CdtDbtInd>
BalanceTypeCode	<Tp>
BalanceTypeCode	<Cd>OPNG</Cd>
End balance type choice	</Tp>
Value Date	<ValDt>
Date Time	<DtTm>2008-09-12T15:29:00+00:00</DtTm>
End Value Date	</ValDt>
End of MultilateralBalance	</MulBal>
End of Account	</Acct>
End of Account or Business Error	</AcctOrErr>
End of AccountReport	</AcctRpt>
AccountReport	<AcctRpt>
Account Identification	<AcctId>
GenericAccountIdentification	<Othr>
AccountIdentification	<Id>BBBBITRRXX</Id>
End of GenericAccountIdentification	</Othr>
End of Account Identification	</AcctId>
Account information (or business error)	<AcctOrErr>
Account Identification	<Acct>
CashAccountType	<Tp>
ExternalCashAccountTypeCode	<Cd>CACC</Cd>
End of CashAccountType	</Tp>
MultilateralBalance	<MulBal>
Amount	<Amt>1000.00</Amt>
Credit or debit indicator	<CdtDbtInd>CRDT</CdtDbtInd>
BalanceTypeCode	<Tp>
BalanceTypeCode	<Cd>OPNG</Cd>
End balance type choice	</Tp>
Value Date	<ValDt>
Date Time	<DtTm>2008-09-12T15:29:00+00:00</DtTm>
End Value Date	</ValDt>
End of MultilateralBalance	</MulBal>
End of Account	</Acct>
End of Account or Business Error	</AcctOrErr>
End of AccountReport	</AcctRpt>
AccountReport	<AcctRpt>
Account Identification	<AcctId>
GenericAccountIdentification	<Othr>
AccountIdentification	<Id>BBBBITRRXX</Id>
End of GenericAccountIdentification	</Othr>
End of Account Identification	</AcctId>
Account information (or business error)	<AcctOrErr>
Account Identification	<Acct>
CashAccountType	<Tp>
ExternalCashAccountTypeCode	<Cd>CACC</Cd>
End of CashAccountType	</Tp>
MultilateralBalance	<MulBal>
Amount	<Amt>234.56</Amt>
Credit or debit indicator	<CdtDbtInd>CRDT</CdtDbtInd>
BalanceTypeCode	<Tp>

BalanceTypeCode							<Cd>OPNG</Cd>
End balance type choice							</Tp>
Value Date							<ValDt>
Date Time							<DtTm>2008-09-12T15:29:00+00:00</DtTm>
End Value Date							</ValDt>
End of MultilateralBalance							</MulBal>
End of Account							</Acct>
End of Account or Business Error							</AcctOrErr>
End of AccountReport							</AcctRpt>
End of AccountOrOperationalErrorChoice							</RptOrErr>
End of Message Type							</RtrAcct>

ReturnAccount_RM_4

Scope: A response to a request of information about the fulfilment of the minimum reserve of an indirect maintainer (see Get Account example 1).

Message Type	<RtrAcct>
Message Header	<MsgHdr>
Message Identification	<MsgId>AACDEFGHIJKLMNOPQRST123456789012345</MsgId>
Original Business Query	<OrgnlBizQry>
Message Identification	<MsgId>RMCDEFGHIJKLMNOPQRST123456789012345</MsgId>
End of Original Business Query	</OrgnlBizQry>
End of Message Header	</MsgHdr>
AccountOrOperationalErrorChoice	<RptOrErr>
AccountReport	<AcctRpt>
Account Identification	<AcctId>
GenericAccountIdentification	<Othr>
AccountIdentification	<Id>BBBBITRRXXX</Id>
End of GenericAccountIdentification	</Othr>
End of Account Identification	</AcctId>
Account information (or business error)	<AcctOrErr>
Account Identification	<Acct>
MultilateralBalance	<MulBal>
Amount	<Amt>1234.56</Amt>
Credit or debit indicator	<CdtDbtInd>CRDT</CdtDbtInd>
BalanceTypeCode	<Tp>
BalanceTypeCode	<Cd>BLCK</Cd>
End balance type choice	</Tp>
Value Date	<ValDt>
Date Time	<DtTm>2008-09-12T15:29:00+00:00</DtTm>
End Value Date	</ValDt>
End of MultilateralBalance	</MulBal>
End of Account	</Acct>
End of Account or Business Error	</AcctOrErr>
End of AccountReport	</AcctRpt>
End of AccountOrOperationalErrorChoice	</RptOrErr>
End of Message Type	</RtrAcct>

6. 9. 8 ReturnCompulsoryReserve (for CBs only)

SSP Proprietary Messages

ReturnCompulsoryReserve_RM

Scope: The Return Compulsory Reserve Message is used to return to NCBs information about the value of the minimum reserve of all the participants belonging to the requesting NCB. The connected request is performed through a Get Compulsory Reserve Message.

<camt.998.001.xx>

Structure:

Name Proprietary message	<PrtryMsg>
Message Header	<MsgHdr>
Message Identification	<MsgId></MsgId>
End of Message Header	</MsgHdr>
Related	<Rltd>
Reference	<Ref></Ref>
End of Related	</Rltd>
Proprietary Data	<PrtryData>
Type	<Tp>ReturnCompulsoryReserve</Tp>
Proprietary Data	<Data>
SSP Proprietary Data	<SspPrtryDt>
Choice	xorBizRptOprlErr
BusinessReport	<BizRpt>
AccountReport	<AcctRpt>
Account Identification	<AcctId>
BIC	<BIC></BIC>
End of Account Identification	</AcctId>
Account Identification	<Acct>
MultilateralBalance	<MulBal>
Amount	<Amt></Amt>
Credit or debit indicator	<CdtDbtInd></CdtDbtInd>
Type	<Tp></Tp>
Maintenance Period	<MntncPrd>
Start Date	<FrDt></FrDt>
End Date	<ToDt></ToDt>
End Manteinance Period	</MntncPrd>
End of MultilateralBalance	</MulBal>
End of Account	</Acct>
End of AccountReport	</AcctRpt>
End of BusinessReport	</BizRpt>
Operational Error	<OprlErr>
Error handling	<Err>
Proprietary error code	<Prtry></Prtry>
End error handling	</Err>
Description	<Desc></Desc>
End of Operational Error	</OprlErr>
End of choice	/xorBizRptOprlErr
End of SSP Proprietary Data	</SspPrtryDt>
End of Proprietary Data	</Data>
End of Proprietary Data	</PrtryData>
End proprietary message	</PrtryMsg>

Attributes:

name of attribute	format	short description	description
<PrtryMsg>		Name Proprietary message Mandatory	Validation: [1..1]
<MsgHdr>		Message Header Mandatory	Set of characteristics specific to the message Validation: [1..1]
<MsgId>-</MsgId>	35x	Message Identification Mandatory	Message Identification String of characters that uniquely identifies a message at senders side. Validation: [1..1]
</MsgHdr>		End of Message Header Mandatory	Validation: [1..1]
<Rltd>		Related Mandatory	References a previously received message. Validation: [1..1]
<Ref>-</Ref>	35x	Reference Mandatory	Unique and unambiguous reference Message identification of the connected request . Validation: [1..1]
</Rltd>		End of Related Mandatory	End of Related Validation: [1..1]
<PrtryData>		Proprietary Data Mandatory	Proprietary Data Validation: [1..1]
<Tp>-</Tp>	35x	Type Mandatory	It will be ReturnCompulsoryReserve Validation: [1..1]
<Data>		Proprietary Data Mandatory	Proprietary data content Validation: [1..1]
<SspPrtryDt>		SSP Proprietary Data Mandatory	SSP Proprietary Data Validation: [1..1]
xorBizRptOprlErr		Choice Mandatory	Choice amongst BizRpt and OprlErr Validation: [1..1]
<BizRpt>		BusinessReport Mandatory	Validation: [1..1]

name of attribute	format	short description	description
<AcctRpt>		AccountReport	This section will be repeated n times, one for each participant of the requesting NCB.
		Mandatory	Validation: [1..n]
<AcctId>		Account Identification	
		Mandatory	Validation: [1..1]
<BIC>-</BIC>	11x	BIC	BIC of the participant to whom data are referred.
		Mandatory	Validation: [1..1]
</AcctId>		End of Account Identification	
		Mandatory	Validation: [1..1]
<Acct>		Account Identification	
		Mandatory	Validation: [1..1]
<MulBal>		MultilateralBalance	
		Mandatory	Validation: [1..1]
<Amt>-</Amt>	18d	Amount	Amount of minimum reserve .
		Mandatory	Validation: [1..1]
<CdtDbtInd>-</CdtDbtInd>	4!a	Credit or debit indicator	Credit debit indicator. It will be: CRDT (credit)
		Mandatory	Validation: [1..1]
<Tp>-</Tp>	35x	Type	Type of amount. It will be BLCK (Minimum Reserve)
		Mandatory	Validation: [1..1]
<MntncPrd>		Maintenance Period	
		Optional	Validation: [0..1]
<FrDt>-</FrDt>	DateTime	Start Date	Start date of the maintainance period (yyyy-mm-dd+ii:nn)
		Mandatory	Validation: [1..1]
<ToDt>-</ToDt>	Date	End Date	End date of the maintainance period (yyyy-mm-dd+ii:nn)
		Mandatory	Validation: [1..1]
</MntncPrd>		End Manteinance Period	
		Optional	Validation: [0..1]
</MulBal>		End of MultilateralBalance	
		Mandatory	Validation:

name of attribute	format	short description	description
			[1..4]
</Acct>		End of Account Mandatory	Validation: [1..1]
</AcctRpt>		End of AccountReport Mandatory	Validation: [1..n]
</BizRpt>		End of BusinessReport Mandatory	Validation: [1..1]
<OprlErr>		Operational Error Mandatory	Validation: [1..1]
<Err>		Error handling Mandatory	Validation: [1..1]
<Prtry>-</Prtry>	4x	Proprietary error code Mandatory	Specification of the error, in free format. Validation: [1..1]
</Err>		End error handling Mandatory	Validation: [1..1]
<Desc>-</Desc>	140x	Description Optional	Error description Validation: [0..1]
</OprlErr>		End of Operational Error Mandatory	End of Operational Error Validation: [1..1]
/xorBizRptOprlErr		End of choice Mandatory	Validation: [1..1]
</SspPrtryDt>		End of SSP Proprietary Data Mandatory	End of SSP Proprietary Data Validation: [1..1]
</Data>		End of Proprietary Data Mandatory	Validation: [1..1]
</PrtryData>		End of Proprietary Data Mandatory	End of Proprietary Data Validation: [1..1]
</PrtryMsg>		End proprietary message Mandatory	Validation:

name of attribute	format	short description	description
[1..1]			

Error Codes:

ReturnCompulsory Reserve_RM_1

Scope: A response to a request of information about value of the minimum reserve in a specified period of all the participants of the requesting NCB. (see Get Compulsory Reserve example 1)

Name Proprietary message	<PrtryMsg>
Message Header	<MsgHdr>
Message Identification	<MsgId>RMCDEFGHIJKLMNOPQRST123456789012345-</MsgId>
End of Message Header	</MsgId>
Related	<Rltd>
Message Identification	<Ref>ABCDEFGHIJKLMNQRST123456789012345-</Ref>
End of Related	</Rltd>
Proprietary Data	<PrtryData>
Type	<Tp>ReturnCompulsoryReserve</Tp>
Proprietary Data	<Data>
SSP Proprietary Data	<SspPrtryDt>
BusinessReport	<BizRpt>
AccountReport	<AcctRpt>
Account Identification	<AcctId>
BIC	<BIC>BBBBITRRXX</BIC>
End of Account Identification	</AcctId>
Account Identification	<Acct>
MultilateralBalance	<MulBal>
Amount	<Amt>1234.56</Amt>
Credit or debit indicator	<CdtDbtInd>CRDT</CdtDbtInd>
Type	<Tp>BLCK</Tp>
Maintenance Period	<MntncPrd>
Start Date	<FrDt>2011-10-11+00:00</FrDt>
End Date	<ToDt>2011-11-18+00:00</ToDt>
End Manteinance Period	</MntncPrd>
End of MultilateralBalance	</MulBal>
End of Account	</Acct>
End of AccountReport	</AcctRpt>
AccountReport	<AcctRpt>
Account Identification	<AcctId>
BIC	<BIC>ATALIT22XX</BIC>
End of Account Identification	</AcctId>
Account Identification	<Acct>
MultilateralBalance	<MulBal>
Amount	<Amt>7890.12</Amt>
Credit or debit indicator	<CdtDbtInd>CRDT</CdtDbtInd>
End of Proprietary Data	</Data>
Type	<Tp>BLCK</Tp>
Maintenance Period	<MntncPrd>
Start Date	<FrDt>2011-10-11+00:00</FrDt>
End Date	<ToDt>2011-11-18+00:00</ToDt>
End Manteinance Period	</MntncPrd>
End of MultilateralBalance	</MulBal>
End of Account	</Acct>
End of AccountReport	</AcctRpt>
End of BusinessReport	</BizRpt>
End of SSP Proprietary Data	</SspPrtryDt>
End of Proprietary Data	</PrtryData>
End proprietary message	</PrtryMsg>

6. 9. 9 ReturnPenalty (for CBs only)

SSP Proprietary Messages

ReturnPenalty_RM

Scope: The Return Penalty message is used to return information about penalties for infringement of minimum reserve. The connected request is performed through a Get Penalty Message.

<camt.998.001.xx>

Structure:

Name Proprietary message	<PrtryMsg>
Message Header	<MsgHdr>
Message Identification	<MsgId></MsgId>
End of Message Header	</MsgHdr>
Related	<Rltd>
Reference	<Ref></Ref>
End of Related	</Rltd>
Proprietary Data	<PrtryData>
Type	<Tp>ReturnPenalty</Tp>
Proprietary Data	<Data>
SSP Proprietary Data	<SspPrtryDt>
Choice	xorBizRptOprlErr
BusinessReport	<BizRpt>
Penalty Report	<PnltyRpt>
Penalty Management Identification Details	<PnltyMgmtId>
Type	<Tp></Tp>
Country Code	<Ctry></Ctry>
Counterparty Identification	<CtrPtyId>
BIC	<BIC></BIC>
End Counterparty Identification	</CtrPtyId>
End Penalty Management Identification Details	</PnltyMgmtId>
Maintenance Period	<MntncPrd>
Start Date	<FrDt></FrDt>
End Date	<ToDt></ToDt>
End Manteinance Period	</MntncPrd>
Penalty Status	<PnltySts></PnltySts>
PenaltyType	<PnltyTp></PnltyTp>
PenaltyAmountMethodOne	<FirstAmt></FirstAmt>
PenaltyAmountMethodTwo	<SecondAmt></SecondAmt>
End Penalty Report	</PnltyRpt>
AccountReport	<AcctRpt>
Account Identification	<AcctId>
BIC	<BIC></BIC>
End of Account Identification	</AcctId>
Account Identification	<Acct>
MultilateralBalance	<MulBal>
Amount	<Amt></Amt>
Credit or debit indicator	<CdtDbtInd></CdtDbtInd>
Type	<Tp></Tp>
Value Date Time	<ValDt></ValDt>
End of MultilateralBalance	</MulBal>
End of Account	</Acct>
End of AccountReport	</AcctRpt>
End of BusinessReport	</BizRpt>

OperationalError				<OprlErr>
Error handling				<Err>
Proprietary error code				<Prtry></Prtry>
End error handling				</Err>
Description				<Desc></Desc>
End of Operational Error				</OprlErr>
End of choice				/xorBizRptOprlErr
End of SSP Proprietary Data				</SspPrtryDt>
End of Proprietary Data				</Data>
End of Proprietary Data				</PrtryData>
End proprietary message				</PrtryMsg>

Attributes:

name of attribute	format	short description	description
<PrtryMsg>		Name Proprietary message Mandatory	Validation: [1..1]
<MsgHdr>		Message Header Mandatory	Set of characteristics specific to the message Validation: [1..1]
<MsgId>-</MsgId>	35x	Message Identification Mandatory	Message Identification String of characters that uniquely identifies a message at senders side. Validation: [1..1]
</MsgHdr>		End of Message Header Mandatory	Validation: [1..1]
<Rltd>		Related Mandatory	References a previously received message. Validation: [1..1]
<Ref>-</Ref>	35x	Reference Mandatory	Unique and unambiguous reference Message identification of the connected request . Validation: [1..1]
</Rltd>		End of Related Mandatory	End of Related Validation: [1..1]
<PrtryData>		Proprietary Data Mandatory	Proprietary Data Validation: [1..1]
<Tp>-</Tp>	35x	Type Mandatory	Identifies the type of message. It will be: "ReturnPenalty". Validation: [1..1]
<Data>		Proprietary Data Mandatory	Proprietary data content Validation: [1..1]
<SspPrtryDt>		SSP Proprietary Data Mandatory	SSP Proprietary Data Validation: [1..1]
xorBizRptOprlErr		Choice Mandatory	Choice amongst business report and operational error Validation: [1..1]
<BizRpt>		BusinessReport Mandatory	Validation: [1..n]

name of attribute	format	short description	description
<PnltyRpt>		Penalty Report Mandatory	Validation: [1..1]
<PnltyMgmtId>		Penalty Management Identification Details Mandatory	Validation: [1..1]
<Tp>-</Tp>	35x	Type Mandatory	It will be: "BLCK". Validation: [1..1]
<Ctry>-</Ctry>	21a	Country Code Mandatory	Country Code Country Code of the relevant NCB. Validation: [1..1]
<CtrPtyId>		Counterparty Identification Mandatory	Validation: [1..1]
<BIC>-</BIC>	11x	BIC Mandatory	BIC of the participant to whom data are referred. Validation: [1..1]
</CtrPtyId>		End Counterparty Identification Mandatory	Validation: [1..1]
</PnltyMgmtId>		End Penalty Management Identification Details Mandatory	Validation: [1..1]
<MntncPrd>		Maintenance Period Mandatory	Maintenance period to which data are referred. Validation: [1..1]
<FrDt>-</FrDt>	DateTime	Start Date Mandatory	Start date of the maintenance period (yyyy-mm-dd+ii:nn). Validation: [1..1]
<ToDt>-</ToDt>	Date	End Date Mandatory	End date of the maintenance period (yyyy-mm-dd+ii:nn). Validation: [1..1]
</MntncPrd>		End Manteinance Period Mandatory	Validation: [1..1]
<PnltySts>-</PnltySts>	5x	Penalty Status Mandatory	Status of penalty. It can be: "PAY" (authorized); "WAIT" (waiting); "NOPAY" (cancelled). Validation: [1..1]

name of attribute	format	short description	description
<PnltyTp>-</PnltyTp>	3x	PenaltyType	In case of authorised penalties, specifies the type of penalty the has been authorised. It can be: "ONE" (penalty for simple infringement) or "TWO" (penalty for repeated infringements). Optional Validation: [0..1]
<FirstAmt>-</FirstAmt>	18d	PenaltyAmountMethodOne	Amount of penalty Type 1 (penalty for simple infringement) . Mandatory Validation: [1..1]
<SecondAmt>-</SecondAmt>	18d	PenaltyAmountMethodTwo	Amount of penalty Type 2 (penalty for repeated infringements) . Mandatory Validation: [1..1]
</PnltyRpt>		End Penalty Report	Mandatory Validation: [1..1]
<AcctRpt>		AccountReport	Mandatory Validation: [1..1]
<AcctId>		Account Identification	Account Identification Mandatory Validation: [1..1]
<BIC>-</BIC>	11x	BIC	BIC of the participant to whom data are referred. Mandatory Validation: [1..1]
</AcctId>		End of Account Identification	Mandatory Validation: [1..1]
<Acct>		Account Identification	Mandatory Validation: [1..1]
<MulBal>		MultilateralBalance	Mandatory Validation: [1..n]
<Amt>-</Amt>	18d	Amount	Amount . Depending on the content of the tag <Tp> the amount could refer either to the Minimum Reserve (<Tp>= BLCK) or to the balance average in the relevant maintenance period (<Tp>= PRAV). Mandatory Validation: [1..1]
<CdtDbtInd>-</CdtDbtInd>	4!a	Credit or debit indicator	Credit Debit Indicator. It will be: "CRDT" (credit). Mandatory Validation: [1..1]
<Tp>-</Tp>	35x	Type	Type of amount. It will be: "BLCK" (for Minimum

name of attribute	format	short description	description
		Mandatory	Reserve) or "PRAV" (Progressive Average) for the balance average in the relevant maintenance period. Validation: [1..1]
<ValDt>-</ValDt>	Date	Value Date Time Mandatory	Date and time of the response (with UTC shift) (yyyy-mm-ddThh:mm:ss+ii:nn). Validation: [1..1]
</MulBal>		End of MultilateralBalance Mandatory	Validation: [1..n]
</Acct>		End of Account Mandatory	Validation: [1..1]
</AcctRpt>		End of AccountReport Mandatory	Validation: [1..1]
</BizRpt>		End of BusinessReport Mandatory	Validation: [1..n]
<OprlErr>		OperationalError Mandatory	Indicates an operational error Rule description: If BusinessReport is present then OperationalError is not allowed. If BusinessReport is not present, then OperationalError is mandatory. Specification of the error, in coded form Validation: [1..1]
<Err>		Error handling Mandatory	Validation: [1..1]
<Prtry>-</Prtry>	4x	Proprietary error code Mandatory	Specification of the error, in free format. Validation: [1..1]
</Err>		End error handling Mandatory	Validation: [1..1]
<Desc>-</Desc>	140x	Description Optional	Specification of the error, in free format. Error description Validation: [0..1]
</OprlErr>		End of Operational Error Mandatory	End of Operational Error Validation: [1..1]
/xorBizRptOprlErr		End of choice Mandatory	Validation: [1..1]

name of attribute	format	short description	description
</SspPrtryDt>		End of SSP Proprietary Data Mandatory	End of SSP Proprietary Data Validation: [1..1]
</Data>		End of Proprietary Data Mandatory	Validation: [1..1]
</PrtryData>		End of Proprietary Data Mandatory	End of Proprietary Data Validation: [1..1]
</PrtryMsg>		End proprietary message Mandatory	Validation: [1..1]

Error Codes:

ReturnPenalty_RM_1

Scope: Response to a request of information about penalties related to a specific maintenance period, for all participants of the requesting NCB and all possible status (see GetPenalty example 1)

Name Proprietary message	<PrtryMsg>
Message Header	<MsgHdr>
Message Identification	<MsgId>ABCDEFGHIJKLMNQRST123456789012345</MsgId>
End of Message Header	</MsgHdr>
Related	<Rltd>
Message Identification	<Ref>RMCDEFGHIJKLMNQRST123456789012345</Ref>
End of Related	</Rltd>
Proprietary Data	<PrtryData>
Type	<Tp>ReturnPenalty</Tp>
Proprietary Data	<Data>
SSP Proprietary Data	<SspPrtryDt>
BusinessReport	<BizRpt>
Penalty Report	<PnltyRpt>
Penalty Management Identification Details	<PnltyMgmtId>
Type	<Tp>BLCK</Tp>
Country Code	<Ctry>DE</Ctry>
Counterparty Identification	<CtrPtyId>
BIC	<BIC>AAAADEFFAAA</BIC>
End Counterparty Identification	</CtrPtyId>
End Penalty Management Identification Details	</PnltyMgmtId>
Maintenance Period	<MntncPrd>
Start Date	<FrDt>2007-09-15</FrDt>
End Date	<ToDt>2007-10-23</ToDt>
End Manteinance Period	</MntncPrd>
Penalty Status	<PnltySts>PAY</PnltySts>
PenaltyType	<PnltyTp>ONE</PnltyTp>
PenaltyAmountMethodOne	<FirstAmt>50.00</FirstAmt>
PenaltyAmountMethodTwo	<SecondAmt>500.00</SecondAmt>
End Penalty Report	</PnltyRpt>
AccountReport	<AcctRpt>
Account Identification	<AcctId>
BIC	<BIC>AAAADEFFAAA</BIC>
End of Account Identification	</AcctId>
Account Identification	<Acct>
MultilateralBalance	<MulBal>
Amount	<Amt>10000.00</Amt>
Credit or debit indicator	<CdtDbtInd>CRDT</CdtDbtInd>
Type	<Tp>BLCK</Tp>
Value Date Time	<ValDt>2007-10-25T09:30:47-05:00</ValDt>
End of MultilateralBalance	</MulBal>
MultilateralBalance	<MulBal>
Amount	<Amt>1000.00</Amt>
Credit or debit indicator	<CdtDbtInd>CRDT</CdtDbtInd>
Type	<Tp>PRAV</Tp>
Value Date Time	<ValDt>2007-10-25T09:30:47-05:00</ValDt>
End of MultilateralBalance	</MulBal>
End of Account	</Acct>
End of AccountReport	</AcctRpt>
End of BusinessReport	</BizRpt>

BusinessReport	<BizRpt>
Penalty Report	<PnltyRpt>
Penalty Management Identification Details	<PnltyMgmtld>
Type	<Tp>BLCK</Tp>
Country Code	<Ctry>DE</Ctry>
Counterparty Identification	<CtrPtyld>
BIC	<BIC>BBBBDEFFBBB</BIC>
End Counterparty Identification	</CtrPtyld>
End Penalty Management Identification Details	</PnltyMgmtld>
Maintenance Period	<MntncPrd>
Start Date	<FrDt>2007-09-15</FrDt>
End Date	<ToDt>2007-10-23</ToDt>
End Manteinance Period	</MntncPrd>
Penalty Status	<PnltySts>WAIT</PnltySts>
PenaltyAmountMethodOne	<FirstAmt>100.00</FirstAmt>
PenaltyAmountMethodTwo	<SecondAmt>200.00</SecondAmt>
End Penalty Report	</PnltyRpt>
AccountReport	<AcctRpt>
Account Identification	<Acctld>
BIC	<BIC>BBBBDEFFBBB</BIC>
End of Account Identification	</Acctld>
Account Identification	<Acct>
MultilateralBalance	<MulBal>
Amount	<Amt>50000.00</Amt>
Credit or debit indicator	<CdtDbtInd>CRDT</CdtDbtInd>
Type	<Tp>BLCK</Tp>
Value Date Time	<ValDt>2007-10-25T09:30:47-05:00</ValDt>
End of MultilateralBalance	</MulBal>
MultilateralBalance	<MulBal>
Amount	<Amt>5000.00</Amt>
Credit or debit indicator	<CdtDbtInd>CRDT</CdtDbtInd>
Type	<Tp>PRAV</Tp>
Value Date Time	<ValDt>2007-10-25T09:30:47-05:00</ValDt>
End of MultilateralBalance	</MulBal>
End of Account	</Acct>
End of AccountReport	</AcctRpt>
End of BusinessReport	</BizRpt>
End of SSP Proprietary Data	</SspPrtryDt>
End of Proprietary Data	</Data>
End of Proprietary Data	</PrtryData>
End proprietary message	</PrtryMsg>

6. 9.10 SendPeriodicFlow (for CBs only)

SSP Proprietary Messages

SendPeriodicFlow_RM

Scope: The Send Periodic Flow File is used to send to NCBs, in push mode (FileAct), information on interests to be paid for compulsory reserve and penalties for infringements.

<camt.998.001.xx>

Structure:

Name Proprietary message	<PrtryMsg>
Message Identification	<Msgld>
Reference	<Ref></Ref>
End Message Identification	</Msgld>
Proprietary Data	<PrtryDt>
Type	<Tp>SendPeriodicFlow</Tp>
SSP Proprietary Data	<SspPrtryDt>
Country Code	<Ctry></Ctry>
Maintenance Period	<MntncPrd>
Start Date	<FrDt></FrDt>
End Date	<ToDt></ToDt>
End Maintenance Period	</MntncPrd>
SettlementDate	<RptValDt></RptValDt>
Number of Items	<NbOfItms> </NbOfItms>
Total Number of Items	<TotNbOfItms></TotNbOfItms>
Flow report	<FlowRpt>
Counterparty Identification	<CtrPtyld>
BIC	<BIC></BIC>
End Counterparty Identification	</CtrPtyld>
AccountReport	<AcctRpt>
Account Identification	<Acct>
MultilateralBalance	<MulBal>
Amount	<Amt></Amt>
Credit or debit indicator	<CdtDbtInd></CdtDbtInd>
Type	<Tp></Tp>
End of MultilateralBalance	</MulBal>
End of Account	</Acct>
End of AccountReport	</AcctRpt>
Interest report	<IntrstRpt>
Amount	<Amt></Amt>
End Interest report	</IntrstRpt>
Penalty Report	<PnltyRpt>
PenaltyAmountMethodOne	<FirstAmt></FirstAmt>
PenaltyAmountMethodTwo	<SecondAmt></SecondAmt>
End Penalty Report	</PnltyRpt>
End flow report	</FlowRpt>
End of SSP Proprietary Data	</SspPrtryDt>
End of Proprietary Data	</PrtryDt>
End proprietary message	</PrtryMsg>

Attributes:

name of attribute	format	short description	description
<PrtryMsg>		Name Proprietary message Mandatory	Validation: [1..1]
<MsgId>		Message Identification Mandatory	Message business identification Unique and unambiguous identifier for a message, as assigned by the Sender. This unique identifier can be used for cross-referencing purposes in subsequent messages. Validation: [1..1]
<Ref>-</Ref>	35x	Reference Mandatory	Unique and unambiguous reference String of characters that uniquely identifies a message at senders side. Validation: [1..1]
</MsgId>		End Message Identification Mandatory	Validation: [1..1]
<PrtryDt>		Proprietary Data Mandatory	Proprietary Data Validation: [1..1]
<Tp>-</Tp>	35x	Type Mandatory	Identifies the type of message. It will be: "SendPeriodicFlow". Validation: [1..1]
<SspPrtryDt>		SSP Proprietary Data Mandatory	SSP Proprietary Data Validation: [1..1]
<Ctry>-</Ctry>	2!a	Country Code Mandatory	Country Code Country Code of the NCB. Validation: [1..1]
<MntncPrd>		Maintenance Period Mandatory	Container for the identification of the maintenance period to which data are referred. Validation: [1..1]
<FrDt>-</FrDt>	DateTime	Start Date Mandatory	Start date of the maintenance period (yyyy-mm-dd+ii:nn). Validation: [1..1]
<ToDt>-</ToDt>	Date	End Date Mandatory	End date of the maintenance period (yyyy-mm-dd+ii:nn). Validation: [1..1]
</MntncPrd>		End Maintenance Period Mandatory	Validation:

name of attribute	format	short description	description
			[1..1]
<RptValDt>-</RptValDt>	Date	SettlementDate Mandatory	Settlement date of interests (yyyy-mm-dd+ii:nn) Validation: [1..1]
<NbOfItms>-</NbOfItms>	18n	Number of Items Mandatory	Progressive number of the file (each report can be composed of more than one file) (18.0). Validation: [1..1]
<TotNbOfItms>-</TotNbOfItms>	18n	Total Number of Items Mandatory	Total number of files which form a single report (18.0). Validation: [1..1]
<FlowRpt>		Flow report Mandatory	Validation: [1..n]
<CtrPtyId>		Counterparty Identification Mandatory	Validation: [1..1]
<BIC>-</BIC>	11x	BIC Mandatory	BIC of the participant to whom data are referred. Validation: [1..1]
</CtrPtyId>		End Counterparty Identification Mandatory	Validation: [1..1]
<AcctRpt>		AccountReport Mandatory	Validation: [1..1]
<Acct>		Account Identification Mandatory	Validation: [1..1]
<MulBal>		MultilateralBalance Mandatory	Validation: [2..2]
<Amt>-</Amt>	18d	Amount Mandatory	Amount . Depending on the content of the tag <Tp> the amount could refer either to the Compulsory Reserve (<Tp>= BLCK) or to the balance average in the relevant maintenance period (<Tp>= PRAV). Validation: [1..1]
<CdtDbtInd>-</CdtDbtInd>	4!a	Credit or debit indicator Mandatory	Credit debit indicator. It will be: "CRDT" (credit). Validation: [1..1]
<Tp>-</Tp>	35x	Type	Amount type. It can be: "BLCK" (Compulsory Reserve) or PRAV" (Progressive Average) for the balance average in the relevant maintenance period.

name of attribute	format	short description	description
		Mandatory	Validation: [1..1]
</MulBal>		End of MultilateralBalance	
		Mandatory	Validation: [2..2]
</Acct>		End of Account	
		Mandatory	Validation: [1..1]
</AcctRpt>		End of AccountReport	
		Mandatory	Validation: [1..1]
<IntrstRpt>		Interest report	
		Optional	Validation: [0..1]
<Amt>-</Amt>	18d	Amount	Amount of calculated interests .
		Mandatory	Validation: [1..1]
</IntrstRpt>		End Interest report	
		Optional	Validation: [0..1]
<PnltyRpt>		Penalty Report	Container for information about penalties. It will be present only in case of infringements.
		Optional	Validation: [0..1]
<FirstAmt>-</FirstAmt>	18d	PenaltyAmountMethodOne	Amount of "Penalty Type 1" (penalty in case of simple infringements) .
		Mandatory	Validation: [1..1]
<SecondAmt>-</SecondAmt>	18d	PenaltyAmountMethodTwo	Amount of "Penalty Type 2" (penalty in case of repeated infringements) .
		Mandatory	Validation: [1..1]
</PnltyRpt>		End Penalty Report	
		Optional	Validation: [0..1]
</FlowRpt>		End flow report	
		Mandatory	Validation: [1..n]
</SspPrtryDt>		End of SSP Proprietary Data	End of SSP Proprietary Data
		Mandatory	Validation: [1..1]
</PrtryDt>		End of Proprietary Data	
		Mandatory	Validation: [1..1]

name of attribute	format	short description	description
</PrtryMsg>		End proprietary message Mandatory	Validation: [1..1]

Error Codes:

SendPeriodicFlow_RM_1

Scope: Report on interests to be paid for compulsory reserve and penalties for infringements (last file of the report; whole report composed by 3 files).

Name Proprietary message	<PrtryMsg>
Message Identification	<Msgld>
Reference	<Ref>RMCDEFGHIJKLMNOPQRST123456789012345</Ref>
End Message Identification	</Msgld>
Proprietary Data	<PrtryDt>
Type	<Tp>SendPeriodicFlow</Tp>
SSP Proprietary Data	<SspPrtryDt>
Country Code	<Ctry>DE</Ctry>
Maintenance Period	<MntncPrd>
Start Date	<FrDt>2007-09-15+00:00</FrDt>
End Date	<ToDt>2007-10-15+00:00</ToDt>
End Maintenance Period	</MntncPrd>
SettlementDate	<RptValDt>2007-10-17+00:00</RptValDt>
Number of Items	<NbOfItms>3</NbOfItms>
Total Number of Items	<TotNbOfItms>3</TotNbOfItms>
Flow report	<FlowRpt>
Counterparty Identification	<CtrPtyld>
BIC	<BIC>AAAADEFFAAA</BIC>
End Counterparty Identification	</CtrPtyld>
AccountReport	<AcctRpt>
Account Identification	<Acct>
MultilateralBalance	<MulBal>
Amount	<Amt>12121.20</Amt>
Credit or debit indicator	<CdtDbtInd>CRDT</CdtDbtInd>
Type	<Tp>BLCK</Tp>
End of MultilateralBalance	</MulBal>
MultilateralBalance	<MulBal>
Amount	<Amt>52121.20</Amt>
Credit or debit indicator	<CdtDbtInd>CRDT</CdtDbtInd>
Type	<Tp>PRAV</Tp>
End of MultilateralBalance	</MulBal>
End of Account	</Acct>
End of AccountReport	</AcctRpt>
Interest report	<IntrstRpt>
Amount	<Amt>10.00</Amt>
End Interest report	</IntrstRpt>
End flow report	</FlowRpt>
Flow report	<FlowRpt>
Counterparty Identification	<CtrPtyld>
BIC	<BIC>BBBBDEFFBBB</BIC>
End Counterparty Identification	</CtrPtyld>
AccountReport	<AcctRpt>
Account Identification	<Acct>
MultilateralBalance	<MulBal>
Amount	<Amt>1000.00</Amt>
Credit or debit indicator	<CdtDbtInd>CRDT</CdtDbtInd>
Type	<Tp>BLCK</Tp>
End of MultilateralBalance	</MulBal>
MultilateralBalance	<MulBal>

Amount						<Amt>100.00</Amt>
Credit or debit indicator						<CdtDbtInd>CRDT</CdtDbtInd>
Type						<Tp>PRAV</Tp>
End of MultilateralBalance						</MulBal>
End of Account						</Acct>
End of AccountReport						</AcctRpt>
Interest report						<IntrstRpt>
Amount						<Amt>10.00</Amt>
End Interest report						</IntrstRpt>
Penalty Report						<PnltyRpt>
PenaltyAmountMethodOne						<FirstAmt>10.00</FirstAmt>
PenaltyAmountMethodTwo						<SecondAmt>20.00</SecondAmt>
End Penalty Report						</PnltyRpt>
End flow report						</FlowRpt>
End of SSP Proprietary Data						</SspPrtryDt>
End of Proprietary Data						</PrtryDt>
End proprietary message						</PrtryMsg>

6.10 XML messages related to CM (for CBs only)

6.10. 1 GetAccount (for CBs only)

Cash Management Standard

GetAccount_CM

Scope: The Get Account Message is used by NCBs (on behalf of the account holder) to request information about the balance of the contingency account. This message will be replied by a Return Account Message.

<camt.003.001.xx>

Structure:

Message Type	<GetAcct>
Message Header	<MsgHdr>
Message Identification	<MsgId></MsgId>
End of Message Header	</MsgHdr>
Specification of the query criteria.	<AcctQryDef>
Account Criteria	<AcctCrit>
NewCriteria	<NewCrit>
SearchCriteria	<SchCrit>
CashAccountType	<Tp>
ExternalCashAccountTypeCode	<Cd></Cd>
End of CashAccountType	</Tp>
Account Owner	<AcctOwnr>
Identification	<Id>
OrganisationIdentification	<OrgId>
AnyBICIdentifier	<AnyBIC></AnyBIC>
End of OrganisationIdentification	</OrgId>
End Identification	</Id>
End of Account owner	</AcctOwnr>
End of SearchCriteria	</SchCrit>
End of NewCriteria	</NewCrit>
End Account Criteria	</AcctCrit>
End Account Query Definition	</AcctQryDef>
End of Message Type	</GetAcct>

Attributes:

name of attribute	format	short description	description
<GetAcct>		Message Type	Message name for GetAccount
		Mandatory	Validation: [1..1]
<MsgHdr>		Message Header	Set of characteristics specific to the message
		Mandatory	Validation: [1..1]
<MsgId>-</MsgId>	35x	Message Identification	Message Identification String of characters that uniquely identifies a message at senders side.
		Mandatory	Validation: [1..1]
</MsgHdr>		End of Message Header	
		Mandatory	Validation: [1..1]
<AcctQryDef>		Specification of the query criteria.	
		Mandatory	Validation: [1..1]
<AcctCrit>		Account Criteria	
		Mandatory	Validation: [1..1]
<NewCrit>		NewCriteria	
		Mandatory	Validation: [1..1]
<SchCrit>		SearchCriteria	
		Mandatory	Validation: [1..1]
<Tp>		CashAccountType	CashAccountType
		Mandatory	Validation: [1..1]
<Cd>-</Cd>		ExternalCashAccountType Code	ExternalCashAccountTypeCode SSP restricted code list: CACC = Current Account used to post debits and credits when no specific account has been nominated SACC = Settlement Account used to post debit and credit entries, as a result of transactions cleared and settled through a specific clearing and settlement system. Account type. It must be: "SACC" (settlement account).
		Mandatory	Validation: [1..1]
</Tp>		End of CashAccountType	End of CashAccountType
		Mandatory	Validation: [1..1]

name of attribute	format	short description	description
<AcctOwnr>		Account Owner Optional	Validation: [0..1]
<Id>		Identification Mandatory	Identification Unique and unambiguous identification for the account between the account owner and the account servicer. Validation: [1..1]
<OrgId>		OrganisationIdentification Mandatory	OrganisationIdentification Validation: [1..1]
<AnyBIC>-</AnyBIC>	4!a2!a2!c[3!cAnyBICIdentifier]	Mandatory	AnyBICIdentifier / BIC used on behalf of third parties BIC of the participant to whom data are referred. Validation: [1..1]
</OrgId>		End of OrganisationIdentification Mandatory	End of OrganisationIdentification Validation: [1..1]
</Id>		End Identification Mandatory	Validation: [1..1]
</AcctOwnr>		End of Account owner Optional	Validation: [0..1]
</SchCrit>		End of SearchCriteria Mandatory	Validation: [1..1]
</NewCrit>		End of NewCriteria Mandatory	Validation: [1..1]
</AcctCrit>		End Account Criteria Mandatory	Validation: [1..1]
</AcctQryDef>		End Account Query Definition Mandatory	Validation: [1..1]
</GetAcct>		End of Message Type Mandatory	End of GetAccount Validation: [1..1]

Error Codes:

Order	Error code				Error Text / Validation/ Remark
	SSP	Y-copy	V-shape	XML	
1	H08			H008	Error Text: Requestor unknown Validation: Remark:
2	H07	M7		H007	Error Text: Account not open Validation: Remark:
3	H04	M4	XT16	H004	Error Text: Operation not allowed (e.g. cross border) Validation: Remark:
4	H01		XI01	H001	Error Text: Sender not allowed Validation: Remark:

GetAccount_CM_1

Scope: Request of information about the balance of the contingency account of a participant. The requestor is the NCB of the account holder.

Message Type	<GetAcct>
Message Header	<MsgHdr>
Message Identification	<MsgId>CMCDEFGHIJKLMNOPQRST123456789012345</MsgId>
End of Message Header	</MsgId>
Specification of the query criteria.	<AcctQryDef>
Account Criteria	<AcctCrit>
NewCriteria	<NewCrit>
SearchCriteria	<SchCrit>
CashAccountType	<Tp>
ExternalCashAccountTypeCode	<Cd>SACC</Cd>
End of CashAccountType	</Tp>
Account Owner	<AcctOwnr>
Identification	<Id>
OrganisationIdentification	<OrgId>
AnyBICIdentifier	<AnyBIC>BBBBITRRXX</AnyBIC>
End of OrganisationIdentification	</OrgId>
End Identification	</Id>
End of Account owner	</AcctOwnr>
End of SearchCriteria	</SchCrit>
End of NewCriteria	</NewCrit>
End Account Criteria	</AcctCrit>
End Account Query Definition	</AcctQryDef>
End of Message Type	</GetAcct>

6.10. 2 GetBusinessDayInformation (for CBs only)

Cash Management Standard

GetBusinessDayInformation_CM

Scope: The Get Business Day Information Message is used by NCBs to request information about the status of the Contingency Module. This message will be replied by a Return Business Day Information Message.

<camt.018.001.xx>

Structure:

Message Type	<GetBizDayInf>
Message Header	<MsgHdr>
Message Identification	<MsgId></MsgId>
End of Message Header	</MsgHdr>
End of Messagename for GetBusinessDayInformation	</GetBizDayInf>

Attributes:

name of attribute	format	short description	description
<GetBizDayInf>		Message Type Mandatory	Validation: [1..1]
<MsgHdr>		Message Header Mandatory	Set of characteristics specific to the message Validation: [1..1]
<MsgId>-</MsgId>	35x	Message Identification Mandatory	Message Identification String of characters that uniquely identifies a message at senders side. Validation: [1..1]
</MsgHdr>		End of Message Header Mandatory	Validation: [1..1]
</GetBizDayInf>		End of Messagename for GetBusinessDayInformation Mandatory	Validation: [1..1]

Error Codes:

Order	Error code				Error Text / Validation/ Remark
	SSP	Y-copy	V-shape	XML	
1	H08			H008	Error Text: Requestor unknown Validation: Remark:

GetBusinessDayInformation_CM_1

Scope: Request of information about the status of the Contingency Module.

Message Type	<GetBizDayInf>
Message Header	<MsgHdr>
Message Header	<MsgHdr>
Message Identification	<MsgId>ABCDEFGHIJKLMNQRST123456789012345</MsgId>
End of Messagename for GetBusinessDayInformation	</GetBizDayInf>

6.10. 3 GetTransaction (for CBs only)

Cash Management Standard

GetTransaction_CM

Scope: The Get Transaction Message is used by NCBs to request information about transactions entered during the contingency. The NCB can ask for: 1) a single transaction (identified via TRN sender and date) 2) all the transactions entered during the contingency (or during a specific time range in the contingency); 3) all debit/credit transactions entered during the contingency (or during a specific time range in the contingency) related to a specific participant.

Business Data Compression via delta sets is not supported!

<camt.005.001.xx>

Structure:

Message name for GetTransaction	<GetTx>
Message Header	<MsgHdr>
Message Identification	<MsgId></MsgId>
End of Message Header	</MsgHdr>
Transaction Query Definition	<TxQryDef>
Transaction Criteria	<TxCrit>
NewCriteria	<NewCrit>
SearchCriteria	<SchCrit>
PaymentTo	<PmtTo>
Member Identification	<Mmbld>
Financial Institution Identification	<FinInstnId>
BICFIIdentifier	<BICFI></BICFI>
End of Financial Institution Identification	</FinInstnId>
End Member Identification	</Mmbld>
End PaymentTo	</PmtTo>
Payment From	<PmtFr>
Member Identification	<Mmbld>
Financial Institution Identification	<FinInstnId>
BICFIIdentifier	<BICFI></BICFI>
End of Financial Institution Identification	</FinInstnId>
End of Member Identification	</Mmbld>
End Payment From	</PmtFr>
Payment Search	<PmtSch>
PaymentIdentification	<PmtId>
Short Business Identification	<ShrtBizId>
TransactionIdentification	<TxId></TxId>
Value date	<IntrBkSttlmDt></IntrBkSttlmDt>
Instructing Agent	<InstgAgt>
Financial Institution Identification	<FinInstnId>
BICFIIdentifier	<BICFI></BICFI>
End of Financial Institution Identification	</FinInstnId>
End of Instructing Agent	</InstgAgt>
End Short Business Identification	</ShrtBizId>
EndPaymentIdentification	</PmtId>
RequestedExecutionDate	<ReqdExctnDt>
Date Time Search	<DtTmSch>
DateTimeRange	<DtTmRg>
From Date Time	<FrDtTm></FrDtTm>
To Date Time	<ToDtTm></ToDtTm>
End Date Time Range	</DtTmRg>
End Date Time Search	</DtTmSch>

End of RequestedExecutionDate						</ReqdExctnDt>
Credit or debit indicator						<CdtDbtInd></CdtDbtInd>
End Payment Search						</PmtSch>
End of SearchCriteria						</SchCrit>
End of NewCriteria						</NewCrit>
End Transaction Criteria						</TxCrit>
End Transaction Query Definition						</TxQryDef>
End of Messagename for GetTransaction						</GetTx>

Attributes:

name of attribute	format	short description	description
<GetTx>		Message name for GetTransaction Mandatory	Message name for GetTransaction Validation: [1..1]
<MsgHdr>		Message Header Mandatory	Set of characteristics specific to the message Validation: [1..1]
<MsgId>-</MsgId>	35x	Message Identification Mandatory	Message Identification String of characters that uniquely identifies a message at senders side. Validation: [1..1]
</MsgHdr>		End of Message Header Mandatory	Validation: [1..1]
<TxQryDef>		Transaction Query Definition Mandatory	Validation: [0..1]
<TxCrit>		Transaction Criteria Mandatory	Validation: [1..1]
<NewCrit>		NewCriteria Mandatory	Validation: [1..1]
<SchCrit>		SearchCriteria Mandatory	Validation: [1..1]
<PmtTo>		PaymentTo Optional	When credit transactions related to a specific participant are selected (<CdtDbtInd> = CRDT) this section is used to specify the participant to whom transactions are referred (creditor). Validation: [0..1]
<MmblD>		Member Identification Optional	Validation: [0..1]
<FinInstnId>		Financial Institution Identification Mandatory	Financial Institution Identification Validation: [1..1]
<BICFI>-</BICFI>	4!a2!a2!c3!c	BICFIIdentifier Mandatory	BICFIIdentifier Validation: [1..1]
</FinInstnId>		End of Financial Institution Identification Mandatory	End of Financial Institution Identification Validation:

name of attribute	format	short description	description
			[1..1]
</MmblD>		End Member Identification Optional	Validation: [0..1]
</PmtTo>		End PaymentTo Optional	Validation: [0..1]
<PmtFr>		Payment From Optional	When debit transactions related to a specific participant are selected (<CdtDbtInd> = DBIT), this section is used to specify the participant to whom transactions are referred (debtor). The sequence can be used only once (repetition is not allowed). Validation: [0..1]
<MmblD>		Member Identification Optional	Validation: [0..1]
<FinInstnId>		Financial Institution Identification Mandatory	Financial Institution Identification Validation: [1..1]
<BICFI>-</BICFI>	4!a2!a2!c3!c	BICFIIdentifier Mandatory	BICFIIdentifier Validation: [1..1]
</FinInstnId>		End of Financial Institution Identification Mandatory	End of Financial Institution Identification Validation: [1..1]
</MmblD>		End of Member Identification Optional	Validation: [0..1]
</PmtFr>		End Payment From Optional	Validation: [0..1]
<PmtSch>		Payment Search Optional	Validation: [0..1]
<PmtId>		PaymentIdentification Mandatory	Set of elements to provide further means of referencing a payment transaction This sequence is used when the requestor wants to select a single transaction, identified via sender, TRN and date. If a single transaction is selected, no other selection criteria are allowed. The sequence can be used only once. Validation: [0..1]
<ShrtBizId>		Short Business Identification Mandatory	Validation:

name of attribute	format	short description	description
			[1..1]
<Txld>-</Txld>	35x	TransactionIdentification Mandatory	Unique and unambiguous identification of a payment transaction, as assigned by the originator. The payment transaction reference is used for reconciliation or to link tasks relating to the payment transaction. Transaction identifier, i.e. TRN of the SWIFT input message (first 16 characters of <Msgld> of the input message). Validation: [1..1]
<IntrBkSttlmDt>-</IntrBkSttlmDt>	ISODate	Value date Mandatory	Value date Settlement date (yyyy-mm-dd). Validation: [1..1]
<InstgAgt>		Instructing Agent Mandatory	Instructing Agent Validation: [1..1]
<FinInstnId>		Financial Institution Identification Mandatory	Financial Institution Identification Validation: [1..1]
<BICFI>-</BICFI>	4!a2!a2!c3!c	BICFIIdentifier Mandatory	BICFIIdentifier BIC of the instructing agent (sender of the transaction instruction). Validation: [1..1]
</FinInstnId>		End of Financial Institution Identification Mandatory	End of Financial Institution Identification Validation: [1..1]
</InstgAgt>		End of Instructing Agent Mandatory	End of Instructing Agent Validation: [1..1]
</ShrtBizId>		End Short Business Identification Mandatory	 Validation: [1..1]
</Pmtld>		EndPaymentIdentification Optional	End of Set of elements to reference a payment transaction Validation: [0..1]
<ReqdExctnDt>		RequestedExecutionDate Optional	This sequence is used when the requestor wants to select transactions arrived in CM within a time range. The sequence can be used only once (repetition is not allowed). Validation: [0..1]
<DtTmSch>		Date Time Search Mandatory	 Validation: [1..1]

name of attribute	format	short description	description
<DtTmRg>		DateTimeRange Mandatory	Validation: [1..1]
<FrDtTm>-</FrDtTm>	DateTime	From Date Time Mandatory	Lower bound of the time range (yyyy-mm-ddThh-mm-ss). Validation: [1..1]
<ToDtTm>-</ToDtTm>	DateTime	To Date Time Mandatory	Upper bound of the time range (yyyy-mm-ddThh-mm-ss). Validation: [1..1]
</DtTmRg>		End Date Time Range Mandatory	Validation: [1..1]
</DtTmSch>		End Date Time Search Mandatory	Validation: [1..1]
</ReqdExctnDt>		End of RequestedExecutionDate Optional	Validation: [0..1]
<CdtDbtInd>-</CdtDbtInd>	4!a	Credit or debit indicator Optional	Credit debit indicator. The attribute is mandatory when the user wants to select transactions related to a specific participant. When valorised, it can be: "CRDT" (credit) or "DBIT" (debit). Validation: [0..1]
</PmtSch>		End Payment Search Optional	Validation: [0..1]
</SchCrit>		End of SearchCriteria Mandatory	Validation: [1..1]
</NewCrit>		End of NewCriteria Mandatory	Validation: [1..1]
</TxCrit>		End Transaction Criteria Mandatory	Validation: [1..1]
</TxQryDef>		End Transaction Query Definition Optional	Validation: [0..1]
</GetTx>		End of Messagename for GetTransaction Mandatory	Validation: [1..1]

Error Codes:

Order	Error code				Error Text / Validation/ Remark
	SSP	Y-copy	V-shape	XML	
1	852	B2	XI12	2852	Error Text: Invalid character or invalid numeric value Validation: Remark:
2	H13			H013	Error Text: Requested field missing in input Validation: Remark:
3	H09			H009	Error Text: Parameter logical error <.> Validation: Remark:
4	H08			H008	Error Text: Requestor unknown Validation: Remark:
5	H07	M7		H007	Error Text: Account not open Validation: Remark:
6	H06			H006	Error Text: No data available (e.g. an empty list) Validation: Remark:
7	H04	M4	XT16	H004	Error Text: Operation not allowed (e.g. cross border) Validation: Remark:
8	H01		XI01	H001	Error Text: Sender not allowed Validation: Remark:

GetTransaction_CM_1

Scope: Request of information on all transactions entered during the contingency.

Message name for GetTransaction	<GetTx>
Message Header	<MsgHdr>
Message Identification	<MsgId>ABCDEFGHIJKLMNQRST123456789012345</MsgId>
End of Message Header	</MsgHdr>
End of Message name for GetTransaction	</GetTx>

GetTransaction_CM_2

Scope: Request of information on a single transaction.

Messagename for GetTransaction	<GetTx>
Message Header	<MsgHdr>
Message Identification	<MsgId>CMCDEFGHIJKLMNOPQRST123456789012345</MsgId>
End of Message Header	</MsgHdr>
Transaction Query Definition	<TxQryDef>
Transaction Criteria	<TxCrit>
NewCriteria	<NewCrit>
SearchCriteria	<SchCrit>
Payment Search	<PmtSch>
PaymentIdentification	<PmtId>
Short Business Identification	<ShrtBizId>
TransactionIdentification	<TxId>ABCDEFGHIL123456</TxId>
Value date	<IntrBkSttlmDt>2007-08-13</IntrBkSttlmDt>
Instructing Agent	<InstgAgt>
Financial Institution Identification	<FinInstnId>
BICFIIdentifier	<BICFI>BBCCITRRXX</BICFI>
End of Financial Institution Identification	</FinInstnId>
End of Instructing Agent	</InstgAgt>
End Short Business Identification	</ShrtBizId>
EndPaymentIdentification	</PmtId>
End Payment Search	</PmtSch>
End of SearchCriteria	</SchCrit>
End of NewCriteria	</NewCrit>
End Transaction Criteria	</TxCrit>
End Transaction Query Definition	</TxQryDef>
End of Messagename for GetTransaction	</GetTx>

GetTransaction_CM_3

Scope: Request of information on all credit transactions entered in a specific time range and related to a specific participant.

Messagename for GetTransaction	<GetTx>
Message Header	<MsgHdr>
Message Identification	<MsgId>ABCDEFGHIJKLMNQRST123456789012345</MsgId>
End of Message Header	</MsgHdr>
Transaction Query Definition	<TxQryDef>
Transaction Criteria	<TxCrit>
NewCriteria	<NewCrit>
SearchCriteria	<SchCrit>
Payment From	<PmtFr>
Member Identification	<Mmbld>
Financial Institution Identification	<FinInstnId>
BICFIIdentifier	<BICFI>BBBBIT22XXX</BICFI>
End of Financial Institution Identification	</FinInstnId>
End of Member Identification	</Mmbld>
End Payment From	</PmtFr>
Payment Search	<PmtSch>
RequestedExecutionDate	<ReqdExctnDt>
Date Time Search	<DtTmSch>
DateTimeRange	<DtTmRg>
From Date Time	<FrDtTm>2007-08-13T08:30:00</FrDtTm>
To Date Time	<ToDtTm>2007-08-13T08:50:00</ToDtTm>
End Date Time Range	</DtTmRg>
End Date Time Search	</DtTmSch>
End of RequestedExecutionDate	</ReqdExctnDt>
Credit or debit indicator	<CdtDbtInd>CRDT</CdtDbtInd>
End Payment Search	</PmtSch>
End of SearchCriteria	</SchCrit>
End of NewCriteria	</NewCrit>
End Transaction Criteria	</TxCrit>
End Transaction Query Definition	</TxQryDef>
End of Messagename for GetTransaction	</GetTx>

6.10. 4 LiquidityCreditTransfer (for CBs only)

Cash Management Standard

LiquidityCreditTransfer_CM

Scope: The Liquidity Credit Transfer Message is used by NCBs for the management of the initial liquidity injection in CM and for entering contingency payments. This message will be replied by a Receipt Message Non-Repudiation of Emission (NRE) is supported.

<camt.050.001.xx>

Structure:

Message name for LiquidityCreditTransfer	<LqdyCdtTfr>
Message Header	<MsgHdr>
Message Identification	<MsgId></MsgId>
End of Message Header	</MsgHdr>
LiquidityCreditTransfer1	<LqdyCdtTfr>
CreditorAccount	<CdtrAcct>
Identification	<Id>
GenericAccountIdentification	<Othr>
AccountIdentification	<Id></Id>
End of GenericAccountIdentification	</Othr>
End Identification	</Id>
CashAccountType	<Tp>
ExternalCashAccountTypeCode	<Cd></Cd>
End of CashAccountType	</Tp>
EndCreditorAccount	</CdtrAcct>
Amount	<TrfdAmt>
Amount without currency	<AmtWthtCcy></AmtWthtCcy>
End of Transferred Amount	</TrfdAmt>
DebtorAccount	<DbtrAcct>
Identification	<Id>
GenericAccountIdentification	<Othr>
AccountIdentification	<Id></Id>
End of GenericAccountIdentification	</Othr>
End Identification	</Id>
CashAccountType	<Tp>
ExternalCashAccountTypeCode	<Cd></Cd>
End of CashAccountType	</Tp>
EndDebtorAccount	</DbtrAcct>
End of LiquidityCreditTransfer1	</LqdyCdtTfr>
End message name LiquidityCreditTransfer	</LqdyCdtTfr>

Attributes:

name of attribute	format	short description	description
<LqdyCdtTrf>		Message name for LiquidityCreditTransfer Mandatory	Message name for LiquidityCreditTransfer Validation: [1..1]
<MsgHdr>		Message Header Mandatory	Set of characteristics specific to the message Validation: [1..1]
<MsgId>-</MsgId>	35x	Message Identification Mandatory	Message Identification String of characters that uniquely identifies a message at senders side. The first 16 characters must be unique (TRN) . TRN can be used by the sender to specify the kind of transaction (e.g. CLS, EURO1, etc.). TRN will be reported to the relevant participants through MT940/MT950 and must be consistent with "X SWIFT Character Set", including exceptions as per SWIFT "Message Format Validations Rules" related to field 20 and 21. Validation: [1..1]
</MsgHdr>		End of Message Header Mandatory	Validation: [1..1]
<LqdyCdtTrf>		LiquidityCreditTransfer1 Mandatory	LiquidityCreditTransfer Validation: [1..1]
<CdtrAcct>		CreditorAccount Mandatory	Validation: [1..1]
<Id>		Identification Mandatory	Validation: [1..1]
<Othr>		GenericAccountIdentification Mandatory	GenericAccountIdentification Validation: [1..1]
<Id>-</Id>	BICFI	AccountIdentification Mandatory	AccountIdentification BIC of the account to be credited. Validation: [1..1]
</Othr>		End of GenericAccountIdentification Mandatory	End of GenericAccountIdentification Validation: [1..1]
</Id>		End Identification Mandatory	Validation: [1..1]
<Tp>		CashAccountType Mandatory	CashAccountType Validation:

name of attribute	format	short description	description
			[1..1]
<Cd>-</Cd>		ExternalCashAccountType Code	ExternalCashAccountTypeCode SSP restricted code list: CACC = Current Account used to post debits and credits when no specific account has been nominated SACC = Settlement Account used to post debit and credit entries, as a result of transactions cleared and settled through a specific clearing and settlement system. Account Type. It must be: "SACC" (Settlement Account). Validation: [1..1]
</Tp>		End of CashAccountType	End of CashAccountType Validation: [1..1]
</CdtrAcct>		EndCreditorAccount	Validation: [1..1]
<TrfdAmt>		Amount	Validation: [1..1]
<AmtWthtCcy>- </AmtWthtCcy>	14n	Amount without currency	Amount . Validation: [1..1]
</TrfdAmt>		End of Transferred Amount	Validation: [1..1]
<DbtrAcct>		DebtorAccount	Validation: [1..1]
<Id>		Identification	Validation: [1..1]
<Othr>		GenericAccountIdentificatio n	GenericAccountIdentification Validation: [1..1]
<Id>-</Id>	BICFI	AccountIdentification	AccountIdentification BIC of the account to be debited. Validation: [1..1]
</Othr>		End of GenericAccountIdentificatio n	End of GenericAccountIdentification Validation: [1..1]

name of attribute	format	short description	description
</ld>		End Identification Mandatory	Validation: [1..1]
<Tp>		CashAccountType Mandatory	CashAccountType Validation: [1..1]
<Cd>-</Cd>		ExternalCashAccountType Code Mandatory	ExternalCashAccountTypeCode SSP restricted code list: CACC = Current Account used to post debits and credits when no specific account has been nominated SACC = Settlement Account used to post debit and credit entries, as a result of transactions cleared and settled through a specific clearing and settlement system. Account Type. It must be: "SACC" (Settlement Account). Validation: [1..1]
</Tp>		End of CashAccountType Mandatory	End of CashAccountType Validation: [1..1]
</DbtrAcct>		EndDebtorAccount Mandatory	Validation: [1..1]
</LqdyCdtTrf>		End of LiquidityCreditTransfer1 Mandatory	End of LiquidityCreditTransfer Validation: [1..1]
</LqdyCdtTrf>		End message name LiquidityCreditTransfer Mandatory	End message name LiquidityCreditTransfer Validation: [1..1]

Error Codes:

Order	Error code				Error Text / Validation/ Remark
	SSP	Y-copy	V-shape	XML	
1	H03		XI07	H003	Error Text: Sender not allowed to debit the specified account Validation: Remark:
2	H08			H008	Error Text: Requestor unknown Validation: Remark:
3	H07	M7		H007	Error Text: Account not open Validation: Remark:
4	H04	M4	XT16	H004	Error Text: Operation not allowed (e.g. cross border) Validation: Remark:
5	861	C1	RF01	2861	Error Text: Double input Validation: Remark:

LiquidityCreditTransfer_CM_1

Scope: Initial liquidity injection: transfer from the NCB account in CM (debtor) to the participant account in CM (creditor).

Message name for LiquidityCreditTransfer	<LqdyCdtTrf>
Message Header	<MsgHdr>
Message Identification	<MsgId>LQJCTEFHGHIJKLMNOPQRST12345678900</MsgId>
End of Message Header	</MsgHdr>
LiquidityCreditTransfer1	<LqdyCdtTrf>
CreditorAccount	<CdtrAcct>
Identification	<Id>
GenericAccountIdentification	<Othr>
AccountIdentification	<Id>BBBBITRRXX</Id>
End of GenericAccountIdentification	</Othr>
End Identification	</Id>
CashAccountType	<Tp>
ExternalCashAccountTypeCode	<Cd>SACC</Cd>
End of CashAccountType	</Tp>
EndCreditorAccount	</CdtrAcct>
Amount	<TrfdAmt>
Amount without currency	<AmtWthtCcy>1234.56</AmtWthtCcy>
End of Transferred Amount	</TrfdAmt>
DebtorAccount	<DbtrAcct>
Identification	<Id>
GenericAccountIdentification	<Othr>
AccountIdentification	<Id>BITAITRRXX</Id>
End of GenericAccountIdentification	</Othr>
End Identification	</Id>
CashAccountType	<Tp>
ExternalCashAccountTypeCode	<Cd>SACC</Cd>
End of CashAccountType	</Tp>
EndDebtorAccount	</DbtrAcct>
End of LiquidityCreditTransfer1	</LqdyCdtTrf>
End message name LiquidityCreditTransfer	</LqdyCdtTrf>

LiquidityCreditTransfer_CM_2

Scope: Enter payment: transfer between accounts in CM of different participants (e.g. EURO1 payment).

Message name for LiquidityCreditTransfer	<LqdyCdtTrf>
Message Header	<MsgHdr>
Message Identification	<MsgId>EURO1EFGHIJKLMNOPQRST12345678901</MsgId>
End of Message Header	</MsgHdr>
LiquidityCreditTransfer1	<LqdyCdtTrf>
CreditorAccount	<CdtrAcct>
Identification	<Id>
GenericAccountIdentification	<Othr>
AccountIdentification	<Id>ECBXCCLLXXX</Id>
End of GenericAccountIdentification	</Othr>
End Identification	</Id>
CashAccountType	<Tp>
ExternalCashAccountTypeCode	<Cd>SACC</Cd>
End of CashAccountType	</Tp>
EndCreditorAccount	</CdtrAcct>
Amount	<TrfdAmt>
Amount without currency	<AmtWthtCcy>1234.56</AmtWthtCcy>
End of Transferred Amount	</TrfdAmt>
DebtorAccount	<DbtrAcct>
Identification	<Id>
GenericAccountIdentification	<Othr>
AccountIdentification	<Id>BBBIT22XXX</Id>
End of GenericAccountIdentification	</Othr>
End Identification	</Id>
CashAccountType	<Tp>
ExternalCashAccountTypeCode	<Cd>SACC</Cd>
End of CashAccountType	</Tp>
EndDebtorAccount	</DbtrAcct>
End of LiquidityCreditTransfer1	</LqdyCdtTrf>
End message name LiquidityCreditTransfer	</LqdyCdtTrf>

6.10. 5 ReturnAccount (for CBs only)

Cash Management Standard

ReturnAccount_CM

Scope: The Return Account Message is used to return information about the balance of the contingency account. The connected request is performed by NCBs through a Get Account Message.

<camt.004.001.xx>

Structure:

Message Type	<RtrAcct>
Message Header	<MsgHdr>
Message Identification	<MsgId></MsgId>
Original Business Query	<OrgnBizQry>
Message Identification	<MsgId></MsgId>
End of Original Business Query	</OrgnBizQry>
AccountOrOperationalErrorChoice	<RptOrErr>
Choice	xorAcctOprlErr
AccountReport	<AcctRpt>
Account Identification	<AcctId>
GenericAccountIdentification	<Othr>
Request type	<Id></Id>
End of GenericAccountIdentification	</Othr>
End of Account Identification	</AcctId>
Account information (or business error)	<AcctOrErr>
Account Identification	<Acct>
CashAccountType	<Tp>
ExternalCashAccountTypeCode	<Cd></Cd>
End of CashAccountType	</Tp>
MultilateralBalance	<MulBal>
Amount	<Amt></Amt>
Credit or debit indicator	<CdtDbtInd></CdtDbtInd>
Balance Type choice	<Tp>
BalanceTypeCode	<Cd></Cd>
End balance type choice	</Tp>
Value Date	<ValDt>
Date Time	<DtTm></DtTm>
End Value Date	</ValDt>
End of MultilateralBalance	</MulBal>
End of Account	</Acct>
End of Account or Business Error	</AcctOrErr>
End of AccountReport	</AcctRpt>
Operational Error	<OprlErr>
Error handling	<Err>
Proprietary error code	<Prtry></Prtry>
End error handling	</Err>
Description	<Desc></Desc>
End of Operational Error	</OprlErr>
End of choice	</xorAcctOprlErr>
End of AccountOrOperationalErrorChoice	</RptOrErr>
End of Message Type	</RtrAcct>

Attributes:

name of attribute	format	short description	description
<RtrAcct>		Message Type Mandatory	Validation: [1..1]
<MsgHdr>		Message Header Mandatory	Set of characteristics specific to the message Validation: [1..1]
<MsgId>-</MsgId>	35x	Message Identification Mandatory	Message Identification String of characters that uniquely identifies a message at senders side. Validation: [1..1]
<OrgnlBizQry>		Original Business Query Mandatory	Original Business Query, reference to the query Validation: [1..1]
<MsgId>-</MsgId>	35x	Message Identification Mandatory	Message Identification Validation: [1..1]
</OrgnlBizQry>		End of Original Business Query Mandatory	End of Original Business Query, reference to the query Message identification of the connected request. Validation: [1..1]
<RptOrErr>		AccountOrOperationalError Choice Mandatory	Validation: [1..1]
xorAcctOprlErr		Choice Optional	Validation:
<AcctRpt>		AccountReport Mandatory	Validation: [1..1]
<AcctId>		Account Identification Mandatory	Account Identification Validation: [1..1]
<Othr>		GenericAccountIdentification Mandatory	GenericAccountIdentification Validation: [1..1]
<Id>-</Id>	35x	Request type Mandatory	Request type Fixed value = « ITEM » BIC of the participant to whom data are referred. Validation: [1..1]
</Othr>		End of GenericAccountIdentification	End of GenericAccountIdentification

name of attribute	format	short description	description
		Mandatory	Validation: [1..1]
</AcctId>		End of Account Identification Mandatory	Validation: [1..1]
<AcctOrErr>		Account information (or business error) Mandatory	Validation: [1..1]
<Acct>		Account Identification Mandatory	Account to or from which a cash entry is made Validation: [1..1]
<Tp>		CashAccountType Mandatory	CashAccountType Validation: [1..1]
<Cd>-</Cd>		ExternalCashAccountType Code Mandatory	ExternalCashAccountTypeCode SSP restricted code list: CACC = Current Account used to post debits and credits when no specific account has been nominated SACC = Settlement Account used to post debit and credit entries, as a result of transactions cleared and settled through a specific clearing and settlement system. Account type. It will be: "SACC" (settlement account). Validation: [1..1]
</Tp>		End of CashAccountType Mandatory	End of CashAccountType Validation: [1..1]
<MulBal>		MultilateralBalance Mandatory	Validation: [1..1]
<Amt>-</Amt>	18d	Amount Mandatory	Amount . Validation: [1..1]
<CdtDbtInd>-</CdtDbtInd>	4!a	Credit or debit indicator Mandatory	Credit debit indicator. It can be: "CRDT" (credit) or "DBIT" (debit). Validation: [1..1]
<Tp>		Balance Type choice Mandatory	Validation: [1..1]
<Cd>		BalanceTypeCode	Specifies the nature of the balance, eg, opening balance. ADJT= Adjustment Average balance to be held in the settlement account at

name of attribute	format	short description	description
			<p>the end of each day in order to fulfil the reserve due. The approximation will be always made rounding up.</p> <p>AVLB = Available Balance of money or securities that is at the disposal of the account owner on the date specified.</p> <p>BLCK = Blocked Balance representing the regulatory reserve that a financial institution must have with the account servicing institution, eg, the minimum credit balance a financial institution is to keep with ist Central Bank for mandatory reserve purposes. In some countries, a blocked balance is known as a 'reserve' balance.</p> <p>BOOK = Book Balance that is registered in the books of the account servicer.</p> <p>CLSG = Closing Balance of the account at the end of the account servicer's business day. It is the sum of the opening balance at the beginning of the day and all entries booked to the account during the account servicer's business day.</p> <p>CRDT = Credit Balance representing the sum of all credit entries booked to an account.</p> <p>CRRT = Current Balance of the account at a precise moment in time.</p> <p>DBIT = Debit Balance representing the sum of all debit entries booked to an account.</p> <p>DLOD = DaylightOverdraft Balance representing the intra day overdraft granted by the Central Bank to financial institutions participating in a RTGS system. This balance may vary over time and shall be offset at the end of the day.</p> <p>EAST = EligibleAssets Balance representing the potential loan a Central Bank would make in cash if the collateral is pledged, eg, securities available and eligible as collateral with the Central Bank.</p> <p>INTM = Interim Balance calculated in the course of the account servicer's business day, at the time specified, and subject to further changes during the business day. The interim balance is calculated on the basis of booked credit and debit items during the calculation time/period specified.</p> <p>LRLD = LimitRelated Balance of a specific limit value, eg, a bilateral balance is calculated in relation to a given bilateral limit.</p> <p>LTSF= LiquidityTransfer Balance composed of the sum of all liquidity transfers made to or from an account.</p> <p>OPNG = Opening Book balance of the account at the beginning of the account servicer's business day. It always equals the closing book balance from the previous business day. Note: the available balance at the beginning of the account servicer's business day may be different from the closing book balance from the previous business day.</p> <p>PDNG = Pending Balance of securities pending delivery, eg, orders to sell securities have been executed but settlement of the open transactions has not been confirmed.</p> <p>PRAV = ProgressiveAverage Average of the daily balances on the account used to</p>

name of attribute	format	short description	description
			<p>fulfil the reserve requirements calculated from the beginning of the maintenance period.</p> <p>PYMT = Payment Balance representing the sum of entries as a result of payments processing. Entries relating to fees, interest, or other movements not a result of payments sent or received by the account owner are not included.</p> <p>XCRD = ExpectedCredit Balance, composed of booked entries and pending items known at the time of calculation, which projects the end of day credit balance if everything books to the account and no other credit entry is posted.</p> <p>XDBT = ExpectedDebit Balance, composed of booked entries and pending items known at the time of calculation, which projects the end of day debit balance if everything books to the account and no other debit entry is posted.</p> <p>XPCD = Expected Balance, composed of booked entries and pending items known at the time of calculation , which projects the end of day balance if everything is booked on the account and no other entry is posted.</p> <p>*****NOTE = Noted Balance Balance representing the amount that a financial institution has set aside for a specific reason and which is therefore not available</p> <p>Balance type. It will be: "CRRT" (current balance).</p>
		Mandatory	Validation: [1..1]
</Tp>		End balance type choice	
		Mandatory	Validation: [1..1]
<ValDt>		Value Date	
		Mandatory	Validation: [1..1]
<DtTm>-</DtTm>	ISODateTim e	Date Time	Date and time of the response (yyyy-mm-ddThh:mm:ss).
		Mandatory	Validation: [1..1]
</ValDt>		End Value Date	
		Mandatory	Validation: [1..1]
</MulBal>		End of MultilateralBalance	
		Mandatory	Validation: [1..1]
</Acct>		End of Account	
		Mandatory	Validation: [1..1]
</AcctOrErr>		End of Account or Business Error	
		Mandatory	Validation: [1..1]
</AcctRpt>		End of AccountReport	
		Mandatory	Validation:

name of attribute	format	short description	description
			[1..1]
<OprlErr>		Operational Error	
		Mandatory	Validation: [1..1]
<Err>		Error handling	
		Mandatory	Validation: [1..1]
<Prtry>-</Prtry>	4x	Proprietary error code	Specification of the error, in free format.
		Mandatory	Validation: [1..1]
</Err>		End error handling	
		Mandatory	Validation: [1..1]
<Desc>-</Desc>	140x	Description	Error description
		Optional	Validation: [0..1]
</OprlErr>		End of Operational Error	End of Operational Error
		Mandatory	Validation: [1..1]
/xorAcctOprlErr		End of choice	
		Optional	Validation:
</RptOrErr>		End of AccountOrOperationalError Choice	
		Optional	Validation:
</RtrAcct>		End of Message Type	
		Mandatory	Validation: [1..1]

Error Codes:

ReturnAccount_CM_1

Scope: A response to a request of information about the balance of the contingency account of a participant. (see Get Account example 1)

Message Type	<RtrAcct>
Message Header	<MsgHdr>
Message Identification	<MsgId>ABCDEFGHIJKLMNQRST123456789012345</MsgId>
Original Business Query	<OrgnBizQry>
Message Identification	<MsgId>CMCDEFGHIJKLMNQRST123456789012345</MsgId>
End of Original Business Query	</OrgnBizQry>
AccountOrOperationalErrorChoice	<RptOrErr>
AccountReport	<AcctRpt>
Account Identification	<AcctId>
GenericAccountIdentification	<Othr>
Request type	<Id> BBBBITRRXXX </Id>
End of GenericAccountIdentification	</Othr>
End of Account Identification	</AcctId>
Account information (or business error)	<AcctOrErr>
Account Identification	<Acct>
CashAccountType	<Tp>
ExternalCashAccountTypeCode	<Cd>SACC</Cd>
End of CashAccountType	</Tp>
MultilateralBalance	<MulBal>
Amount	<Amt>1234.56</Amt>
Credit or debit indicator	<CdtDbtInd>CRDT</CdtDbtInd>
Balance Type choice	<Tp>
BalanceTypeCode	<Cd>CRRT</Cd>
End balance type choice	</Tp>
Value Date	<ValDt>
Date Time	<DtTm>2008-09-12T15:29:00</DtTm>
End Value Date	</ValDt>
End of MultilateralBalance	</MulBal>
End of Account	</Acct>
End of Account or Business Error	</AcctOrErr>
End of AccountReport	</AcctRpt>
End of AccountOrOperationalErrorChoice	</RptOrErr>
End of Message Type	</RtrAcct>

6.10. 6 ReturnBusinessDayInformation (for CBs only)

Cash Management Standard

ReturnBusinessDayInformation_CM

Scope: The Return Business Day Information Message is used to return to NCBs information about the status of the Contingency Module. The connected request is performed through a Get Business Day Information Message.

<camt.019.001.xx>

Structure:

Message name for ReturnBusinessDayInformation	<RtrBizDayInf>
Message Header	<MsgHdr>
Message Identification	<MsgId></MsgId>
Original Business Query	<OrgnBizQry>
Message Identification	<MsgId></MsgId>
End of Original Business Query	</OrgnBizQry>
End of Message Header	</MsgHdr>
BusinessDayReportOrErrorChoice	<RptOrErr>
Choice	xorBizRptOprlErr
BusinessReport	<BizRpt>
SystemIdentification	<SysId>
Country Code	<Ctry></Ctry>
End of SystemIdentification	</SysId>
BusinessDayReportOrErrorChoice	<BizDayOrErr>
Business Day Information	<BizDayInf>
System Status	<SysSts>
SystemStatus	<Sts>
SystemStatusCode	<Cd></Cd>
End of SystemStatus	</Sts>
Validity Time	<VldtyTm>
From Date Time	<FrDtTm></FrDtTm>
End Validity Time	</VldtyTm>
End System Status	</SysSts>
End Business Day Information	</BizDayInf>
End of BusinessDayReportOrErrorChoice	</BizDayOrErr>
End of BusinessReport	</BizRpt>
Operational Error	<OprlErr>
Error handling	<Err>
Proprietary error code	<Prtry></Prtry>
End error handling	</Err>
Description	<Desc></Desc>
End of Operational Error	</OprlErr>
End of choice	/xorBizRptOprlErr
End of BusinessDayReportOrErrorChoice	</RptOrErr>
End Message Type	</RtrBizDayInf>

Attributes:

name of attribute	format	short description	description
<RtrBizDayInf>		Message name for ReturnBusinessDayInformation Mandatory	Validation: [1..1]
<MsgHdr>		Message Header Mandatory	Set of characteristics specific to the message Validation: [1..1]
<MsgId>-</MsgId>	35x	Message Identification Mandatory	Message Identification String of characters that uniquely identifies a message at senders side. Validation: [1..1]
<OrgnlBizQry>		Original Business Query Mandatory	Original Business Query, reference to the query Validation: [1..1]
<MsgId>-</MsgId>	35x	Message Identification Mandatory	Message Identification Validation: [1..1]
</OrgnlBizQry>		End of Original Business Query Mandatory	End of Original Business Query, reference to the query Message identification of the connected request . Validation: [1..1]
</MsgHdr>		End of Message Header Mandatory	Validation: [1..1]
<RptOrErr>		BusinessDayReportOrError Choice Mandatory	Validation: [1..1]
xorBizRptOprlErr		Choice Mandatory	Choice amongst BizRpt and OprlErr Validation: [1..1]
<BizRpt>		BusinessReport Mandatory	Validation: [1..1]
<SysId>		SystemIdentification Mandatory	Validation: [1..1]
<Ctry>-</Ctry>	2!a	Country Code Mandatory	Country Code Country Code of the requesting NCB. Validation: [1..1]
</SysId>		End of SystemIdentification Mandatory	Validation:

name of attribute	format	short description	description
			[1..1]
<BizDayOrErr>		BusinessDayReportOrError Choice Mandatory	Validation: [1..1]
<BizDayInf>		Business Day Information Mandatory	Validation: [1..1]
<SysSts>		System Status Mandatory	Validation: [1..1]
<Sts>		SystemStatus Mandatory	Status of the system. It can be: "ACTV" (active); "SUSP" (locked); "CLSG" (closing) or "CLSD" (closed). Validation: [1..1]
<Cd>-</Cd>		SystemStatusCode Mandatory	Validation: [1..1]
</Sts>		End of SystemStatus Mandatory	Validation: [1..1]
<VldtyTm>		Validity Time Mandatory	Validation: [1..1]
<FrDtTm>-</FrDtTm>	DateTime	From Date Time Mandatory	Current CM date and time (yyyy-mm-ddThh:mm:ss). Validation: [1..1]
</VldtyTm>		End Validity Time Mandatory	Validation: [1..1]
</SysSts>		End System Status Mandatory	Validation: [1..1]
</BizDayInf>		End Business Day Information Mandatory	Validation: [1..1]
</BizDayOrErr>		End of BusinessDayReportOrError Choice Mandatory	Validation: [1..1]
</BizRpt>		End of BusinessReport Mandatory	Validation: [1..1]
<OprlErr>		Operational Error	

name of attribute	format	short description	description
		Mandatory	Validation: [1..1]
<Err>		Error handling Mandatory	Validation: [1..1]
<Prtry>-</Prtry>	4x	Proprietary error code Mandatory	Specification of the error, in free format. Validation: [1..1]
</Err>		End error handling Mandatory	Validation: [1..1]
<Desc>-</Desc>	140x	Description Optional	Error description Validation: [0..1]
</OprlErr>		End of Operational Error Mandatory	End of Operational Error Validation: [1..1]
/xorBizRptOprlErr		End of choice Mandatory	Validation: [1..1]
</RptOrErr>		End of BusinessDayReportOrError Choice Mandatory	Validation: [1..1]
</RtrBizDayInf>		End Message Type Mandatory	Validation: [1..1]

Error Codes:

ReturnBusinessDayInformation_CM_1

Scope: Response to a request of information about the status of Contingency Module (see GetBusinessDayInformation example 1).

MessageName fo ReturnBusinessDayInformation	<RtrBizDayInf>
Message Header	<MsgHdr>
Message Identification	<MsgId>AACDEFGHIJKLMNOPQRST123456789012345</MsgId>
Original Business Query	<OrgnlBizQry>
Message Identification	<MsgId>ABCDEFGHIJKLMNOPQRST123456789012345</MsgId>
End of Original Business Query	</OrgnlBizQry>
End of Message Header	</MsgHdr>
BusinessDayReportOrErrorChoice	<RptOrErr>
BusinessReport	<BizRpt>
SystemIdentification	<SysId>
Country Code	<Ctry>IT</Ctry>
End of SystemIdentification	</SysId>
BusinessDayReportOrErrorChoice	<BizDayOrErr>
Business Day Information	<BizDayInf>
System Status	<SysSts>
SystemStatus	<Sts>
SystemStatusCode	<Cd>ACTV</Cd>
End of SystemStatus	</Sts>
Validity Time	<VldtyTm>
From Date Time	<FrDtTm>2001-09-12T09:29:00</FrDtTm>
End Validity Time	</VldtyTm>
End System Status	</SysSts>
End Business Day Information	</BizDayInf>
End of BusinessDayReportOrErrorChoice	</BizDayOrErr>
End of BusinessReport	</BizRpt>
End of BusinessDayReportOrErrorChoice	</RptOrErr>
End Message Type	</RtrBizDayInf>

6.10. 7 ReturnTransaction (for CBs only)

Cash Management Standard

ReturnTransaction_CM

Scope: The Return Transaction Message is used to return to NCBs information about transactions entered in contingency. The connected request is performed through a Get Transaction Message.

<camt.006.001.xx>

Structure:

Message name for Return Transaction	<RtrTx>
Message Header	<MsgHdr>
Message Identification	<MsgId></MsgId>
Original Business Query	<OrgnBizQry>
Message Identification	<MsgId></MsgId>
End of Original Business Query	</OrgnBizQry>
End of Message Header	</MsgHdr>
BusinessReportOrErrorChoice	<RptOrErr>
Choice	xorBizRptOprlErr
BusinessReport	<BizRpt>
TransactionReport	<TxRpt>
PaymentIdentification	<PmtId>
ProprietaryId	<PrtryId></PrtryId>
EndPaymentIdentification	</PmtId>
TransactionOrErrorChoice	<TxOrErr>
Transaction	<Tx>
PaymentTo	<PmtTo>
Member Identification	<Mmbld>
Financial Institution Identification	<FinInstnId>
BICFIIdentifier	<BICFI></BICFI>
End of Financial Institution Identification	</FinInstnId>
End Member Identification	</Mmbld>
End PaymentTo	</PmtTo>
Payment From	<PmtFr>
Member Identification	<Mmbld>
Financial Institution Identification	<FinInstnId>
BICFIIdentifier	<BICFI></BICFI>
End of Financial Institution Identification	</FinInstnId>
End Member Identification	</Mmbld>
End Payment From	</PmtFr>
Credit or debit indicator	<CdtDbtInd></CdtDbtInd>
Payment	<Pmt>
RequestedExecutionDate	<ReqdExctnDt>
Date Time	<DtTm></DtTm>
End of RequestedExecutionDate	</ReqdExctnDt>
PaymentStatus	<Sts>
BalanceTypeCode	<Cd>
Choice	xorFnIStsPdgSts
PendingStatus	<Pdg></Pdg>
FinalStatus	<FnI></FnI>
End of choice	/xorFnIStsPdgSts
End of PaymentStatusCode	</Cd>
Date Time	<DtTm>
Date Time	<DtTm></DtTm>

End of DateTime	</DtTm>
Reason	<Rsn>
ProprietaryStatusJustification	<PrtryRjctn>
Proprietary Status Reason	<PrtryStsRsn></PrtryStsRsn>
Reason	<Rsn></Rsn>
End of ProprietaryStatusJustification	</PrtryRjctn>
End of Reason	</Rsn>
End of PaymentStatus	</Sts>
Instructed Amount	<InstdAmt>
Amount without currency	<AmtWthtCcy></AmtWthtCcy>
End Instructed Amount	</InstdAmt>
ProcessingValidityTime	<PrcgVldtyTm>
From Date Time	<FrDtTm></FrDtTm>
End Processing Validity Time	</PrcgVldtyTm>
TransactionIdentification	<Txld></Txld>
End Payment	</Pmt>
End ofTransaction	</Tx>
End of TransactionOrErrorChoice	</TxOrErr>
End Transaction Report	</TxRpt>
End of BusinessReport	</BizRpt>
Operational Error	<OprlErr>
Error handling	<Err>
Proprietary error code	<Prtry>ABC9</Prtry>
End error handling	</Err>
Description	<Desc></Desc>
End of Operational Error	</OprlErr>
End of choice	/xorBizRptOprErr
End of BusinessReportOrErrorChoice	</RptOrErr>
End messagename ReturnTransaction	</RtrTx>

Attributes:

name of attribute	format	short description	description
<RtrTx>		Message name for Return Transaction Mandatory	Message name for Return Transaction Validation: [1..1]
<MsgHdr>		Message Header Mandatory	Set of characteristics specific to the message Validation: [1..1]
<MsgId>-</MsgId>	35x	Message Identification Mandatory	Message Identification String of characters that uniquely identifies a message at senders side. Validation: [1..1]
<OrgnlBizQry>		Original Business Query Mandatory	Original Business Query, reference to the query Validation: [1..1]
<MsgId>-</MsgId>	35x	Message Identification Mandatory	Message Identification Validation: [1..1]
</OrgnlBizQry>		End of Original Business Query Mandatory	End of Original Business Query, reference to the query Message identification of the connected request . Validation: [1..1]
</MsgHdr>		End of Message Header Mandatory	Validation: [1..1]
<RptOrErr>		BusinessReportOrErrorChoice Mandatory	Validation: [1..1]
xorBizRptOprlErr		Choice Mandatory	Choice amongst BizRpt e OprlErr Validation: [1..1]
<BizRpt>		BusinessReport Mandatory	Validation: [1..1]
<TxRpt>		TransactionReport Mandatory	Validation: [1..n]
<PmtId>		PaymentIdentification Mandatory	Set of elements to provide further means of referencing a payment transaction Validation: [1..1]
<PrtryId>-</PrtryId>	43x	ProprietaryId	ProprietaryId Internal transfer identifier. Unique and unambiguous identifier of a transaction, generated by CM. Digits from 10 to 20 of the internal transfer identifier identify the BIC

name of attribute	format	short description	description
		Mandatory	of the sender of the transaction . Validation: [1..1]
</PmtId>		EndPaymentIdentification Mandatory	End of Set of elements to reference a payment transaction Validation: [1..1]
<TxOrErr>		TransactionOrErrorChoice Mandatory	Validation: [1..1]
<Tx>		Transaction Mandatory	Validation: [1..1]
<PmtTo>		PaymentTo Mandatory	Validation: [1..1]
<Mmbld>		Member Identification Mandatory	Validation: [1..1]
<FinInstnId>		Financial Institution Identification Mandatory	Financial Institution Identification Validation: [1..1]
<BICFI>--</BICFI>	4!a2!a2!c3!c	BICFIIdentifier Mandatory	BICFIIdentifier BIC of the creditor. Validation: [1..1]
</FinInstnId>		End of Financial Institution Identification Mandatory	End of Financial Institution Identification Validation: [1..1]
</Mmbld>		End Member Identification Mandatory	Validation: [1..1]
</PmtTo>		End PaymentTo Mandatory	Validation: [1..1]
<PmtFr>		Payment From Mandatory	Validation: [1..1]
<Mmbld>		Member Identification Mandatory	Validation: [1..1]
<FinInstnId>		Financial Institution Identification Mandatory	Financial Institution Identification Validation: [1..1]

name of attribute	format	short description	description
<BICFI>-</BICFI>	4!a2!a2!c3!c	BICFIIdentifier Mandatory	BICFIIdentifier BIC of the debtor. Validation: [1..1]
</FinInstnId>		End of Financial Institution Identification Mandatory	End of Financial Institution Identification Validation: [1..1]
</Mmbld>		End Member Identification Mandatory	Validation: [1..1]
</PmtFr>		End Payment From Mandatory	Validation: [1..1]
<CdtDbtInd>-</CdtDbtInd>	4!a	Credit or debit indicator Optional	Credit debit indicator. It will be: "CRDT" (credit) or "DBIT" (debit). Validation: [0..1]
<Pmt>		Payment Mandatory	Validation: [1..1]
<ReqdExctnDt>		RequestedExecutionDate Mandatory	Validation: [1..1]
<DtTm>-</DtTm>	ISODateTime	Date Time Mandatory	Specifies when the transaction is arrived in CM (yyyy-mm-ddThh:mm:ss). Validation: [1..1]
</ReqdExctnDt>		End of RequestedExecutionDate Mandatory	Validation: [1..1]
<Sts>		PaymentStatus Mandatory	Validation: [1..1]
<Cd>		BalanceTypeCode	Specifies the nature of the balance, eg, opening balance. ADJT= Adjustment Average balance to be held in the settlement account at the end of each day in order to fulfil the reserve due. The approximation will be always made rounding up. AVLB = Available Balance of money or securities that is at the disposal of the account owner on the date specified. BLCK = Blocked Balance representing the regulatory reserve that a financial institution must have with the account servicing institution, eg, the minimum credit balance a financial institution is to keep with ist Central Bank for mandatory reserve purposes. In some countries, a blocked balance is known as a 'reserve' balance.

name of attribute	format	short description	description
			<p>BOOK = Book Balance that is registered in the books of the account servicer.</p>
			<p>CLSG = Closing Balance of the account at the end of the account servicer's business day. It is the sum of the opening balance at the beginning of the day and all entries booked to the account during the account servicer's business day.</p>
			<p>CRDT = Credit Balance representing the sum of all credit entries booked to an account.</p>
			<p>CRRT = Current Balance of the account at a precise moment in time.</p>
			<p>DBIT = Debit Balance representing the sum of all debit entries booked to an account.</p>
			<p>DLOD = DaylightOverdraft Balance representing the intra day overdraft granted by the Central Bank to financial institutions participating in a RTGS system. This balance may vary over time and shall be offset at the end of the day.</p>
			<p>EAST = EligibleAssets Balance representing the potential loan a Central Bank would make in cash if the collateral is pledged, eg, securities available and eligible as collateral with the Central Bank.</p>
			<p>INTM = Interim Balance calculated in the course of the account servicer's business day, at the time specified, and subject to further changes during the business day. The interim balance is calculated on the basis of booked credit and debit items during the calculation time/period specified.</p>
			<p>LRLD = LimitRelated Balance of a specific limit value, eg, a bilateral balance is calculated in relation to a given bilateral limit.</p>
			<p>LTSF= LiquidityTransfer Balance composed of the sum of all liquidity transfers made to or from an account.</p>
			<p>OPNG = Opening Book balance of the account at the beginning of the account servicer's business day. It always equals the closing book balance from the previous business day. Note: the available balance at the beginning of the account servicer's business day may be different from the closing book balance from the previous business day.</p>
			<p>PDNG = Pending Balance of securities pending delivery, eg, orders to sell securities have been executed but settlement of the open transactions has not been confirmed.</p>
			<p>PRAV = ProgressiveAverage Average of the daily balances on the account used to fulfil the reserve requirements calculated from the beginning of the maintenance period.</p>
			<p>PYMT = Payment Balance representing the sum of entries as a result of payments processing. Entries relating to fees, interest, or other movements not a result of payments sent or received by the account owner are not included.</p>
			<p>XCRD = ExpectedCredit Balance, composed of booked entries and pending items known at the time of calculation, which projects the end of day credit balance if everything books to the account and no other credit entry is posted.</p>

name of attribute	format	short description	description
			<p>XDBT = ExpectedDebit Balance, composed of booked entries and pending items known at the time of calculation, which projects the end of day debit balance if everything books to the account and no other debit entry is posted.</p> <p>XPCD = Expected Balance, composed of booked entries and pending items known at the time of calculation , which projects the end of day balance if everything is booked on the account and no other entry is posted.</p> <p>*****NOTE = Noted Balance Balance representing the amount that a financial institution has set aside for a specific reason and which is therefore not available</p>
		Mandatory	Validation: [1..1]
xorFnIStsPdgSts		Choice	
		Mandatory	Validation: [1..1]
<Pdg>-</Pdg>		PendingStatus	Specifies the pending status of the selected transaction. Possible value: PSTL for pending transactions
		Mandatory	Validation: [1..1]
<FnI>-</FnI>		FinalStatus	Specifies the (final) status of the selected transaction. Possible values are: "RJTD" (rejected) for rejected transactions; "STLD" (settled) for transactions successfully processed.
		Mandatory	Validation: [1..1]
/xorFnIStsPdgSts		End of choice	
		Mandatory	Validation: [1..1]
</Cd>		End of PaymentStatusCode	
		Mandatory	Validation: [1..1]
<DtTm>		DateTime	A specified date and time.
		Mandatory	Validation: [1..1]
<DtTm>-</DtTm>	ISODateTime	Date Time	Date and Time at which the transaction assumed its status (yyyy-mm-ddThh:mm:ss).
	e	Mandatory	Validation: [1..1]
</DtTm>		End of DateTime	
		Mandatory	Validation: [1..1]
<Rsn>		Reason	
		Optional	Validation: [0..1]
<PrtryRjctn>		ProprietaryStatusJustification	

name of attribute	format	short description	description
		Mandatory	Validation: [1..1]
<PrtryStsRsn>-</PrtryStsRsn> 4x		Proprietary Status Reason Mandatory	Validation: [1..1]
<Rsn>-</Rsn>	256x	Reason Mandatory	Error code. Validation: [1..1]
</PrtryRjctn>		End of ProprietaryStatusJustificatio n Mandatory	Error description. Validation: [1..1]
</Rsn>		End of Reason Optional	Validation: [0..1]
</Sts>		End of PaymentStatus Mandatory	Validation: [1..1]
<InstdAmt>		Instructed Amount Mandatory	Validation: [1..1]
<AmtWthtCcy>-</AmtWthtCcy>	18n	Amount without currency Mandatory	Amount of the transaction . Validation: [1..1]
</InstdAmt>		End Instructed Amount Mandatory	Validation: [1..1]
<PrcgVldtyTm>		ProcessingValidityTime Optional	This sequence is used to specify the date and the time of settlement. It will be present only if settlement already occurred. Validation: [0..1]
<FrDtTm>-</FrDtTm>	DateTime	From Date Time Mandatory	Settlement Date and Time (yyyy-mm-ddThh:mm:ss). Validation: [1..1]
</PrcgVldtyTm>		End Processing Validity Time Optional	Validation: [0..1]
<Txld>-</Txld>	35x	TransactionIdentification Optional	Unique and unambiguous identification of a payment transaction, as assigned by the originator. The payment transaction reference is used for reconciliation or to link tasks relating to the payment transaction. Transaction identifier, i.e. TRN of the SWIFT input message (first 16 characters of <Msgld> of the input message). Validation:

name of attribute	format	short description	description
			[0..1]
</Pmt>		End Payment Mandatory	Validation: [1..1]
</Tx>		End of Transaction Mandatory	Validation: [1..1]
</TxOrErr>		End of TransactionOrErrorChoice Mandatory	Validation: [1..1]
</TxRpt>		End Transaction Report Mandatory	Validation: [1..n]
</BizRpt>		End of BusinessReport Mandatory	Validation: [1..1]
<OprlErr>		Operational Error Mandatory	Validation: [1..1]
<Err>		Error handling Mandatory	Validation: [1..1]
<Prtry>-</Prtry>	4x	Proprietary error code Mandatory	Specification of the error, in free format. Validation: [1..1]
</Err>		End error handling Mandatory	Validation: [1..1]
<Desc>-</Desc>	140x	Description Optional	Error description Validation: [0..1]
</OprlErr>		End of Operational Error Mandatory	End of Operational Error Validation: [1..1]
/xorBizRptOprlErr		End of choice Mandatory	Validation: [1..1]
</RptOrErr>		End of BusinessReportOrErrorChoice Mandatory	Validation: [1..1]
</RtrTx>		End messagename ReturnTransaction	

name of attribute	format	short description	description
		Mandatory	Validation: [1..1]

Error Codes:

ReturnTransaction_CM_1

Scope: A response to a request of information on all transactions entered during the contingency (see example 1 Get Transaction).

MessageName for Return Transaction	<RtrTx>
Message Header	<MsgHdr>
Message Identification	<MsgId>ABCDEFGHIJKLMNQRST123456789012345</MsgId>
Original Business Query	<OrgnlBizQry>
Message Identification	<MsgId>ABCDEFGHIJKLMNQRST123456789012345</MsgId>
End of Original Business Query	</OrgnlBizQry>
End of Message Header	</MsgHdr>
BusinessReportOrErrorChoice	<RptOrErr>
BusinessReport	<BizRpt>
TransactionReport	<TxRpt>
PaymentIdentification	<PmtId>
ProprietaryId	<PrtryId>ABCDEFGHIIBCCITRRXXX ABCDEFGHIIL1234567890ABC</PrtryId>
EndPaymentIdentification	</PmtId>
TransactionOrErrorChoice	<TxOrErr>
Transaction	<Tx>
PaymentTo	<PmtTo>
Member Identification	<Mmbld>
Financial Institution Identification	<FinInstnId>
BICFIIdentifier	<BICFI>BBBIT22XXX</BICFI>
End of Financial Institution Identification	</FinInstnId>
End Member Identification	</Mmbld>
End PaymentTo	</PmtTo>
End PaymentTo	</PmtTo>
Payment From	<PmtFr>
Member Identification	<Mmbld>
Financial Institution Identification	<FinInstnId>
BICFIIdentifier	<BICFI>RRRRITRRXXX</BICFI>
End of Financial Institution Identification	</FinInstnId>
End Member Identification	</Mmbld>
End Payment From	</PmtFr>
Credit or debit indicator	<CdtDbtInd>DBIT</CdtDbtInd>
Payment	<Pmt>
RequestedExecutionDate	<ReqdExctnDt>
Date Time	<DtTm>1967-08-13T09:31:45-05:00</DtTm>
End of RequestedExecutionDate	</ReqdExctnDt>
PaymentStatus	<Sts>
BalanceTypeCode	<Cd>
FinalStatus	<Fnl>STLD</Fnl>
End of PaymentStatusCode	</Cd>
DateTime	<DtTm>
Date Time	<DtTm>1967-08-13T09:33:47-05:00</DtTm>
End of DateTime	</DtTm>
End of PaymentStatus	</Sts>
Instructed Amount	<InstdAmt>
Amount without currency	<AmtWthtCcy>1234.56</AmtWthtCcy>
End Instructed Amount	</InstdAmt>
ProcessingValidityTime	<PrcgVldtyTm>
From Date Time	<FrDtTm>2001-09-11T09:33:47-05:00</FrDtTm>
End Processing Validity Time	</PrcgVldtyTm>

TransactionIdentification	<TxId>ABCDEFGHIL123456</TxId>
End Payment	</Pmt>
End ofTransaction	</Tx>
End of TransactionOrErrorChoice	</TxOrErr>
End Transaction Report	</TxRpt>
TransactionReport	<TxRpt>
PaymentIdentification	<PmtId>
ProprietaryId	<PrtryId>ABCDEFGHIL BBCCITRRXXX ABCDEFGHIL1234567890ABC</PrtryId>
EndPaymentIdentification	</PmtId>
TransactionOrErrorChoice	<TxOrErr>
Transaction	<Tx>
PaymentTo	<PmtTo>
Member Identification	<Mmbld>
Financial Institution Identification	<FinInstnId>
BICFIIdentifier	<BICFI>>BBBBIT22XXX</BICFI>
End of Financial Institution Identification	</FinInstnId>
End Member Identification	</Mmbld>
Payment From	<PmtFr>
Member Identification	<Mmbld>
Financial Institution Identification	<FinInstnId>
BICFIIdentifier	<BICFI>KKKKITRRXXX</BICFI>
End of Financial Institution Identification	</FinInstnId>
End Member Identification	</Mmbld>
End Payment From	</PmtFr>
Credit or debit indicator	<CdtDbtInd>DBIT</CdtDbtInd>
Payment	<Pmt>
RequestedExecutionDate	<ReqdExctnDt>
Date Time	<DtTm>1967-08-13T09:55:42-05:00</DtTm>
End of RequestedExecutionDate	</ReqdExctnDt>
PaymentStatus	<Sts>
BalanceTypeCode	<Cd>
FinalStatus	<Fnl>STLD</Fnl>
End of PaymentStatusCode	</Cd>
DateTime	<DtTm>
Date Time	<DtTm>1967-08-13T09:33:47-05:00</DtTm>
End of DateTime	</DtTm>
End of PaymentStatus	</Sts>
Instructed Amount	<InstdAmt>
Amount without currency	<AmtWthtCcy>1234.56</AmtWthtCcy>
End Instructed Amount	</InstdAmt>
ProcessingValidityTime	<PrgVldtyTm>
From Date Time	<FrDtTm>2001-09-11T09:33:47-05:00</FrDtTm>
End Processing Validity Time	</PrgVldtyTm>
TransactionIdentification	<TxId>ABCDEFGHIL123456</TxId>
End Payment	</Pmt>
End ofTransaction	</Tx>
End of TransactionOrErrorChoice	</TxOrErr>
End Transaction Report	</TxRpt>
End of BusinessReport	</BizRpt>
End of BusinessReportOrErrorChoice	</RptOrErr>
End messagename ReturnTransaction	</RtrTx>

ReturnTransaction_CM_2

Scope: A response to a request of information on a single transaction (see example 2 of Get Transaction).

MessageName for Return Transaction	<RtrTx>
Message Header	<MsgHdr>
Message Identification	<MsgId>AACDEFGHIJKLMNOPQRST123456789012345</MsgId>
Original Business Query	<OrgnlBizQry>
Message Identification	<MsgId>CMCDEFGHIJKLMNOPQRST123456789012345</MsgId>
End of Original Business Query	</OrgnlBizQry>
End of Message Header	</MsgHdr>
BusinessReportOrErrorChoice	<RptOrErr>
BusinessReport	<BizRpt>
TransactionReport	<TxRpt>
PaymentIdentification	<PmtId>
ProprietaryId	<PrtryId>ABCDEFGHIIBCCIT22XXX ABCDEFGHIIL1234567890ABC</PrtryId>
EndPaymentIdentification	</PmtId>
PaymentTo	<PmtTo>
Member Identification	<Mmbld>
Financial Institution Identification	<FinInstnId>
BICFIIdentifier	<BICFI>BBBIT22XXX</BICFI>
End of Financial Institution Identification	</FinInstnId>
End Member Identification	</Mmbld>
End PaymentTo	</PmtTo>
Payment From	<PmtFr>
Member Identification	<Mmbld>
Financial Institution Identification	<FinInstnId>
BICFIIdentifier	<BICFI>RRRRITRRXXX</BICFI>
End of Financial Institution Identification	</FinInstnId>
End Member Identification	</Mmbld>
End Payment From	</PmtFr>
Credit or debit indicator	<CdtDbtInd>DBIT</CdtDbtInd>
Payment	<Pmt>
RequestedExecutionDate	<ReqdExctnDt>
Date Time	<DtTm>1967-08-13T09:33:47-05:00</DtTm>
End of RequestedExecutionDate	</ReqdExctnDt>
PaymentStatus	<Sts>
BalanceTypeCode	<Cd>
FinalStatus	<Fnl>STLD</Fnl>
End of PaymentStatusCode	</Cd>
DateTime	<DtTm>
Date Time	<DtTm>1967-08-13T09:33:47-05:00</DtTm>
End of DateTime	</DtTm>
End of PaymentStatus	</Sts>
Instructed Amount	<InstdAmt>
Amount without currency	<AmtWthtCcy>1234.56</AmtWthtCcy>
End Instructed Amount	</InstdAmt>
ProcessingValidityTime	<PrcgVldtyTm>
From Date Time	<FrDtTm>2001-09-11T09:33:47-05:00</FrDtTm>
End Processing Validity Time	</PrcgVldtyTm>
TransactionIdentification	<TxId>ABCDEFGHIIL123456</TxId>
End Payment	</Pmt>
End ofTransaction	</Tx>

End of TransactionOrErrorChoice					</TxOrErr>
End Transaction Report					</TxRpt>
End of BusinessReport					</BizRpt>
End of BusinessReportOrErrorChoice					</RptOrErr>
End messagename ReturnTransaction					</RtrTx>

ReturnTransaction_CM_3

Scope: A response to a request of information on all transactions entered in a specific time range and related to a specific participant (see example 3 of Get Transaction).

MessageName for Return Transaction	<RtrTx>
Message Header	<MsgHdr>
Message Identification	<MsgId>CMCDEFGHIJKLMNOPQRST123456789012345</MsgId>
Original Business Query	<OrgnlBizQry>
Message Identification	<MsgId> ABCDEFGHIJKLMNOPQRST123456789012345</MsgId>
End of Original Business Query	</OrgnlBizQry>
End of Message Header	</MsgHdr>
BusinessReportOrErrorChoice	<RptOrErr>
BusinessReport	<BizRpt>
TransactionReport	<TxRpt>
PaymentIdentification	<PmtId>
ProprietaryId	<PrtryId>ABCDEFGHIIBCCITRRXXXABCDEFGHIIL1234567890 ABC</PrtryId>
EndPaymentIdentification	</PmtId>
TransactionOrErrorChoice	<TxOrErr>
Transaction	<Tx>
PaymentTo	<PmtTo>
Member Identification	<Mmbld>
Financial Institution Identification	<FinInstnId>
BICFIIdentifier	<BICFI>BBBBIT22XXX</BICFI>
End of Financial Institution Identification	</FinInstnId>
End Member Identification	</Mmbld>
End PaymentTo	</PmtTo>
Payment From	<PmtFr>
Member Identification	<Mmbld>
Financial Institution Identification	<FinInstnId>
BICFIIdentifier	<BICFI>RRRRITRRXXX</BICFI>
End of Financial Institution Identification	</FinInstnId>
End Member Identification	</Mmbld>
End Payment From	</PmtFr>
Credit or debit indicator	<CdtDbtInd>DBIT</CdtDbtInd>
Payment	<Pmt>
RequestedExecutionDate	<ReqdExctnDt>
Date Time	<DtTm>2007-08-13T08:31:00</DtTm>
End of RequestedExecutionDate	</ReqdExctnDt>
PaymentStatus	<Sts>
BalanceTypeCode	<Cd>
FinalStatus	<Fnl>STLD</Fnl>
End of PaymentStatusCode	</Cd>
DateTime	<DtTm>
Date Time	<DtTm>2007-08-13T08:31:00</DtTm>
End of DateTime	</DtTm>
End of PaymentStatus	</Sts>
Instructed Amount	<InstdAmt>
Amount without currency	<AmtWthtCcy>1234.56</AmtWthtCcy>
End Instructed Amount	</InstdAmt>
ProcessingValidityTime	<PrcgVldtyTm>
From Date Time	<FrDtTm>2007-08-13T08:31:00</FrDtTm>
End Processing Validity Time	</PrcgVldtyTm>
TransactionIdentification	<TxId>ABCDEFGHIIL123456</TxId>

End Payment						</Pmt>
End ofTransaction						</Tx>
End of TransactionOrErrorChoice						</TxOrErr>
End Transaction Report						</TxRpt>
End of BusinessReport						</BizRpt>
End of BusinessReportOrErrorChoice						</RptOrErr>
End messagename ReturnTransaction						</RtrTx>

6.11 XML messages related to PHA

6.11. 1 ConfirmTask (for CBs only)

PHA internal usage

ConfirmTask_PHA_internal

Scope: The ConfirmTask message is sent to confirm a task, which has to be treated according to the four eyes principle. Precondition: the status of the task is "toConfirm".

The ConfirmTask message is only for internal usage and exchanged between ICM and PHA. Therefore detailed validations have to be performed by the CB's PHA.

The Confirm Task message is replied by a Receipt message. Non-Repudiation of Emission (NRE) is given.

<camt.998.001.xx>

Structure:

Name Proprietary message	<PrtryMsg>
Message Identification	<MsgId>
Reference	<Ref></Ref>
End Message Identification	</MsgId>
Proprietary Data	<PrtryData>
Proprietary Data type	<Tp>ConfirmTask</Tp>
SSP Proprietary Data	<SspPrtryDt>
TaskIdentificationSearchCriteria	<TskId>
Additional Reference	<RltdRef>
Reference	<Ref></Ref>
End of Additional Reference	</RltdRef>
End of TaskIdentificationSearchCriteria	</TskId>
End of SSP Proprietary Data	</SspPrtryDt>
End of Proprietary Data	</PrtryData>
End proprietary message	</PrtryMsg>

Attributes:

name of attribute	format	short description	description
<PrtryMsg>		Name Proprietary message Mandatory A2A	Validation:
<MsgId>		Message Identification Mandatory	Message business identification Unique and unambiguous identifier for a message, as assigned by the Sender. This unique identifier can be used for cross-referencing purposes in subsequent messages. Validation: [1..1]
<Ref>-</Ref>	35x	Reference Mandatory A2A	Unique and unambiguous reference Validation: [1..1]
</MsgId>		End Message Identification Mandatory	End of Message Identification Validation: [1..1]
<PrtryData>		Proprietary Data Mandatory A2A	Proprietary Data Validation: [1..1]
<Tp>-</Tp>		Proprietary Data type Mandatory A2A	Proprietary Data type here only ConfirmTask is possible Validation: [1..1]
<SspPrtryDt>		SSP Proprietary Data Mandatory A2A	SSP Proprietary Data Validation: [1..1]
<TskId>		TaskIdentificationSearchCriteria Mandatory A2A	TaskIdentificationSearchCriteria Validation: [1..1]
<RltdRef>		Additional Reference Mandatory A2A	Additional Reference Validation: [1..1]
<Ref>-</Ref>	35x	Reference Mandatory A2A	Unique and unambiguous reference task reference (returned in Receipt message of the original task) Validation: [1..1]
</RltdRef>		End of Additional Reference Mandatory A2A	End of RelatedReference Validation: [1..1]
</TskId>		End of TaskIdentificationSearchCriteria	end of TaskIdentificationSearchCriteria

name of attribute	format	short description	description
		teria	
		Mandatory	Validation:
		A2A	[1..1]
</SspPrtryDt>		End of SSP Proprietary Data	End of SSP Proprietary Data
		Mandatory	Validation:
		A2A	[1..1]
</PrtryData>		End of Proprietary Data	End of Proprietary Data
		Mandatory	Validation:
		A2A	[1..1]
</PrtryMsg>		End proprietary message	
		Mandatory	Validation:
		A2A	

Error Codes:

Order	Error code				Error Text / Validation/ Remark
	SSP	Y-copy	V-shape	XML	
1	P97			P127	Error Text: Initiator DN is the same as used in the underlying writing operation Validation: In case of four eyes principle, the initiator DN of the writing request (e.g. LiquidityTransfer) and the DN of the ConfirmTask has to be different. Remark: to be checked by CB's PHA / Receipt

ConfirmTask_PHA_Internal_1

Scope: Sample

Name Proprietary message	<PrtryMsg>
Message Identification	<Msgld>
Reference	<Ref>ABC123</Ref>
End Message Identification	</Msgld>
Proprietary Data	<PrtryData>
Proprietary Data type	<Tp>ConfirmTask</Tp>
SSP Proprietary Data	<SspPrtryDt>
TaskIdentificationSearchCriteria	<Tskld>
Additional Reference	<RltdRef>
Reference	<Ref>ABC456631331</Ref>
End of Additional Reference	</RltdRef>
End of TaskIdentificationSearchCriteria	</Tskld>
End of SSP Proprietary Data	</SspPrtryDt>
End of Proprietary Data	</PrtryData>
End proprietary message	</PrtryMsg>

6.11. 2 GetAccount

Cash Management Standard

GetAccount_PHA

Scope: The GetAccount message is sent to request information about the

- balance on the proprietary home account (if the related CB supports the interface to ICM).
- standing order liquidity transfer (held at PHA).

The GetAccount message can be sent by the application of the

- direct PM participant
- or the CB acting on behalf of her community

The GetAccount message is replied by a ReturnAccount message.

<camt.003.001.xx>

Structure:

Message Type	<GetAcct>
Message Identification	<MsgId>
Identification	<Id></Id>
End Message Identification	</MsgId>
Account Query Definition.	<AcctQryDef>
AccountCriteria	<AcctCrit>
NewCriteria	<NewCrit>
SearchCriteria	<SchCrit>
Account Identification	<AcctId>
AccountIdentificationChoice	<EQ>
Simple Identification Information	<DmstAcct>
Identification	<Id></Id>
End of simple Identification Information	</DmstAcct>
End of AccountIdentificationChoice	</EQ>
End of Account Identification	</AcctId>
End of SearchCriteria	</SchCrit>
End of NewCriteria	</NewCrit>
End of AccountCriteria	</AcctCrit>
End of AccountQueryDefinition	</AcctQryDef>
End of Message Type	</GetAcct>

Attributes:

name of attribute	format	short description	description
<GetAcct>		Message Type	Message name for GetAccount
		Mandatory	Validation:
		A2A	
<MsgId>		Message Identification	Message business identification
			Unique and unambiguous identifier for a message, as assigned by the Sender. This unique identifier can be used for cross-referencing purposes in subsequent messages.
		Mandatory	Validation:
		A2A	[1..1]
<Id></Id>	35x	Identification	Identification
			String of characters that uniquely identifies a message.
		Mandatory	Validation:
		A2A	[1..1]
</MsgId>		End Message Identification	End of Message Identification
		Mandatory	Validation:
		A2A	[1..1]
<AcctQryDef>		Account Query Definition.	
		Optional	Validation:
		A2A	[0..1]
<AcctCrit>		AccountCriteria	Definition of the account query criteria.
		Optional	Validation:
		A2A	[0..1]
<NewCrit>		NewCriteria	Defines the criteria based on which the information is extracted.
		Mandatory	Validation:
		A2A	[1..1]
<SchCrit>		SearchCriteria	Defines the criteria used to search for.
		Optional	Validation:
		A2A	[0..1]
<AcctId>		Account Identification	
		Optional	Validation:
		A2A	[0..1] account identification used on behalf of third parties, when not stated The PHA account of the participant is used
<EQ>		AccountIdentificationChoice	AccountIdentificationChoice
		Mandatory	Validation:
		A2A	[1..1]
<DmstAcct>		Simple Identification Information	Simple Identification Information
			Domestic Account
			Account number used by financial institutions in individual countries to identify an account of a customer, but

name of attribute	format	short description	description
			necessarily the bank and branch of the financial institution in which the account is held.
		Mandatory A2A	Validation: [1..1]
<Id></Id>	34x	Identification	Name or number assigned by an entity to enable recognition of that entity, eg, account identifier.
		Mandatory A2A	account number of the requested account in PHA Validation: [1..1] mandatory when the requestor is a CB
</DmstAcct>		End of simple Identification Information Mandatory A2A	Validation: [1..1]
</EQ>		End of AccountIdentificationChoice	End of search for one or more accounts based on exact identification of the account(s).
		Mandatory A2A	Validation: [1..1]
</AcctId>		End of Account Identification Optional A2A	Validation: [0..1]
</SchCrit>		End of SearchCriteria	End of SearchCriteria
		Optional A2A	Validation: [0..1]
</NewCrit>		End of NewCriteria Mandatory A2A	Validation: [1..1]
</AcctCrit>		End of AccountCriteria	End of AccountCriteria
		Optional A2A	Validation: [0..1]
</AcctQryDef>		End of AccountQueryDefinition Optional A2A	End of AccountQueryDefinition Validation: [0..1]
</GetAcct>		End of Message Type Mandatory A2A	End of GetAccount Validation:

Error Codes:

Order	Error code				Error Text / Validation/ Remark
	SSP	Y-copy	V-shape	XML	
1	X41			1401	Error Text: No permission. RBAC User role(s) are not sufficient. Validation: RBAC role name "APPLICATE", "APPLICSTE" or "APPLICBTE" are required Remark: checked by ICM / ReturnAccount
2	P25			P025	Error Text: Central Bank does not support the Proprietary Home Account interface Validation: Profile central bank: message is allowed for central banks who supports PHA. Remark: checked by ICM / ReturnAccount
3	P25			P025	Error Text: Central Bank does not support the Proprietary Home Account interface Validation: Profile credit institution: message is allowed for credit institutions of which the responsible CB uses PHA Remark: checked by ICM / ReturnAccount
4	P26			P026	Error Text: The Proprietary Home Account is not available Validation: condition: PHA must be available via SWIFTNet so that the request can be received by PHA and a response will be returned in time Remark: checked by ICM / ReturnAccount
5	P55			P055	Error Text: Account does not exist or is invalid Validation: AcctId/Eq/DmstAcct/Id value must indicate a PHA account of the SSP Participant Remark: checked by ICM / ReturnAccount
6	X42			1402	Error Text: No authorisation. User is not allowed acting on behalf of another participant. Validation: Profile credit institution: AcctId/Eq/DmstAcct/Id value must indicate the PHA account of the CI itself Remark: checked by ICM / ReturnAccount
7	X47			1407	Error Text: No authorisation. User is not allowed acting on behalf of another Participant as Central Bank Validation: Profile central bank: AcctId/Eq/DmstAcct/Id value must indicate the CB itself or a PHA account the CB is responsible for Remark: checked by ICM / ReturnAccount
8	P27			P027	Error Text: Generic error generated by PHA Validation: specific and more detailed validations which will be checked by the Proprietary Home Account Application. These explicit validations will be pooled by SSP under the error text "Generic error generated by PHA" Remark: ReturnAccount

GetAccount_PHA_1

Scope: GetAccount Sender and Account Owner of the request are identic.

Message Type	<GetAcct>
Message Identification	<MsgId>
Identification	<Id>ABCDEFGHIJKLMNOPQRSTUVWXYZ123456789</Id>
End Message Identification	</MsgId>
End of Message Type	</GetAcct>

GetAccount_PHA_2

Scope: GetAccount Sender and Account Owner of the request are different, request on behalf of third party

Message Type	<GetAcct>
Message Identification	<MsgId>
Identification	<Id>ABC</Id>
End Message Identification	</MsgId>
Account Query Definition.	<AcctQryDef>
AccountCriteria	<AcctCrit>
NewCriteria	<NewCrit>
SearchCriteria	<SchCrit>
Account Identification	<AcctId>
AccountIdentificationChoice	<EQ>
Simple Identification Information	<DmstAcct>
Identification	<Id>50080000</Id>
End of simple Identification Information	</DmstAcct>
End of AccountIdentificationChoice	</EQ>
End of Account Identification	</AcctId>
End of SearchCriteria	</SchCrit>
End of NewCriteria	</NewCrit>
End of AccountCriteria	</AcctCrit>
End of AccountQueryDefinition	</AcctQryDef>
End of Message Type	</GetAcct>

6.11. 3 GetCreditLine

SSP Proprietary Messages

GetCreditLine_PHA

Scope: The GetCreditLine message is used to receive information on the credit line currently available

- proprietary home account (if the related CB supports the interface to ICM).

The GetCreditLine message can be sent by the application of the direct PM participant or the CB acting on behalf of her banking community.

The GetCreditLine message is replied by a ReturnCreditLine message.

<camt.998.001.xx>

Structure:

Name Proprietary message	<PrtryMsg>
Message Header	<MsgHdr>
Message Identification	<MsgId></MsgId>
End of Message Header	</MsgHdr>
Proprietary Data	<PrtryData>
Proprietary Data type	<Tp>GetCreditLine</Tp>
Proprietary Data	<Data>
SSP Proprietary Data	<SspPrtryDt>
CreditLineQueryDefinition	<CrdtLnQryDef>
CreditLineCriteriaDefinition	<CrdtLnCrit>
NewCriteria	<NewCrit>
SearchCriteria	<SchCrit>
Account Identification	<AcctId>
AccountIdentificationChoice	<EQ>
Simple Identification Information	<DmstAcct>
Identification	<Id></Id>
End of simple Identification Information	</DmstAcct>
End of AccountIdentificationChoice	</EQ>
End of Account Identification	</AcctId>
End of SearchCriteria	</SchCrit>
End of NewCriteria	</NewCrit>
End of CreditLineCriteriaDefinition	</CrdtLnCrit>
End of CreditLineQueryDefinition	</CrdtLnQryDef>
End of SSP Proprietary Data	</SspPrtryDt>
End of Proprietary Data	</Data>
End of Proprietary Data	</PrtryData>
End proprietary message	</PrtryMsg>

Attributes:

name of attribute	format	short description	description
<PrtryMsg>		Name Proprietary message Mandatory A2A	Validation:
<MsgHdr>		Message Header Mandatory A2A	Set of characteristics specific to the message Message Reference Validation: [1..1]
<MsgId>-</MsgId>	35x	Message Identification Mandatory A2A	Message Identification Validation: [1..1]
</MsgHdr>		End of Message Header Mandatory A2A	Validation: [1..1]
<PrtryData>		Proprietary Data Mandatory A2A	Proprietary Data Validation: [1..1]
<Tp>-</Tp>		Proprietary Data type Mandatory A2A	Proprietary Data type here only GetCreditLine is possible Validation: [1..1]
<Data>		Proprietary Data Mandatory	Proprietary data content Validation: [1..1]
<SspPrtryDt>		SSP Proprietary Data Mandatory A2A	Root element for all SSP proprietary data Validation: [1..1]
<CrdtLnQryDef>		CreditLineQueryDefinition Optional A2A	CreditLineQueryDefinition Validation: [0..1]
<CrdtLnCrit>		CreditLineCriteriaDefinition Optional A2A	CreditLineCriteriaDefinition Validation: [0..1]
<NewCrit>		NewCriteria Mandatory A2A	Defines the criteria based on which the information is extracted. Validation: [1..1]
<SchCrit>		SearchCriteria Optional A2A	Defines the criteria used to search for. Validation: [0..1]

name of attribute	format	short description	description
<AcctId>		Account Identification	Account Identification
		Optional	Validation:
		A2A	[0..1]
<EQ>		AccountIdentificationChoice	Search for one or more accounts based on exact identification of the account(s).
		Mandatory	Validation:
		A2A	[1..1] only one account possible
<DmstAcct>		Simple Identification Information	Simple Identification Information
		Mandatory	Validation:
		A2A	[1..1]
<Id>-</Id>	34x	Identification	Name or number assigned by an entity to enable recognition of that entity, eg, account identifier. account number of the requested account in PHA
		Mandatory	Validation:
		A2A	[1..1]
</DmstAcct>		End of simple Identification Information	
		Mandatory	Validation:
		A2A	[1..1]
</EQ>		End of AccountIdentificationChoice	End of search for one or more accounts based on exact identification of the account(s).
		Mandatory	Validation:
		A2A	[1..1]
</AcctId>		End of Account Identification	
		Optional	Validation:
		A2A	[0..1]
</SchCrit>		End of SearchCriteria	
		Optional	Validation:
		A2A	[0..1]
</NewCrit>		End of NewCriteria	End of NewCriteria
		Mandatory	Validation:
		A2A	[1..1]
</CrdtLnCrit>		End of CreditLineCriteriaDefinition	end of CreditLineCriteriaDefinition
		Optional	Validation:
		A2A	[0..1]
</CrdtLnQryDef>		End of CreditLineQueryDefinition	end of CreditLineQueryDefinition
		Optional	Validation:
		A2A	[0..1]
</SspPrtryDt>		End of SSP Proprietary Data	End of Root element for all SSP proprietary data
		Mandatory	Validation:
		A2A	[1..1]

name of attribute	format	short description	description
</Data>		End of Proprietary Data Mandatory	Validation: [1..1]
</PrtryData>		End of Proprietary Data Mandatory A2A	End of Proprietary Data Validation: [1..1]
</PrtryMsg>		End proprietary message Mandatory A2A	Validation:

Error Codes:

Order	Error code				Error Text / Validation/ Remark
	SSP	Y-copy	V-shape	XML	
1	X41			1401	Error Text: No permission. RBAC User role(s) are not sufficient. Validation: RBAC role name "APPLICATE", "APPLICSTE" or "APPLICBTE" are required Remark: checked by ICM / ReturnCreditLine
2	P25			P025	Error Text: Central Bank does not support the Proprietary Home Account interface Validation: Profile central bank: message is allowed for central banks who supports PHA. Remark: checked by ICM / ReturnCreditLine
3	P25			P025	Error Text: Central Bank does not support the Proprietary Home Account interface Validation: Profile credit institution: message is allowed for credit institutions of which the responsible CB uses PHA Remark: checked by ICM / ReturnCreditLine
4	P26			P026	Error Text: The Proprietary Home Account is not available Validation: condition: PHA must be available via SWIFTNet so that the request can be received by PHA and a response will be returned in time Remark: checked by ICM / ReturnCreditLine
5	P55			P055	Error Text: Account does not exist or is invalid Validation: AcctId/EQ/DmstAcct/Id existing and valid account Remark: checked by ICM / ReturnCreditLine
6	X42			1402	Error Text: No authorisation. User is not allowed acting on behalf of another participant. Validation: Profile credit institution: AcctId/eq/DmstAcct/Id value must indicate the PHA account of the CI itself Remark: To be checked checked by ICM / ReturnCreditLine
7	X47			1407	Error Text: No authorisation. User is not allowed acting on behalf of another Participant as Central Bank Validation: Profile central bank: AcctId/eq/DmstAcct/Id value must indicate the CB itself or a PHA account the CB is responsible for Remark: checked by ICM / ReturnCreditLine
8	P27			P027	Error Text: Generic error generated by PHA Validation: specific and more detailed validations which will be checked by the Proprietary Home Account Application. These explicit validations will be pooled by SSP under the error text "Generic error generated by PHA" Remark: ReturnCreditLine or Receipt

GetCreditLine_PHA_1

Scope: GetCreditLine request for Proprietary home account, Sender and account owner are identic.

Name Proprietary message	<PrtryMsg>
Message Header	<MsgHdr>
Message Identification	<MsgId>ABCDEFGHIJKLMNOPQRSTUVWXYZ123456789</MsgId>
End of Message Header	</MsgId>
Proprietary Data	<PrtryData>
Proprietary Data type	<Tp>GetCreditLine</Tp>
Proprietary Data	<Data>
SSP Proprietary Data	<SspPrtryDt/>
End of Proprietary Data	</Data>
End of Proprietary Data	</PrtryData>
End proprietary message	</PrtryMsg>

GetCreditLine_PHA_2

Scope: GetCreditLine request for Proprietary home account, Sender and account owner are different, request on behalf of third party

Name Proprietary message	<PrtryMsg>
Message Header	<MsgHdr>
Message Identification	<MsgId>ABCDEFGHIJKLMNOPQRSTUVWXYZ123456789</MsgId>
End of Message Header	</MsgId>
Proprietary Data	<PrtryData>
Proprietary Data type	<Tp>GetCreditLine</Tp>
Proprietary Data	<Data>
SSP Proprietary Data	<SspPrtryDt>
CreditLineQueryDefinition	<CrdtLnQryDef>
CreditLineCriteriaDefinition	<CrdtLnCrit>
NewCriteria	<NewCrit>
SearchCriteria	<SchCrit>
Account Identification	<AcctId>
AccountIdentificationChoice	<EQ>
Simple Identification Information	<DmstAcct>
Identification	<Id>50070010</Id>
End of simple Identification Information	</DmstAcct>
End of AccountIdentificationChoice	</EQ>
End of Account Identification	</AcctId>
End of SearchCriteria	</SchCrit>
End of NewCriteria	</NewCrit>
End of CreditLineCriteriaDefinition	</CrdtLnCrit>
End of CreditLineQueryDefinition	</CrdtLnQryDef>
End of SSP Proprietary Data	</SspPrtryDt>
End of Proprietary Data	</Data>
End of Proprietary Data	</PrtryData>
End proprietary message	</PrtryMsg>

6.11. 4 LiquidityCreditTransfer

Cash Management Standard

LiquidityCreditTransfer_PHA

Scope: The LiquidityCreditTransfer message is used to transfer funds between
- two accounts belonging to the same participant from

- proprietary home account to RTGS account (if the related CB supports the interface to ICM).

The LiquidityTransfer message can be sent by the application of the
- direct PM participant in case of transfers between two accounts belonging to the same participant.
- or the CB acting on behalf of her banking community

The LiquidityCreditTransfer message is replied by a Receipt message.
Non-Repudiation of Emission (NRE) is supported.

<camt.050.001.xx>

Structure:

Message name for LiquidityCreditTransfer	<LqdyCdtTrf>
Message Header	<MsgHdr>
Message Identification	<MsgId></MsgId>
End of Message Header	</MsgHdr>
LiquidityCreditTransfer1	<LqdyCdtTrf>
CreditorAccount	<CdtrAcct>
Identification	<Id>
GenericAccountIdentification	<Othr>
Identification	<Id></Id>
End of GenericAccountIdentification	</Othr>
End Identification	</Id>
CashAccountType	<Tp>
ExternalCashAccountTypeCode	<Cd></Cd>
End of BalanceTypeCode	</Tp>
EndCreditorAccount	</CdtrAcct>
Transferred Amount	<TrfdAmt>
Amount without currency	<AmtWthtCcy></AmtWthtCcy>
End of Transferred Amount	</TrfdAmt>
DebtorAccount	<DbtrAcct>
Identification	<Id>
GenericAccountIdentification	<Othr>
Identification	<Id></Id>
End of GenericAccountIdentification	</Othr>
End Identification	</Id>
CashAccountType	<Tp>
ExternalCashAccountTypeCode	<Cd></Cd>
End of CashAccountType	</Tp>
EndDebtorAccount	</DbtrAcct>
End of LiquidityCreditTransfer1	</LqdyCdtTrf>
End message name LiquidityCreditTransfer	</LqdyCdtTrf>

Attributes:

name of attribute	format	short description	description
<LqdyCdtTrf>		Message name for LiquidityCreditTransfer Mandatory	Message name for LiquidityCreditTransfer Validation:
<MsgHdr>		Message Header Mandatory	Set of characteristics specific to the message Validation: [1..1] unique and unambiguous identification of the message
<MsgId>-</MsgId>	16x	Message Identification Mandatory	String of characters that uniquely identifies a message Validation: [1..1]
</MsgHdr>		End of Message Header Mandatory	Validation: [1..1]
<LqdyCdtTrf>		LiquidityCreditTransfer1 Mandatory	LiquidityCreditTransfer Validation: [1..1]
<CdtrAcct>		CreditorAccount Mandatory	Validation: [1..1] credited account - account number of the settlement account (RTGS account)
<Id>		Identification Mandatory	Validation: [1..1] account identification
<Othr>		GenericAccountIdentification Mandatory	GenericAccountIdentification Validation: [1..1] account number
<Id>-</Id>	34x	Identification Mandatory	Name or number assigned by an entity to enable recognition of that entity, eg, account identifier. Validation: [1..1]
</Othr>		End of GenericAccountIdentification Mandatory	End of GenericAccountIdentification Validation: [1..1]
</Id>		End Identification Mandatory	Validation: [1..1]
<Tp>		CashAccountType Mandatory	CashAccountType Validation: [1..1]
<Cd>-</Cd>		ExternalCashAccountType Code	ExternalCashAccountTypeCode SSP restricted code list:

name of attribute	format	short description	description
			<p>CACC = Current Account used to post debits and credits when no specific account has been nominated</p> <p>SACC = Settlement Account used to post debit and credit entries, as a result of transactions cleared and settled through a specific clearing and settlement system.</p>
		Mandatory	<p>Validation: [1..1] only SACC = for RTGS account is used</p>
</Tp>		End of BalanceTypeCode	Specifies the nature of the balance
		Mandatory	<p>Validation: [1..1]</p>
</CdtrAcct>		EndCreditorAccount	
		Mandatory	<p>Validation: [1..1]</p>
<TrfdAmt>		Transferred Amount	<p>The amount may be defined with or without the currency. <AmtWthCcy> CurrencyAndAmount <AmtWthtCcy> ImpliedCurrencyAndAmount</p>
		Mandatory	<p>Validation: [1..1]</p>
<AmtWthtCcy>- </AmtWthtCcy>	18n	Amount without currency	<p>Number of monetary units specified in a currency where the unit of currency is implied by the context.</p> <p>totalDigits = 18 fractionDigits = 5</p>
		Mandatory	<p>Validation: [1..1] amount in Euro in PHA only 2 fraction digits are possible value restriction: maximum value 999.999.999.999,99 0,00 value is not allowed</p>
</TrfdAmt>		End of Transferred Amount	
		Mandatory	<p>Validation: [1..1]</p>
		A2A	
<DbtrAcct>		DebtorAccount	
		Optional	<p>Validation: [0..1] debited account - account number of the home account used on behalf of a third parties</p>
<Id>		Identification	
		Mandatory	<p>Validation: [1..1]</p>
<Othr>		GenericAccountIdentification	GenericAccountIdentification
		Mandatory	<p>Validation: [1..1] account number</p>
<Id>-</Id>	34x	Identification	Name or number assigned by an entity to enable recognition of that entity, eg, account identifier.
		Mandatory	<p>Validation: [1..1]</p>

name of attribute	format	short description	description
</Othr>		End of GenericAccountIdentificatio n Mandatory	End of GenericAccountIdentification Validation: [1..1]
</Id>		End Identification Mandatory	Validation: [1..1]
<Tp>		CashAccountType Mandatory	CashAccountType Validation: [1..1]
<Cd>-</Cd>		ExternalCashAccountType Code Mandatory	ExternalCashAccountTypeCode SSP restricted code list: CACC = Current Account used to post debits and credits when no specific account has been nominated SACC = Settlement Account used to post debit and credit entries, as a result of transactions cleared and settled through a specific clearing and settlement system. Validation: [1..1] here only CACC = home account is used
</Tp>		End of CashAccountType Mandatory	End of CashAccountType Validation: [1..1]
</DbtrAcct>		EndDebtorAccount Optional	Validation: [0..1]
</LqdyCdtTrf>		End of LiquidityCreditTransfer1 Mandatory	End of LiquidityCreditTransfer Validation: [1..1]
</LqdyCdtTrf>		End message name LiquidityCreditTransfer Mandatory	End message name LiquidityCreditTransfer Validation:

Error Codes:

Order	Error code				Error Text / Validation/ Remark
	SSP	Y-copy	V-shape	XML	
1	X00			0000	Error Text: O.k. Validation: Confirmation, that a task is stored in the task queue. A related reference for the subsequent processing (e.g. confirmation) of the task is returned. Remark: Receipt (status code)
2	X44			1404	Error Text: If "non repudiation of emission" is mandatory, the NRE indicator flag has to be present Validation: If non-repudiaton processing is mandatory, the tag <SwInt:NRIndicator>TRUE</SwInt:NRIndicator> has to be present. Remark: checked by ICM / Receipt
3	P25			P025	Error Text: Central Bank does not support the Proprietary Home Account interface Validation: Profile central bank: message is allowed for central banks who supports PHA. Remark: checked by ICM / Receipt
3	X41			1401	Error Text: No permission. RBAC User role(s) are not sufficient. Validation: RBAC role name "APPLICATE", "APPLICSTE" or "APPLICBTE" are required Remark: checked by ICM / Receipt
4	P25			P025	Error Text: Central Bank does not support the Proprietary Home Account interface Validation: Profile credit institution: message is allowed for credit institutions of which the responsible CB uses PHA Remark: checked by ICM / Receipt
5	P26			P026	Error Text: The Proprietary Home Account is not available Validation: condition: PHA must be available via SWIFTNet so that the request can be received by PHA and a response will be returned in time Remark: checked by ICM / Receipt
6	P59			P059	Error Text: Either credit account or debited account must be present Validation: CdtAcct/Id/DmstAcct/Id when not present a debtor must be stated Remark: checked by ICM / Receipt <small>Rule: either credit account or debited account must be present</small>
7	X42			1402	Error Text: No authorisation. User is not allowed acting on behalf of another participant. Validation: Profile credit institution: CdtAcct/Id/DmstAcct/Id must indicate the RTGS main account of the CI Remark: checked by ICM / Receipt
8	X47			1407	Error Text: No authorisation. User is not allowed acting on behalf of another Participant as Central Bank Validation: Profile central bank: CdtAcct/Id/DmstAcct/Id must indicate the RTGS main account that belongs to the CB itself or the CB is responsible for Remark: checked by ICM / Receipt
9	P59			P059	Error Text: Either credit account or debited account must be present Validation: DbtAcct/Id/DmstAcct/Id when not present a creditor must be stated. Remark: checked by ICM / Receipt <small>Rule: either credit account or debited account must be present</small>

Order	Error code				Error Text / Validation/ Remark
	SSP	Y-copy	V-shape	XML	
10	X42			1402	Error Text: No authorisation. User is not allowed acting on behalf of another participant. Validation: Profile credit institution: DbtAcct/Id/DmstAcct/Id value must indicate the PHA account of the CI Remark: checked by ICM / Receipt
11	X47			1407	Error Text: No authorisation. User is not allowed acting on behalf of another Participant as Central Bank Validation: Profile central bank: DbtAcct/Id/DmstAcct/Id must indicate a PHA account that belongs to the CB itself or the CB is responsible for Remark: checked by ICM / Receipt
12	862	C2	TM01	2862	Error Text: Request out of cut-off time Validation: Request before cut-off time Remark: TaskQueue To be checked by CB's PHA / TaskQueue
13	894	K4		2894	Error Text: Function is not allowed in the current business day phase Validation: SSP is open Remark: TaskQueue To be checked by CB's PHA / TaskQueue
14	866	C6	AC06	2866	Error Text: Exclusion of participant Validation: Customer is excluded Remark: TaskQueue To be checked by CB's PHA
15	P58			P058	Error Text: Both credited and debited account are mandatory Validation: in case on behalf scenario credited and debited account are mandatory Remark: TaskQueue To be checked by CB's PHA
16	P57			P057	Error Text: Invalid debited account Validation: debited account does exist in PHA and is valid Remark: TaskQueue To be checked by CB's PHA
17	P56			P056	Error Text: Invalid credited account Validation: credited account does exist in PHA and is valid Remark: TaskQueue To be checked by CB's PHA
18	P67	L6		P067	Error Text: Liquidity on the debited account is not sufficient Validation: Liquidity control Remark: TaskQueue To be checked by CB's PHA
19	P68	L7		P068	Error Text: There is a highly urgent payment in the queue Validation: FIFO principle Remark: TaskQueue To be checked by CB's PHA
20	P27			P027	Error Text: Generic error generated by PHA Validation: specific and more detailed validations which will be checked by the Proprietary Home Account Application. These explicit validations will be pooled by SSP under the error text "Generic error generated by PHA" Remark: TaskQueue or Receipt

LiquidityCreditTransfer_PHA_1

Scope: LiquidityTransfer from Proprietary Home account to RTGS account (Sending party and Account Owner are identic)

Message name for LiquidityCreditTransfer	<LqdyCdtTrf>
Message Header	<MsgHdr>
Message Identification	<MsgId>ABCDEFGHIJKLMNOPQRSTUVWXYZ123456789</MsgId>
End of Message Header	</MsgId>
LiquidityCreditTransfer1	<LqdyCdtTrf>
CreditorAccount	<CdtrAcct>
Identification	<Id>
GenericAccountIdentification	<Othr>
Identification	<Id>PM1234567890</Id>
End of GenericAccountIdentification	</Othr>
End Identification	</Id>
CashAccountType	<Tp>
ExternalCashAccountTypeCode	<Cd>SACC</Cd>
End of BalanceTypeCode	</Tp>
EndCreditorAccount	</CdtrAcct>
Transferred Amount	<TrfdAmt>
Amount without currency	<AmtWthtCcy>12345678.90</AmtWthtCcy>
End of Transferred Amount	</TrfdAmt>
End of LiquidityCreditTransfer1	</LqdyCdtTrf>
End message name LiquidityCreditTransfer	</LqdyCdtTrf>

LiquidityCreditTransfer_PHA_2

Scope: LiquidityTransfer from Proprietary Home account to RTGS account (Sending party and Account Owner are different, request on behalf of third party).

Message name for LiquidityCreditTransfer	<LqdyCdtTrf>
Message Header	<MsgHdr>
Message Identification	<MsgId>ABCDEFGHIJKLMNOPQRSTUVWXYZ123456789</MsgId>
End of Message Header	</MsgHdr>
LiquidityCreditTransfer1	<LqdyCdtTrf>
CreditorAccount	<CdtrAcct>
Identification	<Id>
GenericAccountIdentification	<Othr>
Identification	<Id>PM1234567890</Id>
End of GenericAccountIdentification	</Othr>
End Identification	</Id>
CashAccountType	<Tp>
ExternalCashAccountTypeCode	<Cd>SACC</Cd>
End of BalanceTypeCode	</Tp>
EndCreditorAccount	</CdtrAcct>
Transferred Amount	<TrfdAmt>
Amount without currency	<AmtWthtCcy>12345678.90</AmtWthtCcy>
End of Transferred Amount	</TrfdAmt>
DebtorAccount	<DbtrAcct>
Identification	<Id>
GenericAccountIdentification	<Othr>
Identification	<Id>PHA1234567890</Id>
End of GenericAccountIdentification	</Othr>
End Identification	</Id>
CashAccountType	<Tp>
ExternalCashAccountTypeCode	<Cd>CACC</Cd>
End of CashAccountType	</Tp>
EndDebtorAccount	</DbtrAcct>
End of LiquidityCreditTransfer1	</LqdyCdtTrf>
End message name LiquidityCreditTransfer	</LqdyCdtTrf>

6.11. 5 ModifyStandingOrder

Cash Management Standard

ModifyStandingOrder_PHA

- Scope:** The ModifyStandingOrder message is used to
- define a standing order liquidity transfer from
 - the proprietary home account to the RTGS account (if the CB supports the interface to ICM)
 - modify a standing order liquidity transfer from
 - the proprietary home account to the RTGS account (if the CB supports the interface to ICM)

The ModifyStandingOrder message can be sent by the application of a direct PM participant or the CB acting on behalf of her community.

There is only one StandingOrder possible between PHA and RTGS account.

The ModifyStandingOrder message is replied by a Receipt message. Non-Repudiation of Emission (NRE) is supported.

<camt.024.001.xx>

Structure:

Message Type	<ModfyStgOrdr>
Message Header	<MsgHdr>
Message Identification	<MsgId></MsgId>
End of Message Header	</MsgHdr>
Identification of the standing order	<StgOrdrId>
Account Identification	<Acct>
Identification	<Id>
GenericAccountIdentification	<Othr>
Identification	<Id></Id>
End of GenericAccountIdentification	</Othr>
End Identification	</Id>
End of Account	</Acct>
End of Standing order Id	</StgOrdrId>
Standing order details	<NewStgOrdrValSet>
Amount	<Amt>
Amount without currency	<AmtWthtCcy></AmtWthtCcy>
End of Amount	</Amt>
CreditorAccount	<CdtrAcct>
Identification	<Id>
GenericAccountIdentification	<Othr>
Identification	<Id></Id>
End of GenericAccountIdentification	</Othr>
End Identification	</Id>
CashAccountType	<Tp>
ExternalCashAccountTypeCode	<Cd></Cd>
End of CashAccountType	</Tp>
EndCreditorAccount	</CdtrAcct>
End of Standing order details	</NewStgOrdrValSet>
End of Messagename for ModifyStandingOrder	</ModfyStgOrdr>

Attributes:

name of attribute	format	short description	description
<ModfyStgOrdr>		Message Type Mandatory A2A	Validation:
<MsgHdr>		Message Header Mandatory A2A	Set of characteristics specific to the message Validation: [1..1]
<MsgId>-</MsgId>	35x	Message Identification Mandatory A2A	Message Identification Validation: [1..1]
</MsgHdr>		End of Message Header Mandatory A2A	Validation: [1..1]
<StgOrdrId>		Identification of the standing order Mandatory A2A	Validation: [1..1]
<Acct>		Account Identification Mandatory A2A	Validation: [1..1]
<Id>		Identification Mandatory	Identification Unique and unambiguous identification for the account between the account owner and the account servicer. Validation: [1..1]
<Othr>		GenericAccountIdentification Mandatory A2A	GenericAccountIdentification Validation: [1..1]
<Id>-</Id>	34x	Identification Mandatory A2A	Name or number assigned by an entity to enable recognition of that entity, eg, account identifier. account number of the home account Validation: [1..1]
</Othr>		End of GenericAccountIdentification Mandatory A2A	End of GenericAccountIdentification Validation: [1..1]
</Id>		End Identification Mandatory	Validation: [1..1]
</Acct>		End of Account Mandatory A2A	End of Account Validation: [1..1]

name of attribute	format	short description	description
<StgOrdrlId>		End of Standing order Id	End Standing order Id
		Mandatory	Validation:
		A2A	[1..1]
<NewStgOrdrValSet>		Standing order details	Standing order details
		Mandatory	Validation:
		A2A	[1..1]
<Amt>		Amount	Amount in EUR
		Mandatory	Validation:
		A2A	[1..1]
<AmtWthtCcy>- </AmtWthtCcy>	18n	Amount without currency	Number of monetary units specified in a currency where the unit of currency is implied by the context. totalDigits = 18 fractionDigits = 5
		Mandatory	Validation:
		A2A	[1..1] in PHA only 2 fraction digits are possible value restriction: maximum value 999.999.999.999,99
</Amt>		End of Amount	End of Amount
		Mandatory	Validation:
		A2A	[1..1]
<CdtrAcct>		CreditorAccount	
		Mandatory	Validation:
		A2A	[1..1] credited account - account number of the settlement account (RTGS account)
<Id>		Identification	Identification
		Mandatory	Validation:
		A2A	[1..1]
<Othr>		GenericAccountIdentificatio n	GenericAccountIdentification
		Mandatory	Validation:
		A2A	[1..1]
<Id>-</Id>	34x	Identification	Name or number assigned by an entity to enable recognition of that entity, eg, account identifier.
		Mandatory	Validation:
		A2A	[1..1]
</Othr>		End of GenericAccountIdentificatio n	End of GenericAccountIdentification
		Mandatory	Validation:
		A2A	[1..1]
</Id>		End Identification	
		Mandatory	Validation:
		A2A	[1..1]
<Tp>		CashAccountType	CashAccountType

name of attribute	format	short description	description
		Optional	Validation: [0..1]
<Cd>-</Cd>		ExternalCashAccountType Code	ExternalCashAccountTypeCode SSP restricted code list: CACC = Current Account used to post debits and credits when no specific account has been nominated SACC = Settlement Account used to post debit and credit entries, as a result of transactions cleared and settled through a specific clearing and settlement system.
		Mandatory A2A	Validation: [1..1] only SACC is used
</Tp>		End of CashAccountType	End of CashAccountType
		Optional	Validation: [0..1]
</CdtrAcct>		EndCreditorAccount	
		Mandatory A2A	Validation: [1..1]
</NewStgOrdrValSet>		End of Standing order details	End Standing order details
		Mandatory A2A	Validation: [1..1]
</ModifyStgOrdr>		End of Messagename for ModifyStandingOrder	
		Mandatory A2A	Validation:

Error Codes:

Order	Error code				Error Text / Validation/ Remark
	SSP	Y-copy	V-shape	XML	
1	X00			0000	<p>Error Text: O.k.</p> <p>Validation: Confirmation, that a task is stored in the task queue. A related reference for the subsequent processing (e.g. confirmation) of the task is returned.</p> <p>Remark: Receipt (status code)</p>
2	X44			1404	<p>Error Text: If "non repudiation of emission" is mandatory, the NRE indicator flag has to be present</p> <p>Validation: If non-repudiaton processing is mandatory, the tag <SwInt:NRIndicator>TRUE</SwInt:NRIndicator> has to be present.</p> <p>Remark: checked by ICM / Receipt</p>
3	X41			1401	<p>Error Text: No permission. RBAC User role(s) are not sufficient.</p> <p>Validation: RBAC role name "APPLICATE", "APPLICSTE" or "APPLICBTE" are required</p> <p>Remark: checked by ICM / Receipt</p>
4	P25			P025	<p>Error Text: Central Bank does not support the Proprietary Home Account interface</p> <p>Validation: Profile central bank: message is allowed for central banks who supports PHA.</p> <p>Remark: checked by ICM / Receipt</p>
5	P25			P025	<p>Error Text: Central Bank does not support the Proprietary Home Account interface</p> <p>Validation: Profile credit institution: message is allowed for credit institutions of which the responsible CB uses PHA</p> <p>Remark: checked by ICM / Receipt</p>
6	P26			P026	<p>Error Text: The Proprietary Home Account is not available</p> <p>Validation: condition: PHA must be available via SWIFTNet so that the request can be received by PHA and a response will be returned in time</p> <p>Remark: checked by ICM / Receipt</p>
7	X42			1402	<p>Error Text: No authorisation. User is not allowed acting on behalf of another participant.</p> <p>Validation: Profile credit institution: AcctId/DmstAcct/Id value must indicate the PHA account of the CI itself</p> <p>Remark: checked by ICM / Receipt</p>
8	X47			1407	<p>Error Text: No authorisation. User is not allowed acting on behalf of another Participant as Central Bank</p> <p>Validation: Profile central bank: AcctId/DmstAcct/Id value must indicate a PHA that belongs to the CB or a participant the CB is responsible for</p> <p>Remark: checked by ICM / Receipt</p>
9	X42			1402	<p>Error Text: No authorisation. User is not allowed acting on behalf of another participant.</p> <p>Validation: Profile credit institution: CdtAcct/Id/DmstAcct/Id must indicate the RTGS main account of the CI</p> <p>Remark: checked by ICM / Receipt</p>
10	X47			1407	<p>Error Text: No authorisation. User is not allowed acting on behalf of another Participant as Central Bank</p> <p>Validation: Profile central bank: CdtAcct/Id/DmstAcct/Id must indicate the RTGS main account that belongs to the CB itself or the CB is responsible for</p> <p>Remark: checked by ICM / Receipt</p>

Order	Error code				Error Text / Validation/ Remark
	SSP	Y-copy	V-shape	XML	
11	P55			P055	Error Text: Account does not exist or is invalid Validation: CdtAcct/Id/DmstAcct/Id credited account does exist in PHA and is valid Remark: TaskQueue To be checked by CB's PHA
12	P55			P055	Error Text: Account does not exist or is invalid Validation: AcctId/DmstAcct/Id debited account does exist in PHA and is valid Remark: TaskQueue To be checked by CB's PHA
13	P27			P027	Error Text: Generic error generated by PHA Validation: specific and more detailed validations which will be checked by the Proprietary Home Account Application. These explicit validations will be pooled by SSP under the error text "Generic error generated by PHA" Remark: TaskQueue or Receipt

ModifyStandingOrder_PHA_1

Scope: Define Standing Order from Proprietary Home Account to RTGS account.

Message Type	<ModfyStgOrdr>
Message Header	<MsgHdr>
Message Identification	<MsgId>ABCDEFGHIJKLMNOPQRSTUVWXYZ123456789</MsgId>
End of Message Header	</MsgHdr>
Identification of the standing order	<StgOrdrId>
Account Identification	<Acct>
Identification	<Id>
GenericAccountIdentification	<Othr>
Identification	<Id>PHA1234567890</Id>
End of GenericAccountIdentification	</Othr>
End Identification	</Id>
End of Account	</Acct>
End of Standing order Id	</StgOrdrId>
Standing order details	<NewStgOrdrValSet>
Amount	<Amt>
Amount without currency	<AmtWthtCcy>12345678.90</AmtWthtCcy>
End of Amount	</Amt>
CreditorAccount	<CdtrAcct>
Identification	<Id>
GenericAccountIdentification	<Othr>
Identification	<Id>PM1234567890</Id>
End of GenericAccountIdentification	</Othr>
End Identification	</Id>
CashAccountType	<Tp>
ExternalCashAccountTypeCode	<Cd>SACC</Cd>
End of CashAccountType	</Tp>
EndCreditorAccount	</CdtrAcct>
End of Standing order details	</NewStgOrdrValSet>
End of Messagename for ModifyStandingOrder	</ModfyStgOrdr>

6.11. 6 ReturnAccount

Cash Management Standard

ReturnAccount_PHA

Scope: The ReturnAccount message is used to return information about the

- balance on the proprietary home account (if the related CB supports the interface to ICM).
- standing order liquidity transfer (held at PHA).

The connected request is performed by a GetAccount message.

<camt.004.001.xx>

Structure:

Message Type	<RtrAcct>
Message Header	<MsgHdr>
Message Identification	<MsgId></MsgId>
Original Business Query	<OrgnlBizQry>
Message Identification	<MsgId></MsgId>
End of Original Business Query	</OrgnlBizQry>
End of Message Header	</MsgHdr>
AccountOrOperationalErrorChoice	<RptOrErr>
Choice	xorAcctRptOprlErr
AccountReport	<AcctRpt>
Account Identification	<AcctId>
GenericAccountIdentification	<Othr>
Identification	<Id></Id>
End of GenericAccountIdentification	</Othr>
End of Account Identification	</AcctId>
Account information (or business error)	<AcctOrErr>
Account Identification	<Acct>
MultilateralBalance	<MulBal>
Amount	<Amt></Amt>
Credit or debit indicator	<CdtDbtInd></CdtDbtInd>
Balance Type choice	<Tp>
BalanceTypeCode	<Cd></Cd>
End balance type choice	</Tp>
End of MultilateralBalance	</MulBal>
StandingOrder	<StgOrdr>
Amount	<Amt>
Amount without currency	<AmtWthtCcy></AmtWthtCcy>
End of Amount	</Amt>
Credit or debit indicator	<CdtDbtInd></CdtDbtInd>
Associated Pool Account	<AssoctdPoolAcct>
GenericAccountIdentification	<Othr>
Identification	<Id></Id>
End of GenericAccountIdentification	</Othr>
End Associated Pool Account	</AssoctdPoolAcct>
End of Standing Order	</StgOrdr>
End of Account	</Acct>
End of Account or Business Error	</AcctOrErr>
End of AccountReport	</AcctRpt>
OperationalError	<OprlErr>
Error handling	<Err>

Proprietary error code				<Prtry></Prtry>
End error handling				</Err>
Description				<Desc></Desc>
End of Operational Error				</OprlErr>
End of Choice				/xorAcctRptOprlErr
End of AccountOrOperationalErrorChoice				</RptOrErr>
End of Message Type				</RtrAcct>

Attributes:

name of attribute	format	short description	description
<RtrAcct>		Message Type Mandatory A2A	Validation:
<MsgHdr>		Message Header Mandatory A2A	Set of characteristics specific to the message Validation: [1..1]
<MsgId>-</MsgId>	35x	Message Identification Mandatory A2A	Message Identification Validation: [1..1]
<OrgnlBizQry>		Original Business Query Optional A2A	Original Business Query, reference to the query Validation: [0..1]
<MsgId>-</MsgId>	35x	Message Identification Mandatory	Message Identification Used in a SSP timeout message Validation: [1..1]
</OrgnlBizQry>		End of Original Business Query Mandatory	End of Original Business Query, reference to the query Reference to the pending data Validation: [0..1]
</MsgHdr>		End of Message Header Mandatory	Validation: [1..1]
<RptOrErr>		AccountOrOperationalError Choice Mandatory A2A	Validation:
xorAcctRptOprlErr		Choice Mandatory A2A	Choice between AccountReport and OperationalError Validation: [1..1]
<AcctRpt>		AccountReport Mandatory A2A	Validation: [1..n]
<AcctId>		Account Identification Mandatory A2A	Validation: [1..1]
<Othr>		GenericAccountIdentificatio n Mandatory A2A	GenericAccountIdentification Validation: [1..1]
<Id>-</Id>	34x	Identification	Name or number assigned by an entity to enable recognition of that entity, eg, account identifier. Account number of the requested Proprietary home account

name of attribute	format	short description	description
		Mandatory A2A	Validation: [1..1]
</Othr>		End of GenericAccountIdentification Mandatory A2A	End of GenericAccountIdentification Validation: [1..1]
</AcctId>		End of Account Identification Mandatory A2A	Validation: [1..1]
<AcctOrErr>		Account information (or business error) Mandatory	Validation: [1..1]
<Acct>		Account Identification Mandatory A2A	Validation: [1..1] BusinessError is not used
<MulBal>		MultilateralBalance Mandatory A2A	Validation: [2..2]
<Amt>-</Amt>	18d	Amount Mandatory A2A	Validation: [1..1] in PHA only 2 fraction digits are possible
<CdtDbtInd>-</CdtDbtInd>	4!a	Credit or debit indicator Mandatory A2A	Validation: [1..1]
<Tp>		Balance Type choice Mandatory	Validation: [1..1]
<Cd>		BalanceTypeCode	Specifies the nature of the balance, eg, opening balance. ADJT= Adjustment Average balance to be held in the settlement account at the end of each day in order to fulfil the reserve due. The approximation will be always made rounding up. AVLB = Available Balance of money or securities that is at the disposal of the account owner on the date specified. BLCK = Blocked Balance representing the regulatory reserve that a financial institution must have with the account servicing institution, eg, the minimum credit balance a financial institution is to keep with ist Central Bank for mandatory reserve purposes. In some countries, a blocked balance is known as a 'reserve' balance. BOOK = Book Balance that is registered in the books of the account servicer. CLSG = Closing Balance of the account at the end of the account servicer's business day. It is the sum of the opening balance at the beginning of the day and all entries booked to the account during the account servicer's

name of attribute	format	short description	description
			business day.
			<p>CRDT = Credit Balance representing the sum of all credit entries booked to an account.</p> <p>CRRT = Current Balance of the account at a precise moment in time.</p> <p>DBIT = Debit Balance representing the sum of all debit entries booked to an account.</p> <p>DLOD = DaylightOverdraft Balance representing the intra day overdraft granted by the Central Bank to financial institutions participating in a RTGS system. This balance may vary over time and shall be offset at the end of the day.</p> <p>EAST = EligibleAssets Balance representing the potential loan a Central Bank would make in cash if the collateral is pledged, eg, securities available and eligible as collateral with the Central Bank.</p> <p>INTM = Interim Balance calculated in the course of the account servicer's business day, at the time specified, and subject to further changes during the business day. The interim balance is calculated on the basis of booked credit and debit items during the calculation time/period specified.</p> <p>LRLD = LimitRelated Balance of a specific limit value, eg, a bilateral balance is calculated in relation to a given bilateral limit.</p> <p>LTSF= LiquidityTransfer Balance composed of the sum of all liquidity transfers made to or from an account.</p> <p>OPNG = Opening Book balance of the account at the beginning of the account servicer's business day. It always equals the closing book balance from the previous business day. Note: the available balance at the beginning of the account servicer's business day may be different from the closing book balance from the previous business day.</p> <p>PDNG = Pending Balance of securities pending delivery, eg, orders to sell securities have been executed but settlement of the open transactions has not been confirmed.</p> <p>PRAV = ProgressiveAverage Average of the daily balances on the account used to fulfil the reserve requirements calculated from the beginning of the maintenance period.</p> <p>PYMT = Payment Balance representing the sum of entries as a result of payments processing. Entries relating to fees, interest, or other movements not a result of payments sent or received by the account owner are not included.</p> <p>XCRD = ExpectedCredit Balance, composed of booked entries and pending items known at the time of calculation, which projects the end of day credit balance if everything books to the account and no other credit entry is posted.</p> <p>XDBT = ExpectedDebit Balance, composed of booked entries and pending items known at the time of calculation, which projects the end of day debit balance if everything books to the account and no other debit entry is posted.</p> <p>XPCD = Expected Balance, composed of booked entries and pending items known at the time of calculation , which projects</p>

name of attribute	format	short description	description
			<p>the end of day balance if everything is booked on the account and no other entry is posted.</p> <p>*****NOTE = Noted Balance Balance representing the amount that a financial institution has set aside for a specific reason and which is therefore not available</p> <p>Mandatory</p> <p>Validation: [1..1]BLCK (= blocked amountf and not available balances) and CRRT (=current account balance) are used.</p>
</Tp>		End balance type choice	<p>Mandatory</p> <p>Validation: [1..1]</p>
</MulBal>		End of MultilateralBalance	<p>Mandatory</p> <p>A2A</p> <p>Validation: [2..2]</p>
<StgOrdr>		StandingOrder	<p>Optional</p> <p>A2A</p> <p>Validation: [0..1]</p>
<Amt>		Amount	<p>Mandatory</p> <p>A2A</p> <p>Validation: [1..1]</p>
<AmtWthtCcy>-</AmtWthtCcy>	18n	Amount without currency	<p>Number of monetary units specified in a currency where the unit of currency is implied by the context.</p> <p>The integer part of Amount must contain at least one digit. The decimal separator is a dot '.'. It is not mandatory but included in the maximum length. The number of digits following the dot must not exceed the maximum number allowed for that specific currency as specified in ISO 4217.</p> <p>Mandatory</p> <p>A2A</p> <p>Validation: [1..1]</p>
</Amt>		End of Amount	<p>Mandatory</p> <p>A2A</p> <p>Validation: [1..1]</p>
<CdtDbtInd>-</CdtDbtInd>	4!a	Credit or debit indicator	<p>Mandatory</p> <p>A2A</p> <p>Validation: [1..1] only CRDT is possible</p>
<AssocdPoolAcct>		Associated Pool Account	<p>Associated Pool Account</p> <p>The Liquidity transfer origin or destination account within the pool of accounts under management of the requestor credited account</p> <p>Mandatory</p> <p>A2A</p> <p>Validation: [1..1]</p>
<Othr>		GenericAccountIdentification	<p>GenericAccountIdentification</p> <p>Mandatory</p> <p>A2A</p> <p>Validation: [1..1]</p>

name of attribute	format	short description	description
<Id></Id>	34x	Identification	Name or number assigned by an entity to enable recognition of that entity, eg, account identifier. account number of the credited account (RTGS account) Mandatory A2A Validation: [1..1]
</Othr>		End of GenericAccountIdentification	End of GenericAccountIdentification Mandatory A2A Validation: [1..1]
</AssoctdPoolAcct>		End Associated Pool Account	End Associated Pool Account Mandatory A2A Validation: [1..1]
</StgOrd>		End of Standing Order	Optional A2A Validation: [0..1]
</Acct>		End of Account	Mandatory A2A Validation: [1..1]
</AcctOrErr>		End of Account or Business Error	Mandatory Validation: [1..1]
</AcctRpt>		End of AccountReport	Mandatory A2A Validation: [1..n]
<OpriErr>		OperationalError	Rule rationale: The message will contain either the information matching the search criteria of the related Get message or an error indication. Rule description: If BusinessReport is present then OperationalError is not allowed. If BusinessReport is not present, then OperationalError is mandatory. Separate Specification see UDFS books regarding error codes Mandatory A2A Validation: [1..1]
<Err>		Error handling	Mandatory Validation: [1..1]
<Prtry></Prtry>	4x	Proprietary error code	Specification of the error, in free format. Mandatory Validation: [1..1]
</Err>		End error handling	Mandatory Validation: [1..1]
<Desc></Desc>	140x	Description	Specification of the error, in free format.

name of attribute	format	short description	description
		Optional A2A	Validation: [0..1]
</OpriErr>		End of Operational Error Mandatory A2A	End of Operational Error Validation: [1..1]
/xorAcctRptOpriErr		End of Choice Mandatory A2A	Validation:
</RptOrErr>		End of AccountOrOperationalError Choice Mandatory	Validation: [1..1]
</RtrAcct>		End of Message Type Mandatory A2A	Validation:

Error Codes:

ReturnAccount_PHA_1

Scope: ReturnAccount: return information about the balance on the proprietary home account (current and blocked) and standing order liquidity transfer.

Message Type	<RtrAcct>
Message Header	<MsgHdr>
Message Identification	<MsgId> ABCDEFGHIJKLMNOPQRST1234567895</MsgId>
End of Message Header	</MsgHdr>
AccountOrOperationalErrorChoice	<RptOrErr>
AccountReport	<AcctRpt>
Account Identification	<AcctId>
GenericAccountIdentification	<Othr>
Identification	<Id>PHA1234567890</Id>
End of GenericAccountIdentification	</Othr>
End of Account Identification	</AcctId>
Account information (or business error)	<AcctOrErr>
Account Identification	<Acct>
MultilateralBalance	<MulBal>
Amount	<Amt>30000000.00</Amt>
Credit or debit indicator	<CdtDbtInd>CRDT</CdtDbtInd>
Balance Type choice	<Tp>
BalanceTypeCode	<Cd>BLCK</Cd>
End balance type choice	</Tp>
End of MultilateralBalance	</MulBal>
MultilateralBalance	<MulBal>
Amount	<Amt>200000.00 </Amt>
Credit or debit indicator	<CdtDbtInd>CRDT</CdtDbtInd>
Balance Type choice	<Tp>
BalanceTypeCode	<Cd>CRRT</Cd>
End balance type choice	</Tp>
End of MultilateralBalance	</MulBal>
StandingOrder	<StgOrdr>
Amount	<Amt>
Amount without currency	<AmtWthtCcy>100000.00</AmtWthtCcy>
End of Amount	</Amt>
Credit or debit indicator	<CdtDbtInd>CRDT</CdtDbtInd>
Associated Pool Account	<AssoctdPoolAcct>
GenericAccountIdentification	<Othr>
Identification	<Id>PM1234567890</Id>
End of GenericAccountIdentification	</Othr>
End Associated Pool Account	</AssoctdPoolAcct>
End of Standing Order	</StgOrdr>
End of Account	</Acct>
End of Account or Business Error	</AcctOrErr>
End of AccountReport	</AcctRpt>
End of AccountOrOperationalErrorChoice	</RptOrErr>
End of Message Type	</RtrAcct>

6.11. 7 ReturnCreditLine

SSP Proprietary Messages

ReturnCreditLine_PHA

Scope: The ReturnCreditLine message is used to return information on the credit line currently available on the

- proprietary home account (if the related CB supports the interface to ICM).

The connected request is performed by a GetCreditLine message.

<camt.998.001.xx>

Structure:

Name Proprietary message	<PrtryMsg>
Message Header	<MsgHdr>
Message Identification	<MsgId></MsgId>
End of Message Header	</MsgHdr>
Related	<Rltd>
Reference	<Ref></Ref>
End of Related	</Rltd>
Proprietary Data	<PrtryData>
Proprietary Data type	<Tp>ReturnCreditLine</Tp>
Proprietary Data	<Data>
SSP Proprietary Data	<SspPrtryDt>
choice	xorBizRptOprlErr
BusinessReport	<BizRpt>
Credit Line Report	<CrdtLnRpt>
CreditLineIdentification	<CrdtId>
Account Identification	<AcctId>
Simple Identification Information	<DmstAcct>
Identification	<Id></Id>
End of simple Identification Information	</DmstAcct>
End of Account Identification	</AcctId>
End Credit Line Identification	</CrdtId>
Credit Details	<CrdtDtls>
Amount without currency	<AmtWthtCcy></AmtWthtCcy>
End Credit Details	</CrdtDtls>
End of Credit Line Report	</CrdtLnRpt>
End of BusinessReport	</BizRpt>
OperationalError	<OprlErr>
Error handling	<Err>
Proprietary error code	<Prtry></Prtry>
End error handling	</Err>
Description	<Desc></Desc>
End of Operational Error	</OprlErr>
End choice	/xorBizRptOprlErr
End of SSP Proprietary Data	</SspPrtryDt>
End of Proprietary Data	</Data>
End of Proprietary Data	</PrtryData>
End proprietary message	</PrtryMsg>

Attributes:

name of attribute	format	short description	description
<PrtryMsg>		Name Proprietary message Mandatory A2A	Validation:
<MsgHdr>		Message Header Mandatory A2A	Set of characteristics specific to the message Validation: [1..1]
<MsgId>-</MsgId>	35x	Message Identification Mandatory A2A	Message Identification Validation: [1..1]
</MsgHdr>		End of Message Header Mandatory A2A	Validation: [1..1]
<Rltd>		Related Mandatory A2A	References a previously received message. Validation: [1..1]
<Ref>-</Ref>	35x	Reference Mandatory A2A	Unique and unambiguous reference Validation: [1..1]
</Rltd>		End of Related Mandatory A2A	End of Related Validation: [1..1]
<PrtryData>		Proprietary Data Mandatory A2A	Proprietary Data Validation: [1..1]
<Tp>-</Tp>		Proprietary Data type Mandatory A2A	Proprietary Data type Validation: [1..1]
<Data>		Proprietary Data Mandatory	Proprietary data content Validation: [1..1]
<SspPrtryDt>		SSP Proprietary Data Mandatory A2A	Root element for all SSP proprietary data Validation: [1..1]
xorBizRptOprlErr		choice Mandatory A2A	choice amongst BizRpt und OprlErr Rule description: If BusinessReport is present then OperationalError is not allowed. If BusinessReport is not present, then OperationalError is mandatory. Validation:

name of attribute	format	short description	description
<BizRpt>		BusinessReport	BusinessReport
		Mandatory	Validation: [1..1]
		A2A	
<CrdtLnRpt>		Credit Line Report	CreditLineReport
		Mandatory	Validation: [1..1]
		A2A	
<CrdtId>		CreditLineIdentification	CreditLineIdentification free format tag
		Mandatory	Validation: [1..1]
		A2A	
<AcctId>		Account Identification	Account Identification
		Mandatory	Validation: [1..1]
		A2A	
<DmstAcct>		Simple Identification Information	Simple Identification Information
		Mandatory	Validation: [1..1]
		A2A	
<Id>-</Id>	34x	Identification	Name or number assigned by an entity to enable recognition of that entity, eg, account identifier. account number of the proprietary home account
		Mandatory	Validation: [1..1]
		A2A	
</DmstAcct>		End of simple Identification Information	
		Mandatory	Validation: [1..1]
		A2A	
</AcctId>		End of Account Identification	
		Mandatory	Validation: [1..1]
		A2A	
</CrdtId>		End Credit Line Identification	End Credit Line Identification free format tag
		Mandatory	Validation: [1..1]
		A2A	
<CrdtDtls>		Credit Details	Credit Details free format tag
		Mandatory	Validation: [1..1]
		A2A	
<AmtWthtCcy>-</AmtWthtCcy>	18n	Amount without currency	
		Mandatory	Validation: [1..1] in PHA only 2 fraction digits are possible
		A2A	
</CrdtDtls>		End Credit Details	End Credit Details

name of attribute	format	short description	description
		Mandatory A2A	Validation: [1..1]
</CrdtLnRpt>		End of Credit Line Report Mandatory A2A	End of CreditLineReport Validation: [1..1]
</BizRpt>		End of BusinessReport Mandatory A2A	Validation: [1..1]
<OprlErr>		OperationalError Mandatory A2A	Indicates an operational error Rule description: If BusinessReport is present then OperationalError is not allowed. If BusinessReport is not present, then OperationalError is mandatory. Validation: [1..1]
<Err>		Error handling Mandatory	Validation: [1..1]
<Prtry>-</Prtry>	4x	Proprietary error code Mandatory	Specification of the error, in free format. Validation: [1..1]
</Err>		End error handling Mandatory	Validation: [1..1]
<Desc>-</Desc>	140x	Description Optional A2A	Specification of the error, in free format. Validation: [0..1]
</OprlErr>		End of Operational Error Mandatory A2A	End of Operational Error Validation: [1..1]
/xorBizRptOprlErr		End choice Mandatory A2A	Rule description: If BusinessReport is present then OperationalError is not allowed. If BusinessReport is not present, then OperationalError is mandatory. Validation:
</SspPrtryDt>		End of SSP Proprietary Data Mandatory A2A	End of Root element for all SSP proprietary data Validation: [1..1]
</Data>		End of Proprietary Data Mandatory	Validation: [1..1]
</PrtryData>		End of Proprietary Data Mandatory	End of Proprietary Data Validation:

name of attribute	format	short description	description
		A2A	[1..1]
</PrtryMsg>		End proprietary message Mandatory A2A	Validation:

Error Codes:

ReturnCreditLine_PHA_1

Scope: Sample: ReturnCreditLine

Name Proprietary message	<PrtryMsg>
Message Header	<MsgHdr>
Message Identification	<MsgId>ABCDEFGHIJKLMNOPQRSTUVWXYZ123456789</MsgId>
End of Message Header	</MsgId>
Related	<Rltd>
Reference	<Ref>ABCDEFGHIJKLMNOPQRSTUVWXYZ123456789</Ref>
End of Related	</Rltd>
Proprietary Data	<PrtryData>
Proprietary Data type	<Tp>ReturnCreditLine</Tp>
Proprietary Data	<Data>
SSP Proprietary Data	<SspPrtryDt>
BusinessReport	<BizRpt>
Credit Line Report	<CrdtLnRpt>
CreditLineIdentification	<CrdtId>
Account Identification	<AcctId>
Simple Identification Information	<DmstAcct>
Identification	<Id>PHA1234567890</Id>
End of simple Identification Information	</DmstAcct>
End of Account Identification	</AcctId>
End Credit Line Identification	</CrdtId>
Credit Details	<CrdtDtls>
Amount without currency	<AmtWthtCcy>50000.00</AmtWthtCcy>
End Credit Details	</CrdtDtls>
End of Credit Line Report	</CrdtLnRpt>
End of BusinessReport	</BizRpt>
End of SSP Proprietary Data	</SspPrtryDt>
End of Proprietary Data	</Data>
End of Proprietary Data	</PrtryData>
End proprietary message	</PrtryMsg>

6.11. 8 RevokeTask (for CBs only)

PHA internal usage

RevokeTask_PHA_Internal

Scope: The RevokeTask message is sent to revoke a task, where the status of the task is "to confirm".

The ConfirmTask message is only for internal usage and exchanged between ICM and PHA. Therefore detailed validations have to be performed by the CB's PHA.

The RevokeTask message is replied by a Receipt message.
Non-Repudiation of Emission (NRE) is given.

<camt.998.001.xx>

Structure:

Name Proprietary message	<PrtryMsg>
Message Identification	<MsgId>
Reference	<Ref></Ref>
End Message Identification	</MsgId>
Proprietary Data	<PrtryData>
Proprietary Data type	<Tp>RevokeTask</Tp>
SSP Proprietary Data	<SspPrtryDt>
TaskIdentificationSearchCriteria	<TskId>
Additional Reference	<RltdRef>
Reference	<Ref></Ref>
End of Additional Reference	</RltdRef>
End of TaskIdentificationSearchCriteria	</TskId>
End of SSP Proprietary Data	</SspPrtryDt>
End of Proprietary Data	</PrtryData>
End proprietary message	</PrtryMsg>

Attributes:

name of attribute	format	short description	description
<PrtryMsg>		Name Proprietary message Mandatory A2A	Validation:
<MsgId>		Message Identification Mandatory A2A	Message business identification Unique and unambiguous identifier for a message, as assigned by the Sender. This unique identifier can be used for cross-referencing purposes in subsequent messages. Message Reference Validation: [1..1]
<Ref>-</Ref>	35x	Reference Mandatory A2A	Unique and unambiguous reference Validation: [1..1]
</MsgId>		End Message Identification Mandatory A2A	Validation: [1..1]
<PrtryData>		Proprietary Data Mandatory A2A	Proprietary Data Validation: [1..1]
<Tp>-</Tp>		Proprietary Data type Mandatory A2A	Proprietary Data type here only RevokeTask is possible Validation: [1..1]
<SspPrtryDt>		SSP Proprietary Data Mandatory A2A	SSP Proprietary Data Validation: [1..1]
<TskId>		TaskIdentificationSearchCriteria Mandatory A2A	TaskIdentificationSearchCriteria Validation: [1..1]
<RltdRef>		Additional Reference Mandatory A2A	Additional Reference Validation: [1..1]
<Ref>-</Ref>	35x	Reference Mandatory A2A	Unique and unambiguous reference task reference (returned in Receipt message of the original task) Validation: [1..1]
</RltdRef>		End of Additional Reference Mandatory A2A	End of RelatedReference Validation: [1..1]
</TskId>		End of TaskIdentificationSearchCriteria	end of TaskIdentificationSearchCriteria

name of attribute	format	short description	description
		teria	
		Mandatory	Validation:
		A2A	[1..1]
</SspPrtryDt>		End of SSP Proprietary Data	End of SSP Proprietary Data
		Mandatory	Validation:
		A2A	[1..1]
</PrtryData>		End of Proprietary Data	End of Proprietary Data
		Mandatory	Validation:
		A2A	[1..1]
</PrtryMsg>		End proprietary message	
		Mandatory	Validation:
		A2A	

Error Codes:

Order	Error code				Error Text / Validation/ Remark
	SSP	Y-copy	V-shape	XML	
1	P97			P127	Error Text: Initiator DN is the same as used in the underlying writing operation Validation: In case of four eyes principle, the initiator DN of the writing request (e.g. LiquidityTransfer) and the DN of the RevokeTask has to be different. Remark: to be checked by CB's PHA / Receipt

RevokeTask_PHA_Internal_1

Scope: Sample

Name Proprietary message	<PrtryMsg>
Message Identification	<MsgId>
Reference	<Ref>ABC456</Ref>
End Message Identification	</MsgHdr>
Proprietary Data	<PrtryData>
Proprietary Data type	<Tp>RevokeTask</Tp>
SSP Proprietary Data	<SspPrtryDt>
TaskIdentificationSearchCriteria	<TskId>
Additional Reference	<RltdRef>
Reference	<Ref>MN78</Ref>
End of Additional Reference	</RltdRef>
End of TaskIdentificationSearchCriteria	</TskId>
End of SSP Proprietary Data	</SspPrtryDt>
End of Proprietary Data	</PrtryData>
End proprietary message	</PrtryMsg>

6.12 XML messages related to T2SI

6.12. 1 BankToCustomerDebitCreditNotification

Cash Management Standard

BankToCustomerDebitCreditNotification_T2SI

M

Scope: The BankToCustomerDebitCreditNotification message is pushed to the account holder in case of liquidity transfers to T2S if not initiated by the account holder himself via XML or MT message. In other words, if he is not notified about liquidity transfer with T2S via a payment message (LiquidityCreditTransfer, LiquidityDebitTransfer or MT202).

The XML message informs about the amount settled in the RTGS account, names the destination DCA and provides the originally instructed amount if deviating from settlement amount (possible in case of standing orders).

Precondition for the creation of the XML message is that the concerned account holder has opted to receive this message type instead of MT900.

The BankToCustomerDebitCreditNotification message will always be sent as "camt.054.001.06".

Structure:

BankToCustomerDebitCreditNotification	<BkToCstmrDbtCdtNfctn>
GroupHeader	<GrpHdr>
Message Identification	<MsgId></MsgId>
CreationDateTime	<CreDtTm></CreDtTm>
EndGroupHeader	</GrpHdr>
Notification	<Nfctn>
NotificationIdentification	<Id></Id>
CreationDateTime	<CreDtTm></CreDtTm>
Account Identification	<Acct>
Identification	<Id>
GenericAccountIdentification	<Othr>
Identification	<Id></Id>
End of GenericAccountIdentification	</Othr>
End Identification	</Id>
End of Account	</Acct>
Entry	<Ntry>
Amount	<Amt Ccy="EUR"></Amt>
Credit or debit indicator	<CdtDbtInd></CdtDbtInd>
Payment status	<Sts></Sts>
BookingDate	<BookgDt>
Date Time	<DtTm></DtTm>
End of BookingDate	</BookgDt>
BankTransactionCode	<BkTxCd>
Domain	<Domn>
DomainCode	<Cd></Cd>
Family	<Fmly>
FamilyCode	<Cd></Cd>
SubFamilyCode	<SubFmlyCd></SubFmlyCd>
End of Family	</Fmly>
End of Domain	</Domn>
End of BankTransactionCode	</BkTxCd>
EntryDetails	<NtryDtls>
TransactionDetails	<TxDtls>
References	<Refs>
AccountServicerReference	<AcctSvcrRef></AcctSvcrRef>
InstructionIdentification	<InstrId></InstrId>
EndToEndIdentification	<EndToEndId></EndToEndId>
AccountServicerTransactionID	<AcctSvcrTxId></AcctSvcrTxId>

End of References	</Refs>
Amount	<Amt Ccy="EUR"></Amt>
Credit or debit indicator	<CdtDbtInd></CdtDbtInd>
AmountDetails	<AmtDtls>
Instructed Amount	<InstdAmt>
Amount	<Amt Ccy="EUR"></Amt>
End Instructed Amount	</InstdAmt>
End of AmountDetails	</AmtDtls>
RelatedParties	<RltdPties>
CreditorAccount	<CdtrAcct>
Identification	<Id>
GenericAccountIdentification	<Othr>
Identification	<Id></Id>
End of GenericAccountIdentification	</Othr>
End Identification	</Id>
EndCreditorAccount	</CdtrAcct>
End of RelatedParties	</RltdPties>
End of TransactionDetails	</TxDtls>
End of EntryDetails	</NtryDtls>
End of Entry	</Ntry>
End of Notification	</Ntfctn>
End of BankToCustomerDebitCreditNotification	</BkToCstmrDbtCdtNtfctn>

Attributes:

name of attribute	format	short description	description
<BkToCstmrDbtCdtNtfctn>		BankToCustomerDebitCreditNotification Mandatory A2A	Validation: [1..1]
<GrpHdr>		GroupHeader Mandatory A2A	Validation: [1..1]
<MsgId></MsgId>	16x	Message Identification Mandatory A2A	String of characters that uniquely identifies a message Validation: [1..1]
<CreDtTm></CreDtTm>	ISODateTime	CreationDateTime Mandatory A2A	Date and time when the message has been created. Validation: [1..1]
</GrpHdr>		EndGroupHeader Mandatory A2A	Validation: [1..1]
<Ntfctn>		Notification Mandatory A2A	Validation: [1..1]
<Id></Id>	16x	NotificationIdentification Mandatory A2A	Validation: [1..1]
<CreDtTm></CreDtTm>	ISODateTime	CreationDateTime Mandatory A2A	Date and time when the message has been created. Validation: [1..1]
<Acct>		Account Identification Mandatory A2A	Account to or from which a cash entry is made Validation: [1..1]
<Id>		Identification Mandatory A2A	Validation: [1..1]
<Othr>		GenericAccountIdentification Mandatory A2A	GenericAccountIdentification Validation: [1..1]
<Id></Id>	34x	Identification Mandatory A2A	Name or number assigned by an entity to enable recognition of that entity, eg, account identifier. RTGS account number Validation: [1..1]
</Othr>		End of GenericAccountIdentification	End of GenericAccountIdentification

name of attribute	format	short description	description
		Mandatory A2A	Validation: [1..1]
</ld>		End Identification	End Identification
		Mandatory A2A	Validation: [1..1]
</Acct>		End of Account	End of Account
		Mandatory A2A	Validation: [1..1]
<Ntry>		Entry	Entry in the books.
		Mandatory A2A	Validation: [1..1]
<Amt Ccy="EUR"></Amt>	15d	Amount	Amount in EURO
		Mandatory A2A	Validation: [1..1]
<CdtDbtInd></CdtDbtInd>	4!a	Credit or debit indicator	
		Mandatory A2A	Validation: [1..1]
<Sts></Sts>	4!c	Payment status	Fixed value "BOOK". The notification is only sent after settlement.
		Mandatory A2A	Validation: [1..1]
<BookgDt>		BookingDate	
		Mandatory A2A	Validation: [1..1]
<DtTm></DtTm>	ISODateTime	Date Time	SSP Business Day + Settlement Time
		Mandatory A2A	Validation: [1..1]
</BookgDt>		End of BookingDate	
		Mandatory A2A	Validation: [1..1]
<BkTxCd>		BankTransactionCode	
		Mandatory A2A	Validation: [1..1]
<Domn>		Domain	
		Mandatory A2A	Validation: [1..1]
<Cd></Cd>	4!c	DomainCode	Fixed value "PMNT" (= payments area).
		Mandatory A2A	Validation: [1..1]
<Fmly>		Family	

name of attribute	format	short description	description
		Mandatory A2A	Validation: [1..1]
<Cd>-</Cd>	4!c	FamilyCode Mandatory A2A	Fixed value "ICDT" (=issued credit transfers) Validation: [1..1]
<SubFmlyCd>-</SubFmlyCd>	4!c	SubFamilyCode Mandatory A2A	Codes that may be used: "STDO" = standing order liquidity transfer "FICT" = current order financial institution credit transfer Validation: [1..1]
</Fmly>		End of Family Mandatory A2A	Validation: [1..1]
</Domn>		End of Domain Mandatory A2A	Validation: [1..1]
</BkTxCd>		End of BankTransactionCode Mandatory A2A	Validation: [1..1]
<NtryDtls>		EntryDetails Mandatory A2A	Validation: [1..1]
<TxDtls>		TransactionDetails Mandatory A2A	Validation: [1..1]
<Refs>		References Mandatory A2A	Validation: [1..1]
<AcctSvcrRef>-</AcctSvcrRef>	16x	AccountServicerReference Mandatory A2A	SSP Business Case ID Validation: [1..1]
<InstrId>-</InstrId>	16x	InstructionIdentification Mandatory A2A	Unique and unambiguous identifier for a payment instruction assigned by the initiating party Validation: [1..1]
<EndToEndId>-</EndToEndId>	16x	EndToEndIdentification Mandatory A2A	Unique and unambiguous identification of a payment transaction, as assigned by any of the parties on the initiating side, that will be passed on throughout the entire end-to-end chain Validation: [1..1]
<AcctSvcrTxId>-</AcctSvcrTxId>	16x	AccountServicerTransactionID Mandatory	SSP Booking ID Validation:

name of attribute	format	short description	description
		A2A	[1..1]
</Refs>		End of References	
		Mandatory	Validation: [1..1]
		A2A	[1..1]
<Amt Ccy="EUR"></Amt>	15d	Amount	Amount in EURO
		Mandatory	Validation: [1..1]
		A2A	[1..1]
<CdtDbtInd></CdtDbtInd>	4!a	Credit or debit indicator	CRDT = Credit Operation is an increase. DBIT = Debit Operation is a decrease. Only debit bookings notified by T2SI.
		Mandatory	Validation: [1..1]
		A2A	[1..1]
<AmtDtls>		AmountDetails	Only used in case of standing orders and only if partially executed.
		Optional	Validation: [0..1]
		A2A	[0..1]
<InstdAmt>		Instructed Amount	
		Mandatory	Validation: [1..1]
		A2A	[1..1]
<Amt Ccy="EUR"></Amt>	15d	Amount	Amount in EURO Standing order amount.
		Mandatory	Validation: [1..1]
		A2A	[1..1]
</InstdAmt>		End Instructed Amount	
		Mandatory	Validation: [1..1]
		A2A	[1..1]
</AmtDtls>		End of AmountDetails	
		Optional	Validation: [0..1]
		A2A	[0..1]
<RltdPties>		RelatedParties	
		Mandatory	Validation: [1..1]
		A2A	[1..1]
<CdtrAcct>		CreditorAccount	
		Mandatory	Validation: [1..1]
		A2A	[1..1]
<Id>		Identification	
		Mandatory	Validation: [1..1]
		A2A	[1..1]
<Othr>		GenericAccountIdentificatio n	GenericAccountIdentification
		Mandatory	Validation: [1..1]
		A2A	[1..1]

name of attribute	format	short description	description
<Id>-</Id>	34x	Identification	Name or number assigned by an entity to enable recognition of that entity, eg, account identifier. Counterpart DCA number
		Mandatory	Validation:
		A2A	[1..1]
</Othr>		End of GenericAccountIdentification	End of GenericAccountIdentification
		Mandatory	Validation:
		A2A	[1..1]
</Id>		End Identification	End Identification
		Mandatory	Validation:
		A2A	[1..1]
</CdrAcct>		EndCreditorAccount	
		Mandatory	Validation:
		A2A	[1..1]
</RltdPties>		End of RelatedParties	
		Mandatory	Validation:
		A2A	[1..1]
</TxDtls>		End of TransactionDetails	
		Mandatory	Validation:
		A2A	[1..1]
</NtryDtls>		End of EntryDetails	
		Mandatory	Validation:
		A2A	[1..1]
</Ntry>		End of Entry	
		Mandatory	Validation:
		A2A	[1..1]
</Ntfnct>		End of Notification	
		Mandatory	Validation:
		A2A	[1..1]
</BkToCstmrDbtCdtNtfnct>		End of BankToCustomerDebitCreditNotification	
		Mandatory	Validation:
		A2A	[1..1]

Error Codes:

BankToCustomerDebitCreditNotification_T2SI_1

Scope:

BankToCustomerDebitCreditNotification	<BkToCstmrDbtCdtNfctn>
GroupHeader	<GrpHdr>
Message Identification	<MsgId>1234567890123456</MsgId>
CreationDateTime	<CreDtTm>2014-11-11T08:20:15</CreDtTm>
EndGroupHeader	</GrpHdr>
Notification	<Ntfctn>
NotificationIdentification	<Id>1234567890123456</Id>
CreationDateTime	<CreDtTm>2014-11-11T08:20:15</CreDtTm>
Account Identification	<Acct>
Identification	<Id>
GenericAccountIdentification	<Othr>
NotificationIdentification	<Id>DE11RTGS0000123</Id>
End of GenericAccountIdentification	</Othr>
End Identification	</Id>
End of Account	</Acct>
Entry	<Ntry>
Amount	<Amt Ccy="EUR">1000000.00</Amt>
Credit or debit indicator	<CdtDbtInd>DBIT</CdtDbtInd>
Payment status	<Sts>BOOK</Sts>
BookingDate	<BookgDt>
Date Time	<CreDtTm>2014-11-11T20:20:15</CreDtTm>
End of BookingDate	</BookgDt>
BankTransactionCode	<BkTxCd>
Domain	<Domn>
DomainCode	<Cd>PMNT</Cd>
Family	<Fmly>
DomainCode	<Cd>ICDT</Cd>
SubFamilyCode	<SubFmlyCd>FICT</SubFmlyCd>
End of Family	</Fmly>
End of Domain	</Domn>
End of BankTransactionCode	</BkTxCd>
EntryDetails	<NtryDtls>
TransactionDetails	<TxDtls>
References	<Refs>
AccountServicerReference	<AcctSvcrRef>1234567</AcctSvcrRef>
InstructionIdentification	<InstrId>IID-001</InstrId>
EndToEndIdentification	<EndToEndId>E2E-001</EndToEndId>
AccountServicerTransactionID	<AcctSvcrTxId>1346789</AcctSvcrTxId>
End of References	</Refs>
Amount	<Amt Ccy="EUR">1000000.00</Amt>
Credit or debit indicator	<CdtDbtInd>DBIT</CdtDbtInd>
RelatedParties	<RltdPties>
CreditorAccount	<CdtrAcct>
Identification	<Id>
GenericAccountIdentification	<Othr>
NotificationIdentification	<Id>DE11DCA000012345</Id>
End of GenericAccountIdentification	</Othr>
End Identification	</Id>
EndCreditorAccount	</CdtrAcct>

End of RelatedParties					</RltdPties>
End of TransactionDetails					</TxDtIs>
End of EntryDetails					</NtryDtIs>
End of Entry					</Ntry>
End of Notification					</Ntfctn>
End of BankToCustomerDebitCreditNotification					</BkToCstmrDbtCdtNtfctn>

BankToCustomerDebitCreditNotification_T2SI_2

Scope: Notification about partially executed standing order liquidity transfer to T2S.

BankToCustomerDebitCreditNotification	<BkToCstmrDbtCdtNfctn>
GroupHeader	<GrpHdr>
Message Identification	<MsgId>1234567890123456</MsgId>
CreationDateTime	<CreDtTm>2015-02-06T19:35:55</CreDtTm>
EndGroupHeader	</GrpHdr>
Notification	<Nfctn>
NotificationIdentification	<Id>1234567890123456</Id>
CreationDateTime	<CreDtTm>2015-02-06T19:35:55</CreDtTm>
Account Identification	<Acct>
Identification	<Id>
GenericAccountIdentification	<Othr>
NotificationIdentification	<Id>DE11RTGS0000123</Id>
End of GenericAccountIdentification	</Othr>
End Identification	</Id>
End of Account	</Acct>
Entry	<Ntry>
Amount	<Amt Ccy="EUR">578901.25</Amt>
Credit or debit indicator	<CdtDbtInd>DBIT</CdtDbtInd>
Payment status	<Sts>BOOK</Sts>
BookingDate	<BookgDt>
Date Time	<DtTm>2015-02-09T19:35:05</DtTm>
End of BookingDate	</BookgDt>
BankTransactionCode	<BkTxCd>
Domain	<Domn>
DomainCode	<Cd>PMNT</Cd>
Family	<Fmly>
DomainCode	<Cd>ICDT</Cd>
SubFamilyCode	<SubFmlyCd>STDO</SubFmlyCd>
End of Family	</Fmly>
End of Domain	</Domn>
End of BankTransactionCode	</BkTxCd>
EntryDetails	<NtryDtls>
TransactionDetails	<TxDtls>
References	<Refs>
AccountServicerReference	<AcctSvcrRef>123456</AcctSvcrRef>
InstructionIdentification	<InstrId>134678</InstrId>
EndToEndIdentification	<EndToEndId>123456</EndToEndId>
AccountServicerTransactionID	<AcctSvcrTxId>134678</AcctSvcrTxId>
End of References	</Refs>
Amount	<Amt Ccy="EUR">578901.25</Amt>
Credit or debit indicator	<CdtDbtInd>DBIT</CdtDbtInd>
AmountDetails	<AmtDtls>
Instructed Amount	<InstdAmt>
Amount	<Amt Ccy="EUR">600000.00</Amt>
End Instructed Amount	</InstdAmt>
End of AmountDetails	</AmtDtls>
RelatedParties	<RltdPties>
CreditorAccount	<CdtrAcct>
Identification	<Id>

GenericAccountIdentification		<Othr>
NotificationIdentification		<Id>DE11DCA000012345</Id>
End of GenericAccountIdentification		</Othr>
End Identification		</Id>
EndCreditorAccount		</CdtrAcct>
End of RelatedParties		</RltdPties>
End of TransactionDetails		</TxDtls>
End of EntryDetails		</NtryDtls>
End of Entry		</Ntry>
End of Notification		</Ntfctn>
End of BankToCustomerDebitCreditNotification		</BkToCstmrDbtCdtNtfctn>

6.12. 2 CancelTransaction

Cash Management Standard

CancelTransaction_T2SI

M

Scope: The CancelTransaction_T2SI message is only introduced for the purpose of enabling "T2S Actors in TARGET2" (eg CSD) to revoke pending liquidity transfers to T2S. (As these users do not have access to ICM.) The sender must be the initiator of the liquidity transfer.
Other actors do have to use CancelTransaction_PM (processed via ICM) for the purpose.

T2SI only supports one version of order message CancelTransaction (DRAFT1camt.008.001.07).
The related response is a Receipt (DRAFT1camt.025.001.04) sent via T2SI in store-and-forward mode if an error is detected or after successful execution of the revocation.

Structure:

Message name for CancelTransaction	<CclTx>
Message Header	<MsgHdr>
Message Identification	<MsgId></MsgId>
End of Message Header	</MsgHdr>
PaymentIdentification	<PmtId>
Choice	xorLngBizIdPrtryId
LongBusinessIdentification	<LngBizId>
TransactionIdentification 16x	<TxId></TxId>
ImpliedCurrencyAndAmount	<IntrBkSttlmAmt></IntrBkSttlmAmt>
Value date	<IntrBkSttlmDt></IntrBkSttlmDt>
PaymentMethod	<PmtMtd>
ProprietaryPaymentOriginType	<Prtry></Prtry>
End of Payment Method	</PmtMtd>
Instructing Agent	<InstgAgt>
Financial Institution Identification	<FinInstnId>
BICFIIdentifier	<BICFI></BICFI>
End of Financial Institution Identification	</FinInstnId>
End of Instructing Agent	</InstgAgt>
Instructed Agent	<InstdAgt>
Financial Institution Identification	<FinInstnId>
BICFIIdentifier	<BICFI></BICFI>
End of Financial Institution Identification	</FinInstnId>
End of Instructed Agent	</InstdAgt>
EndToEndIdentification	<EndToEndId></EndToEndId>
End LongBusinessIdentification	</LngBizId>
ProprietaryId	<PrtryId></PrtryId>
End of choice	/xorLngBizIdPrtryId
EndPaymentIdentification	</PmtId>
End of Message name for CancelTransaction	</CclTx>

Attributes:

name of attribute	format	short description	description
<CcITx>		Message name for CancelTransaction Mandatory A2A	Validation: [1..1]
<MsgHdr>		Message Header Mandatory A2A	Set of characteristics specific to the message Validation: [1..1]
<MsgId>-</MsgId>	35x	Message Identification Mandatory A2A	Message Identification Validation: [1..1] MessageID has to be unique over all messages addressed to T2SI (independent of message types) for a period of 5 business days per RequestorDN.
</MsgHdr>		End of Message Header Mandatory A2A	Validation: [1..1]
<PmtId>		PaymentIdentification Mandatory A2A	Set of elements to provide further means of referencing a payment transaction Validation: [1..1]
xorLngBizIdPrtryId		Choice Optional	PaymentIdentificationChoice: Choice between <LngBizId> and <PrtryId> Validation:
<LngBizId>		LongBusinessIdentification Mandatory A2A	Identifies a payment instruction by a set of characteristics which provides an unambiguous identification of the instruction. TransactionIdentification InterBankSettlementAmount InterBankSettlementDate PaymentMethod InstructingAgent InstructedAgent EndToEndIdentification Validation: [1..1]
<TxId>-</TxId>	16x	TransactionIdentification 16x Mandatory A2A	Unique and unambiguous identification of a payment transaction, as assigned by the originator. The payment transaction reference is used for reconciliation or to link tasks relating to the payment transaction. TransactionIdentification of the LiquidityCreditTransfer message. Validation: [1..1]
<IntrBkSttlmAmt>-</IntrBkSttlmAmt>		ImpliedCurrencyAndAmount Mandatory A2A	ImpliedCurrencyAndAmount EUR amount requested for settlement in the LiquidityCreditTransfer message. Validation: [1..1]
<IntrBkSttlmDt>-</IntrBkSttlmDt>	ISODate	Value date Mandatory	Value date Validation:

name of attribute	format	short description	description
		A2A	[1..1]
<PmtMtd>		PaymentMethod	PaymentMethod
		Mandatory	Validation: [1..1]
		A2A	[1..1]
<Prtry>-</Prtry>	6c	ProprietaryPaymentOriginType	ASXML = Bookings stemming from incoming AS XML payments T2SXML = Bookings stemming from incoming T2S XML payments T2SXML = Bookings stemming from incoming TIPS XML payments INTERN = Bookings stemming from internal messages ORDER = Bookings stemming from current orders sent via ICM Only value "T2SXML" possible. Other payment messages cannot be sent by T2S actors in TARGET2.
		Mandatory	Validation: [1..1]
		A2A	[1..1]
</PmtMtd>		End of Payment Method	End of Payment Method
		Mandatory	Validation: [1..1]
		A2A	[1..1]
<InstgAgt>		Instructing Agent	Instructing Agent Sender of payment message.
		Mandatory	Validation: [1..1]
		A2A	[1..1]
<FinInstnId>		Financial Institution Identification	Financial Institution Identification
		Mandatory	Validation: [1..1]
		A2A	[1..1]
<BICFI>-</BICFI>	4!a2!a2!c3!c	BICFIIdentifier	BICFIIdentifier RTGS debit account BIC.
		Mandatory	Validation: [1..1]
		A2A	[1..1]
</FinInstnId>		End of Financial Institution Identification	End of Financial Institution Identification
		Mandatory	Validation: [1..1]
		A2A	[1..1]
</InstgAgt>		End of Instructing Agent	End of Instructing Agent
		Mandatory	Validation: [1..1]
		A2A	[1..1]
<InstdAgt>		Instructed Agent	Instructed Agent Receiver of the payment message.
		Mandatory	Validation: [1..1]
		A2A	[1..1]
<FinInstnId>		Financial Institution Identification	Financial Institution Identification
		Mandatory	Validation: [1..1]
		A2A	[1..1]

name of attribute	format	short description	description
<BICFI>-</BICFI>	4!a2!a2!c3!c	BICFIIdentifier	BICFIIdentifier BIC of PM: "TRGTXEPM2S"
		Mandatory	Validation:
		A2A	[1..1]
</FinInstnId>		End of Financial Institution Identification	End of Financial Institution Identification
		Mandatory	Validation:
		A2A	[1..1]
</InstdAgt>		End of Instructed Agent	End of Instructed Agent
		Mandatory	Validation:
		A2A	[1..1]
<EndToEndId>-</EndToEndId>	16x	EndToEndIdentification	Unique and unambiguous identification of a payment transaction, as assigned by any of the parties on the initiating side, that will be passed on throughout the entire end-to-end chain
		Mandatory	Validation:
		A2A	[1..1]
</LngBizId>		End LongBusinessIdentification	End LongBusinessIdentification
		Mandatory	Validation:
		A2A	[1..1]
<PrtryId>-</PrtryId>	16n	ProprietaryId	ProprietaryId SSP Booking ID
			This can used if it is known by the requestor. Eg because he has previously checked the payment status by sending GetTransaction request.
		Mandatory	Validation:
		A2A	[1..1]
/xorLngBizIdPrtryId		End of choice	End of PaymentIdentificationChoice
		Optional	Validation:
</PmtId>		EndPaymentIdentification	End of Set of elements to reference a payment transaction
		Mandatory	Validation:
		A2A	[1..1]
</CclTx>		End of Messagename for CancelTransaction	
		Mandatory	Validation:
		A2A	[1..1]

Error Codes:

Order	Error code				Error Text / Validation/ Remark
	SSP	Y-copy	V-shape	XML	
1	X00			0000	Error Text: O.k. Validation: Confirmation that the order has been successfully executed. The indicated liquidity transfer has been revoked. Remark:
2	X57			1417	Error Text: Requestor DN not found in the DN matching table Validation: RequestorDN must be linked to a SSP participant. An active record in DN-BIC matching table is needed. Remark:
3	X63			1423	Error Text: No authorisation. Requestor is no PM participant. Validation: RequestorDN must match to a PM participant. Remark:
6	X58			1406	Error Text: No authorisation. User is not allowed acting on behalf of another participant as T2S Actor in TARGET2. Validation: Actor type of DN-BIC record must be "T2S Actor in TARGET2" Remark:
7	X71			1431	Error Text: This request type has to be sent in store-and-forward mode. Validation: Message must be sent in store-and-forward mode. Remark:
8	X44			1404	Error Text: If "non repudiation of emission" is mandatory, the NRE indicator flag has to be present Validation: Non repudiation of emission service from SWIFT has to be used. Remark:
9	T40			T040	Error Text: Double Message Identification. Validation: MessageID has to be unique over all messages (independent of message types) for a period of 5 business days per RequestorDN. Remark:
10	862	C2	TM01	2862	Error Text: Request out of cut-off time Validation: The request has to be sent within a TARGET2 settlement phase. Remark:
11	P13			P013	Error Text: No payment found Validation: The payment identification must refer to a payment available in PM booking table. Remark:
12	P71			P101	Error Text: You are not allowed to revoke the payment(s) Validation: The participant the requestor is working for must not be excluded. Remark:
13	P71			P101	Error Text: You are not allowed to revoke the payment(s) Validation: The payment identification must refer to a queued liquidity transfer initiated via XML message that has been sent with the same Requestor DN. Remark:

CancelTransaction_T2SI_1

Scope: Revoke a liquidity transfer identified via LongBusinessIdentification.

MessageName for CancelTransaction	<CclTx>
Message Header	<MsgHdr>
Message Identification	<MsgId>ABC123</MsgId>
End of Message Header	</MsgHdr>
PaymentIdentification	<PmtId>
LongBusinessIdentification	<LngBizId>
TransactionIdentification 16x	<TxId>ABCD1234</TxId>
ImpliedCurrencyAndAmount	<IntrBkSttlmAmt>1000000.95</IntrBkSttlmAmt>
Value date	<IntrBkSttlmDt>2014-11-11</IntrBkSttlmDt>
PaymentMethod	<PmtMtd>
ProprietaryPaymentOriginType	<Prtry>T2SXML</Prtry>
End of Payment Method	</PmtMtd>
Instructing Agent	<InstgAgt>
Financial Institution Identification	<FinInstnId>
BICFIIdentifier	<BICFI>MARKDEFFXXX</BICFI>
End of Financial Institution Identification	</FinInstnId>
End of Instructing Agent	</InstgAgt>
Instructed Agent	<InstdAgt>
Financial Institution Identification	<FinInstnId>
BICFIIdentifier	<BICFI>TRGTXEPM2S</BICFI>
End of Financial Institution Identification	</FinInstnId>
End of Instructed Agent	</InstdAgt>
EndToEndIdentification	<EndToEndId>ABC12134</EndToEndId>
End LongBusinessIdentification	</LngBizId>
EndPaymentIdentification	</PmtId>
End of MessageName for CancelTransaction	</CclTx>

CancelTransaction_T2SI_2

Scope: Revoke a liquidity transfer identified via SSP Booking ID.

MessageName for CancelTransaction	<CclTx>
Message Header	<MsgHdr>
Message Identification	<MsgId>ABC123</MsgId>
End of Message Header	</MsgHdr>
PaymentIdentification	<PmtId>
ProprietaryId	<PrtryId>1294354</PrtryId>
EndPaymentIdentification	</PmtId>
End of MessageName for CancelTransaction	</CclTx>

6.12. 3 GetAccount

Cash Management Standard

GetAccount_T2SI

M

Scope: The GetAccount message is used to receive DCA balance information from T2S.

Only information of EURO DCAs linked within T2S to the RTGS account of the requesting direct PM participant can be asked. In addition, the requestor may also be a GoA manager or the CB of the RTGS account holder working on behalf of the participant.

The requestor must have opted for usage of value added services for T2S.

T2SI only supports one version of request message GetAccount (DRAFT1camt.003.001.06).
The related query response message is ReturnAccount (DRAFT1camt.004.001.07).

Structure:

Message Type	<GetAcct>
Message Header	<MsgHdr>
Message Identification	<MsgId></MsgId>
End of Message Header	</MsgHdr>
Account Query Definition	<AcctQryDef>
AccountCriteria	<AcctCrit>
NewCriteria	<NewCrit>
SearchCriteria	<SchCrit>
Account Identification	<AcctId>
AccountIdentificationChoice	<EQ>
GenericAccountIdentification	<Othr>
Identification	<Id></Id>
End of GenericAccountIdentification	</Othr>
End of AccountIdentificationChoice	</EQ>
End of Account Identification	</AcctId>
Account Owner	<AcctOwnr>
Identification	<Id>
OrganisationIdentification	<OrgId>
AnyBICIdentifier	<AnyBIC></AnyBIC>
End of OrganisationIdentification	</OrgId>
End Identification	</Id>
End of Account owner	</AcctOwnr>
End of SearchCriteria	</SchCrit>
End of NewCriteria	</NewCrit>
End of AccountCriteria	</AcctCrit>
End of AccountQueryDefinition	</AcctQryDef>
End of Message Type	</GetAcct>

Attributes:

name of attribute	format	short description	description
<GetAcct>		Message Type	Message name for GetAccount
		Mandatory	Validation:
		A2A	[1..1]
<MsgHdr>		Message Header	Set of characteristics specific to the message
		Mandatory	Validation:
		A2A	[1..1]
<MsgId>-</MsgId>	35x	Message Identification	Message Identification
		Mandatory	Validation:
		A2A	[1..1] MessageID has to be unique over all messages addressed to T2SI (independent of message types) for a period of 5 business days per RequestorDN.
</MsgHdr>		End of Message Header	
		Mandatory	Validation:
		A2A	[1..1]
<AcctQryDef>		Account Query Definition	Specification of the query criteria.
		Mandatory	Validation:
		A2A	[1..1]
<AcctCrit>		AccountCriteria	Definition of the account query criteria.
		Mandatory	Validation:
		A2A	[1..1]
<NewCrit>		NewCriteria	Defines the criteria based on which the information is extracted.
		Mandatory	Validation:
		A2A	[1..1]
<SchCrit>		SearchCriteria	
		Mandatory	Validation:
		A2A	[1..1]
<AcctId>		Account Identification	Unique and unambiguous identification for the account between the account owner and the account servicer. Balances of several DCAs may be asked with one request.
		Mandatory	Validation:
		A2A	[1..n]
<EQ>		AccountIdentificationChoice	AccountIdentificationChoice
		Mandatory	Validation:
		A2A	[1..1]
<Othr>		GenericAccountIdentificatio n	GenericAccountIdentification
		Mandatory	Validation:
		A2A	[1..1]
<Id>-</Id>	34x	Identification	Name or number assigned by an entity to enable recognition of that entity, eg, account identifier.

name of attribute	format	short description	description
		Mandatory A2A	Validation: [1..1]DCA ID has to be linked within T2S to the RTGS account holder BIC.
</Othr>		End of GenericAccountIdentification Mandatory A2A	End of GenericAccountIdentification Validation: [1..1]
</EQ>		End of AccountIdentificationChoice Mandatory A2A	End of search for one or more accounts based on exact identification of the account(s). Validation: [1..1]
</AcctId>		End of Account Identification Mandatory A2A	Validation: [1..1]
<AcctOwnr>		Account Owner Optional A2A	Used to identify an RTGS account holder the requestor is working on behalf of. Validation: [0..1]
<Id>		Identification Mandatory A2A	Identification Unique and unambiguous identification for the account between the account owner and the account servicer. Validation: [1..1]
<OrgId>		OrganisationIdentification Mandatory A2A	OrganisationIdentification Validation: [1..1]
<AnyBIC>-</AnyBIC>	4!a2!a2!c[3!cAnyBICIdentifier]	Mandatory A2A	AnyBICIdentifier / BIC used on behalf of third parties Validation: [1..1]Must be the BIC of an active RTGS account.
</OrgId>		End of OrganisationIdentification Mandatory A2A	End of OrganisationIdentification Validation: [1..1]
</Id>		End Identification Mandatory A2A	Validation: [1..1]
</AcctOwnr>		End of Account owner Optional A2A	Validation: [0..1]
</SchCrit>		End of SearchCriteria Mandatory A2A	End of SearchCriteria Validation: [1..1]

name of attribute	format	short description	description
</NewCrit>		End of NewCriteria	End of NewCriteria
		Mandatory	Validation:
	A2A		[1..1]
</AcctCrit>		End of AccountCriteria	End of AccountCriteria
		Mandatory	Validation:
	A2A		[1..1]
</AcctQryDef>		End of AccountQueryDefinition	End of AccountQueryDefinition
		Mandatory	Validation:
	A2A		[1..1]
</GetAcct>		End of Message Type	End of GetAccount
		Mandatory	Validation:
	A2A		[1..1]

Error Codes:

Order	Error code				Error Text / Validation/ Remark
	SSP	Y-copy	V-shape	XML	
1	X41			1401	Error Text: No permission. RBAC User role(s) are not sufficient. Validation: RBAC role APPLICATE or APPLICBTE is required Remark:
2	X49			1409	Error Text: No permission. At least one RBAC role is reserved in U2A mode only but used in A2A Validation: Requestor must not have U2A user role. Remark:
3	X55			1415	Error Text: A combination of different A2A roles is not allowed. Validation: A combination of different A2A roles is not allowed. Remark:
4	X70			1430	Error Text: This request type has to be sent in real-time mode. Validation: Query must be sent in real-time mode. Remark:
5	X57			1417	Error Text: Requestor DN not found in the DN matching table Validation: RequestorDN must be linked to a SSP participant. An active record in DN-BIC matching table is needed. Remark:
6	X42			1402	Error Text: No authorisation. User is not allowed acting on behalf of another participant. Validation: AcctOwnr (profile credit institution) value may only indicate an RTGS account that belongs to the credit institution itself. Remark:
7	X45			1405	Error Text: No authorisation or rather interaction not possible. User is not allowed acting on behalf of another participant as Group of Account manager Validation: AcctOwnr (profile group of account manager) value must indicate a member of the group of accounts the participant is the manager of. Remark:
8	X47			1407	Error Text: No authorisation. User is not allowed acting on behalf of another Participant as Central Bank Validation: AcctOwnr (profile central bank) value must indicate an account that belongs to the CB itself or to a participant the CB is responsible for. Remark:
9	X62	TL		1422	Error Text: The DCA must be linked to a RTGS account related to the sender. Validation: The indicated DCA must be linked to the requesting PM participant or in case of "on behalf scenario" the DCA(s) must be linked to the given AcctOwnr. Remark:
10	T10	TV		T010	Error Text: T2S related value added service package required. Validation: The requestor must have opted for usage of value added services for T2S. Remark:
11	T40			T040	Error Text: Double Message Identification. Validation: The MessageID has to be unique over all messages addressed to T2SI (independent of message types) for a period of 5 business

Order	Error code				Error Text / Validation/ Remark
	SSP	Y-copy	V-shape	XML	

days per RequestorDN.

Remark:

GetAccount_T2SI_1

Scope: Request for DCA balances of a single account sent by the RTGS account holder.

Message Type	<GetAcct>
Message Header	<MsgHdr>
Message Identification	<MsgId>ABC123</MsgId>
End of Message Header	</MsgHdr>
Account Query Definition	<AcctQryDef>
AccountCriteria	<AcctCrit>
NewCriteria	<NewCrit>
SearchCriteria	<SchCrit>
Account Identification	<AcctId>
AccountIdentificationChoice	<EQ>
GenericAccountIdentification	<Othr>
Identification	<Id>DE11DCA0000123</Id>
End of GenericAccountIdentification	</Othr>
End of AccountIdentificationChoice	</EQ>
End of Account Identification	</AcctId>
End of SearchCriteria	</SchCrit>
End of NewCriteria	</NewCrit>
End of AccountCriteria	</AcctCrit>
End of AccountQueryDefinition	</AcctQryDef>
End of Message Type	</GetAcct>

GetAccount_T2SI_2

Scope: Request of a GoA manager to get DCA balances of different accounts linked to a group member's RTGS account.

Message Type	<GetAcct>
Message Header	<MsgHdr>
Message Identification	<MsgId>ABC123</MsgId>
End of Message Header	</MsgHdr>
Account Query Definition	<AcctQryDef>
AccountCriteria	<AcctCrit>
NewCriteria	<NewCrit>
SearchCriteria	<SchCrit>
Account Identification	<AcctId>
AccountIdentificationChoice	<EQ>
GenericAccountIdentification	<Othr>
Identification	<Id>DE11DCA0000123</Id>
End of GenericAccountIdentification	</Othr>
End of AccountIdentificationChoice	</EQ>
End of Account Identification	</AcctId>
Account Identification	<AcctId>
AccountIdentificationChoice	<EQ>
GenericAccountIdentification	<Othr>
Identification	<Id>DE11DCA0000123</Id>
End of GenericAccountIdentification	</Othr>
End of AccountIdentificationChoice	</EQ>
End of Account Identification	</AcctId>
Account Owner	<AcctOwnr>
Identification	<Id>
OrganisationIdentification	<OrgId>
AnyBICIdentifier	<AnyBIC>DEUTDEFFXXX</AnyBIC>
End of OrganisationIdentification	</OrgId>
End Identification	</Id>
End of Account owner	</AcctOwnr>
End of SearchCriteria	</SchCrit>
End of NewCriteria	</NewCrit>
End of AccountCriteria	</AcctCrit>
End of AccountQueryDefinition	</AcctQryDef>
End of Message Type	</GetAcct>

6.12. 4 GetTransaction

Cash Management Standard

GetTransaction_T2SI

M

Scope: The GetTransaction_T2SI message is only introduced for the purpose of enabling "T2S Actors in TARGET2" (eg CSD) to check the status of a liquidity transfers to T2S, eg in case they miss the related Receipt. (As these users do not have access to ICM.) The sender must be the initiator of the liquidity transfer to get the information. Other actors do have to use GetTransaction_PM (processed via ICM) for the same purpose.

T2SI only supports one version of query message GetTransaction (DRAFT1camt.005.001.07).
The related response is a ReturnTransaction (DARFT1camt.006.001.07).

Structure:

Message name for GetTransaction	<GetTx>
Message Header	<MsgHdr>
Message Identification	<MsgId></MsgId>
End of Message Header	</MsgHdr>
Transaction Query Definition	<TxQryDef>
Transaction Criteria	<TxCrit>
NewCriteria	<NewCrit>
SearchCriteria	<SchCrit>
Payment Search	<PmtSch>
Choice	xorPmtIdSts
PaymentIdentification	<PmtId>
Choice	xorLngBizIdPrtryId
LongBusinessIdentification	<LngBizId>
TransactionIdentification 16x	<TxId></TxId>
ImpliedCurrencyAndAmount	<IntrBkSttlmAmt></IntrBkSttlmAmt>
Value date	<IntrBkSttlmDt></IntrBkSttlmDt>
PaymentMethod	<PmtMtd>
ProprietaryPaymentOriginType	<Prtry></Prtry>
End of Payment Method	</PmtMtd>
Instructing Agent	<InstgAgt>
Financial Institution Identification	<FinInstnId>
BICFIIdentifier	<BICFI></BICFI>
End of Financial Institution Identification	</FinInstnId>
End of Instructing Agent	</InstgAgt>
Instructed Agent	<InstdAgt>
Financial Institution Identification	<FinInstnId>
BICFIIdentifier	<BICFI></BICFI>
End of Financial Institution Identification	</FinInstnId>
End of Instructed Agent	</InstdAgt>
EndToEndIdentification	<EndToEndId></EndToEndId>
End LongBusinessIdentification	</LngBizId>
ProprietaryId	<PrtryId></PrtryId>
End of choice	/xorLngBizIdPrtryId
EndPaymentIdentification	</PmtId>
PaymentStatus	<Sts>
PaymentStatusCode	<PmtInstrSts>
PendingAndFinalStatus	<PdgAndFnlSts></PdgAndFnlSts>
End PaymentStatusCode	</PmtInstrSts>
End of PaymentStatus	</Sts>
End of choice	/xorPmtIdSts
End of PaymentSearch	</PmtSch>
End of SearchCriteria	</SchCrit>

End of NewCriteria				</NewCrit>
End of Transaction query criteria.				</TxCrit>
End of Transaction query definition				</TxQryDef>
End of Messagename for GetTransaction				</GetTx>

Attributes:

name of attribute	format	short description	description
<GetTx>		Message name for GetTransaction Mandatory A2A	Message name for GetTransaction Validation: [1..1]
<MsgHdr>		Message Header Mandatory A2A	Set of characteristics specific to the message Validation: [1..1]
<MsgId>-</MsgId>	35x	Message Identification Mandatory A2A	Message Identification Validation: [1..1]
</MsgHdr>		End of Message Header Mandatory A2A	Validation: [1..1]
<TxQryDef>		Transaction Query Definition Optional A2A	Validation: [0..1]
<TxCrit>		Transaction Criteria Mandatory A2A	Validation: [1..1]
<NewCrit>		NewCriteria Mandatory A2A	Defines the criteria based on which the information is extracted. Validation: [1..1]
<SchCrit>		SearchCriteria Mandatory A2A	Validation: [1..1]
<PmtSch>		Payment Search Mandatory A2A	Validation: [1..1]
xorPmtIdSts		Choice Optional	Choice between PaymentIdentification and PaymentStatus Requestor may ask information about a single payment or all payments with either pending or final status. Validation:
<PmtId>		PaymentIdentification Mandatory A2A	Set of elements to provide further means of referencing a payment transaction Validation: [1..1]
xorLngBizIdPrtryId		Choice Optional	PaymentIdentificationChoice: Choice between <LngBizId> and <PrtryId> Validation:
<LngBizId>		LongBusinessIdentification	Identifies a payment instruction by a set of characteristics

name of attribute	format	short description	description
			which provides an unambiguous identification of the instruction. TransactionIdentification InterBankSettlementAmount InterBankSettlementDate PaymentMethod InstructingAgent InstructedAgent EndToEndIdentification
		Mandatory A2A	Validation: [1..1]
<TxId>-</TxId>	16x	TransactionIdentification 16x	Unique and unambiguous identification of a payment transaction, as assigned by the originator. The payment transaction reference is used for reconciliation or to link tasks relating to the payment transaction.
		Mandatory A2A	Validation: [1..1]
<IntrBkSttlmAmt>-</IntrBkSttlmAmt>		ImpliedCurrencyAndAmount	ImpliedCurrencyAndAmount
		Mandatory A2A	Validation: [1..1]
<IntrBkSttlmDt>-</IntrBkSttlmDt>	ISODate	Value date	Value date
		Mandatory A2A	Validation: [1..1]
<PmtMtd>		PaymentMethod	PaymentMethod
		Mandatory A2A	Validation: [1..1]
<Prtry>-</Prtry>	6c	ProprietaryPaymentOriginType	ASXML = Bookings stemming from incoming AS XML payments T2SXML = Bookings stemming from incoming T2S XML payments T2SXML = Bookings stemming from incoming TIPS XML payments INTERN = Bookings stemming from internal messages ORDER = Bookings stemming from current orders sent via ICM
		Mandatory A2A	Validation: [1..1]
</PmtMtd>		End of Payment Method	End of Payment Method
		Mandatory A2A	Validation: [1..1]
<InstgAgt>		Instructing Agent	Instructing Agent Sender of payment message.
		Mandatory A2A	Validation: [1..1]
<FinInstnId>		Financial Institution Identification	Financial Institution Identification
		Mandatory A2A	Validation: [1..1]
<BICFI>-</BICFI>	4!a2!a2!c3!c	BICFIIdentifier	BICFIIdentifier RTGS debit account BIC.

name of attribute	format	short description	description
		Mandatory A2A	Validation: [1..1]
</FinInstnId>		End of Financial Institution Identification Mandatory A2A	End of Financial Institution Identification Validation: [1..1]
</InstgAgt>		End of Instructing Agent Mandatory A2A	End of Instructing Agent Validation: [1..1]
<InstdAgt>		Instructed Agent Mandatory A2A	Instructed Agent Receiver of the payment message. Validation: [1..1]
<FinInstnId>		Financial Institution Identification Mandatory A2A	Financial Institution Identification Validation: [1..1]
<BICFI>-</BICFI>	4!a2!a2!c3!c	BICFIIdentifier Mandatory A2A	BICFIIdentifier BIC of PM: "TRGTXEPMT2S" Validation: [1..1]
</FinInstnId>		End of Financial Institution Identification Mandatory A2A	End of Financial Institution Identification Validation: [1..1]
</InstdAgt>		End of Instructed Agent Mandatory A2A	End of Instructed Agent Validation: [1..1]
<EndToEndId>-</EndToEndId>	16x	EndToEndIdentification Mandatory A2A	Unique and unambiguous identification of a payment transaction, as assigned by any of the parties on the initiating side, that will be passed on throughout the entire end-to-end chain Validation: [1..1]
</LngBizId>		End LongBusinessIdentification Mandatory A2A	End LongBusinessIdentification Validation: [1..1]
<PrtryId>-</PrtryId>	16n	ProprietaryId Mandatory A2A	ProprietaryId Validation: [1..1]
/xorLngBizIdPrtryId		End of choice Optional	End of PaymentIdentificationChoice Validation:
</PmtId>		EndPaymentIdentification	End of Set of elements to reference a payment transaction

name of attribute	format	short description	description
		Optional	Validation:
<Sts>		PaymentStatus	
		Mandatory	Validation:
		A2A	[1..1]
<PmtInstrSts>		PaymentStatusCode	
		Mandatory	Validation:
		A2A	[1..1]
<PdgAndFnlSts>- </PdgAndFnlSts>		PendingAndFinalStatus	State of a payment instruction at a specified time. FINL = Final The payment has been settled or stopped. PDNG = Pending The payment is awaiting settlement.
		Mandatory	Validation:
		A2A	[1..1]
</PmtInstrSts>		End PaymentStatusCode	End PaymentStatusCode
		Mandatory	Validation:
		A2A	[1..1]
</Sts>		End of PaymentStatus	
		Mandatory	Validation:
		A2A	[1..1]
/xorPmtldSts		End of choice	
		Optional	Validation:
</PmtSch>		End of PaymentSearch	End of PaymentSearch
		Mandatory	Validation:
		A2A	[1..1]
</SchCrit>		End of SearchCriteria	End of SearchCriteria
		Mandatory	Validation:
		A2A	[1..1]
</NewCrit>		End of NewCriteria	End of NewCriteria
		Mandatory	Validation:
		A2A	[1..1]
</TxCrit>		End of Transaction query criteria.	
		Mandatory	Validation:
		A2A	[1..1]
</TxQryDef>		End of Transaction query definition	
		Optional	Validation:
		A2A	[0..1]
</GetTx>		End of Messagename for GetTransaction	
		Mandatory	Validation:

name of attribute	format	short description	description
		A2A	[1..1]

Error Codes:

Order	Error code				Error Text / Validation/ Remark
	SSP	Y-copy	V-shape	XML	
1	X41			1401	Error Text: No permission. RBAC User role(s) are not sufficient. Validation: RBAC role APPLICDTE is required Remark:
2	X49			1409	Error Text: No permission. At least one RBAC role is reserved in U2A mode only but used in A2A Validation: Requestor must not have U2A user role. Remark:
3	X55			1415	Error Text: A combination of different A2A roles is not allowed. Validation: A combination of different A2A roles is not allowed. Remark:
4	X57			1417	Error Text: Requestor DN not found in the DN matching table Validation: RequestorDN must be linked to a SSP participant. An active record in DN-BIC matching table is needed. Remark:
5	X58			1406	Error Text: No authorisation. User is not allowed acting on behalf of another participant as T2S Actor in TARGET2. Validation: Actor type of DN-BIC record must be "T2S Actor in TARGET2" Remark:
6	X70			1430	Error Text: This request type has to be sent in real-time mode. Validation: Query must be sent in real-time mode. Remark:
7	T40			T040	Error Text: Double Message Identification. Validation: The MessageID has to be unique over all messages addressed to T2SI (independent of message types) for a period of 5 business days per RequestorDN. Remark:
8	P13			P013	Error Text: No payment found Validation: A valid (!) and accurate payment message has to be sent by the requestor himself (same RequestorDN). If a "works as" BIC is mentioned in the ApplicationHeader the payment(s) must be related to this account. And if further filter criteria are given (PaymentIdentification or payment status) there must be a matching payment. Remark:

GetTransaction_T2SI_1

Scope: The requestor asks for information about all liquidity transfers he has sent.

Message name for GetTransaction	<GetTx>
Message Header	<MsgHdr>
Message Identification	<MsgId>ABC123</MsgId>
End of Message Header	</MsgHdr>
End of Message name for GetTransaction	</GetTx>

GetTransaction_T2SI_2

Scope: The requestor asks for information about a single liquidity transfer identified via LongBusinessIdentification.

MessageName for GetTransaction	<GetTx>
Message Header	<MsgHdr>
Message Identification	<MsgId>ABC123</MsgId>
End of Message Header	</MsgHdr>
Transaction Query Definition	<TxQryDef>
Transaction Criteria	<TxCrit>
NewCriteria	<NewCrit>
SearchCriteria	<SchCrit>
Payment Search	<PmtSch>
PaymentIdentification	<PmtId>
LongBusinessIdentification	<LngBizId>
TransactionIdentification 16x	<TxId>ABCD1234</TxId>
ImpliedCurrencyAndAmount	<IntrBkSttlmAmt>1000000.95</IntrBkSttlmAmt>
Value date	<IntrBkSttlmDt>2014-11-11</IntrBkSttlmDt>
PaymentMethod	<PmtMtd>
ProprietaryPaymentOriginType	<Prtry>T2SXML</Prtry>
End of Payment Method	</PmtMtd>
Instructing Agent	<InstgAgt>
Financial Institution Identification	<FinInstnId>
BICFIIdentifier	<BICFI>MARKDEFFXXX</BICFI>
End of Financial Institution Identification	</FinInstnId>
End of Instructing Agent	</InstgAgt>
Instructed Agent	<InstdAgt>
Financial Institution Identification	<FinInstnId>
BICFIIdentifier	<BICFI>TRGTXEPM2S</BICFI>
End of Financial Institution Identification	</FinInstnId>
End of Instructed Agent	</InstdAgt>
EndToEndIdentification	<EndToEndId>ABC12134</EndToEndId>
End LongBusinessIdentification	</LngBizId>
EndPaymentIdentification	</PmtId>
End of PaymentSearch	</PmtSch>
End of SearchCriteria	</SchCrit>
End of NewCriteria	</NewCrit>
End of Transaction query criteria.	</TxCrit>
End of Transaction query definition	</TxQryDef>
End of MessageName for GetTransaction	</GetTx>

GetTransaction_T2SI_3

Scope: The requestor asks for information about all liquidity transfers he has sent which still have pending status.

Messagename for GetTransaction	<GetTx>
Message Header	<MsgHdr>
Message Identification	<MsgId>ABC123</MsgId>
End of Message Header	</MsgHdr>
Transaction Query Definition	<TxQryDef>
Transaction Criteria	<TxCrit>
NewCriteria	<NewCrit>
SearchCriteria	<SchCrit>
Payment Search	<PmtSch>
PaymentStatus	<Sts>
PaymentStatusCode	<PmtInstrSts>
PendingAndFinalStatus	<PdgAndFnlSts>PDNG</PdgAndFnlSts>
End PaymentStatusCode	</PmtInstrSts>
End of PaymentStatus	</Sts>
End of PaymentSearch	</PmtSch>
End of SearchCriteria	</SchCrit>
End of NewCriteria	</NewCrit>
End of Transaction query criteria.	</TxCrit>
End of Transaction query definition	</TxQryDef>
End of Messagename for GetTransaction	</GetTx>

6.12. 5 LiquidityCreditTransfer

Cash Management Standard

LiquidityCreditTransfer_T2SI

M

Scope: The LiquidityCreditTransfer message can only be sent in Store-and-Forward mode to T2SI.

The message may be sent by:

- 1) Direct PM participants for own account,
- 2) CB on behalf of a participant being responsible for.

Both T2 actors can initiate liquidity transfers to T2S and from T2S via the message to TARGET2.

3) T2S Actors in TARGET2 (eg CSDs) authorised by the account owner and

4) Managers of group of accounts on behalf of their group members.

Both can only initiate liquidity transfers to T2S.

The message will be pushed in store-and-forward mode to the credit account holder in case of incoming liquidity transfers from T2S. This can have its origin in

- a current order,
- standing or predefined order
- or automatic retransfer at EoD.

(No additional credit notification will be sent in these cases.)

The only standard supported by T2SI is "DRAFT1camt.050.001.04".

Structure:

Message name for LiquidityCreditTransfer	<LqdyCdtTrf>
Message Header	<MsgHdr>
Message Identification	<MsgId></MsgId>
End of Message Header	</MsgHdr>
LiquidityCreditTransfer1	<LqdyCdtTrf>
LiquidityTransferIdentification	<LqdyTrfId>
InstructionIdentification	<InstrId></InstrId>
EndToEndIdentification	<EndToEndId></EndToEndId>
End of LiquidityTransferIdentification	</LqdyTrfId>
CreditorAccount	<CdtrAcct>
Identification	<Id>
GenericAccountIdentification	<Othr>
Identification	<Id></Id>
End of GenericAccountIdentification	</Othr>
End Identification	</Id>
CashAccountType	<Tp>
CashAccountTypeCode	<Cd></Cd>
End of CashAccountType	</Tp>
EndCreditorAccount	</CdtrAcct>
Transferred Amount	<TrfdAmt>
AmountWithoutCurrency	<AmtWthtCcy></AmtWthtCcy>
End of Transferred Amount	</TrfdAmt>
DebtorAccount	<DbtrAcct>
Identification	<Id>
GenericAccountIdentification	<Othr>
Identification	<Id></Id>
End of GenericAccountIdentification	</Othr>
End Identification	</Id>
CashAccountType	<Tp>
CashAccountTypeCode	<Cd></Cd>
End of CashAccountType	</Tp>
EndDebtorAccount	</DbtrAcct>
SettlementDate	<SttlmDt></SttlmDt>
End of LiquidityCreditTransfer1	</LqdyCdtTrf>
End message name LiquidityCreditTransfer	</LqdyCdtTrf>

Attributes:

name of attribute	format	short description	description
<LqdyCdtTrf>		Message name for LiquidityCreditTransfer Mandatory A2A	Message name for LiquidityCreditTransfer Validation: [1..1]
<MsgHdr>		Message Header Mandatory A2A	Set of characteristics specific to the message Validation: [1..1]
<MsgId>-</MsgId>	16x	Message Identification Mandatory A2A	String of characters that uniquely identifies a message Validation: [1..1]
</MsgHdr>		End of Message Header Mandatory A2A	Validation: [1..1]
<LqdyCdtTrf>		LiquidityCreditTransfer1 Mandatory A2A	LiquidityCreditTransfer Validation: [1..1]
<LqdyTrfld>		LiquidityTransferIdentification Mandatory A2A	Set of liquidity transfer references. Validation: [1..1]
<InstrId>-</InstrId>	16x	InstructionIdentification Mandatory A2A	Unique and unambiguous identifier for a payment instruction assigned by the initiating party Validation: [1..1]
<EndToEndId>-</EndToEndId>	16x	EndToEndIdentification Mandatory A2A	Unique and unambiguous identification of a payment transaction, as assigned by any of the parties on the initiating side, that will be passed on throughout the entire end-to-end chain Validation: [1..1]
</LqdyTrfld>		End of LiquidityTransferIdentification Mandatory A2A	Validation: [1..1]
<CdtrAcct>		CreditorAccount Mandatory A2A	Validation: [1..1]
<Id>		Identification Mandatory A2A	Identification Unique and unambiguous identification for the account between the account owner and the account servicer. Validation: [1..1]
<Othr>		GenericAccountIdentification	GenericAccountIdentification

name of attribute	format	short description	description
		n Mandatory A2A	Validation: [1..1]
<Id>-</Id>	34x	Identification Mandatory A2A	Name or number assigned by an entity to enable recognition of that entity, eg, account identifier. Validation: [1..1]
</Othr>		End of GenericAccountIdentification n Mandatory A2A	End of GenericAccountIdentification Validation: [1..1]
</Id>		End Identification Mandatory A2A	Validation: [1..1]
<Tp>		CashAccountType Mandatory A2A	CashAccountType Validation: [1..1]
<Cd>-</Cd>	4!c	CashAccountTypeCode Mandatory A2A	Supported codes: CASH = T2S Dedicated Cash Account SACC = TARGET2 RTGS Account Validation: [1..1]
</Tp>		End of CashAccountType Mandatory A2A	End of CashAccountType Validation: [1..1]
</CdtrAcct>		EndCreditorAccount Mandatory A2A	Validation: [1..1]
<TrfdAmt>		Transferred Amount Mandatory A2A	The amount may be defined with or without the currency. <AmtWthCcy> CurrencyAndAmount <AmtWthtCcy> ImpliedCurrencyAndAmount Validation: [1..1]
<AmtWthtCcy>-</AmtWthtCcy>	15d	AmountWithoutCurrency Mandatory A2A	Amount restriction similar to FIN format: max. total digits: 14 fraction digits: 2 but separator: "." Validation: [1..1]
</TrfdAmt>		End of Transferred Amount Mandatory A2A	Validation: [1..1]
<DbtrAcct>		DebtorAccount	

name of attribute	format	short description	description
		Mandatory A2A	Validation: [1..1]
<Id>		Identification	Identification Unique and unambiguous identification for the account between the account owner and the account servicer.
		Mandatory A2A	Validation: [1..1]
<Othr>		GenericAccountIdentification	GenericAccountIdentification
		Mandatory A2A	Validation: [1..1]
<Id>-</Id>	34x	Identification	Name or number assigned by an entity to enable recognition of that entity, eg, account identifier.
		Mandatory A2A	Validation: [1..1]
</Othr>		End of GenericAccountIdentification	End of GenericAccountIdentification
		Mandatory A2A	Validation: [1..1]
</Id>		End Identification	
		Mandatory A2A	Validation: [1..1]
<Tp>		CashAccountType	CashAccountType
		Mandatory A2A	Validation: [1..1]
<Cd>-</Cd>	4!c	CashAccountTypeCode	Supported codes: CASH = T2S Dedicated Cash Account SACC = TARGET2 RTGS Account
		Mandatory A2A	Validation: [1..1]
</Tp>		End of CashAccountType	End of CashAccountType
		Mandatory A2A	Validation: [1..1]
</DbtrAcct>		EndDebtorAccount	
		Mandatory A2A	Validation: [1..1]
<StlmDt>-</StlmDt>	ISODate	SettlementDate	Requested date for settlement. If not used the order will be processed when it arrives in PM.
		Optional A2A	Validation: [0..1]Must be the current TARGET2 business day.
</LqdyCdtTrf>		End of LiquidityCreditTransfer1	End of LiquidityCreditTransfer

name of attribute	format	short description	description
		Mandatory A2A	Validation: [1..1]
</LqdyCdtTrf>		End message name LiquidityCreditTransfer Mandatory A2A	End message name LiquidityCreditTransfer Validation: [1..1]

Error Codes:

Order	Error code				Error Text / Validation/ Remark
	SSP	Y-copy	V-shape	XML	
0	X00			0000	<p>Error Text: O.k.</p> <p>Validation: Confirmation of successful processing of the instruction. In case of "push" liquidity transfer to T2S, sent after credit booking on DCA has been notified by T2S. In case of "pull" liquidity transfer from T2S, sent after T2S accepted the forwarded instruction.</p> <p>Remark:</p>
0	T00			SPAS	<p>Error Text: Liquidity transfer partially settled.</p> <p>Validation: Confirmation of successful partial execution of "push" liquidity transfer to T2S in case of - instruction initiated by an actor registered as "T2S Actor in TARGET2", - sent during night-time settlement phase, - when available liquidity was not zero but less than the instructed amount and - all available liquidity has been moved to the indicated Dedicated Cash Account in T2S.</p> <p>Remark:</p>
1	X57			1417	<p>Error Text: Requestor DN not found in the DN matching table</p> <p>Validation: RequestorDN must be linked to a SSP participant. An active record in DN-BIC matching table is needed.</p> <p>Remark:</p>
2	X63			1423	<p>Error Text: No authorisation. Requestor is no PM participant.</p> <p>Validation: RequestorDN must be linked to a PM participant.</p> <p>Remark:</p>
3	X64			1424	<p>Error Text: No authorisation. Requestor has insufficient actor type.</p> <p>Validation: RequestorDN must be registered with one of the following actor types: "Participant - SWIFT-based", "T2S Actor in TARGET2", "Central Bank"</p> <p>Remark:</p>
4	X44			1404	<p>Error Text: If "non repudiation of emission" is mandatory, the NRE indicator flag has to be present</p> <p>Validation: Non repudiation of emission service is mandatory.</p> <p>Remark:</p>
5	X71			1431	<p>Error Text: This request type has to be sent in store-and-forward mode.</p> <p>Validation: Order message must be sent in store-and-forward mode.</p> <p>Remark:</p>
6	X42			1402	<p>Error Text: No authorisation. User is not allowed acting on behalf of another participant.</p> <p>Validation: If actor type is "Participant - SWIFT-based" and the requestor is no group of accounts manager, the RTGS account to be debited must belong to the working participant</p> <p>Remark:</p>
7	X45			1405	<p>Error Text: No authorisation or rather interaction not possible. User is not allowed acting on behalf of another participant as Group of Account manager</p> <p>Validation: If actor type is "Participant - SWIFT-based" and the requestor is a group of accounts manager, the RTGS account to be debited must belong to his group.</p> <p>Remark:</p>
8	X47			1407	<p>Error Text: No authorisation. User is not allowed acting on behalf of another</p>

Order	Error code				Error Text / Validation/ Remark
	SSP	Y-copy	V-shape	XML	
					Participant as Central Bank Validation: If actor type is "Central Bank" and working BIC is a CB's main BIC, the RTGS account to be debited must be held under the CB's responsibility. Remark:
9	X47			1407	Error Text: No authorisation. User is not allowed acting on behalf of another Participant as Central Bank Validation: If actor type is "Central Bank" and working BIC is the CB's main BIC, the DCA to be debited must be linked to a participant the CB is responsible for. Remark:
10	X42			1402	Error Text: No authorisation. User is not allowed acting on behalf of another participant. Validation: If actor type is "Central Bank" but working BIC is not the CB's main BIC, the RTGS account to be debited must match to the working participant. Remark:
11	X58			1406	Error Text: No authorisation. User is not allowed acting on behalf of another participant as T2S Actor in TARGET2. Validation: If actor type is "T2S Actor in TARGET2", the RTGS account to be debited must belong to the working participant. Remark:
12	X59			1419	Error Text: No authorisation. Requestor may not initiate this order type. Validation: If actor type is "T2S Actor in TARGET2", the debit account must not be a DCA. Remark:
13	T50	TU		T050	Error Text: Transfer not supported. LT can only be from RTGS account to DCA and vice versa. Validation: CreditAccountTypeCode must not be equal to DebitAccountTypeCode. Remark:
14	X62	TL		1422	Error Text: The DCA must be linked to a RTGS account related to the sender. Validation: If the requestor is working as participant and debit account is a DCA, it must be linked to the requestor's RTGS account. Remark:
15	X42			1402	Error Text: No authorisation. User is not allowed acting on behalf of another participant. Validation: If the requestor is working as participant asking to pull liquidity from T2S he must be the credit account holder. Remark:
16	X59			1419	Error Text: No authorisation. Requestor may not initiate this order type. Validation: If the requestor is working as group of accounts manager asking to pull liquidity from T2S the order will be rejected. Remark:
17	X47			1407	Error Text: No authorisation. User is not allowed acting on behalf of another Participant as Central Bank Validation: If the requestor is working as central bank asking to pull liquidity from T2S he must be responsible for the credit account holder. Remark:
18	P53			P053	Error Text: RTGS account does not exist or is not valid Validation: Indicated RTGS account has to be active Remark:

Order	Error code				Error Text / Validation/ Remark
	SSP	Y-copy	V-shape	XML	
19	T51	T1		T051	<p>Error Text: Invalid debit account type.</p> <p>Validation: RTGS account to be debited must have one of the following types: "Normal", "CB", "SF Interest", "RM Interest and Penalty" or "TARGET2 fees".</p> <p>Remark:</p>
20	T52	T2		T052	<p>Error Text: Invalid credit account type.</p> <p>Validation: RTGS account to be credited must have one of the following types: "Normal", "CB", "SF Interest", "RM Interest and Penalty" or "TARGET2 fees".</p> <p>Remark:</p>
21	T40			T040	<p>Error Text: Double Message Identification.</p> <p>Validation: The MessageIdentification has to be unique over all messages addressed to T2SI (independent of message types) for a period of 5 business days per RequestorDN.</p> <p>Remark:</p>
22	T41			T041	<p>Error Text: Double Instruction Identification.</p> <p>Validation: The InstructionIdentification must be unique per requestor BIC and current business day. The ID is only compared with those of valid messages forwarded to T2S.</p> <p>Remark:</p>
23	T42	C1		T042	<p>Error Text: Double End-to-End Identification.</p> <p>Validation: The EndToEndIdentification has to be unique per RTGS account. It is compared with those IDs used in LiquidityCreditTransfer messages (related to the same RTGS account) forwarded to T2S over the last 5 business days.</p> <p>Remark:</p>
24	P96	T3		P126	<p>Error Text: Date is not the current SSP business day</p> <p>Validation: Requested SettlementDate must be current SSP business day (if information is given)</p> <p>Remark:</p>
25	T10	TV		T010	<p>Error Text: T2S related value added service package required.</p> <p>Validation: If the DCA indicated in the message is to be debited (payment type = "Pull Liquidity from T2S"), the requestor must have opted for Value Added Services.</p> <p>Remark:</p>

LiquidityCreditTransfer_T2SI_1

Scope: Request for pushing liquidity to T2S (with business day check).

Message name for LiquidityCreditTransfer	<LqdyCdtTrf>
Message Header	<MsgHdr>
Message Identification	<MsgId>ABC123</MsgId>
End of Message Header	</MsgHdr>
LiquidityCreditTransfer1	<LqdyCdtTrf>
LiquidityTransferIdentification	<LqdyTrfId>
InstructionIdentification	<InstrId>ABCD1234</InstrId>
EndToEndIdentification	<EndToEndId>ABC12134</EndToEndId>
End of LiquidityTransferIdentification	</LqdyTrfId>
CreditorAccount	<CdtrAcct>
Identification	<Id>
GenericAccountIdentification	<Othr>
Identification	<Id>DE11DCA000012345</Id>
End of GenericAccountIdentification	</Othr>
End Identification	</Id>
CashAccountType	<Tp>
CashAccountTypeCode	<Cd>CASH</Cd>
End of CashAccountType	</Tp>
EndCreditorAccount	</CdtrAcct>
Transferred Amount	<TrfdAmt>
AmountWithoutCurrency	<AmtWthtCcy>1000000.95</AmtWthtCcy>
End of Transferred Amount	</TrfdAmt>
DebtorAccount	<DbtrAcct>
Identification	<Id>
GenericAccountIdentification	<Othr>
Identification	<Id>DE11RTGS0000123</Id>
End of GenericAccountIdentification	</Othr>
End Identification	</Id>
CashAccountType	<Tp>
CashAccountTypeCode	<Cd>SACC</Cd>
End of CashAccountType	</Tp>
EndDebtorAccount	</DbtrAcct>
SettlementDate	<SttlmDt>2014-11-11</SttlmDt>
End of LiquidityCreditTransfer1	</LqdyCdtTrf>
End message name LiquidityCreditTransfer	</LqdyCdtTrf>

LiquidityCreditTransfer_T2SI_2

Scope: Request for pulling liquidity from T2S (without business day check).

Message name for LiquidityCreditTransfer	<LqdyCdtTrf>
Message Header	<MsgHdr>
Message Identification	<MsgId>ABC123</MsgId>
End of Message Header	</MsgHdr>
LiquidityCreditTransfer1	<LqdyCdtTrf>
LiquidityTransferIdentification	<LqdyTrfId>
InstructionIdentification	<InstrId>ABCD1234</InstrId>
EndToEndIdentification	<EndToEndId>ABC12134</EndToEndId>
End of LiquidityTransferIdentification	</LqdyTrfId>
CreditorAccount	<CdtrAcct>
Identification	<Id>
GenericAccountIdentification	<Othr>
Identification	<Id>DE11RTGS0000123</Id>
End of GenericAccountIdentification	</Othr>
End Identification	</Id>
CashAccountType	<Tp>
CashAccountTypeCode	<Cd>SACC</Cd>
End of CashAccountType	</Tp>
EndCreditorAccount	</CdtrAcct>
Transferred Amount	<TrfdAmt>
AmountWithoutCurrency	<AmtWthtCcy>300000.95</AmtWthtCcy>
End of Transferred Amount	</TrfdAmt>
DebtorAccount	<DbtrAcct>
Identification	<Id>
GenericAccountIdentification	<Othr>
Identification	<Id>DE11DCA000012345</Id>
End of GenericAccountIdentification	</Othr>
End Identification	</Id>
CashAccountType	<Tp>
CashAccountTypeCode	<Cd>CASH</Cd>
End of CashAccountType	</Tp>
EndDebtorAccount	</DbtrAcct>
End of LiquidityCreditTransfer1	</LqdyCdtTrf>
End message name LiquidityCreditTransfer	</LqdyCdtTrf>

LiquidityCreditTransfer_T2SI_3

Scope: Outgoing message to account holder in case of liquidity transfer received from T2S (e.g. initiated by pull liquidity transfer from T2S).

Message name for LiquidityCreditTransfer	<LqdyCdtTrf>
Message Header	<MsgHdr>
Message Identification	<MsgId>ABC123</MsgId>
End of Message Header	</MsgHdr>
LiquidityCreditTransfer1	<LqdyCdtTrf>
LiquidityTransferIdentification	<LqdyTrfId>
InstructionIdentification	<InstrId>ABC12134</InstrId>
EndToEndIdentification	<EndToEndId>ABC12134</EndToEndId>
End of LiquidityTransferIdentification	</LqdyTrfId>
CreditorAccount	<CdtrAcct>
Identification	<Id>
GenericAccountIdentification	<Othr>
Identification	<Id>DE11RTGS0000123</Id>
End of GenericAccountIdentification	</Othr>
End Identification	</Id>
CashAccountType	<Tp>
CashAccountTypeCode	<Cd>SACC</Cd>
End of CashAccountType	</Tp>
EndCreditorAccount	</CdtrAcct>
Transferred Amount	<TrfdAmt>
AmountWithoutCurrency	<AmtWthtCcy>1000000.00</AmtWthtCcy>
End of Transferred Amount	</TrfdAmt>
DebtorAccount	<DbtrAcct>
Identification	<Id>
GenericAccountIdentification	<Othr>
Identification	<Id>DE11DCAS00001234</Id>
End of GenericAccountIdentification	</Othr>
End Identification	</Id>
CashAccountType	<Tp>
CashAccountTypeCode	<Cd>CASH</Cd>
End of CashAccountType	</Tp>
EndDebtorAccount	</DbtrAcct>
SettlementDate	<StlmDt>2014-11-11</StlmDt>
End of LiquidityCreditTransfer1	</LqdyCdtTrf>
End message name LiquidityCreditTransfer	</LqdyCdtTrf>

6.12. 6 LiquidityDebitTransfer (for CBs only)

Cash Management Standard

LiquidityDebitTransfer_T2SI

M

Scope: The LiquidityDebitTransfer will be pushed by T2SI in store-and-forward mode to a CB if TARGET2 receives such debit transfer from T2S.
This is expected at end of T2S business day to settle a negative balance in the CB's DCA.
There will be no additional debit notification.

Precondition for creation of this XML message is that the CB opted to receive such message type and no negative MT202.

The LiquidityDebitTransfer will be sent as "DARFT1camt.051.001.04".

Structure:

LiquidityDebitTransfer	<LqdyDbtTrf>
Message Header	<MsgHdr>
Message Identification	<MsgId></MsgId>
End of Message Header	</MsgHdr>
LiquidityDebitTransfer1	<LqdyDbtTrf>
LiquidityTransferIdentification	<LqdyTrfId>
InstructionIdentification	<InstrId></InstrId>
EndToEndIdentification	<EndToEndId></EndToEndId>
End of LiquidityTransferIdentification	</LqdyTrfId>
CreditorAccount	<CdtrAcct>
Identification	<Id>
GenericAccountIdentification	<Othr>
Identification	<Id></Id>
End of GenericAccountIdentification	</Othr>
End Identification	</Id>
EndCreditorAccount	</CdtrAcct>
Transferred Amount	<TrfdAmt>
AmountWithoutCurrency	<AmtWthtCcy></AmtWthtCcy>
End of Transferred Amount	</TrfdAmt>
DebtorAccount	<DbtrAcct>
Identification	<Id>
GenericAccountIdentification	<Othr>
Identification	<Id></Id>
End of GenericAccountIdentification	</Othr>
End Identification	</Id>
EndDebtorAccount	</DbtrAcct>
SettlementDate	<StlmDt></StlmDt>
End of LiquidityDebitTransfer1	</LqdyDbtTrf>
End of LiquidityDebitTransfer	</LqdyDbtTrf>

Attributes:

name of attribute	format	short description	description
<LqdyDbtTrf>		LiquidityDebitTransfer Mandatory A2A	Validation: [1..1]
<MsgHdr>		Message Header Mandatory A2A	Set of characteristics specific to the message Validation: [1..1]
<MsgId>-</MsgId>	16x	Message Identification Mandatory A2A	String of characters that uniquely identifies a message Validation: [1..1]
</MsgHdr>		End of Message Header Mandatory A2A	Validation: [1..1]
<LqdyDbtTrf>		LiquidityDebitTransfer1 Mandatory A2A	Validation: [1..1]
<LqdyTrfld>		LiquidityTransferIdentificatio n Mandatory A2A	Set of liquidity transfer references. Validation: [1..1]
<InstrId>-</InstrId>	16x	InstructionIdentification Mandatory A2A	Unique and unambiguous identifier for a payment instruction assigned by the initiating party Validation: [1..1]
<EndToEndId>-</EndToEndId>	16x	EndToEndIdentification Mandatory A2A	Unique and unambiguous identification of a payment transaction, as assigned by any of the parties on the initiating side, that will be passed on throughout the entire end-to-end chain Validation: [1..1]
</LqdyTrfld>		End of LiquidityTransferIdentificatio n Mandatory A2A	Validation: [1..1]
<CdtrAcct>		CreditorAccount Mandatory A2A	Validation: [1..1]
<Id>		Identification Mandatory A2A	Identification Unique and unambiguous identification for the account between the account owner and the account servicer. Validation: [1..1]
<Othr>		GenericAccountIdentificatio n	GenericAccountIdentification

name of attribute	format	short description	description
		Mandatory A2A	Validation: [1..1]
<Id>-</Id>	34x	Identification	Name or number assigned by an entity to enable recognition of that entity, eg, account identifier.
		Mandatory A2A	Validation: [1..1]
</Othr>		End of GenericAccountIdentificatio n	End of GenericAccountIdentification
		Mandatory A2A	Validation: [1..1]
</Id>		End Identification	
		Mandatory A2A	Validation: [1..1]
</CdtrAcct>		EndCreditorAccount	
		Mandatory A2A	Validation: [1..1]
<TrfdAmt>		Transferred Amount	The amount may be defined with or without the currency. <AmtWthCcy> CurrencyAndAmount <AmtWthtCcy> ImpliedCurrencyAndAmount
		Mandatory A2A	Validation: [1..1]
<AmtWthtCcy>-</AmtWthtCcy>	15d	AmountWithoutCurrency	Amount restriction similar to FIN format: max. total digits: 14 fraction digits: 2 but separator: "."
		Mandatory A2A	Validation: [1..1]
</TrfdAmt>		End of Transferred Amount	
		Mandatory A2A	Validation: [1..1]
<DbtrAcct>		DebtorAccount	
		Mandatory A2A	Validation: [1..1]
<Id>		Identification	Identification
			Unique and unambiguous identification for the account between the account owner and the account servicer.
		Mandatory A2A	Validation: [1..1]
<Othr>		GenericAccountIdentificatio n	GenericAccountIdentification
		Mandatory A2A	Validation: [1..1]
<Id>-</Id>	34x	Identification	Name or number assigned by an entity to enable recognition of that entity, eg, account identifier.
		Mandatory	Validation:

name of attribute	format	short description	description
		A2A	[1..1]
</Othr>		End of GenericAccountIdentificatio n	End of GenericAccountIdentification
		Mandatory	Validation: [1..1]
		A2A	[1..1]
</ld>		End Identification	
		Mandatory	Validation: [1..1]
		A2A	[1..1]
</DbtrAcct>		EndDebtorAccount	
		Mandatory	Validation: [1..1]
		A2A	[1..1]
<SttlmDt>-</SttlmDt>	ISODate	SettlementDate	Requested date for settlement.
			If not used the order will be processed when it arrives in PM.
		Mandatory	Validation: [1..1]Must be the current TARGET2 business day.
		A2A	[1..1]
</LqdyDbtTrf>		End of LiquidityDebitTransfer1	
		Mandatory	Validation: [1..1]
		A2A	[1..1]
</LqdyDbtTrf>		End of LiquidityDebitTransfer	
		Mandatory	Validation: [1..1]
		A2A	[1..1]

Error Codes:

LiquidityDebitTransfer_T2SI_1

Scope: LiquidityDebitTransfer pushed to a CB after debiting her RTGS account. (Initiated by inbound message from T2S.)

LiquidityDebitTransfer	<LqdyDbtTrf>
Message Header	<MsgHdr>
Message Identification	<MsgId>1234789</MsgId>
End of Message Header	</MsgHdr>
LiquidityDebitTransfer1	<LqdyDbtTrf>
LiquidityTransferIdentification	<LqdyTrfId>
InstructionIdentification	<InstrId>234567</InstrId>
EndToEndIdentification	<EndToEndId>T2S-1234</EndToEndId>
End of LiquidityTransferIdentification	</LqdyTrfId>
CreditorAccount	<CdtrAcct>
Identification	<Id>
GenericAccountIdentification	<Othr>
Identification	<Id>DE11DCA000012345</Id>
End of GenericAccountIdentification	</Othr>
End Identification	</Id>
EndCreditorAccount	</CdtrAcct>
Transferred Amount	<TrfdAmt>
AmountWithoutCurrency	<AmtWthtCcy>475000.15</AmtWthtCcy>
End of Transferred Amount	</TrfdAmt>
DebtorAccount	<DbtrAcct>
Identification	<Id>
GenericAccountIdentification	<Othr>
Identification	<Id>DE11RTGS0000123</Id>
End of GenericAccountIdentification	</Othr>
End Identification	</Id>
EndDebtorAccount	</DbtrAcct>
SettlementDate	<SttlmDt>2014-11-11</SttlmDt>
End of LiquidityDebitTransfer1	</LqdyDbtTrf>
End of LiquidityDebitTransfer	</LqdyDbtTrf>

6.12. 7 Receipt

Cash Management Standard

Receipt_T2SI

M

Scope: The Receipt message is sent by TARGET2 in store-and-forward mode in response to an order. It provides the final status of the order processing. Eg it is a settlement confirmation for LiquidityCreditTransfer or it provides a reject reason.

T2SI always uses "DRAFT1 camt.025.001.04" standard.

Structure:

message name receipt	<Rct>
Message Header	<MsgHdr>
Message Identification	<MsgId></MsgId>
End of Message Header	</MsgHdr>
Receipt details	<RctDtls>
original message ID	<OrgnMsgId>
Message Identification	<MsgId></MsgId>
End of Original Message ID	</OrgnMsgId>
RequestHandling	<ReqHdlg>
StatusCode	<StsCd></StsCd>
Description	<Desc></Desc>
End of Request Handling	</ReqHdlg>
End of Receipt details	</RctDtls>
End message name Receipt	</Rct>

Attributes:

name of attribute	format	short description	description
<Rct>		message name receipt Mandatory A2A	Validation: [1..1]
<MsgHdr>		Message Header Mandatory A2A	Set of characteristics specific to the message Validation: [1..1]
<MsgId></MsgId>	16x	Message Identification Mandatory A2A	String of characters that uniquely identifies a message Validation: [1..1]
</MsgHdr>		End of Message Header Mandatory A2A	Validation: [1..1]
<RctDtls>		Receipt details Mandatory A2A	may be multiple in case of deletion/modification of several standing order or current limits Validation: [1..1]
<OrgnMsgId>		original message ID Mandatory A2A	Additional Reference Reference to the task, generated by SSP module Validation: [1..1]
<MsgId></MsgId>	16x	Message Identification Mandatory A2A	String of characters that uniquely identifies a message T2SI always inserts the requestor's reference - MessageIdentification of the inbound order message. Validation: [1..1]
</OrgnMsgId>		End of Original Message ID Mandatory A2A	End of Original Message ID Validation: [1..1]
<ReqHdlg>		RequestHandling Mandatory A2A	Gives the status of the request. StatusCode Description Only one occurrence in case TARGET2 detects an error or returns status "0000" as confirmation of successful execution of the order. On the other hand side if the T2S detected an error TARGET2 uses error "T2SR" to indicate that the second occurrence provides the T2S error code. Validation: [1..2]
<StsCd></StsCd>	4!x	StatusCode	Specifies the status of the request. Specifies an alphanumeric string with a maximum length of 4 characters. XML Name: Max4AlphaNumericText XML Type: string Example: aBc9

name of attribute	format	short description	description
			Separate Specification see UDFS Error Codes In case of second occurrence please refer to T2S documentation to find the meaning of T2S error code.
		Mandatory A2A	Validation: [1..1]
<Desc>-</Desc>	140x	Description	Specification of the error, in free format. In case of liquidity transfers to T2S partially settled, this element provides information about the transferred amount.
		Optional A2A	Validation: [0..1]
</ReqHdlg>		End of Request Handling	End of Request Handling
		Mandatory A2A	Validation: [1..2]
</RctDtls>		End of Receipt details	
		Mandatory A2A	Validation: [1..1]
</Rct>		End message name Receipt	
		Mandatory A2A	Validation: [1..1]

Error Codes:

Receipt_T2SI_1

Scope: Receipt sent as settlement confirmation for LiquidityCreditTransfer.

message name receipt	<Rct>
Message Header	<MsgHdr>
Message Identification	<MsgId>123456</MsgId>
End of Message Header	</MsgHdr>
Receipt details	<RctDtls>
original message ID	<OrgnlMsgId>
Message Identification	<MsgId>ABC123</MsgId>
End of Original Message ID	</OrgnlMsgId>
RequestHandling	<ReqHdlg>
StatusCode	<StsCd>0000</StsCd>
Description	<Desc>O.k.</Desc>
End of Request Handling	</ReqHdlg>
End of Receipt details	</RctDtls>
End message name Receipt	</Rct>

Receipt_T2SI_2

Scope: Receipt sent as reject notification indicating an error detected by T2S.

message name receipt	<Rct>
Message Header	<MsgHdr>
Message Identification	<MsgId>123456</MsgId>
End of Message Header	</MsgHdr>
Receipt details	<RctDtIs>
original message ID	<OrgnlMsgId>
Message Identification	<MsgId>ABC123</MsgId>
End of Original Message ID	</OrgnlMsgId>
RequestHandling	<ReqHdlg>
StatusCode	<StsCd>T2SR</StsCd>
Description	<Desc>Rejected by T2S - Details provided by T2S error code</Desc>
End of Request Handling	</ReqHdlg>
RequestHandling	<ReqHdlg>
StatusCode	<StsCd>9999</StsCd>
End of Request Handling	</ReqHdlg>
End of Receipt details	</RctDtIs>
End message name Receipt	</Rct>

6.12. 8 ReturnAccount

Cash Management Standard

ReturnAccount_T2SI

M

Scope: This is the response to a GetAccount query sent by RTGS account holders, their group of account managers or CBs to get the balances of linked DCAs from T2S.
The requestor must have opted for T2S value added services to receive the wanted information.

The standard supported by T2SI is "DRAFT1camt.004.001.07".

Structure:

Message Type	<RtrAcct>
Message Header	<MsgHdr>
Message Identification	<MsgId></MsgId>
Original Business Query	<OrgnlBizQry>
Message Identification	<MsgId></MsgId>
End of Original Business Query	</OrgnlBizQry>
End of Message Header	</MsgHdr>
BusinessReportOrErrorChoice	<RptOrErr>
Choice	xorAcctRptOprlErr
AccountReport	<AcctRpt>
Account Identification	<AcctId>
GenericAccountIdentification	<Othr>
Identification	<Id></Id>
End of GenericAccountIdentification	</Othr>
End of Account Identification	</AcctId>
Account information (or business error)	<AcctOrErr>
Account Identification	<Acct>
Currency	<Ccy><Ccy>
Owner	<Ownr>
Name	<Nm></Nm>
Identification	<Id>
OrganisationIdentification	<OrgId>
AnyBICIdentifier	<AnyBIC></AnyBIC>
End of OrganisationIdentification	</OrgId>
End Identification	</Id>
End of Owner	</Ownr>
Servicer	<Svcr>
Financial Institution Identification	<FinInstnId>
BICFIIdentifier	<BICFI></BICFI>
End of Financial Institution Identification	</FinInstnId>
End of Servicer	</Svcr>
MultilateralBalance	<MulBal>
Amount	<Amt></Amt>
Credit or debit indicator	<CdtDbtInd></CdtDbtInd>
BalanceTypeCode	<Tp>
Proprietary	<Prtry></Prtry>
End of BalanceTypeCode	</Tp>
Value Date	<ValDt>
Date Time	<DtTm></DtTm>
End of Value Date / Time	</ValDt>
RestrictionType	<RstrctnTp>
Type of the restriction	<Tp>
RestrictionTypeeld	<Id></Id>

End of Type of the restriction	</Tp>
Processing Type	<PrcgTp>
RestrictionTypeCode	<Cd></Cd>
End of Processing type	</PrcgTp>
End of RestrictionType	</RstrctnTp>
End of MultilateralBalance	</MulBal>
End of Account	</Acct>
End of Account or Business Error	</AcctOrErr>
End of AccountReport	</AcctRpt>
OperationalError	<OpriErr>
Error handling	<Err>
Proprietary error code	<Prtry></Prtry>
End error handling	</Err>
Description	<Desc></Desc>
End of Operational Error	</OpriErr>
End of Choice	/xorAcctRptOpriErr
End of BusinessDayReportOrErrorChoice	</RptOrErr>
End of Message Type	</RtrAcct>

Attributes:

name of attribute	format	short description	description
<RtrAcct>		Message Type Mandatory	Validation: [1..1]
<MsgHdr>		Message Header Mandatory	Set of characteristics specific to the message Validation: [1..1]
<MsgId>-</MsgId>	16x	Message Identification Mandatory	String of characters that uniquely identifies a message Validation: [1..1]
<OrgnlBizQry>		Original Business Query Mandatory	Original Business Query, reference to the query Validation: [1..1]
<MsgId>-</MsgId>	16x	Message Identification Mandatory	String of characters that uniquely identifies a message Validation: [1..1]
</OrgnlBizQry>		End of Original Business Query Mandatory	End of Original Business Query, reference to the query Validation: [1..1]
</MsgHdr>		End of Message Header Mandatory	Validation: [1..1]
<RptOrErr>		BusinessReportOrErrorChoice Mandatory	Validation: [1..1]
xorAcctRptOprlErr		Choice Optional	Choice between AccountReport and OperationalError Validation:
<AcctRpt>		AccountReport Mandatory	Included information is forwarded as received from T2S. Validation: [1..1]
<AcctId>		Account Identification Mandatory	Account Identification Validation: [1..1]
<Othr>		GenericAccountIdentification Mandatory	GenericAccountIdentification Validation: [1..1]
<Id>-</Id>	34x	Identification Mandatory	Name or number assigned by an entity to enable recognition of that entity, eg, account identifier. Identification of DCA. Validation: [1..1]

name of attribute	format	short description	description
</Othr>		End of GenericAccountIdentification Mandatory	End of GenericAccountIdentification Validation: [1..1]
</AcctId>		End of Account Identification Mandatory	Unique and unambiguous identification for the account between the account owner and the account servicer. Validation: [1..1]
<AcctOrErr>		Account information (or business error) Mandatory	Validation: [1..1]
<Acct>		Account Identification Mandatory	Validation: [1..1]
<Ccy>-<Ccy>	3!a	Currency Optional	Fixed value "EUR". Validation: [0..1]
<Ownr>		Owner Optional	Validation: [0..1]
<Nm>-</Nm>	140x	Name Optional	Validation: [0..1]
<Id>		Identification Optional	Identification Validation: [0..1]
<OrgId>		OrganisationIdentification Mandatory	OrganisationIdentification Validation: [1..1]
<AnyBIC>-</AnyBIC>	4!a2!a2!c[3!cAnyBICIdentifier]	Mandatory	BIC of the account holder. Validation: [1..1]
</OrgId>		End of OrganisationIdentification Mandatory	End of OrganisationIdentification Validation: [1..1]
</Id>		End Identification Optional	Validation: [0..1]
</Ownr>		End of Owner Optional	Validation: [0..1]
<Svcr>		Servicer	

name of attribute	format	short description	description
		Optional	Validation: [0..1]
<FinInstnId>		Financial Institution Identification Mandatory	Financial Institution Identification Validation: [1..1]
<BICFI>-</BICFI>	4!a2!a2!c3!c	BICFIIdentifier Mandatory	BICFIIdentifier Validation: [1..1]
</FinInstnId>		End of Financial Institution Identification Mandatory	End of Financial Institution Identification Validation: [1..1]
</Svcr>		End of Servicer Optional	Validation: [0..1]
<MulBal>		MultilateralBalance Optional	Balance is calculated with regard to many members in the system. Validation: [0..n]
<Amt>-</Amt>	15d	Amount Mandatory	Amount (with implied currency) Validation: [1..1]
<CdtDbtInd>-</CdtDbtInd>	4!a	Credit or debit indicator Mandatory	Validation: [1..1]
<Tp>		BalanceTypeCode Mandatory	Validation: [1..1]
<Prtry>-</Prtry>	4!a	Proprietary Mandatory	Proprietary T2S BalanceTypeCode Possible values: - "ACCA" = Available balance per DCA - "RSTR" - Restriction type field used - "SBCB" = Sum of blocked balances per DCA - "SRCB" = Sum of reserved balances per DCA - "TCCA" = Current balance (= sum of the three before mentioned balances) Validation: [1..1]
</Tp>		End of BalanceTypeCode Mandatory	Specifies the nature of the balance Validation: [1..1]
<ValDt>		Value Date Optional	Validation: [0..1]
<DtTm>-</DtTm>	ISODateTime	Date Time	

name of attribute	format	short description	description
		Mandatory	Validation: [1..1]
</ValDt>		End of Value Date / Time	
		Optional	Validation: [0..1]
<RstrctnTp>		RestrictionType	RestrictionType
			Optional element used in case of BalanceTypeCode = "RSTR".
		Optional	Validation: [0..1]
<Tp>		Type of the restriction	Type of the restriction
		Mandatory	Validation:
<Id></Id>	4!c	RestrictionTypeId	RestrictionTypeId
			Identification assigned by an institution.
		Mandatory	Validation: [1..1]
</Tp>		End of Type of the restriction	End of Type of the restriction
		Mandatory	Validation:
<PrcgTp>		Processing Type	Type providing further information on balance restriction
		Optional	Validation:
<Cd></Cd>	4!c	RestrictionTypeCode	RestrictionTypeCode
			T2S restriction type codes for Dedicated Cash Account Balance Query. - Possible values are: "BLCK" - Blocking "CSDB" - CoSDBlocking "EARM" - Earmarking "EFAC" - EarmarkingForAutoCollateralisation "RSVT" - Reservation
		Mandatory	Validation: [0..1]
</PrcgTp>		End of Processing type	End of type providing further information on balance restriction
		Optional	Validation:
</RstrctnTp>		End of RestrictionType	End of RestrictionType
			Optional element used in case of BalanceTypeCode = "RSTR".
		Optional	Validation: [0..1]
</MulBal>		End of MultilateralBalance	End of MultilateralBalance
		Optional	Validation: [0..n]

name of attribute	format	short description	description
</Acct>		End of Account Mandatory	End of Account Validation: [1..1]
</AcctOrErr>		End of Account or Business Error Mandatory	Validation: [1..1]
</AcctRpt>		End of AccountReport Mandatory	Validation: [1..n]
<OpriErr>		OperationalError Mandatory	Rule rationale: The message will contain either the information matching the search criteria of the related Get message or an error indication. Rule description: If BusinessReport is present then OperationalError is not allowed. If BusinessReport is not present, then OperationalError is mandatory. Separate Specification see UDFS books regarding error codes Only one occurrence if TARGET2 detects an error, but used twice if T2S reports an error. In the latter case first error code is the one of TARGET2 ("T2SR") indicating that the following one is from T2S. Validation: [1..2]
<Err>		Error handling Mandatory	Validation: [1..1]
<Prtry>-</Prtry>	4x	Proprietary error code Mandatory	Specification of the error, in free format. Validation: [1..1]
</Err>		End error handling Mandatory	Validation: [1..1]
<Desc>-</Desc>	140x	Description Optional	Specification of the error, in free format. Validation: [0..1]
</OpriErr>		End of Operational Error Mandatory	End of Operational Error Validation: [1..2]
/xorAcctRptOpriErr		End of Choice Optional	Validation:
</RptOrErr>		End of BusinessDayReportOrError Choice Mandatory	Validation: [1..1]
</RtrAcct>		End of Message Type	

name of attribute	format	short description	description
		Mandatory	Validation: [1..1]

Error Codes:

ReturnAccount_T2SI_1

Scope: ReturnAccount providing balance information from T2S.

Message Type	<RtrAcct>
Message Header	<MsgHdr>
Message Identification	<MsgId>23456</MsgId>
Original Business Query	<OrgnlBizQry>
Message Identification	<MsgId>ABC123</MsgId>
End of Original Business Query	</OrgnlBizQry>
End of Message Header	</MsgHdr>
BusinessReportOrErrorChoice	<RptOrErr>
AccountReport	<AcctRpt>
Account Identification	<AcctId>
GenericAccountIdentification	<Othr>
Identification	<Id>T2SDEDICATEDCASHACCOUNT1</Id>
End of GenericAccountIdentification	</Othr>
End of Account Identification	</AcctId>
Account information (or business error)	<AcctOrErr>
Account Identification	<Acct>
Currency	<Ccy>EUR</Ccy>
Owner	<Ownc>
Identification	<Id>
OrganisationIdentification	<OrgId>
AnyBICIdentifier	<AnyBIC>ACCTOWNRXXX</AnyBIC>
End of OrganisationIdentification	</OrgId>
End Identification	</Id>
End of Owner	</Ownc>
Servicer	<Svcr>
Financial Institution Identification	<FinInstnId>
BICFIIdentifier	<BICFI>ACCTSVCRXXX</BICFI>
End of Financial Institution Identification	</FinInstnId>
End of Servicer	</Svcr>
MultilateralBalance	<MulBal>
Amount	<Amt>5000000.00</Amt>
Credit or debit indicator	<CdtDbtInd>CRDT</CdtDbtInd>
BalanceTypeCode	<Tp>
Proprietary	<Prtry>ACCA</Prtry>
End of BalanceTypeCode	</Tp>
Value Date	<ValDt>
Date Time	<DtTm>2014-12-17T09:30:47</DtTm>
End of Value Date / Time	</ValDt>
End of MultilateralBalance	</MulBal>
End of Account	</Acct>
End of Account or Business Error	</AcctOrErr>
End of AccountReport	</AcctRpt>
End of BusinessDayReportOrErrorChoice	</RptOrErr>
End of Message Type	</RtrAcct>

ReturnAccount_T2SI_2

Scope: ReturnAccount providing reject reason from T2S.

Message Type	<RtrAcct>
Message Header	<MsgHdr>
Message Identification	<MsgId>23456</MsgId>
Original Business Query	<OrgnlBizQry>
Message Identification	<MsgId>ABC123</MsgId>
End of Original Business Query	</OrgnlBizQry>
End of Message Header	</MsgHdr>
BusinessReportOrErrorChoice	<RptOrErr>
OperationalError	<OprlErr>
Error handling	<Err>
Proprietary error code	<Prtry>T2SR</Prtry>
End error handling	</Err>
Description	<Desc>Rejected by T2S - Details provided by T2S error code</Desc>
End of Operational Error	</OprlErr>
OperationalError	<OprlErr>
Error handling	<Err>
Proprietary error code	<Prtry>L007</Prtry>
End error handling	</Err>
End of Operational Error	</OprlErr>
End of BusinessDayReportOrErrorChoice	</RptOrErr>
End of Message Type	</RtrAcct>

6.12. 9 ReturnTransaction

Cash Management Standard

ReturnTransaction_T2SI

M

Scope: Response message to GetTransaction_T2SI query.
 The message is very similar to ReturnTransaction_PM but all available information will be reported - no possibility to control return criteria by the request.
 As delta set retrieval is not supported element <QryNm> is not available.

The standard used by T2SI is "DRAFT1camt.006.001.07".

Structure:

Messagename for Return Transaction	<RtrTx>
Message Header	<MsgHdr>
Message Identification	<MsgId></MsgId>
Original Business Query	<OrgnBizQry>
Message Identification	<MsgId></MsgId>
End of Original Business Query	</OrgnBizQry>
End of Message Header	</MsgHdr>
BusinessReportOrErrorChoice	<RptOrErr>
Choice	xorBizRptOprlErr
BusinessReport	<BizRpt>
TransactionReport	<TxRpt>
PaymentIdentification	<PmtId>
ProprietaryId	<PrtryId></PrtryId>
EndPaymentIdentification	</PmtId>
TransactionOrErrorChoice	<TxOrErr>
Transaction	<Tx>
Payment To	<PmtTo>
Member Identification	<Mmbld>
Financial Institution Identification	<FinInstnId>
BICFIIdentifier	<BICFI></BICFI>
End of Financial Institution Identification	</FinInstnId>
End Member Identification	</Mmbld>
End PaymentTo	</PmtTo>
PaymentFrom	<PmtFr>
Member Identification	<Mmbld>
Financial Institution Identification	<FinInstnId>
BICFIIdentifier	<BICFI></BICFI>
End of Financial Institution Identification	</FinInstnId>
End Member Identification	</Mmbld>
End Payment From	</PmtFr>
Credit Debit Indicator	<CdtDbtInd></CdtDbtInd>
Payment	<Pmt>
Message Identification	<MsgId></MsgId>
PaymentStatus	<Sts>
PaymentStatusCode	<Cd>
Choice	xorPdgFnl
Pending	<Pdg></Pdg>
Final	<Fnl></Fnl>
End of Choice	/xorPdgFnl
End of PaymentStatusCode	</Cd>
DateTime	<DtTm>
Date Time	<DtTm></DtTm>

End of IntermediaryAgent	</IntrmyAgt>
CreditorAgent	<CdtrAgt>
Financial Institution Identification	<FinInstnId>
BICFIIdentifier	<BICFI></BICFI>
End of Financial Institution Identification	</FinInstnId>
End of CreditorAgent	</CdtrAgt>
Creditor	<Cdtr>
Financial Institution Identification	<FinInstnId>
BICFIIdentifier	<BICFI></BICFI>
End of Financial Institution Identification	</FinInstnId>
End of Creditor	</Cdtr>
End of Parties	</Pties>
End of Payment	</Pmt>
AccountEntry	<AcctNtry>
Account Identification	<Acct>
Identification	<Id>
GenericAccountIdentification	<Othr>
Identification	<Id></Id>
End of GenericAccountIdentification	</Othr>
End Identification	</Id>
End of Account	</Acct>
Information account statement report.	<Ntry>
Date	<Dt>
Date Time	<DtTm></DtTm>
End of Date	</Dt>
End of Information account statement report	</Ntry>
End of Account Entry	</AcctNtry>
End Transaction	</Tx>
End of TransactionOrErrorChoice	</TxOrErr>
End Transaction Report	</TxRpt>
End of BusinessReport	</BizRpt>
OperationalError	<OprlErr>
Error handling	<Err>
Proprietary error code	<Prtry></Prtry>
End error handling	</Err>
Description	<Desc></Desc>
End of Operational Error	</OprlErr>
End of choice	/xorBizRptOprlErr
End of BusinessReportOrErrorChoice	</RptOrErr>
End message ReturnTransaction	</RtrTx>

Attributes:

name of attribute	format	short description	description
<RtrTx>		Message name for Return Transaction Mandatory A2A	Message name for Return Transaction Validation:
<MsgHdr>		Message Header Mandatory A2A	Set of characteristics specific to the message Validation: [1..1]
<MsgId>-</MsgId>	35x	Message Identification Mandatory A2A	Message Identification Validation: [1..1]
<OrgnBizQry>		Original Business Query Mandatory A2A	Original Business Query, reference to the query Validation: [1..1]
<MsgId>-</MsgId>	35x	Message Identification Mandatory A2A	Message Identification Validation: [1..1]
</OrgnBizQry>		End of Original Business Query Mandatory A2A	End of Original Business Query, reference to the query Validation: [1..1]
</MsgHdr>		End of Message Header Mandatory A2A	Validation: [1..1]
<RptOrErr>		BusinessReportOrErrorChoice Mandatory	Validation: [1..1]
xorBizRptOprlErr		Choice Mandatory	Validation: choice amongst BusinessReport <BizRpt> OperationalError <OprlErr>
<BizRpt>		BusinessReport Mandatory A2A	BusinessReport Validation: [1..1]
<TxRpt>		TransactionReport Mandatory A2A	Validation: [1..n]
<PmtId>		PaymentIdentification Mandatory A2A	Set of elements to provide further means of referencing a payment transaction Validation: [1..1]
<PrtryId>-</PrtryId>	16n	ProprietaryId	ProprietaryId SSP Booking ID (generated by PM [16n]; unique and

name of attribute	format	short description	description
		Mandatory A2A	unambiguous identifier of a booking) Validation: [1..1]
</PmtId>		EndPaymentIdentification Mandatory A2A	End of Set of elements to reference a payment transaction Validation: [1..1]
<TxOrErr>		TransactionOrErrorChoice Mandatory	Validation: [1..1]
<Tx>		Transaction Mandatory A2A	Validation: [1..1] BusinessError is not used
<PmtTo>		Payment To Mandatory A2A	Validation: [1..1]
<Mmbld>		Member Identification Mandatory A2A	Unique and unambiguous identification of a member within a system, assigned using the member identification scheme of the system Validation: [1..1]
<FinInstnId>		Financial Institution Identification Mandatory	Financial Institution Identification Validation: [1..1]
<BICFI>-</BICFI>	4!a2!a2!c3!c	BICFIIdentifier Mandatory A2A	BICFIIdentifier - BIC of the Receiver (normally the technical BIC of PM: TRGTXEPM2S) Validation: [1..1]
</FinInstnId>		End of Financial Institution Identification Mandatory	End of Financial Institution Identification Validation: [1..1]
</Mmbld>		End Member Identification Mandatory A2A	Validation: [1..1]
</PmtTo>		End PaymentTo Mandatory A2A	End PaymentTo Validation: [1..1]
<PmtFr>		PaymentFrom Mandatory A2A	Validation: [1..1]
<Mmbld>		Member Identification	Unique and unambiguous identification of a member within a system, assigned using the member identification scheme of the system

name of attribute	format	short description	description
		Mandatory	Validation:
		A2A	[1..1]
<FinInstnId>		Financial Institution Identification	Financial Institution Identification
		Mandatory	Validation:
			[1..1]
<BICFI>-</BICFI>	4!a2!a2!c3!c	BICFIIdentifier	BICFIIdentifier - BIC of the Sender
		Mandatory	Validation:
		A2A	[1..1]
</FinInstnId>		End of Financial Institution Identification	End of Financial Institution Identification
		Mandatory	Validation:
			[1..1]
</Mmbld>		End Member Identification	
		Mandatory	Validation:
		A2A	[1..1]
</PmtFr>		End Payment From	
		Mandatory	Validation:
		A2A	[1..1]
<CdtDbtInd>		Credit Debit Indicator	Credit Debit Indicator
			Indicates whether a Credit Debit Code is requested. Settlement Debits / Credits
		Optional	Validation:
		A2A	[0..1]
<Pmt>		Payment	Information about the payment and, possibly, its related charges.
		Optional	Validation:
		A2A	[0..1]
<MsgId>-</MsgId>	16x	Message Identification	String of characters that uniquely identifies a message The business case reference enables the customer to link all booking entries stemming from one business case (eg relevant for reverse bookings).
		Optional	Validation:
		A2A	[0..1]
<Sts>		PaymentStatus	
		Optional	Validation:
		A2A	[0..1]
<Cd>		PaymentStatusCode	
		Optional	Validation:
		A2A	[0..1]
xorPdgFnl		Choice	Choice between Pending and Final status choice amongst <Pdg>, <Fnl>
		Mandatory	Validation:
<Pdg>-</Pdg>	4!c	Pending	Pending Status Code of the payment STLE= earmarked

name of attribute	format	short description	description
			PSTL = pending STLM = information period ACPD = warehoused
		Mandatory	For liquidity transfers to T2S only STLE and PSTL are relevant: STLE used in case the agreement of CB is needed due to exclusion of participant. PSTL applies to queued transfers.
		A2A	Validation: [1..1]
<Fnl>-</Fnl>	4!c	Final	Final Status Code of the payment in PM only CAND = Revoked, STLD = by means of final, RJTD = Rejected are used
		Mandatory	
		A2A	Validation: [1..1]
/xorPdgFnl		End of Choice	
		Mandatory	Validation:
</Cd>		End of PaymentStatusCode	
		Optional	Validation:
		A2A	[0..1]
<DtTm>		DateTime	A specified date and time.
		Optional	Validation:
		A2A	[0..1] Only available for settled transactions
<DtTm>-</DtTm>	ISODateTime	Date Time	PM settlement time
		Mandatory	Validation:
		A2A	[1..1]
</DtTm>		End of DateTime	
		Optional	Validation:
		A2A	[0..1]
<Rsn>		Reason	
		Optional	Validation:
		A2A	[0..1]only ProprietaryStatusJustification used in PM
<PrtryRjctn>		ProprietaryStatusJustification	
		Mandatory	Validation:
		A2A	[1..1]
<PrtryStsRsn>-</PrtryStsRsn>	4x	Proprietary Status Reason	SSP Error Code mentioned in case of rejected or revoked payments or in case of reverse bookings.
		Mandatory	Validation:
		A2A	[1..1]
<Rsn>-</Rsn>	256x	Reason	Reason Error text.
		Mandatory	Validation:
		A2A	[1..1]
</PrtryRjctn>		End of ProprietaryStatusJustification	

name of attribute	format	short description	description
		n	
		Mandatory	Validation:
		A2A	[1..1]
</Rsn>		End of Reason	
		Optional	Validation:
		A2A	[0..1]
</Sts>		End of SystemStatus	
		Optional	Validation:
		A2A	[0..1]
<InstdAmt>		InstructedAmount	Specifies the instructed amount(s) on which the query is performed.
			Amount
		Optional	Validation:
		A2A	[0..1] In PM only 2 fraction digits are allowed
<AmtWthtCcy>-</AmtWthtCcy>	18n	Amount without currency	
		Mandatory	Validation:
		A2A	[1..1] In PM only 2 fraction digits are possible
</InstdAmt>		End Instructed Amount	
		Optional	Validation:
		A2A	[0..1]
<PmtMtd>		PaymentMethod	PaymentMethod
		Optional	Validation:
		A2A	[0..1] PM only uses <FINMT> and <Prtry>.
xorFINMTPrtry		Choice	Choice amongst <FINMT> and <Prtry>
		Mandatory	Validation:
<FINMT>-</FINMT>	3x	FINMessageType	possible values: 103 202 204
			FINMT Message Type. Possible values are: 202 (MT202 and MT202COV), 103 (MT103 and MT103+) or 204 (MT204).
			Not relevant here because the requestor cannot initiate payment via FIN messages.
		Mandatory	Validation:
		A2A	[1..1]
<Prtry>-</Prtry>	6c	ProprietaryPaymentOriginType	ASXML = Bookings stemming from incoming AS XML payments T2SXML = Bookings stemming from incoming T2S XML payments T2SXML = Bookings stemming from incoming TIPS XML payments INTERN = Bookings stemming from internal messages ORDER = Bookings stemming from current orders sent via ICM
			Values supported by PM: ASXML, INTERN, ORDER and T2SXML.
			Here only T2SXML is relevant because other messages may not be sent by the requestor.
		Mandatory	Validation:
			[1..1]

name of attribute	format	short description	description
/xorFINMTPrtry		End of Choice Mandatory	Validation:
</PmtMtd>		End of Payment Method Mandatory A2A	Validation: [1..1]
<Prty>		Priority Mandatory A2A	Priority The relative urgency or order of importance that the originator would like the recipient of the payment instruction to apply to the processing of the payment instruction. Code [1..1] Priority1Code PriorityCodeChoice PaymentInstruction (Priority) ProprietaryCode [1..1] Max4AlphaNumericText Validation: [1..1]
<Cd>-</Cd>		Priority Code Mandatory A2A	Specifies the priority level of an event. HIGH = High Priority level is high. LOWW = Low Priority level is low. NORM = Normal Priority level is normal. Liquidity transfers to T2S have always highly urgent priority: HIGH Validation: [1..1]
</Prty>		End Priority Mandatory A2A	Validation: [1..1]
<PrcgVldtyTm>		ProcessingValidityTime Optional A2A	Timed payments: Payments with Earliest and/or Latest Debit Time Not relevant in this reponse because not supported in LiquidityCreditTransfer messages. Validation: [0..1]
xorFrDtTmToDtTmDtTmRg		choice Mandatory	choice amongst <FrDtTm>, <ToDtTm> or <DtTmRg> Validation:
<FrDtTm>-</FrDtTm>	ISODateTime	FromDateTime Mandatory A2A	Date and time at which the range starts. Validation: [1..1]
<ToDtTm>-</ToDtTm>	ISODateTime	ToDateTime Mandatory A2A	Date and time at which the range ends. Validation: [1..1]
<DtTmRg>		DateTimeRange	

name of attribute	format	short description	description
		Mandatory A2A	Validation: [1..1]
<FrDtTm>-</FrDtTm>	ISODateTime	FromDateTime Mandatory A2A	Date and time at which the range starts. Validation: [1..1]
<ToDtTm>-</ToDtTm>	ISODateTime	ToDateTime Mandatory A2A	Date and time at which the range ends. Validation: [1..1]
</DtTmRg>		End Date Time Range Mandatory A2A	Validation: [1..1]
/xorFrDtTmToDtTmDtTmRg		End of choice Mandatory	end of choice amongst <FrDtTm>, or <ToDtTm> or <DtTmRg> Validation:
</PrcgVldtyTm>		End Processing Validity Time Optional A2A	Validation: [0..1]
<InstrCpy>-</InstrCpy>	10000x	InstructionCopy Optional A2A	Copy of the original instruction, in free form text. Content of business payload (application header + document) will be provided within a CDATA section. Validation: [0..1]
<Tp>		Type Optional A2A	Payment Type Validation: [0..1]
<PrtryPmtTp>-</PrtryPmtTp>	4x	Proprietary Payment Type Mandatory A2A	Proprietary Payment Type REGP = Regular Payment CONP = Connected Payment BACP = Backup Payment LIQP = Liquidity transfer via payments ASYP = Ancillary Systems Payments MANP= mandated payment INTP = interests PDDB = penalties BIDB = billing T2SL = T2S transactions Only "LIQP" is relevant for the requestor of this message. Validation: [1..1]
</Tp>		End of Type Optional A2A	End of Payment Type Validation: [0..1]
<Txld>-</Txld>	16x	TransactionIdentification 16x	Unique and unambiguous identification of a payment transaction, as assigned by the originator. The payment transaction reference is used for reconciliation or to link tasks relating to the payment transaction. InstructionIdentification from LiquidityCreditTransfer

name of attribute	format	short description	description
		Optional A2A	Validation: [0..1]
<IntrBkSttlmDt>- </IntrBkSttlmDt>	ISODate	Value date Optional A2A	Value date Execution Date current and future (5 future dates are possible) / Value Date Validation: [0..1]
<EndToEndId>- </EndToEndId>	16x	EndToEndIdentification Optional A2A	Unique and unambiguous identification of a payment transaction, as assigned by any of the parties on the initiating side, that will be passed on throughout the entire end-to-end chain EndToEndIdentification from LiquidityCreditTransfer message. Validation: [0..1]
<Pties>		Parties Optional A2A	PaymentTransactionParties needed for selection of Selection SWIFT FIN Fields Not relevant. LiquidityCreditTransfer message does not support indication of different parties. Validation: [0..1]
<DbtrAgt>		Debtor Agent Optional A2A	Debtor Agent in SSP only <Mmbld> with BICFI possible F52, ordering institution in case of FIN payment Validation: [0..1]
<FinInstnId>		Financial Institution Identification Mandatory	Financial Institution Identification Validation: [1..1]
<BICFI>-</BICFI>	4!a2!a2!c3!c	BICFIIdentifier Mandatory	BICFIIdentifier Validation: [1..1]
</FinInstnId>		End of Financial Institution Identification Mandatory	End of Financial Institution Identification Validation: [1..1]
</DbtrAgt>		End of DebtorAgent Optional	Validation: [0..1]
<InstdRmbrsmntAgt>		InstructedReimbursementAgent Optional A2A	Receivers Correspondent F54, receivers correspondent in case of FIN payment Validation: [0..1]
<FinInstnId>		Financial Institution Identification Mandatory	Financial Institution Identification Validation: [1..1]
<BICFI>-</BICFI>	4!a2!a2!c3!c	BICFIIdentifier	BICFIIdentifier

name of attribute	format	short description	description
		Mandatory	Validation: [1..1]
</FinInstnId>		End of Financial Institution Identification Mandatory	End of Financial Institution Identification Validation: [1..1]
</InstdRmbrsmntAgt>		End of InstructedReimbursementAgent Optional	Validation: [0..1]
<IntrmyAgt>		IntermediaryAgent Optional A2A	Intermediary party in the settlement chain, eg, a party from which the Sender received the cash, when other than the originator. F56, intermediary institution in case of FIN payment Validation: [0..1]
<FinInstnId>		Financial Institution Identification Mandatory	Financial Institution Identification Validation: [1..1]
<BICFI>-</BICFI>	4!a2!a2!c3!c	BICFIIdentifier Mandatory	BICFIIdentifier Validation: [1..1]
</FinInstnId>		End of Financial Institution Identification Mandatory	End of Financial Institution Identification Validation: [1..1]
</IntrmyAgt>		End of IntermediaryAgent Optional	Validation: [0..1]
<CdtrAgt>		CreditorAgent Optional A2A	Final Agent F57, account with institution in case of FIN payment Validation: [0..1]
<FinInstnId>		Financial Institution Identification Mandatory	Financial Institution Identification Validation: [1..1]
<BICFI>-</BICFI>	4!a2!a2!c3!c	BICFIIdentifier Mandatory	BICFIIdentifier Validation: [1..1]
</FinInstnId>		End of Financial Institution Identification Mandatory	End of Financial Institution Identification Validation: [1..1]
</CdtrAgt>		End of CreditorAgent Optional	Validation: [0..1]

name of attribute	format	short description	description
<Cdtr>		Creditor	F58, beneficiary institution in case of FIN payment
		Optional	Validation:
		A2A	[0..1]
<FinInstnId>		Financial Institution Identification	Financial Institution Identification
		Mandatory	Validation:
			[1..1]
<BICFI>-</BICFI>	4!a2!a2!c3!c	BICFIIdentifier	BICFIIdentifier
		Mandatory	Validation:
			[1..1]
</FinInstnId>		End of Financial Institution Identification	End of Financial Institution Identification
		Mandatory	Validation:
			[1..1]
</Cdtr>		End of Creditor	
		Optional	Validation:
			[0..1]
</Pties>		End of Parties	End Selection SWIFT FIN Fields
		Optional	Validation:
		A2A	[0..1]
</Pmt>		End of Payment	End of Payment
		Optional	Validation:
		A2A	[0..1]
<AcctNtry>		AccountEntry	Posting of an item to a cash account, in the context of a cash transaction, that results in an increase or decrease to the balance of the account.
		Optional	Validation:
		A2A	[0..1]
<Acct>		Account Identification	Counterpart account
		Mandatory	Validation:
		A2A	[1..1]
<Id>		Identification	
		Mandatory	Validation:
		A2A	[1..1]
<Othr>		GenericAccountIdentification	GenericAccountIdentification
		Mandatory	Validation:
			[1..1]
<Id>-</Id>	34x	Identification	Name or number assigned by an entity to enable recognition of that entity, eg, account identifier.
			Always the account identification of the T2S transit account.
		Mandatory	Validation:
		A2A	[1..1]
</Othr>		End of GenericAccountIdentification	End of GenericAccountIdentification

name of attribute	format	short description	description
		n	
		Mandatory	Validation: [1..1]
</Id>		End Identification	End Identification
		Mandatory	Validation: [1..1]
		A2A	
</Acct>		End of Account	
		Mandatory	Validation: [1..1]
		A2A	
<Ntry>		Information account statement report.	Information for an account statement report.
		Mandatory	Entry Time Validation: [1..1]
		A2A	
<Dt>		Date	Date and time choice
		Mandatory	Validation: [1..1]
<DtTm></DtTm>	ISODateTime	Date Time	
		Mandatory	Validation: [1..1]
		A2A	
</Dt>		End of Date	
		Mandatory	Validation: [1..1]
</Ntry>		End of Information account statement report	
		Mandatory	Validation: [1..1]
		A2A	
</AcctNtry>		End of Account Entry	End of Account Entry
		Mandatory	Validation: [1..1]
		A2A	
</Tx>		End Transaction	
		Mandatory	Validation: [1..1]
		A2A	
</TxOrErr>		End of TransactionOrErrorChoice	
		Mandatory	Validation: [1..1]
</TxRpt>		End Transaction Report	
		Mandatory	Validation: [1..n]
		A2A	
</BizRpt>		End of BusinessReport	End of BusinessReport
		Mandatory	Validation: [1..1]
		A2A	
<OprlErr>		OperationalError	Indicates an operational error

name of attribute	format	short description	description
			Rule description: If BusinessReport is present then OperationalError is not allowed. If BusinessReport is not present, then OperationalError is mandatory.
		Mandatory A2A	Validation: [1..1]
<Err>		Error handling Mandatory A2A	Validation: [1..1]
<Prtry>-</Prtry>	4x	Proprietary error code Mandatory A2A	Specification of the error, in free format. Validation: [1..1]
</Err>		End error handling Mandatory A2A	Validation: [1..1]
<Desc>-</Desc>	140x	Description Optional A2A	Validation: [0..1]
</OprlErr>		End of Operational Error Mandatory A2A	End of Operational Error Validation: [1..1]
/xorBizRptOprlErr		End of choice Mandatory	End of Choice Validation: End choice amongst BusinessReport <BizRpt> OperationalError <OprlErr>
</RptOrErr>		End of BusinessReportOrErrorChoi ce Optional	Validation:
</RtrTx>		End messagename ReturnTransaction Mandatory A2A	Validation:

Error Codes:

ReturnTransaction_T2SI_1

Scope: Transaction report for a single liquidity transfer to T2S.

MessageName for Return Transaction	<RtrTx>
Message Header	<MsgHdr>
Message Identification	<Msgld>123456</Msgld>
Original Business Query	<OrgnlBizQry>
Message Identification	<Msgld>ABC123</Msgld>
End of Original Business Query	</OrgnlBizQry>
End of Message Header	</MsgHdr>
BusinessReportOrErrorChoice	<RptOrErr>
BusinessReport	<BizRpt>
TransactionReport	<TxRpt>
PaymentIdentification	<PmtId>
ProprietaryId	<PrtryId>123455</PrtryId>
EndPaymentIdentification	</PmtId>
TransactionOrErrorChoice	<TxOrErr>
Transaction	<Tx>
Payment To	<PmtTo>
Member Identification	<Mmbld>
Financial Institution Identification	<FinInstnId>
BICFIIdentifier	<BICFI>TRGTXPMT2S</BICFI>
End of Financial Institution Identification	</FinInstnId>
End Member Identification	</Mmbld>
End PaymentTo	</PmtTo>
PaymentFrom	<PmtFr>
Member Identification	<Mmbld>
Financial Institution Identification	<FinInstnId>
BICFIIdentifier	<BICFI>MARKDEFFXXX</BICFI>
End Member Identification	</Mmbld>
End Payment From	</PmtFr>
Credit Debit Indicator	<CdtDbtInd>DBIT</CdtDbtInd>
Payment	<Pmt>
Message Identification	<Msgld>123450</Msgld>
PaymentStatus	<Sts>
PaymentStatusCode	<Cd>
Pending	<Fnl>PSTL</Fnl>
End of PaymentStatusCode	</Cd>
End of SystemStatus	</Sts>
InstructedAmount	<InstdAmt>
Amount without currency	<AmtWthtCcy>1000000.95</AmtWthtCcy>
End Instructed Amount	</InstdAmt>
PaymentMethod	<PmtMtd>
ProprietaryPaymentOriginType	<Prtry>T2SXML</Prtry>
End of Payment Method	</PmtMtd>
Priority	<Prty>
Priority Code	<Cd>HIGH</Cd>
End Priority	</Prty>
InstructionCopy	<InstrCpy><![CDATA[<AppHdr>...</AppHdr><Document>...</Document>]]></InstrCpy>
Type	<Tp>
Proprietary Payment Type	<PrtryPmtTp>LIQP</PrtryPmtTp>
End of Type	</Tp>

TransactionIdentification 16x						<TxId>ABCD1234</TxId>
Value date						<IntrBkSttlmDt>2014-11-11</IntrBkSttlmDt>
EndToEndIdentification						<EndToEndId>ABC12134</EndToEndId>
End of Payment						</Pmt>
AccountEntry						<AcctNtry>
Account Identification						<Acct>
Identification						<Id>
GenericAccountIdentification						<Othr>
Identification						<Id>EU00T2STRANSITACCOUNT</Id>
End of GenericAccountIdentification						</Othr>
End Identification						</Id>
End of Account						</Acct>
Information account statement report.						<Ntry>
Date						<Dt>
Date Time						<DtTm>2014-11-11T12:05:10</DtTm>
End of Date						</Dt>
End of Information account statement report						</Ntry>
End of Account Entry						</AcctNtry>
End Transaction						</Tx>
End of TransactionOrErrorChoice						</TxOrErr>
End Transaction Report						</TxRpt>
End of BusinessReport						</BizRpt>
End of BusinessReportOrErrorChoice						</RptOrErr>
End messagename ReturnTransaction						</RtrTx>

ReturnTransaction_T2SI_2

Scope: Report of error P013 "No payment found" because sender has not (successfully) initiated a transfer to T2S (eg due to errors in LiquidityCreditTransfer message).

Message name for Return Transaction	<RtrTx>
Message Header	<MsgHdr>
Message Identification	<MsgId>123456</MsgId>
Original Business Query	<OrgnlBizQry>
Message Identification	<MsgId>ABC123</MsgId>
End of Original Business Query	</OrgnlBizQry>
End of Message Header	</MsgHdr>
BusinessReportOrErrorChoice	<RptOrErr>
OperationalError	<OprlErr>
Error handling	<Err>
Proprietary error code	<Prtry>P013</Prtry>
End error handling	</Err>
Description	<Desc>No payment found</Desc>
End of Operational Error	</OprlErr>
End of BusinessReportOrErrorChoice	</RptOrErr>
End message name ReturnTransaction	</RtrTx>

6.13 XML messages related to CRSS

6.13. 1 BillingReport (for CBs only)

Cash Management Standard

BillingReport_CRSS

Scope: Every month, a BillingReport is pushed to CBs not having opted for CRISP module Store-and-Forward File Transfer Mode. This report gives the T2S consumption to be billed per RTGS.

The only standard supported by CRSS is "camt.077.001.01".

Structure:

Message Type	<BlgRpt>
Message Header	<MsgHdr>
Message Identification	<MsgId></MsgId>
RequestType	<ReqTp>
GenericIdentification	<Prtry>
Request type	<Id></Id>
End of GenericIdentification	</Prtry>
End of RequestType	</ReqTp>
End of Message Header	</MsgHdr>
BillingReportOrError	<BlgRptOrErr>
Message Type	<BlgRpt>
RegulatoryData	<RgltryData>
Invoicer	<Invcr>
Invoicer Name	<Nm></Nm>
Post Address	<PstlAdr>
StreetName	<StrtNm></StrtNm>
Building Number	<BldgNb></BldgNb>
Post Code	<PstCd></PstCd>
TownName	<TwnNm></TwnNm>
Country Sub Division	<CtrySubDvsn></CtrySubDvsn>
Country Code	<Ctry></Ctry>
End of Post Address	</PstlAdr>
ContactDetails	<CtctDtls>
Telephone Number	<PhneNb></PhneNb>
Email	<EmailAdr></EmailAdr>
End of ContactDetails	</CtctDtls>
End of Invoicer	</Invcr>
Invoicee	<Invcee>
Invoicee Name	<Nm></Nm>
Post Address	<PstlAdr>
StreetName	<StrtNm></StrtNm>
Building Number	<BldgNb></BldgNb>
Post Code	<PstCd></PstCd>
TownName	<TwnNm></TwnNm>
Country Sub Division	<CtrySubDvsn></CtrySubDvsn>
Country Code	<Ctry></Ctry>
End of Post Address	</PstlAdr>
End of Invoicee	</Invcee>
End of RegulatoryData	</RgltryData>
Invoice Date	<InvcDt></InvcDt>
Billing Identification	<BlgId></BlgId>
BillingPeriod	<BlgPrd>
Billing Period Start	<FrDt></FrDt>
Billing Period End	<ToDt></ToDt>

M

End of BillingPeriod	</BlIgPrd>
CSDOrNCB1Choice	<CSDOrNCB>
NCBIdentification	<NCBId></NCBId>
End of CSDOrNCB	</CSDOrNCB>
InvoiceTotals	<InvctTtls>
Invoice Totals Optional	<TtlInvAmt></TtlInvAmt>
End of InvoiceTotals	</InvctTtls>
Account Report	<SvcCtgyTtls>
Account Identification	<AcctId>
CashAccountIdentification	<CshAcctId>
GenericAccountIdentification	<Othr>
NCB Identification	<Id></Id>
End of GenericAccountIdentification	</Othr>
End of CashAccountIdentification	</CshAcctId>
End of Account Identification	</AcctId>
Billed Participant	<BlldCstmId></BlldCstmId>
Total amount	<TtlInvAmt></TtlInvAmt>
ServiceCategory	<SvcCtgy></SvcCtgy>
Service Item	<SvcltmTtls>
ItemType	<ItmTp></ItmTp>
Quantity	<Qty></Qty>
UnitPrice	<UnitPric></UnitPric>
Sub Total	<TtlInvAmt></TtlInvAmt>
End of ServiceItemTotals	</SvcltmTtls>
End of Account Report Mandatory	</SvcCtgyTtls>
End of BillingReport	</BlIgRpt>
End of BillingReportOrError	</BlIgRptOrErr>
End of Message Type	</BlIgRpt>

M

Attributes:

name of attribute	format	short description	description
<BlgRpt>		Message Type Mandatory	Validation: [1..1]
<MsgHdr>		Message Header Mandatory	Set of characteristics specific to the message Validation: [1..1]
<MsgId>-</MsgId>	16x	Message Identification Mandatory	Point to point reference, as assigned by the sender, to unambiguously identify the message. Validation: [1..1]
<ReqTp>		RequestType Mandatory	Validation: [1..1]
<Prtry>		GenericIdentification Mandatory	Validation: [1..1]
<Id>-</Id>	35x	Request type Mandatory	Request type Fixed value = « ITEM » Validation: [1..1]
</Prtry>		End of GenericIdentification Mandatory	Validation: [1..1]
</ReqTp>		End of RequestType Mandatory	Validation: [1..1]
</MsgHdr>		End of Message Header Mandatory	Validation: [1..1]
<BlgRptOrErr>		BillingReportOrError Mandatory	Validation: [1..1]
<BlgRpt>		Message Type Mandatory	Validation: [1..1]
<RgltryData>		RegulatoryData Mandatory	Validation: [1..1]
<Invcr>		Invoicer Mandatory	Validation: [1..1]
<Nm>-</Nm>	140x	Invoicer Name	Invoicer Name Data copied from the related input camt.077 received

M

name of attribute	format	short description	description
			from T2S
		Optional	Validation: [0..1]
<PstlAdr>		Post Address	
		Optional	Validation: [0..1]
<StrtNm>-</StrtNm>	70x	StreetName	Street Name Data copied from the related input camt.077 received from T2S
		Optional	Validation: [0..1]
<BldgNb>-</BldgNb>	16x	Building Number	Building Number Data copied from the related input camt.077 received from T2S
		Optional	Validation: [0..1]
<PstCd>-</PstCd>	16x	Post Code	Post Code Data copied from the related input camt.077 received from T2S
		Optional	Validation: [0..1]
<TwnNm>-</TwnNm>	35x	TownName	Town Name Data copied from the related input camt.077 received from T2S
		Optional	Validation: [0..1]
<CtrySubDvsn>-</CtrySubDvsn>	35x	Country Sub Division	Country Sub Division Data copied from the related input camt.077 received from T2S
		Optional	Validation: [0..1]
<Ctry>-</Ctry>	2!a	Country Code	Country Code
		Optional	Validation: [0..1]
</PstlAdr>		End of Post Address	
		Optional	Validation: [0..1]
<CtctDtls>		ContactDetails	
		Optional	Validation: [0..1]
<PhneNb>-</PhneNb>	35x	Telephone Number	Telephone Number Data copied from the related input camt.077 received from T2S
		Optional	Validation: [0..1]
<EmailAdr>-</EmailAdr>	2048x	Email	Email Data copied from the related input camt.077 received from T2S

name of attribute	format	short description	description
			Email Data copied from the related input camt.077 received from T2S
		Optional	Validation: [0..1]
</CtctDtls>		End of ContactDetails	
		Optional	Validation: [0..1]
</Invcr>		End of Invcrcr	
		Mandatory	Validation: [1..1]
<Invcee>		Invoicee	
		Mandatory	Validation: [1..1]
<Nm>-</Nm>	140x	Invoicee Name	Invoicee Name Data copied from the related input camt.077 received from T2S
		Optional	Validation: [0..1]
<PstlAdr>		Post Address	
		Optional	Validation: [0..1]
<StrtNm>-</StrtNm>	70x	StreetName	Street Name Data copied from the related input camt.077 received from T2S
		Optional	Validation: [0..1]
<BldgNb>-</BldgNb>	16x	Building Number	Building Number Data copied from the related input camt.077 received from T2S
		Optional	Validation: [0..1]
<PstCd>-</PstCd>	16x	Post Code	Post Code Data copied from the related input camt.077 received from T2S
		Optional	Validation: [0..1]
<TwnNm>-</TwnNm>	35x	TownName	Town Name Data copied from the related input camt.077 received from T2S
		Optional	Validation: [0..1]
<CtrySubDvsn>-</CtrySubDvsn>	35x	Country Sub Division	Country Sub Division Data copied from the related input camt.077 received from T2S
		Optional	Validation: [0..1]
<Ctry>-</Ctry>	2!a	Country Code	Country Code

name of attribute	format	short description	description
		Optional	Code to identify a country, a dependency, or another area of particular geopolitical interest, on the basis of country names obtained from the United Nations (ISO 3166, Alpha-2 code). Validation: [0..1]
</PstlAdr>		End of Post Address Optional	Validation: [0..1]
</Invcee>		End of Invoicee Mandatory	Validation: [1..1]
</RgltryData>		End of RegulatoryData Mandatory	Validation: [1..1]
<InvcDt>-</InvcDt>	YYYY-MM-DD	Invoice Date Mandatory	Invoice Date Data copied from the related input camt.077 received from T2S Validation: [1..1]
<BlldId>-</BlldId>	16x	Billing Identification Mandatory	Billing Identification Data copied from the related input camt.077 received from T2S Validation: [1..1]
<BlldPrd>		BillingPeriod Mandatory	Validation: [1..1]
<FrDt>-</FrDt>	YYYY-MM-DD	Billing Period Start Mandatory	Billing Period Start Data copied from the related input camt.077 received from T2S Validation: [1..1]
<ToDt>-</ToDt>	YYYY-MM-DD	Billing Period End Mandatory	Billing Period End Data copied from the related input camt.077 received from T2S Validation: [1..1]
</BlldPrd>		End of BillingPeriod Mandatory	Validation: [1..1]
<CSDOrNCB>		CSDOrNCB1Choice Optional	Choice between a central securities depository or a national central bank for querying party reference data Validation: [0..1]
<NCBId>-</NCBId>	4!a2!a2!c3!c	NCBIdentification	NCB Identification Data copied from the related input camt.077 received from T2S

name of attribute	format	short description	description
		Mandatory	Validation: [1..1]
</CSDOrNCB>		End of CSDOrNCB	
		Optional	Validation: [0..1]
<InvcTtls>		InvoiceTotals	
		Mandatory	Validation: [1..1]
<TtlInvcAmt>-</TtlInvcAmt>	Amount	Invoice Totals Optional	Invoice Total in euro = 0.00
		Mandatory	Validation: [1..1]
</InvcTtls>		End of InvoiceTotals	
		Mandatory	Validation: [1..1]
<SvcCtgyTtls>		Account Report	Account Report
		Mandatory	Validation: [1..n]
<AcctId>		Account Identification	Account Identification
		Optional	Validation: [0..1]
<CshAcctId>		CashAccountIdentification	
		Mandatory	Validation: [1..1]
<Othr>		GenericAccountIdentification	GenericAccountIdentification
		Mandatory	Validation: [1..1]
<Id>-</Id>	34x	NCB Identification	RTGS account number of the billed direct participant
		Mandatory	Validation: [1..1]
</Othr>		End of GenericAccountIdentification	End of GenericAccountIdentification
		Mandatory	Validation: [1..1]
</CshAcctId>		End of CashAccountIdentification	
		Mandatory	Validation: [1..1]
</AcctId>		End of Account Identification	End Account Identification
		Optional	Validation: [0..1]
<BldCstmrId>-</BldCstmrId>	4!a2!a2!c3!c	Billed Participant	BIC of the billed direct participant
		Optional	Validation:

name of attribute	format	short description	description
			[0..1]
<TtlInvcAmt>-</TtlInvcAmt>	Amount	Total amount	Total amount in euros for this direct participant for the category
		Mandatory	Validation: [1..1]
<SvcCtgy>-</SvcCtgy>	4x	ServiceCategory	Service Category:“SETT” “INSV” “ACMS”
		Mandatory	Validation: [1..1]
<SvcltmTtls>		Service Item	Service Item
		Optional	Validation: [0..n]
<ItmTp>-</ItmTp>	4x	ItemType	Item Type code : 9001, 9002, 9003, 9004, 9005, 9006, 9007, 9008, 9009, 9010, 9011, 9012, 9013, 9014, 9015
		Mandatory	Validation: [1..1]
<Qty>-</Qty>	Integer	Quantity	Quantity
		Mandatory	Validation: [1..1]
<UnitPric>-</UnitPric>	Amount	UnitPrice	Unit Price in euro = 0.00
		Mandatory	Validation: [1..1]
<TtlInvcAmt>-</TtlInvcAmt>	Amount	Sub Total	Sub Total in euro = 0.00
		Mandatory	Validation: [1..1]
</SvcltmTtls>		End of ServiceItemTotals	
		Optional	Validation: [0..n]
</SvcCtgyTtls>		End of Account Report	
		Mandatory	Validation: [1..n]
</BllgRpt>		End of BillingReport	
		Mandatory	Validation: [1..1]
</BllgRptOrErr>		End of BillingReportOrError	
		Mandatory	Validation: [1..1]
</BllgRpt>		End of Message Type	
		Mandatory	Validation: [1..1]

M

Error Codes:

6.14 XML messages related to TIPS!

6.14.1 BankToCustomerDebitCreditNotification

Cash Management Standard

BankToCustomerDebitCreditNotification_TIPSI

M

Scope: The BankToCustomerDebitCreditNotification message is pushed to the account holder in case of liquidity transfers to TIPS if not initiated by the account holder himself via XML message. In other words, if he is not notified about liquidity transfer with TIPS via a payment message (LiquidityCreditTransfer).

The XML message informs about the amount settled in the RTGS account, names the destination DCA and provides the originally instructed amount if deviating from settlement amount (possible in case of standing orders).

The BankToCustomerDebitCreditNotification message will always be sent as "camt.054.001.06".

Structure:

BankToCustomerDebitCreditNotification	<BkToCstmrDbtCdtNtfctn>
GroupHeader	<GrpHdr>
Message Identification	<MsgId>-</MsgId>
CreationDateTime	<CreDtTm>-</CreDtTm>
EndGroupHeader	</GrpHdr>
Notification	<Ntfctn>
Message business identification	<Id>-</Id>
CreationDateTime	<CreDtTm>-</CreDtTm>
Account Identification	<Acct>
Identification	<Id>
GenericAccountIdentification	<Othr>
Identification	<Id>-</Id>
End of GenericAccountIdentification	</Othr>
End Identification	</Id>
End of Account	</Acct>
Information account statement report.	<Ntry>
Amount	<Amt>-</Amt>
Credit or debit indicator	<CdtDbtInd>-</CdtDbtInd>
Payment status	<Sts>-</Sts>
BookingDate	<BookgDt>
Date Time	<DtTm>-</DtTm>
End of BookingDate	</BookgDt>
BankTransactionCode	<BkTxCd>
Domain	<Domn>
FamilyCode	<Cd>-</Cd>
Family	<Fmly>
FamilyCode	<Cd>-</Cd>
SubFamilyCode	<SubFmlyCd>-</SubFmlyCd>
End of Family	</Fmly>
End of Domain	</Domn>
End of BankTransactionCode	</BkTxCd>
EntryDetails	<NtryDtls>
TransactionDetails	<TxDtls>
References	<Refs>
AccountServicerReference	<AcctSvcrRef>-</AcctSvcrRef>
InstructionIdentification	<InstrId>-</InstrId>
EndToEndIdentification	<EndToEndId>-</EndToEndId>
AccountServicerTransactionID	<AcctSvcrTxId>-</AcctSvcrTxId>
End of References	</Refs>
Amount	<Amt>-</Amt>
Credit or debit indicator	<CdtDbtInd>-</CdtDbtInd>

M

AmountDetails	<AmtDtls>
Instructed Amount	<InstdAmt>
Amount	<Amt></Amt>
End Instructed Amount	</InstdAmt>
End of AmountDetails	</AmtDtls>
RelatedParties	<RltdPties>
Account Identification Credit	<CdtAcct>
Identification	<Id>
GenericAccountIdentification	<Othr>
Identification	<Id></Id>
End of GenericAccountIdentification	</Othr>
End Identification	</Id>
End of Account Identification Credit	</CdtAcct>
End of RelatedParties	</RltdPties>
End of TransactionDetails	</TxDtls>
End of EntryDetails	</NtryDtls>
End of Entry	</Ntry>
End of Notification	</Ntfctn>
End of BankToCustomerDebitCreditNotification	</BkToCstmrDbtCdtNtfctn>

D
D
D
D
D
D
D

M

Attributes:

name of attribute	format	short description	description
<BkToCstmrDbtCdtNtfctn>		BankToCustomerDebitCreditNotification Mandatory	Validation: [1..1]
<GrpHdr>		GroupHeader Mandatory	Validation: [1..1]
<MsgId></MsgId>	16x	Message Identification Mandatory	String of characters that uniquely identifies a message Point to point reference, as assigned by the sender, to unambiguously identify the message. Value: MESSAGE_ID generated by PM for the outgoing camt.054 Validation: [1..1]
<CreDtTm></CreDtTm>	ISODateTime	CreationDateTime Mandatory	Date and time when the message has been created. Date and time at which the message is created. Validation: [1..1]
</GrpHdr>		EndGroupHeader Mandatory	Validation: [1..1]
<Ntfctn>		Notification Mandatory	Validation: [1..1]
<Id></Id>	16x	Message business identification Mandatory	String of characters that uniquely identifies a message at senders side. Unique and unambiguous identifier for a message, as assigned by the Sender. This unique identifier can be used for cross-referencing purposes in subsequent messages. Unique identification to unambiguously identify the account notification. The notification notifies debit and credit entries for the account. Value: Equal to MessageID (since T2 has only 1 notification per message). Validation: [1..1]
<CreDtTm></CreDtTm>	ISODateTime	CreationDateTime Mandatory	Date and time when the message has been created. Date and time at which the message is created. Equal to CreationDateTime. Validation: [1..1]
<Acct>		Account Identification Mandatory	Validation: [1..1]
<Id>		Identification Mandatory	Validation: [1..1]
<Othr>		GenericAccountIdentification Mandatory	GenericAccountIdentification Validation: [1..1]

name of attribute	format	short description	description
<Id>-</Id>	34x	Identification Mandatory	Name or number assigned by an entity to enable recognition of that entity, eg, account identifier. Unambiguous identification of the RTGS account to which debit (or credit) entry was made. Validation: [1..1]
</Othr>		End of GenericAccountIdentification Mandatory	End of GenericAccountIdentification Validation: [1..1]
</Id>		End Identification Mandatory	End of EntityIdentifier Validation: [1..1]
</Acct>		End of Account Mandatory	End of Account Validation: [1..1]
<Ntry>		Information account statement report. Mandatory	Information for an account statement report. Validation: [1..1]
<Amt>-</Amt>	15d	Amount Mandatory	Amount (with implied currency) Amount of money in the cash entry identifies the available amount. This element must be used with the XML attribute Currency (Ccy="EUR"). Value: amount settled in the RTGS account Validation: [1..1]
<CdtDbtInd>-</CdtDbtInd>	4!a	Credit or debit indicator Mandatory	CRDT = Credit Operation is an increase. DBIT = Debit Operation is a decrease. Indicates whether the availability balance is a credit or a debit balance. ("CRDT" = credit entry / "DBIT" = debit entry) Fixed value: "DBIT" Validation: [1..1]
<Sts>-</Sts>	4!c	Payment status Mandatory	Transaction status of an entry on the books of the account servicer. Fixed value: "BOOK" (=booked), because T2 sends out the notification only after successful settlement. Validation: [1..1]
<BookgDt>		BookingDate Mandatory	 Validation: [1..1]
<DtTm>-</DtTm>	ISODateTime	Date Time	ISO definition: Date and time when an entry is posted to an account on the account servicer's books. Value: BUSI_DATE(yyyy-mm-dd)"T"settlement

name of attribute	format	short description	description
		Mandatory	time(hh:mm:ss) Validation: [1..1]
</BookgDt>		End of BookingDate Mandatory	Validation: [1..1]
<BkTxCd>		BankTransactionCode Mandatory	Validation: [1..1]
<Domn>		Domain Mandatory	Validation: [1..1]
<Cd>-</Cd>	4!c	FamilyCode Mandatory	Fixed value: "PMNT" (=Payments area) Specifies the business area of the underlying transaction resulting in an entry. Validation: [1..1]
<Fmly>		Family Mandatory	Validation: [1..1]
<Cd>-</Cd>	4!c	FamilyCode Mandatory	Specifies the family within a domain. Following codes are supported: "ICDT" Issued Credit Transfers (to TIPS) Note: As mentioned above, only debit notifications will be sent if no payment message is used to notify the account owner. Therefore, only the first code is needed. Validation: [1..1]
<SubFmlyCd>-</SubFmlyCd>	4!c	SubFamilyCode Mandatory	Specifies the sub-product family within a specific family. In case of FamilyCode = "ICDT" following values are possible: "STDO" standing order liquidity transfer to TIPS "FICT" current order Financial Institution Credit Transfer Note: As mentioned above, only debit notifications will be sent if no payment message is used to notify the account owner. Therefore, only the first two codes related to Issued Credit Transfers are needed. Validation: [1..1]
</Fmly>		End of Family Mandatory	Validation: [1..1]
</Domn>		End of Domain Mandatory	Validation: [1..1]
</BkTxCd>		End of BankTransactionCode Mandatory	Validation: [1..1]
<NtryDtls>		EntryDetails	

name of attribute	format	short description	description
		Mandatory	Validation: [1..1]
<TxDtls>		TransactionDetails Mandatory	Validation: [1..1]
<Refs>		References Mandatory	Validation: [1..1]
<AcctSvcrRef>- </AcctSvcrRef>	16x	AccountServicerReference Mandatory	SSP Business Case ID Value: BUSI_CASE_ID (Unique identification of the business case, generated by PM.) Validation: [1..1]
<InstrId>-</InstrId>	16x	InstructionIdentification Mandatory	Unique and unambiguous identifier for a payment instruction assigned by the initiating party Unique identification assigned by the sender of the payment message. Value: CASE SELECT Business Case initiated via Standing Order: SspBookingId (generated by PM) ICM current order: SspBookingId (generated by PM) Validation: [1..1]
<EndToEndId>- </EndToEndId>	16x	EndToEndIdentification Mandatory	Unique and unambiguous identification of a payment transaction, as assigned by any of the parties on the initiating side, that will be passed on throughout the entire end-to-end chain Unique identification assigned by the initiating party (TIPS account owner/RTGS account owner) to unambiguously identify the transaction. This identification is passed on, unchanged, throughout the entire end-to-end chain. Value: CASE SELECT Business Case initiated via Standing Order: BUSI_CASE_ID (generated by PM) ICM current order: BUSI_CASE_ID (generated by PM) Validation: [1..1]
<AcctSvcrTxId>- </AcctSvcrTxId>	16x	AccountServicerTransactionID Mandatory	SSP Booking ID Unique identification of the payment, generated by PM Validation: [1..1]
</Refs>		End of References Mandatory	Validation: [1..1]
<Amt>-</Amt>	15d	Amount Mandatory	Amount (with implied currency) Settlement amount of the single cash transaction. This must be used with the XML attribute Currency (Ccy="EUR"). Value: amount settled in the RTGS account Validation: [1..1]
<CdtDbtInd>-</CdtDbtInd>	4!a	Credit or debit indicator	CRDT = Credit Operation is an increase.

name of attribute	format	short description	description
			DBIT = Debit Operation is a decrease. Indicates whether the transaction is a credit or a debit transaction. ("CRDT2 = credit entry / "DBIT" = debit entry) Fixed value: "DBIT"
		Mandatory	Validation: [1..1]
<AmtDtls>		AmountDetails	
		Optional	Validation: [0..1]
<InstdAmt>		Instructed Amount	
		Mandatory	Validation:
<Amt>-</Amt>	15d	Amount	Amount (with implied currency) Amount of money instructed for movement between the debtor and creditor. = Standing order amount (entered via screen 03-02-03-04 Display and Enter Standing Order Liquidity TIPS account). The optional element is only used in case of partial settlement in T2 and must be used with the XML attribute Currency: Ccy="EUR"
		Mandatory	Validation: [1..1]
</InstdAmt>		End Instructed Amount	End Instructed Amount
		Mandatory	Validation: [1..1]
</AmtDtls>		End of AmountDetails	
		Optional	Validation: [0..1]
<RltdPties>		RelatedParties	
		Mandatory	Validation: [1..1]
			Validation:
			Validation:
			Validation:
			Validation:

D

D

D

D

name of attribute	format	short description	description	
				D
			Validation:	
				D
			Validation:	
				D
			Validation:	
<CdtAcct>		Account Identification Credit	Account Details Account credited as a result of a credit entry.	
		Mandatory	Validation: [1..1]	
<Id>		Identification Mandatory	Validation: [1..1]	
<Othr>		GenericAccountIdentificatio n Mandatory	GenericAccountIdentification Validation: [1..1]	
<Id></Id>	34x	Identification Mandatory	Name or number assigned by an entity to enable recognition of that entity, eg, account identifier. Unambiguous identification of the account of the related (Debtor or) Creditor in TIPS. In case of CreditDebitIndicator = "DBIT" the Creditor Account ID is used. (In case of CreditDebitIndicator = "CRDT" the Debtor Account ID is used.) Validation: [1..1]	M
</Othr>		End of GenericAccountIdentificatio n Mandatory	End of GenericAccountIdentification Validation: [1..1]	
</Id>		End Identification Mandatory	End of EntityIdentifier Validation: [1..1]	
</CdtAcct>		End of Account Identification Credit Mandatory	Validation: [1..1]	
</RltdPties>		End of RelatedParties Mandatory	Validation: [1..1]	
</TxDtls>		End of TransactionDetails		

name of attribute	format	short description	description
		Mandatory	Validation: [1..1]
</NtryDtIs>		End of EntryDetails Mandatory	Validation: [1..1]
</Ntry>		End of Entry Mandatory	Validation: [1..1]
</Ntfctn>		End of Notification Mandatory	Validation: [1..1]
</BkToCstmrDbtCdtNtfctn>		End of BankToCustomerDebitCred itNotification Mandatory	Validation: [1..1]

Error Codes:

BankToCustomerDebitCreditNotification_TIPSI

Scope:

BankToCustomerDebitCreditNotification	<BkToCstmrDbtCdtNfctn>
GroupHeader	<GrpHdr>
Message Identification	<MsgId>1234567890123456</MsgId>
CreationDateTime	<CreDtTm>2018-01-03T08:20:15</CreDtTm>
EndGroupHeader	</GrpHdr>
Notification	<Nfctn>
Message business identification	<Id>1234567890123456</Id>
CreationDateTime	<CreDtTm>2018-01-03T08:20:15</CreDtTm>
Account Identification	<Acct>
Identification	<Id>
GenericAccountIdentification	<Othr>
Identification	<Id>DE11RTGS0000123</Id>
End of GenericAccountIdentification	</Othr>
End Identification	</Id>
End of Account	</Acct>
Information account statement report.	<Ntry>
Amount	<Amt Ccy=>1000000.00</Amt>
Credit or debit indicator	<CdtDbtInd>DBIT</CdtDbtInd>
Payment status	<Sts>BOOK</Sts>
BookingDate	<BookgDt>
Date Time	<DtTm>2018-01-03T08:20:15</DtTm>
End of BookingDate	</BookgDt>
BankTransactionCode	<BkTxCd>
Domain	<BkTxCd>
FamilyCode	<Cd>PMNT</Cd>
Family	<Fmly>
FamilyCode	<Cd>ICDT</Cd>
SubFamilyCode	<SubFmlyCd>FIDD</SubFmlyCd>
End of Family	</Fmly>
End of Domain	</Domn>
End of BankTransactionCode	</BkTxCd>
EntryDetails	<NtryDtls>
TransactionDetails	<TxDtls>
References	<Refs>
AccountServicerReference	<AcctSvcrRef>1234567890123456</AcctSvcrRef>
InstructionIdentification	<InstrId>ID-123456789123</InstrId>
EndToEndIdentification	<EndToEndId>E2E-001</EndToEndId>
AccountServicerTransactionID	<AcctSvcrTxId>15987456</AcctSvcrTxId>
End of References	</Refs>
Amount	<Amt Ccy="EUR">1000000.00</Amt>
Credit or debit indicator	<CdtDbtInd>DBIT</CdtDbtInd>
AmountDetails	<AmtDtls>
Instructed Amount	<InstdAmt>
Amount	<Amt Ccy="EUR">1000000.00</Amt>
End Instructed Amount	</InstdAmt>
End of AmountDetails	</AmtDtls>
RelatedParties	<RltdPties>

Account Identification Credit	<CdtAcct>
Identification	<Id>
GenericAccountIdentification	<Othr>
Identification	<Id>DE11DCA000012345</Id>
End of GenericAccountIdentification	</Othr>
End Identification	</Id>
End of Account Identification Credit	</CdtAcct>
End of RelatedParties	</RltdPties>
End of TransactionDetails	</TxDtls>
End of EntryDetails	</NtryDtls>
End of Entry	</Ntry>
End of Notification	</Ntfctn>
End of BankToCustomerDebitCreditNotification	</BkToCstmrDbtCdtNtfctn>

6.14.2 GetAccount

Cash Management Standard

GetAccount_TIPSI

Scope: This message is sent by RTGS account owners to receive information on TIPS account balances of their linked accounts. It may also be used by GoA managers or CBs on behalf of their participants. The number of requested accounts is restricted to the maximum number of linked accounts (10).

TIPSI only supports one version of request message GetAccount (camt.003.001.06).
The related query response message is ReturnAccount (camt.004.001.07).

Structure:

Message Type	<GetAcct>
Message Header	<MsgHdr>
Message Identification	<MsgId>-</MsgId>
End of Message Header	</MsgHdr>
Account Query Definition	<AcctQryDef>
Account Criteria	<AcctCrit>
NewCriteria	<NewCrit>
SearchCriteria	<SchCrit>
Account Identification	<AcctId>
AccountIdentificationChoice	<EQ>
GenericAccountIdentification	<Othr>
Identification	<Id>-</Id>
End of GenericAccountIdentification	</Othr>
End of AccountIdentificationChoice	</EQ>
End of Account Identification	</AcctId>
End of SearchCriteria	</SchCrit>
End of NewCriteria	</NewCrit>
End Account Criteria	</AcctCrit>
End of AccountQueryDefinition	</AcctQryDef>
End of Message Type	</GetAcct>

Attributes:

name of attribute	format	short description	description
<GetAcct>		Message Type	Message name for GetAccount
		Mandatory	Validation: [1..1]
<MsgHdr>		Message Header	Set of characteristics specific to the message
		Mandatory	Validation: [1..1]
<MsgId></MsgId>	16x	Message Identification	String of characters that uniquely identifies a message Point to point reference, as assigned by the sender, to unambiguously identify the message.
		Mandatory	Validation: [1..1]
</MsgHdr>		End of Message Header	
		Mandatory	Validation: [1..1]
<AcctQryDef>		Account Query Definition.	
		Mandatory	Validation: [1..1]
<AcctCrit>		Account Criteria	
		Mandatory	Validation: [1..1]
<NewCrit>		NewCriteria	
		Mandatory	Validation: [1..1]
<SchCrit>		SearchCriteria	
		Mandatory	Validation: [1..10]
<AcctId>		Account Identification	Account Identification Balances of one or several TIPS accounts may be requested.
		Mandatory	Validation: [1..1]
<EQ>		AccountIdentificationChoice	AccountIdentificationChoice
		Mandatory	Validation: [1..1]
<Othr>		GenericAccountIdentification	GenericAccountIdentification
		Mandatory	Validation: [1..1]
<Id></Id>	34x	Identification	Name or number assigned by an entity to enable recognition of that entity, eg, account identifier. Account identification of the TIPS account
		Mandatory	Validation: [1..1]
</Othr>		End of GenericAccountIdentification	End of GenericAccountIdentification

name of attribute	format	short description	description
		Mandatory	Validation: [1..1]
</EQ>		End of AccountIdentificationChoice	End of search for one or more accounts based on exact identification of the account(s).
		Mandatory	Validation: [1..1]
</AcctId>		End of Account Identification	
		Mandatory	Validation: [1..1]
</SchCrit>		End of SearchCriteria	End of SearchCriteria
		Mandatory	Validation: [1..10]
</NewCrit>		End of NewCriteria	End of NewCriteria
		Mandatory	Validation: [1..1]
</AcctCrit>		End Account Criteria	
		Mandatory	Validation: [1..1]
</AcctQryDef>		End of AccountQueryDefinition	End of AccountQueryDefinition
		Mandatory	Validation: [1..1]
</GetAcct>		End of Message Type	End of GetAccount
		Mandatory	Validation: [1..1]

Error Codes:

GetAccount_TIPSI

Scope:

Message Type	<GetAcct>
Message Header	<MsgHdr>
Message Identification	<MsgId>123XYZ</MsgId>
End of Message Header	</MsgHdr>
Account Query Definition.	<AcctQryDef>
Account Criteria	<AcctCrit>
NewCriteria	<NewCrit>
SearchCriteria	<SchCrit>
Account Identification	<AcctId>
AccountIdentificationChoice	<EQ>
GenericAccountIdentification	<Othr>
Identification	<Id>DE11DCA0000123</Id>
End of GenericAccountIdentification	</Othr>
End of AccountIdentificationChoice	</EQ>
End of Account Identification	</AcctId>
End of SearchCriteria	</SchCrit>
End of NewCriteria	</NewCrit>
End Account Criteria	</AcctCrit>
End of AccountQueryDefinition	</AcctQryDef>
End of Message Type	</GetAcct>

6.14.3 LiquidityCreditTransfer

Cash Management Standard

LiquidityCreditTransfer_TIPSI

Scope: The LiquidityCreditTransfer message can only be sent in Store-and-Forward mode to TIPSI. Senders can be

- 1) T2 participants for own account,
- 2) CB on behalf of a participant being responsible for.
- 3) Managers of Group of Accounts on behalf of their group members

T2 actors can initiate liquidity transfers to TIPS and from TIPS via T2 message.

The only standard supported by TIPSI is camt.050.001.04.

Structure:

LiquidityCreditTransfer1	<LqdyCdtTrf>	
Message Header	<MsgHdr>	
Message Identification	<MsgId>-</MsgId>	
End of Message Header	</MsgHdr>	
LiquidityCreditTransfer1	<LqdyCdtTrf>	
LiquidityTransferIdentification	<LqdyTrfId>	
InstructionIdentification	<InstrId>-</InstrId>	
EndToEndIdentification	<EndToEndId>-</EndToEndId>	
End of LiquidityTransferIdentification	</LqdyTrfId>	
Creditor	<Cdtr>	
Financial Institution Identification	<FinInstnId>	
BICFIIdentifier	<BICFI>-</BICFI>	
End of Financial Institution Identification	</FinInstnId>	
End of Creditor	</Cdtr>	
CreditorAccount Identification	<CdtrAcct>	M
GenericAccountIdentification	<Id>	
NCB Identification	<Othr>	
End of GenericAccountIdentification	<Id>-</Id>	
End Identification	</Othr>	
CashAccountType	<Tp>	
RestrictionTypeCode	<Cd></Cd>	
End of CashAccountType	</Tp>	
EndCreditorAccount	</CdtrAcct>	M
Transferred Amount	<TrfdAmt>	
AmountWithCurrency	<AmtWthCcy Ccy="EUR"></AmtWthCcy>	M D
End of Transferred Amount	</TrfdAmt>	
Debtor	<Dbtr>	
Financial Institution Identification	<FinInstnId>	
BICFIIdentifier	<BICFI>-</BICFI>	
End of Financial Institution Identification	</FinInstnId>	
End of debtor	</Dbtr>	
DebtorAccount Identification	<DbtrAcct>	M
GenericAccountIdentification	<Id>	
NCB Identification	<Othr>	
End of GenericAccountIdentification	<Id>-</Id>	
End Identification	</Othr>	
BalanceTypeCode	<Tp>	
RestrictionTypeCode	<Cd></Cd>	

End of CashAccountType

EndDebtorAccount

SettlementDate

End of LiquidityCreditTransfer1

End of LiquidityCreditTransfer1

```
| | | </Tp>  
| | | </DbtrAcct>  
| | | <SttlmDt>-</SttlmDt>  
| | | </LqdyCdtTrf>  
| | | </LqdyCdtTrf>
```

M

Attributes:

name of attribute	format	short description	description
<LqdyCdtTrf>		LiquidityCreditTransfer1 Mandatory	LiquidityCreditTransfer Validation: [1..1]
<MsgHdr>		Message Header Mandatory	Set of characteristics specific to the message Validation: [1..1]
<MsgId>-</MsgId>	35x	Message Identification Mandatory	Message Identification Point to point reference, as assigned by the sender (DN), to unambiguously identify the message. Validation: [1..1]
</MsgHdr>		End of Message Header Mandatory	Validation: [1..1]
<LqdyCdtTrf>		LiquidityCreditTransfer1 Mandatory	LiquidityCreditTransfer Validation: [1..1]
<LqdyTrfld>		LiquidityTransferIdentificatio n Optional	Set of liquidity transfer references. Validation: [0..1]
<InstrId>-</InstrId>	16x	InstructionIdentification Optional	Unique and unambiguous identifier for a payment instruction assigned by the initiating party Unique identification as assigned by the instructing party (=sender) to unambiguously identify the instruction. Validation: [0..1]
<EndToEndId>-</EndToEndId>	16x	EndToEndIdentification Mandatory	Unique and unambiguous identification of a payment transaction, as assigned by any of the parties on the initiating side, that will be passed on throughout the entire end-to-end chain Unique identification assigned by the initiating party (TIPS account/RTGS account owner) to unambiguously identify the transaction. This identification is passed on, unchanged, throughout the entire end-to-end chain. Validation: [1..1]
</LqdyTrfld>		End of LiquidityTransferIdentificatio n Optional	Validation: [0..1]
<Cdtr>		Creditor Optional	Creditor Validation: [0..1]
<FinInstnId>		Financial Institution Identification Mandatory	Financial Institution Identification Validation:

name of attribute	format	short description	description
			[1..1]
<BICFI></BICFI>	4!a2!a2!c3!c	BICFIIdentifier Optional	BICFIIdentifier BIC identifier of the credit account holder This element is only filled in case of "pull liquidity" Validation: [0..1]
</FinInstId>		End of Financial Institution Identification Mandatory	End of Financial Institution Identification Validation: [1..1]
</Cdtr>		End of Creditor Optional	Validation: [0..1]
<CdtrAcct>		CreditorAccount Optional	Validation: [0..1]
<Id>		Identification Mandatory	Identification Unique and unambiguous identification for the account between the account owner and the account servicer. Validation: [1..1]
<Othr>		GenericAccountIdentification Mandatory	GenericAccountIdentification Validation: [1..1]
<Id></Id>	34x	NCB Identification Mandatory	RTGS account number of the billed direct participant Either filled with TIPS account number or RTGS account number, depending on the given CreditAccountTypeCode. Validation: [1..1]
</Othr>		End of GenericAccountIdentification Mandatory	End of GenericAccountIdentification Validation: [1..1]
</Id>		End Identification Mandatory	End of EntityIdentifier Validation: [1..1]
<Tp>		CashAccountType Optional	CashAccountType Validation: [0..1]
<Cd></Cd>	4!c	RestrictionTypeCode	RestrictionTypeCode T2S restriction type codes for Dedicated Cash Account Balance Query. - Possible values are: "BLCK" - Blocking "CSDB" - CoSDBlocking "EARM" - Earmarking "EFAC" - EarmarkingForAutoCollateralisation "RSVT" - Reservation

M

name of attribute	format	short description	description
		Mandatory	"CASH" = TIPS Account "SACC" = T2 RTGS Account (used in case of "pull liquidity") Validation: [1..1]
</Tp>		End of CashAccountType	End of CashAccountType
		Optional	Validation: [0..1]
</CdtrAcct>		EndCreditorAccount Optional	Validation: [0..1]
<TrfdAmt>		Transferred Amount	The amount may be defined with or without the currency. <AmtWthCcy> CurrencyAndAmount <AmtWthtCcy> ImpliedCurrencyAndAmount
		Mandatory	Validation: [1..1]
<AmtWthCcy>		AmountWithCurrency	Number of monetary units specified in a currency where the unit of currency is explicit. This element is used in T2 participant messages. – No currency attribute available. Value must be larger than 0. Leading zeros and such after the two fraction digits are ignored by TIPS!
		Mandatory	Validation: [1..1]
			Validation:
</TrfdAmt>		End of Transferred Amount	
		Mandatory	Validation: [1..1]
<Dbtr>		Debtor	Information about the debtor of a payment.
		Mandatory	Validation: [1..1]
<FinInstnId>		Financial Institution Identification	Financial Institution Identification
		Mandatory	Validation: [1..1]
<BICFI>-</BICFI>	4!a2!a2!c3!c	BICFIIdentifier	BICFIIdentifier BIC identifier of the debit account holder
		Optional	Validation: [0..1]
</FinInstnId>		End of Financial Institution Identification	End of Financial Institution Identification
		Mandatory	Validation: [1..1]
</Dbtr>		End of debtor	
		Mandatory	Validation:

name of attribute	format	short description	description
			[1..1]
<DbtrAcct>		DebtorAccount Optional	Validation: [0..1]
<Id>		Identification Mandatory	Identification Unique and unambiguous identification for the account between the account owner and the account servicer. Validation: [1..1]
<Othr>		GenericAccountIdentification Mandatory	GenericAccountIdentification Validation: [1..1]
<Id>-</Id>	34x	NCB Identification Mandatory	RTGS account number of the billed direct participant Either filled with TIPS account number or RTGS account number, depending on the given DebitAccountTypeCode. Validation: [1..1]
</Othr>		End of GenericAccountIdentification Mandatory	End of GenericAccountIdentification Validation: [1..1]
</Id>		End Identification Mandatory	End of EntityIdentifier Validation: [1..1]
<Tp>		BalanceTypeCode Optional	Validation: [0..1]
<Cd>-</Cd>	4!c	RestrictionTypeCode Mandatory	RestrictionTypeCode T2S restriction type codes for Dedicated Cash Account Balance Query. - Possible values are: "BLCK" - Blocking "CSDB" - CoSDBlocking "EARM" - Earmarking "EFAC" - EarmarkingForAutoCollateralisation "RSVT" - Reservation "CASH" = TIPS Account "SACC" = T2 RTGS Account (used in case of "pull liquidity") Validation: [1..1]
</Tp>		End of CashAccountType Optional	End of CashAccountType Validation: [0..1]
</DbtrAcct>		EndDebtorAccount Optional	Validation: [0..1]
<Stlmdt>-</Stlmdt>	ISODate	SettlementDate	Requested settlement date = SSP Business Day.

name of attribute	format	short description	description
		Optional	Past or future dates are not allowed in TIPS1. Validation: [0..1]
</LqdyCdtTrf>		End of LiquidityCreditTransfer1 Mandatory	End of LiquidityCreditTransfer Validation: [1..1]
</LqdyCdtTrf>		End of LiquidityCreditTransfer1 Mandatory	End of LiquidityCreditTransfer Validation: [1..1]

Error Codes:

LiquidityCreditTransfer_TIPSI

Scope:

LiquidityCreditTransfer1	<LqdyCdtTrf>	
Message Header	<MsgHdr>	
Message Identification	<MsgId>1234XYZ</MsgId>	
End of Message Header	</MsgHdr>	
LiquidityCreditTransfer1	<LqdyCdtTrf>	
LiquidityTransferIdentification	<LqdyTrfId>	
InstructionIdentification	<InstrId>123456XYZ</InstrId>	
EndToEndIdentification	<EndToEndId>123458ZYX</EndToEndId>	
End of LiquidityTransferIdentification	</LqdyTrfId>	
Creditor	<Cdtr>	
Financial Institution Identification	<FinInstnId>	
BICFIIdentifier	<BICFI>ABCDWXYZ</BICFI>	
End of Financial Institution Identification	</FinInstnId>	
End of Creditor	</Cdtr>	
CreditorAccount	<CdtrAcct>	M
Identification	<Id>	
GenericAccountIdentification	<Othr>	
NCB Identification	<Id>DE11DCA000012345</Id>	
End of GenericAccountIdentification	</Othr>	
End Identification	</Id>	
CashAccountType	<Tp>	
RestrictionTypeCode	<Cd>SACC</Cd>	
End of CashAccountType	</Tp>	
EndCreditorAccount	</CdtrAcct>	M
Transferred Amount	<TrfdAmt>	M
AmountWithCurrency	<AmtWthCcy Ccy="EUR">1500.00</AmtWthCcy>	M
End of Transferred Amount	</TrfdAmt>	
Debtor	<Dbtr>	
DebtorAccount	<DbtrAcct>	M
Identification	<Id>	
GenericAccountIdentification	<Othr>	
NCB Identification	<Id>DE11RTGS0000123</Id>	
End of GenericAccountIdentification	</Othr>	
End Identification	</Id>	
BalanceTypeCode	<Tp>	
RestrictionTypeCode	<Cd>SACC</Cd>	
End of CashAccountType	</Tp>	
EndDebtorAccount	</DbtrAcct>	M
SettlementDate	<SttlmDt>2018-01-02</SttlmDt>	
End of LiquidityCreditTransfer1	</LqdyCdtTrf>	
End of LiquidityCreditTransfer1	</LqdyCdtTrf>	

6.14.4 Receipt

Cash Management Standard

Receipt_TIPSI

Scope: The Receipt is used in response to a LiquidityCreditTransfer message sent to TIPS. It is used to notify about rejections of LiquidityCreditTransfers having functional errors or to indicate successful settlement.

TIPSI always uses "camt.025.001.04" standard.

Structure:

message name receipt	<Rct>
Message Header	<MsgHdr>
Message Identification	<MsgId>-</MsgId>
CreationDateTime	<CreDtTm>-</CreDtTm>
End of Message Header	</MsgHdr>
Receipt details	<RctDtls>
original message ID	<OrgnMsgId>
Message Identification	<MsgId>-</MsgId>
End of Original Message ID	</OrgnMsgId>
RequestHandling	<ReqHdlg>
StatusCode	<StsCd>-</StsCd>
Description	<Desc>-</Desc>
End of Request Handling	</ReqHdlg>
End of Receipt details	</RctDtls>
End message name Receipt	</Rct>

Attributes:

name of attribute	format	short description	description
<Rct>		message name receipt Mandatory	Validation: [1..1]
<MsgHdr>		Message Header Mandatory	Set of characteristics specific to the message Validation: [1..1]
<MsgId>-</MsgId>	16x	Message Identification Mandatory	Point to point reference, as assigned by the sender, to unambiguously identify the message. Point to point reference, as assigned by the sender (TIPSI), to unambiguously identify the message. Validation: [1..1]
<CreDtTm>-</CreDtTm>	ISODateTim e	CreationDateTime Optional	Date and time when the message has been created. Validation: [0..1]
</MsgHdr>		End of Message Header Mandatory	Validation: [1..1]
<RctDtls>		Receipt details Mandatory	Validation: [1..1]
<OrgnMsgId>		original message ID Mandatory	Additional Reference Reference to the task, generated by SSP module Validation: [1..1]
<MsgId>-</MsgId>	35x	Message Identification Mandatory	Message Identification MessageID given by the original message (Document/LqdyCdtTrf/MsgHdr/MsgId), "NONREF" in case no MessageID is available. Validation: [1..1]
</OrgnMsgId>		End of Original Message ID Mandatory	End of Original Message ID Validation: [1..1]
<ReqHdlg>		RequestHandling Optional	RequestHandling Gives the status of the request. StatusCode Description Element includes status codes and related status descriptions. Validation: [0..1]
<StsCd>-</StsCd>	4!x	StatusCode Mandatory	XML status codes according T2 UDFS Status "0000" (X00 = O.k.) indicates successful execution of the LiquidityCreditTransfer. Validation:

name of attribute	format	short description	description
			[1..1]
<Desc></Desc>	140x	Description Optional	Specification of the error, in free format. Description related to T2 status code (taken from static data). Validation: [0..1]
</ReqHdlg>		End of Request Handling Optional	End of Request Handling Validation: [0..1]
</RctDtls>		End of Receipt details Mandatory	Validation: [1..1]
</Rct>		End message name Receipt Mandatory	Validation: [1..1]

Error Codes:

Receipt_TIPSI

Scope:

message name receipt	<Rct>
Message Header	<MsgHdr>
Message Identification	<MsgId>125879</MsgId>
CreationDateTime	<CreDtTm>2018-01-04T09:30:47</CreDtTm>
End of Message Header	</MsgHdr>
Receipt details	<RctDtIs>
original message ID	<OrgnlMsgId>
Message Identification	<MsgId>123654XYZ</MsgId>
End of Original Message ID	</OrgnlMsgId>
RequestHandling	<ReqHdlg>
StatusCode	<StsCd>0000</StsCd>
Description	<Desc>O.k.</Desc>
End of Request Handling	</ReqHdlg>
End of Receipt details	</RctDtIs>
End message name Receipt	</Rct>

6.14.5 ReturnAccount

Cash Management Standard

ReturnAccount_TIPSI

Scope: This is the response message of TIPS for a GetAccount request. It is expected to receive a TIPS account balance asked within the query.

The standard supported by TIPSI is "camt.004.001.07".

Structure:

Message Type	<RtrAcct>
Message Header	<MsgHdr>
Message Identification	<MsgId>-</MsgId>
CreationDateTime	<CreDtTm>-</CreDtTm>
Original Business Query	<OrgnlBizQry>
Message Identification	<MsgId>-</MsgId>
End of Original Business Query	</OrgnlBizQry>
End of Message Header	</MsgHdr>
StandingOrderOrErrorChoice	<RptOrErr>
AccountReport	<AcctRpt>
Account Identification	<AcctId>
GenericAccountIdentification	<Othr>
Identification	<Id>-</Id>
End of GenericAccountIdentification	</Othr>
End of Account Identification	</AcctId>
Account information (or business error)	<AcctOrErr>
Account Identification	<Acct>
Currency	<Ccy>-</Ccy>
Owner	<Ownr>
Identification	<Id>
OrganisationIdentification	<OrgId>
AnyBICIdentifier	<AnyBIC>-</AnyBIC>
End of OrganisationIdentification	</OrgId>
End Identification	</Id>
End of Owner	</Ownr>
MultilateralBalance	<MulBal>
Amount	<Amt>-</Amt>
Credit or debit indicator	<CdtDbtInd>-</CdtDbtInd>
Value Date	<ValDt>
Date Time	<DtTm>-</DtTm>
End of Value Date / Time	</ValDt>
RestrictionType	<RstrctnTp>
BalanceTypeCode	<Tp>
Identification	<Id>-</Id>
End of CashAccountType	</Tp>
Processing Type	<PrcgTp>
RestrictionTypeCode	<Cd>-</Cd>
End of Processing type	</PrcgTp>
End of RestrictionType	</RstrctnTp>
End of MultilateralBalance	</MulBal>
End of Account	</Acct>
End of Account or Business Error	</AcctOrErr>
End of AccountReport	</AcctRpt>
Operational Error	<OpriErr>

Error handling				<Err>
Proprietary error code				<Prtry>--</Prtry>
End error handling				</Err>
Description				<Desc>--</Desc>
End of Operational Error				</OpriErr>
End of BusinessDayReportOrErrorChoice				</RptOrErr>
End of Message Type				</RtrAcct>

Attributes:

name of attribute	format	short description	description
<RtrAcct>		Message Type Mandatory	Validation: [1..1]
<MsgHdr>		Message Header Mandatory	Set of characteristics specific to the message Validation: [1..1]
<MsgId>-</MsgId>	16x	Message Identification Mandatory	String of characters that uniquely identifies a message Unique identification generated by TIPS. Validation: [1..1]
<CreDtTm>-</CreDtTm>	ISODateTime	CreationDateTime Mandatory	Date and time when the message has been created. Date and Time when the message was created by T2 Validation: [1..1]
<OrgnlBizQry>		Original Business Query Mandatory	Original Business Query, reference to the query Validation: [1..1]
<MsgId>-</MsgId>	16x	Message Identification Mandatory	String of characters that uniquely identifies a message MessageIdentification of the related GetAccount request sent by the T2 participant. Validation: [1..1]
</OrgnlBizQry>		End of Original Business Query Mandatory	End of Original Business Query, reference to the query Validation: [1..1]
</MsgHdr>		End of Message Header Mandatory	Validation: [1..1]
<RptOrErr>		StandingOrderOrErrorChoice Mandatory	Validation: [1..1]
<AcctRpt>		AccountReport Mandatory	It is either returned the AccountReport or an OperationalError. AccountReport element including AccountIDs and related information. Validation: [1..1]
<AcctId>		Account Identification Mandatory	Account Identification Validation: [1..1]
<Othr>		GenericAccountIdentification Mandatory	GenericAccountIdentification Identification of the TIPS account the given details are related to. Validation: [1..1]

name of attribute	format	short description	description
<Id>-</Id>	34x	Identification Mandatory	Name or number assigned by an entity to enable recognition of that entity, eg, account identifier. Validation: [1..1]
</Othr>		End of GenericAccountIdentification Mandatory	End of GenericAccountIdentification Validation: [1..1]
</AcctId>		End of Account Identification Mandatory	 Validation: [1..1]
<AcctOrErr>		Account information (or business error) Mandatory	 Validation: [1..1]
<Acct>		Account Identification Mandatory	Account to or from which a cash entry is made Validation: [1..1]
<Ccy>-<Ccy>	3!a	Currency Optional	Fixed value "EUR". Only responses for EURO account queries expected. Validation: [0..1]
<Ownr>		Owner Optional	 Validation: [0..1]
<Id>		Identification Optional	Identification Unique and unambiguous identification for the account between the account owner and the account servicer. Validation: [0..1]
<OrgId>		OrganisationIdentification Mandatory	OrganisationIdentification Validation: [1..1]
<AnyBIC>-</AnyBIC>	4!a2!a2!c[3!cAnyBICIdentifier]	Mandatory	BIC of the TIPS account owner. Not used by T2 Validation: [1..1]
</OrgId>		End of OrganisationIdentification Mandatory	End of OrganisationIdentification Validation: [1..1]
</Id>		End Identification Optional	End of EntityIdentifier Validation: [0..1]
</Ownr>		End of Owner	

name of attribute	format	short description	description
		Optional	Validation: [0..1]
<MulBal>		MultilateralBalance	Balance is calculated with regard to many members in the system. Element including several balance details.
		Optional	Validation: [0..1]
<Amt>-</Amt>	15d	Amount	Amount (with implied currency) Unsigned balance amount value.
		Mandatory	Validation: [1..1]
<CdtDbtInd>-</CdtDbtInd>	4!a	Credit or debit indicator	CRDT = Credit Operation is an increase. DBIT = Debit Operation is a decrease. Indication whether balance value is positive or negative.
		Mandatory	Validation: [1..1]
<ValDt>		Value Date	
		Optional	Validation: [0..1]
<DtTm>-</DtTm>	ISODateTime	Date Time	Date and Time when the balance was calculated
		Mandatory	Validation: [1..1]
</ValDt>		End of Value Date / Time	
		Optional	Validation: [0..1]
<RstrctnTp>		RestrictionType	RestrictionType Optional element used in case of BalanceTypeCode = "RSTR". Optional element . Not used in T2
		Optional	Validation: [0..1]
<Tp>		BalanceTypeCode	
		Mandatory	Validation: [1..1]
<Id>-</Id>	35x	Identification	Identification String of characters that uniquely identifies a message. Identification assigned by an institution. Not used in T2
		Mandatory	Validation: [1..1]
</Tp>		End of CashAccountType	End of CashAccountType
		Mandatory	Validation: [1..1]
<PrcgTp>		Processing Type	Type providing further information on balance restriction

name of attribute	format	short description	description
		Optional	Validation: [0..1]
<Cd></Cd>	4!c	RestrictionTypeCode	RestrictionTypeCode T2S restriction type codes for Dedicated Cash Account Balance Query. - Possible values are: "BLCK" - Blocking "CSDB" - CoSDBlocking "EARM" - Earmarking "EFAC" - EarmarkingForAutoCollateralisation "RSVT" - Reservation TIPS restriction type codes Not used in T2
		Mandatory	Validation: [1..1]
</PrcgTp>		End of Processing type	End of type providing further information on balance restriction
		Optional	Validation: [0..1]
</RstrctnTp>		End of RestrictionType	End of RestrictionType Optional element used in case of BalanceTypeCode = "RSTR".
		Optional	Validation: [0..1]
</MulBal>		End of MultilateralBalance	End of MultilateralBalance
		Optional	Validation: [0..1]
</Acct>		End of Account	End of Account
		Mandatory	Validation: [1..1]
</AcctOrErr>		End of Account or Business Error	
		Mandatory	Validation: [1..1]
</AcctRpt>		End of AccountReport	End of AccountReport
		Mandatory	Validation: [1..1]
<OprlErr>		Operational Error	Error codes and related descriptions
		Mandatory	Validation: [1..1]
<Err>		Error handling	
		Mandatory	Validation: [1..1]
<Prtry></Prtry>	4x	Proprietary error code	Specification of the error, in free format. TIPS error reason code.
		Mandatory	Validation: [1..1]
</Err>		End error handling	

name of attribute	format	short description	description
		Mandatory	Validation: [1..1]
<Desc>-</Desc>	140x	Description	Specification of the error, in free format. TIPS description of the error reason.
		Optional	Validation: [0..1]
</OpriErr>		End of Operational Error	End of Operational Error
		Mandatory	Validation: [1..1]
</RptOrErr>		End of BusinessDayReportOrError Choice	
		Mandatory	Validation: [1..1]
</RtrAcct>		End of Message Type	
		Mandatory	Validation: [1..1]

Error Codes:

ReturnAccount_TIPS

Scope:

Message Type	<RtrAcct>
Message Header	<MsgHdr>
Message Identification	<MsgId>465987</MsgId>
CreationDateTime	<CreDtTm>2018-01-04T09:30:47</CreDtTm>
Original Business Query	<OrgnlBizQry>
Message Identification	<MsgId>144526</MsgId>
End of Original Business Query	</OrgnlBizQry>
End of Message Header	</MsgHdr>
StandingOrderOrErrorChoice	<RptOrErr>
AccountReport	<AcctRpt>
Account Identification	<AcctId>
GenericAccountIdentification	<Othr>
Identification	<Id>TIPSDEDICATEDCASHACCOUNT</Id>
End of GenericAccountIdentification	</Othr>
End of Account Identification	</AcctId>
Account information (or business error)	<AcctOrErr>
Account Identification	<Acct>
Currency	<Ccy>EUR</Ccy>
Owner	<Ownr>
Identification	<Id>
OrganisationIdentification	<OrgId>
AnyBICIdentifier	<AnyBIC>AAAAAAA</AnyBIC>
End of OrganisationIdentification	</OrgId>
End Identification	</Id>
End of Owner	</Ownr>
MultilateralBalance	<MulBal>
Amount	<Amt>1000.00</Amt>
Credit or debit indicator	<CdtDbtInd>DBIT</CdtDbtInd>
Value Date	<ValDt>
Date Time	<DtTm>2018-01-04T09:30:47</DtTm>
End of Value Date / Time	</ValDt>
RestrictionType	<RstrctnTp>
BalanceTypeCode	<Tp>
Identification	<Id>12365448</Id>
End of CashAccountType	</Tp>
Processing Type	<PrcgTp>
RestrictionTypeCode	<Cd>BLCK</Cd>
End of Processing type	</PrcgTp>
End of RestrictionType	</RstrctnTp>
End of MultilateralBalance	</MulBal>
End of Account	</Acct>
End of Account or Business Error	</AcctOrErr>
End of AccountReport	</AcctRpt>
Operational Error	<OpriErr>
Error handling	<Err>
Proprietary error code	<Prtry>0000</Prtry>
End error handling	</Err>
Description	<Desc>O.k.</Desc>
End of Operational Error	</OpriErr>

End of BusinessDayReportOrErrorChoice
End of Message Type

| </RptOrErr>
</RtrAcct>

6.14.6 General Ledger for TIPS (for CBs only)

Cash Management Standard

General Ledger for TIPS_TIPSI

Scope: The General Ledger File is created during the EoD-process and provided to the CBs via camt.053 message. This camt.053 message is generated for each single CB containing the data exclusively for this CB and sent to the DN of the CB extracted from static data

Structure:

BankToCustomerStatement	<BkToCstmrStmt>	
GroupHeader	<GrpHdr>	
Message Identification	<MsgId>-</MsgId>	
CreationDateTime	<CreDtTm>-</CreDtTm>	
EndGroupHeader	</GrpHdr>	
Information for an account statement report	<Stmt>	
Message business identification	<Id>-</Id>	
CreationDateTime	<CreDtTm>-</CreDtTm>	
Account Identification	<Acct>	
Identification	<Id>	
GenericAccountIdentification	<Othr>	
NCB Identification	<Id>-</Id>	M
End of GenericAccountIdentification	</Othr>	
End Identification	</Id>	
Owner	<Ownr>	
Identification	<Id>	
OrganisationIdentification	<OrgId>	
AnyBICIdentifier	<AnyBIC>-</AnyBIC>	
End of OrganisationIdentification	</OrgId>	
End Identification	</Id>	
Country of Residence	<CrtyOfRes>-</CrtyOfRes>	M
End of Owner	</Ownr>	
End of Account	</Acct>	
Balance	<Bal>	
Balance Type choice	<Tp>	
BalanceType	<CdOrPrtry>	
BalanceTypeCode	<Cd>-</Cd>	M
End of BalanceType	</CdOrPrtry>	M
End of SystemEventTypeChoice	</Tp>	
Amount	<Amt Ccy="EUR">-</Amt>	
Credit or debit indicator	<CdtDbtInd>-</CdtDbtInd>	M
Date	<Dt>	
Date	<Dt>-</Dt>	
End of Date	</Dt>	
End of Balance	</Bal>	
Balance	<Bal>	
Balance Type choice	<Tp>	
BalanceType	<CdOrPrtry>	M
BalanceTypeCode	<Cd>-</Cd>	M
End of BalanceType	</CdOrPrty>	
End of SystemEventTypeChoice	</Tp>	
Amount	<Amt Ccy="EUR">-</Amt>	
Credit or debit indicator	<CdtDbtInd>-</CdtDbtInd>	M
Date	<Dt>	

Date				<Dt></Dt>
End of Date				</Dt>
End Balance				</Bal>
TotalTransactions				<TxSummary>
NumberAndSumOfTransactions				<TtlCdtNtries>
Sum of credit transactions for the reported TIPS account				<Sum></Sum>
End of NumberAndSumOfTransactions				</TtlCdtNtries>
NumberAndSumOfTransactions				<TtlDbtNtries>
Sum of debit transactions for the reported TIPS account				<Sum></Sum>
End of NumberAndSumOfTransactions				</TtlDbtNtries>
End of TotalTransactions				</TxSummary>
End of Information for an account statement report.				</Stmnt>
End of BankToCustomerStatement				</BkToCstmrStmnt>

Attributes:

name of attribute	format	short description	description
<BkToCstmrStmnt>		BankToCustomerStatement Mandatory	Validation: [1..1]
<GrpHdr>		GroupHeader Mandatory	Validation: [1..1]
<MsgId>-</MsgId>	16x	Message Identification Mandatory	Point to point reference, as assigned by the sender, to unambiguously identify the message. Validation: [1..1]
<CreDtTm>-</CreDtTm>	ISODateTime	CreationDateTime Mandatory	Date and time when the message has been created. Validation: [1..1]
</GrpHdr>		EndGroupHeader Mandatory	Validation: [1..1]
<Stmnt>		Information for an account statement report Mandatory	Information for an account statement report. Validation: [1..n]
<Id>-</Id>	16x	Message business identification Mandatory	String of characters that uniquely identifies a message at senders side. Unique and unambiguous identifier for a message, as assigned by the Sender. This unique identifier can be used for cross-referencing purposes in subsequent messages. Validation: [1..1]
<CreDtTm>-</CreDtTm>	ISODateTime	CreationDateTime Mandatory	Date and time when the message has been created. Validation: [1..1]
<Acct>		Account Identification Mandatory	Validation: [1..1]
<Id>		Identification Mandatory	Identification Validation: [1..1]
<Othr>		GenericAccountIdentification Mandatory	GenericAccountIdentification Validation: [1..1]
<Id>-</Id>	34x	NCB Identification Mandatory	TIPS account number of the billed direct participant Validation: [1..1]



name of attribute	format	short description	description
</Othr>		End of GenericAccountIdentification Mandatory	End of GenericAccountIdentification Validation: [1..1]
</ld>		End Identification Mandatory	End Identification Validation: [1..1]
<Ownr>		Owner Optional	Validation: [0..1]
<ld>		Identification Optional	Validation: [0..1]
<Orgld>		OrganisationIdentification Mandatory	OrganisationIdentification Validation: [1..1]
<AnyBIC>-</AnyBIC>	4!a2!a2!c[3! c]	AnyBICIdentifier Optional	AnyBICIdentifier / BIC used on behalf of third parties Validation: [0..1]
</Orgld>		End of OrganisationIdentification Mandatory	End of OrganisationIdentification Validation: [1..1]
</ld>		End Identification Optional	End Identification Validation: [0..1]
<CrtyOfRes>-</CrtyOfRes>		Country of Residence Optional	Country Code of the CB Validation: [0..1]
</Ownr>		End of Owner Optional	Validation: [0..1]
</Acct>		End of Account Mandatory	End of Account Validation: [1..1]
<Bal>		Balance Mandatory	Validation: [1..n]
<Tp>		Balance Type choice Mandatory	Validation: [1..1]
<CdOrPrtry>		BalanceType	BalanceType

name of attribute	format	short description	description	
		Mandatory	Validation: [1..1]	
<Cd>-</Cd>		BalanceTypeCode Mandatory	Specifies the nature of the balance OPBD=opening of the businessday Validation: [1..1]	M
</CdOrPrtry>		End of BalanceType Mandatory	End of BalanceType Validation: [1..1]	M
</Tp>		End of SystemEventTypeChoice Mandatory	Validation: [1..1]	
<Amt Ccy="EUR">-</Amt>	15d	Amount Mandatory	Amount in EURO Validation: [1..1]	
<CdtDbtInd>-</CdtDbtInd>	4!a	Credit or debit indicator Mandatory	Validation: [1..1]	M
<Dt>		Date Mandatory	Date and time choice Validation: [1..1]	
<Dt>-</Dt>	ISO-Date	Date Mandatory	Date within a particular calendar year represented by YYYY-MM-DD (ISO 8601). Validation: [1..1]	
</Dt>		End of Date Mandatory	Validation: [1..1]	
</Bal>		End of Balance Mandatory	End of Balance Validation: [1..n]	
<Bal>		Balance Mandatory	Validation: [1..n]	
<Tp>		Balance Type choice Mandatory	Validation: [1..1]	
<CdOrPrtry>		BalanceType Mandatory	BalanceType Validation: [1..1]	M
<Cd>-</Cd>		BalanceTypeCode Mandatory	Specifies the nature of the balance CLBD=closing of the businessday Validation:	M

name of attribute	format	short description	description	
			[1..1]	
</CdOrPrtry>		End of BalanceType Mandatory	End of BalanceType Validation: [1..1]	M
</Tp>		End of SystemEventTypeChoice Mandatory	Validation: [1..1]	
<Amt Ccy="EUR"></Amt>	15d	Amount Mandatory	Amount in EURO Validation: [1..1]	
<CdtDbtInd></CdtDbtInd>	4!a	Credit or debit indicator Mandatory	Validation: [1..1]	M
<Dt>		Date Mandatory	Date and time choice Validation: [1..1]	
<Dt></Dt>	ISODate	Date Mandatory	Date within a particular calendar year represented by YYYY-MM-DD (ISO 8601). Validation: [1..1]	
</Dt>		End of Date Mandatory	Validation: [1..1]	
</Bal>		End Balance Mandatory	Validation: [1..n]	
<TxsSummary>		TotalTransactions Optional	TotalTransactions TotalTransactions Validation: [0..1]	
<TtlCdtNtries>		NumberAndSumOfTransactions Optional	NumberAndSumOfTransactions Validation: [0..1]	
<Sum></Sum>		Sum of credit transactions for the reported TIPS account Optional	Sum of credit transactions for the reported TIPS account Validation: [0..1]	
</TtlCdtNtries>		End of NumberAndSumOfTransactions Optional	End of NumberAndSumOfTransactions Validation: [0..1]	
<TtlDbtNtries>		NumberAndSumOfTransactions	NumberAndSumOfTransactions	

name of attribute	format	short description	description
		Optional	Validation: [0..1]
<Sum></Sum>		Sum of debit transactions for the reported TIPS account Optional	Sum of debit transactions for the reported TIPS account Validation: [0..1]
</TtlDbtNtries>		End of NumberAndSumOfTransactions Optional	End of NumberAndSumOfTransactions Validation: [0..1]
</TxSummary>		End of TotalTransactions Optional	End of TotalTransactions Validation: [0..1]
</Stmnt>		End of Information for an account statement report. Mandatory	Validation: [1..1]
</BkToCstmrStmnt>		End of BankToCustomerStatement Mandatory	Validation: [1..1]

Error Codes:

General Ledger TIPS

Scope:

BankToCustomerStatement	<BkToCstmrStmnt>	
GroupHeader	<GrpHdr>	
Message Identification	<MsgId>1234567890</MsgId>	
CreationDateTime	<CreDtTm>2018-08-27T15:05:03.316+02:00</CreDtTm>	M
EndGroupHeader	</GrpHdr>	
Information for an account statement report	<Stmnt>	
Message business identification	<Id>T2TIPS20181217</Id>	
CreationDateTime	<CreDtTm>2018-08-27T15:05:03.316+02:00</CreDtTm>	M
Account Identification	<Acct>	
Identification	<Id>	
GenericAccountIdentification	<Othr>	
NCB Identification	<Id>TIPSACC0123456789EUR</Id>	M
End of GenericAccountIdentification	</Othr>	
End Identification	</Id>	
Owner	<Ownr>	
Identification	<Id>	
OrganisationIdentification	<OrgId>	
AnyBICIdentifier	<AnyBIC>AAAAE20</AnyBIC>	
End of OrganisationIdentification	</OrgId>	
End Identification	</Id>	
Country of Residence	<CtryOfRes>DE</CtryOfRes>	
End of Owner	</Ownr>	
End of Account	</Acct>	
Balance	<Bal>	
Balance Type choice	<Tp>	
BalanceType	<CdOrPrtry>	
BalanceTypeCode	<Cd>OPBD</Cd>	
End of BalanceType	</CdOrPrtry>	
End of SystemEventTypeChoice	</Tp>	
Amount	<Amt Ccy="EUR">0</Amt>	
Credit or debit indicator	<CdtDbtInd>DBIT</CdtDbtInd>	
Date	<Dt>	
Date	<Dt>2018-12-17</Dt>	
End of Date	</Dt>	
End of Balance	</Bal>	
Balance	<Bal>	
Balance Type choice	<Tp>	
BalanceType	<CdOrPrtry>	
BalanceTypeCode	<Cd>CLBD</Cd>	
End of BalanceType	</CdOrPrtry>	
End of SystemEventTypeChoice	</Tp>	
Amount	<Amt Ccy="EUR">0</Amt>	
Credit or debit indicator	<CdtDbtInd>DBIT</CdtDbtInd>	
Date	<Dt>	
Date	<Dt>2018-12-17</Dt>	
End of Date	</Dt>	
End Balance	</Bal>	
TotalTransactions	<TxsSummry>	
NumberAndSumOfTransactions	<TtlCdtNtries>	

Sum of credit transactions for the reported TIPS account		<Sum>0</Sum>
End of NumberAndSumOfTransactions		</TtlCdtNtries>
NumberAndSumOfTransactions		<TtlDbtNtries>
Sum of debit transactions for the reported TIPS account		<Sum>0</Sum>
End of NumberAndSumOfTransactions		</TtlDbtNtries>
End of TotalTransactions		</TxsSummry>
End of Information for an account statement report.		</Stmt>
End of BankToCustomerStatement		</BkToCstmrStmt>

7 Annexes

7.1 Annex 1: XML messages and user roles

The annex 1 gives a detailed overview of the different XML messages and the user roles allowed to use them:

Category	message type	APPLICATE for CI	APPLICBTE for CB	APPLIASTE for AS	APPLICDTE for T2S Actors in TARGET2	Remark Regarding the handling in ICM
Common messages						
GetBroadcast	ssp proprietary	X	X	X		
GetPendingData	ssp proprietary					no role validation
GetRawData	ssp proprietary		X			
GetSystemTime	ssp proprietary					no role validation
GetTask	ssp proprietary	X	X	X		no task queues for ASI and T2SI messages available
PM messages						
BackupPayment	SWIFT standard	X	X			
BackupPayment	ssp proprietary		X			only for CB's
CancelTransaction	SWIFT standard	X	X			
DeleteLimit	SWIFT standard	X	X			
DeleteReservation	SWIFT standard	X	X			
GetAccount	SWIFT standard	X	X			
GetBusinessDayInformation	SWIFT standard	X	X	X		
GetCreditLine	ssp proprietary	X	X			
GetLimit	SWIFT standard	X	X			
GetReservation	SWIFT standard	X	X			
GetSequence	ssp proprietary	X	X			
GetSettlementInformation	ssp proprietary		X			
GetTransaction	SWIFT standard	X	X	X		
LiquidityCreditTransfer	SWIFT standard	X	X			
ModifyCreditLine	ssp proprietary		X			
ModifyLimit	SWIFT standard	X	X			
ModifyReservation	SWIFT standard	X	X			
ModifySequence	ssp proprietary	X	X			
ModifyTransaction	SWIFT standard	X	X			
ReleasePayment	ssp proprietary		X			
SD messages						

Category	message type	APPLICATE for CI	APPLICBTE for CB	APPLIASTE for AS	APPLICDTE for T2S Actors in TARGET2	Remark Regarding the handling in ICM
DeleteHAMAccount	ssp proprietary		X			
DeleteRTGSAccount	ssp proprietary		X			
DeleteSFAccount	ssp proprietary		X			
DeleteSubAccount	ssp proprietary		X			
GetAS	ssp proprietary	X	X	X		
GetASSettBank	ssp proprietary	X	X	X		
GetCalendar	ssp proprietary	X	X	X		
GetCB	ssp proprietary	X	X	X		
GetContactItem	ssp proprietary	X	X	X		
GetDirectDebit	ssp proprietary	X	X			
GetErrorCode	ssp proprietary	X	X	X		
GetEvent	ssp proprietary	X	X	X		
GetGOA	ssp proprietary	X	X			
GetHAMAccount	ssp proprietary	X	X			
GetLegalEntity	ssp proprietary	X	X	X		
GetParticipant	ssp proprietary	X	X	X		
GetRTGSAccount	ssp proprietary	X	X	X		
GetSFAccount	ssp proprietary	X	X			
GetSubAccount	ssp proprietary	X	X	X		
GetStandingOrderMirror	ssp proprietary	X	X	X		
GetStandingOrderSub	ssp proprietary	X	X			
GetStandingOrderDCA	SWIFT standard	X	X			
GetT2Wildcard	ssp proprietary	X	X			
ModifyHAMAccount	ssp proprietary		X			
ModifyLimit	SWIFT standard	X	X			
ModifyReservation	SWIFT standard	X	X			
ModifyRTGSAccount	ssp proprietary		X			
ModifySFAccount	ssp proprietary		X			
ModifyStandingOrder	SWIFT standard	X	X			
ModifyStandingOrderDCA	SWIFT standard	X	X			
ModifyStandingOrderMirror	ssp proprietary	X	X			
ModifySubAccount	ssp proprietary		X			
ASI messages						
SBTransferInitiation	ssp proprietary	X	X	X		

Category	message type	APPLICATE for CI	APPLICBTE for CB	APPLIASTE for AS	APPLICDTE for T2S Actors in TARGET2	Remark Regarding the handling in ICM
ASInitiationStatus	ssp proprietary					
ASTransferInitiation	ssp proprietary					
ASTransferNotice	ssp proprietary					
T2SI messages						
CancelTransaction	SWIFT standard					These messages are not processed by ICM but role request control is done by T2SI.
GetAccount	SWIFT standard	X	X		X	
GetTransaction	SWIFT standard				X	
LiquidityCreditTransfer	SWIFT standard				X	
HAM messages						
CancelTransaction	SWIFT standard		X			
GetAccount	SWIFT standard	X	X			
GetBusinessDayInformation	SWIFT standard	X	X			
GetReservation	SWIFT standard	X	X			
GetThreshold	ssp proprietary		X			
GetTransaction	SWIFT standard	X	X			
LiquidityCreditTransfer	SWIFT standard	X	X			
ModifyReservation	SWIFT standard	X	X			
ModifyStandingOrder	SWIFT standard	X	X			
ModifyTransaction	SWIFT standard		X			
ReleasePayment	ssp proprietary		X			
SF messages						
GetAccount	SWIFT standard	X	X			
GetTransaction	SWIFT standard	X	X			
LiquidityCreditTransfer	SWIFT standard	X	X			
RM messages						
AuthorizePenalty	ssp proprietary		X			
GetAccount	SWIFT standard	X	X			
GetCompulsoryReserve	ssp proprietary		X			
GetPenalty	ssp proprietary		X			
InsertCompulsoryReserve	ssp proprietary		X			
InsertPHABalance	ssp proprietary		X			
CM messages						
GetAccount	SWIFT standard					
GetBusinessDayInformation	SWIFT standard					
GetTransaction	SWIFT standard					
LiquidityCreditTransfer	SWIFT standard					

Category	message type	APPLICATE for CI	APPLICBTE for CB	APPLIASTE for AS	APPLICDTE for T2S Actors in TARGET2	Remark Regarding the handling in ICM
PHA messages						
GetAccount	SWIFT standard	X	X			
GetCreditLine	ssp proprietary	X	X			
LiquidityCreditTransfer	SWIFT standard	X	X			
ModifyStandingOrder	SWIFT standard	X	X			

7.2 Annex 2: Connection to ICM – Requirements for Proprietary Home Accounting Applications (PHA)

(Relevant for CBs only)

Content

A)	Scope and addressees.....	7
B)	Communication infrastructure requirements.....	8
B.a)	Client-server interaction - graphical overview.....	8
B.b)	A2A approach.....	9
B.c)	SWIFT SIPN.....	9
B.c.a)	Connectivity requirements.....	9
B.c.b)	Client-server model requirements.....	9
B.c.c)	Security requirements.....	10
B.c.c.a)	Highly privileged access of ICM to PHA.....	10
B.c.c.b)	Non-repudiation of emission (NRE).....	10
B.c.d)	Usage of SWIFTNet InterAct.....	10
B.c.e)	SWIFT billing and pricing.....	10
C)	Application specification.....	11
C.a)	Collaboration protocol.....	11
C.a.a)	General remarks.....	11
C.a.b)	Pull mode (Real Time Protocol).....	11
C.a.c)	Task queue at PHA side.....	11
C.a.c.a)	Overview.....	11
C.a.c.b)	Status of tasks.....	12
C.a.c.c)	Processing of tasks.....	12
C.a.d)	Maximum response times of PHA.....	13
C.b)	ICM use cases for PHA.....	13
C.b.a)	General remarks.....	13
C.b.b)	Issue account information.....	13
C.b.c)	Issue credit line information.....	14
C.b.d)	Transfer liquidity.....	14
C.b.e)	Define/change standing order.....	14
C.b.f)	Issue system time.....	15
C.b.g)	Issue task queue information.....	15
C.b.h)	Create a task according to the four eyes principle.....	15
C.b.i)	Confirm a task.....	16
C.b.j)	Revoke a task.....	16
C.c)	Structure of XML messages.....	16
C.c.a)	General remarks.....	16
C.c.b)	Application Header.....	17
C.c.c)	Document.....	17
C.c.c.a)	General remarks.....	17
C.c.c.b)	Account.....	17
C.c.c.c)	CreditLine.....	17
C.c.c.d)	LiquidityCreditTransfer.....	17
C.c.c.e)	ModifyStandingOrder.....	18
C.c.c.f)	GetSystemTime.....	18
C.c.c.g)	GetTask.....	18
C.c.c.h)	ConfirmTask.....	18
C.c.c.i)	RevokeTask.....	18

C.d)	Handling of Errors.....	18
C.e)	SWIFTNet FIN.....	19
C.e.a)	General remarks	19
C.e.b)	Message Type (MT) 202.....	19
D)	Excursus: Insertion of PHA balances in the Reserve Management (RM) module	19
D.a)	Business case	19
D.b)	Communication infrastructure requirements.....	20
D.b.a)	Client-server interaction - graphical overview.....	20
D.b.b)	A2A approach	21
D.b.c)	SWIFT SIPN.....	21
D.b.c.a)	Connectivity requirements	21
D.b.c.b)	Client-server model requirements	21
D.b.c.c)	Security requirements.....	21
D.b.c.c.a)	Authorised access of ICM to PHA	21
D.b.c.c.b)	Non-repudiation of emission (NRE)	21
D.b.c.c.c)	Usage of SWIFTNet InterAct.....	21
D.b.c.c.d)	SWIFT billing and pricing	21
D.c)	Application specification	21
D.c.a)	Collaboration protocol	21
D.c.b)	Pull mode (Real Time Protocol)	21
D.c.c)	No task queue at ICM side.....	22
D.c.d)	No Maximum response times of PHA	22
D.c.e)	Use case: Insertion of PHA balance in RM	22
D.c.f)	Structure of XML message InsertPHABalance.....	22
E)	Further organisational and operational requirements for PHA.....	22
E.a)	Testing.....	22
E.b)	Quality insurance	23
E.c)	Support	23
E.d)	Availability.....	23
E.e)	Recovery time.....	23

A) Scope and addressees

The core services of TARGET2 include a so called Information and Control Module (ICM) which can be used to

- request information out of SSP and
- perform certain actions/control measures concerning the SSP modules.

For the national banking communities participating in TARGET2, the ICM therefore is an important tool to manage their business in TARGET2. If a CB continues to use its proprietary home accounting system (PHA) for keeping liquidity and liquidity supply for TARGET2, it has the possibility to use the following facilities in order to provide the credit institutions with a comprehensive view through the ICM on their liquidity in PHA, PM, HAM:

- Get information on its PHA account
- Initiate liquidity transfers between PHA and TARGET2 (current order as well as standing order) for the liquidity supply of RTGS accounts at the start of and during the business day.

To fulfil these business needs, the CBs participating in TARGET2 have the opportunity to connect their PHA with TARGET2 via the Information and Control Module (ICM). As already decided, it is up to the respective CB to decide whether it will implement or not the interface to the ICM.

This document aims at presenting the specifications for a connection of the PHAs to the ICM. Concerning SWIFTNet FIN, it is understood that the communication infrastructure already exists on PHA side (also see chapter C.e)).

Addressees of this document are functional and technical staffs responsible for the management of PHA systems in the CBs.

B) Communication infrastructure requirements

B.a) Client-server interaction - graphical overview

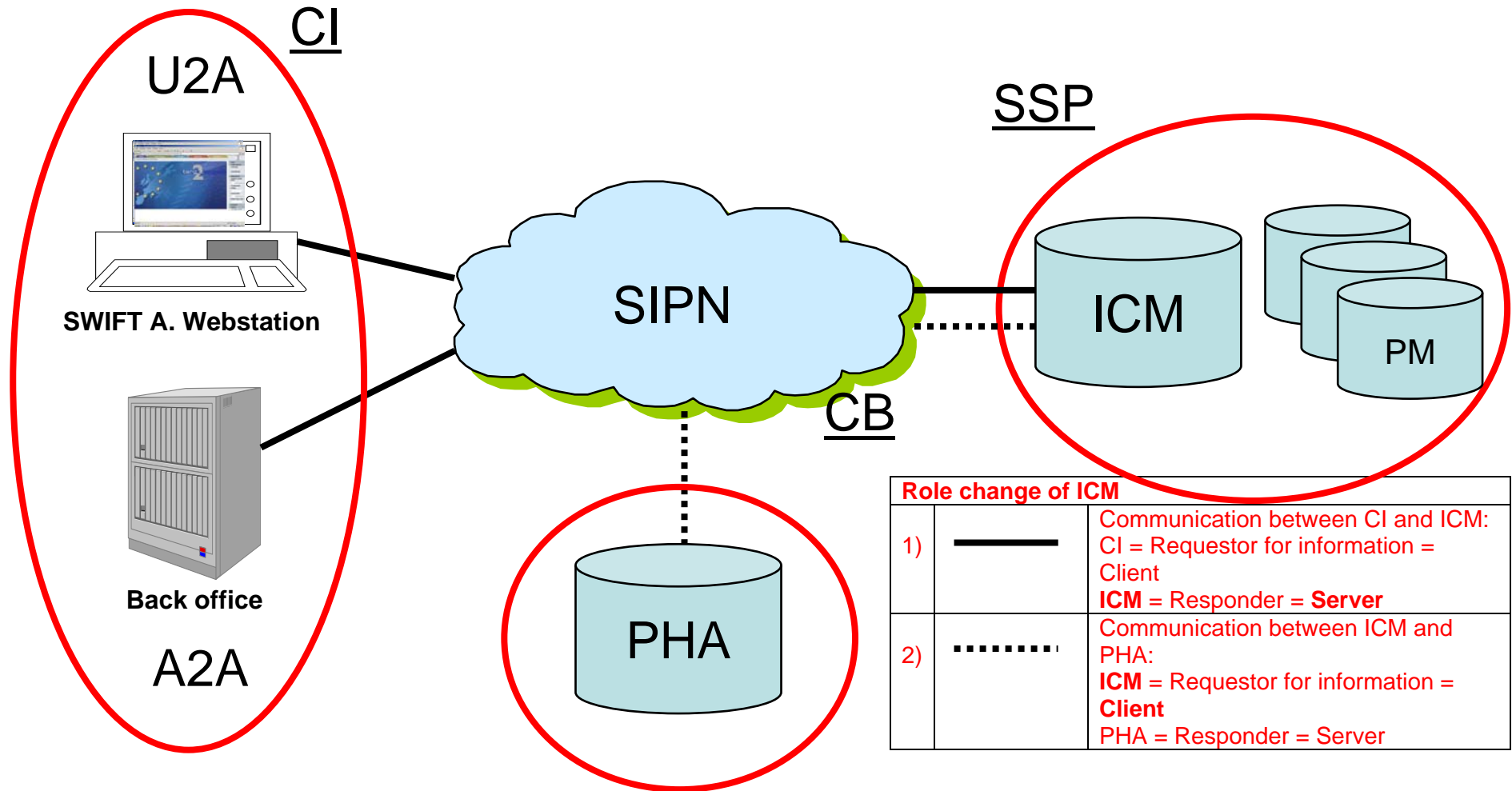

B.b) A2A approach

In order to exchange messages with the PHA and to display PHA information via the ICM, a communication infrastructure between ICM and PHA according to the A2A approach is required; i.e.:

- The network connection used is the Secure IP Network (SIPN) by SWIFT (see chapter B.c)).
- The communication supporting the use cases (see chapter C.b)) is then realized via XML messages (see chapter C.c)).
- The SWIFT service used is SWIFTNet InterAct (see chapter B.c.d)).

The same approach is used for all kind of interaction between the ICM and the PHA, irrespective of whether the initial client request was performed in U2A or in A2A mode.

B.c) SWIFT SIPN

B.c.a) Connectivity requirements

To be able to connect to the SWIFTNet, the PHA requires:

- a network connection to SWIFT SIPN,
- SWIFTNet Link and
- an interface.

It is expected because of security reasons that the internal network at CB level requires

- a firewall, that separates the internal traffic from the SWIFTNet and
- appropriate hardware components (router or switch) to integrate the SWIFTNet components in a DMZ¹.

For further connectivity requirements concerning the SWIFT SIPN, please refer to www.swift.com.

B.c.b) Client-server model requirements

PHA is considered as a SWIFT service provided by the CBs. The service to be used for production is **trgt.papss**. It is **not allowed** that the customer (CB using a PHA) registers a separate service.

According to the model of the client-server interaction (see chapter B.a)):

- ICM is the (only) client (requestor) for PHA. ICM sends requests/tasks to the PHA based on messages received from direct PM participants.
- PHA is the server (responder) for ICM. After processing the requests received from ICM it returns the respective results to ICM. Then ICM will return the 'answer' to the user.

The SWIFTNet server required on PHA side has to carry out the following tasks:

- Connection to the SWIFTNet
- Functional validation (e.g. existence of the respective account)
- Acceptance and parsing of the incoming XML requests
- Execution of the query on the legacy application database
- Dealing with the security features of SWIFTNet
- Generation of the XML response compliant with TARGET2 schema files (based on SWIFT cash management standard)

¹ Demilitarised zone – small network inserted as a "neutral zone" between the company's private network and the outside public network.

- Matching the user's distinguished name (=DN) to his BIC

The SWIFTNet server is an individual software application that the CB responsible for the PHA must implement and operate. The CB responsible for the PHA is fully responsible for the SWIFTNet server application.

To ensure the correct routing and handling of requests from the ICM to the PHA, the CB responsible for the PHA must take the necessary measures in the respective registration form for TARGET2, e.g. insert the DN of the PHA.

B.c.c) Security requirements

B.c.c.a) Highly privileged access of ICM to PHA

ICM is allowed to act on behalf of direct PM participants vis-à-vis the PHA, i.e. the ICM can request information about the proprietary home account of a direct PM participant and initiate control measures. Therefore, appropriate security measures have to be implemented at application-level by the CB (area of responsibility of each CB) in order to ensure that the ICM server with its specific DN has highly privileged access to the data of the respective PHA and that any unauthorized access will be rejected. Due to the general architecture of TARGET2, the creation and usage of SWIFT Closed User Groups (CUGs) and Role Based Access Control (RBAC) especially dedicated to the SWIFT communication between the ICM and the PHA is not supported by TARGET2. TARGET2 is the centralised service the PHAs may be connected to.

B.c.c.b) Non-repudiation of emission (NRE)

The SWIFT service NRE proves the exchange of files between the requestor and the responder. For an undoubted confirmation that a request is sent by a certain SWIFTNet client, SWIFT can store the request and its parameters. NRE must be applied in all cases of tasks² (i.e. writing access) sent from ICM to PHA. PHA has to reject a request if NRE is expected but not applied. The rules when NRE is recommended will be determined by TARGET2 (see chapter C.b)). The rules are the same as for the communication between TARGET2 users and ICM.

B.c.d) Usage of SWIFTNet InterAct

For the exchange of messages via the SWIFT SIPN the SWIFTNet service InterAct will be applied. Since the data volumes are rather small, it is expected, that the SWIFTNet service FileAct will not be applied.

B.c.e) SWIFT billing and pricing

In terms of billing, TARGET2 is designed with reverse billing option (participants pay), so whatever is sent to TARGET2 by a participant or sent by TARGET2 to a participant will be charged to the participant.

From this results, that the CBs responsible for the PHA must be aware that they are extra charged by SWIFT for the SWIFTNet services and features mentioned in this document. For details see the document "SWIFTNet Pricing & Invoicing" (incl. Service Administrator Fees).

² Differentiation between requests and tasks: requests for modification (Modify, Cancel and similar XML messages) are called "tasks".

C) Application specification

C.a) Collaboration protocol

C.a.a) General remarks

The protocol between ICM and PHA follows the protocol that is arranged between the protocol for the A2A users and ICM (see UDFS, book 4, chapter 2.1) but is simplified in some issues:

- Timeout management: regarding the SWIFTNet timeout for SWIFTNet InterAct requests the maximum time for ICM-PHA communication is 60 seconds. The maximum time for the “loop” (see chapter C.a.d)) is shorter. That means: If 60 seconds (less a reduction for the time needed for (1) the communication between the User and ICM, (2) the processing within the ICM and (3) the communication between the ICM and the PHA) are exceeded within the “loop” the response from PHA will never reach the user.
- Data compression: Since the messages are rather small, they will not be compressed.
- Bulk data: The maximum amount of data that can be transported with one SWIFTNet InterAct response is lower than 100.000 Bytes. There is no processing of messages larger than this size foreseen because it will not be needed.
- Task queue
The task queue must only be implemented on PHA side for the support of the four eyes principle and for the user’s requirement of having transparency on the tasks they performed during the business day (e.g. for audit purposes). To revise all tasks that are executed, it must be possible to download the tasks and their complete parameters. The task queue mechanism will be described in more detail in chapter C.a.c).

C.a.b) Pull mode (Real Time Protocol)

The protocol applied between ICM and PHA implies the so called pull mode, i.e. the transfer of messages from PHA to the ICM is initiated on request of the ICM (see client-server model, chapter B.a)). PHA processes the requests/tasks sent by the ICM. Requests/tasks will synchronously be answered with a response. Due to the small data volume it is expected that the responses are always messages and never files.

C.a.c) Task queue at PHA side

C.a.c.a) Overview

The ICM receives tasks concerning PHA from users with DNs completed by specific TARGET2 user roles. In the SWIFT communication between the users and the ICM, these user roles have been attached to the requests during the SWIFT processing by RBAC, a SWIFT service for user administration. Tasks can be sent by users with user roles according to the two eyes principle or the four eyes principle³. ICM distinguishes the tasks according to the two eyes principle or the four eyes principle. Then a new task is sent by ICM to the PHA. Amongst others, the application header of the related XML message (see UDFS, book 4, chapter 6.2) contains

- the original DN of the TARGET2 user and
- the application of the two eyes principle or four eyes principle.

As mentioned in chapter B.c.c.a), the usage of the SWIFT service RBAC is not necessary in the SWIFT communication between the ICM and the PHA.

To ensure an appropriate handling of the tasks sent by ICM, PHA must be able to

³ A task in two eyes principle immediately takes effect on the processing. Unlike this, four eyes principle means that a task must be confirmed by a second user before it will be executed.

- store the respective tasks in a separate structure (e.g. database table) called “task queue”,
- assign a changing status to the respective tasks,
- return a receipt stating the queue entry ID (unique ID given by PHA), the system time and a technical status code,
- process the respective tasks step by step and
- allow queries concerning tasks sent through ICM (initiated by users)

C.a.c.b) Status of tasks

In order to assign the respective changing status to the tasks, PHA has to implement the following changing status to be attached to the response of PHA:

Status	Description	Transition possible to
To confirm	The task must be confirmed by a second user and will not be processed.	Waiting, revoked, rejected
Waiting	The task can be processed.	Processing
Processing	The task is processed at the moment.	Rejected, completed
Revoked	The task has been revoked by a user.	
Rejected	An error was detected.	
Completed	The task was processed successfully.	

C.a.c.c) Processing of tasks

The following aspects must be considered by PHA for the processing of tasks:

- Receipt by PHA:

All tasks for PHA sent by ICM must be stored in a specific task queue of PHA. Since a request can contain only one modification, exactly one task is created per request. For the task a receipt message must be returned by PHA to ICM, which will be forwarded to the user. The receipt message must contain the queue entry ID, the system time and a technical status code. A positive receipt message indicates that there are no technical problems at the PHA and the respective request is accepted.

- Two eyes principle and four eyes principle:

If a new task is inserted in a task queue and has to be handled in “two eyes principle”, the task must be immediately assigned the status “waiting”. If a new task is inserted in a task queue and has to be handled in “four eyes principle”, the task must be assigned the status “to confirm”. The status “to confirm” indicates that this request will not be processed and has to be confirmed by a second user of the same institution. In this case, that means, that PHA requires a second task sent by ICM indicating the confirmation of the second user. I.e. the related XML message sent by ICM must have an application header (XML element “Dup/Info”) containing a DN different from the one indicated in the application header of the first XML message. If the respective task is confirmed, the status must be set to “waiting”, like tasks to be handled in two eyes principle. Tasks with status “to confirm” can also be revoked (both, the user who captured the task and a second authorised user). If this is the case, the respective tasks must be assigned the status “revoked”.

- Processing of tasks with status “waiting”:

The status “waiting” indicates, that the request can be processed. PHA must constantly scan its task queue for tasks in status “waiting”. If a new task is detected, the status of the task must be set to “processing” and the task must be processed. If a business error is detected during the processing, the status of the task must be set to “rejected”. If the task was processed successfully, the status must be set to “completed”. If a technical error is detected by PHA, the request must not be stored in the task queue. The request must be rejected in an interactive mode.

- Query requirements

The users must be able to query the PHA task queue in order to monitor the processing. That means, that a user can enter a selection criterion and read the entries of all users of his institute. For example, concerning a task in the four eyes principle typically the second user

(not the user who captured the task) queries the task queue for the requests that have to be confirmed. In case of PHA, ICM creates a new request for the respective task queries concerning the PHA. Therefore, PHA must implement the related selection criteria for PHA tasks in its response to the request by ICM (see chapter C.b.g)).

C.a.d) Maximum response times of PHA

The U2A approach of ICM (with respect to the interaction between the user and ICM) acts on a real-time basis. To ensure a convenient operating for the interactive user, all responses from PHA must be returned as fast as possible. Taking into consideration

- the processing time within the SWIFT SIPN,
 - User to ICM
 - ICM to PHA
 - PHA to ICM
 - ICM to User
- the processing time within the ICM and
- the SWIFT timeout of 60 seconds concerning SWIFTNet InterAct in the SWIFT communication between the user and the ICM

a maximum response time for PHA of few⁴ seconds is required for the so called “loop” within the PHA:

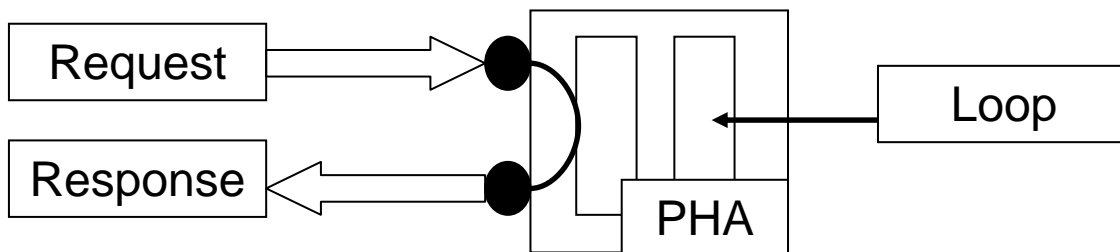

This is the time from the entrance of the request at the PHA site, the processing, till the return of the response back to the SWIFTNet. The initiation of a liquidity transfer is finished from the ICM point of view, when the response comes back to the user, indicating that the request will be executed. The final processing, i.e. the generating of a FIN message, is not subject to ICM.

C.b) ICM use cases for PHA

C.b.a) General remarks

The use cases in chapter C.b) identify, clarify and organise the system requirements in a methodology that is used in system analysis. The question whether the implementation of all use cases is mandatory should be decided by Level 2 bearing in mind that the full implementation would allow to offer a harmonised view to the users.

C.b.b) Issue account information

Aim	To read account information on the PHA account. ⁵
Precondition	Verification that the original request was sent by ICM with its specific DN.
Postcondition Success	The following information is issued: <ul style="list-style-type: none"> • Account Number of PHA account • Standing Order Liquidity Transfer

⁴ SWIFTNet Service Design Guide: The timeout period varies, depending on current network conditions at any precise moment. If a server application sends a response within 10 seconds or less there should be generally not be a problem with timeout conditions. However the overall service performance depends very much on the fact that servers respond quickly.

	<ul style="list-style-type: none"> • Current Balance • Blocked Amount
Postcondition Failure	An error message will be issued.

C.b.c) Issue credit line information

Aim	To read credit line information on the PHA account ⁵ .
Precondition	Verification that the original request was sent by ICM with its specific DN.
Postcondition Success	The following information is issued: <ul style="list-style-type: none"> • Credit Line
Postcondition Failure	An error message will be issued.

C.b.d) Transfer liquidity

Aim	To transfer liquidity with immediate effect.
Precondition	<ul style="list-style-type: none"> • Verification that the original task was sent by ICM with its specific DN. • NRE is given.
Postcondition Success	<ul style="list-style-type: none"> • The task was placed into the task queue. • A receipt stating the queue entry ID, the system time and a technical status code is issued. • Success status in the task queue.
Postcondition Failure	<ul style="list-style-type: none"> • An error message is issued. • Error status in the task queue.

C.b.e) Define/change standing order

Aim	To define and change a standing order in the PHA system for the liquidity transfer at the start of the business day.
Precondition	<ul style="list-style-type: none"> • Verification that the original task was sent by ICM with its specific DN. • NRE is given.
Postcondition Success	<ul style="list-style-type: none"> • The task was placed into the task queue. • A receipt stating the queue entry ID, the system time and a technical status code is issued. • Success status in the task queue.
Postcondition Failure	<ul style="list-style-type: none"> • An error message is issued. • Error status in the task queue.

⁵ The information referring PHA account can be requested via SD GetRTGSAccount/ReturnRTGSAccount. The relevant tags are displayed within the following elements:

<AcctLqdyRmvDaylight> = Account for Liquidity Removal Daylight

<AcctLqdyRmvEoD> = Account for Liquidity Removal End of Day

C.b.f) Issue system time

Aim	<ul style="list-style-type: none">• To read the current system time of the PHA system.• To test the availability of the system.
Precondition	-
Postcondition Success	Issue the system time of the PHA system.
Postcondition Failure	An error message is issued.

C.b.g) Issue task queue information

Aim	To read information regarding the processing of tasks in the PHA system. The following selections are possible: <ul style="list-style-type: none">• The entire task queue may be read.• A selection according to the following values is possible:<ul style="list-style-type: none">• Queue entry ID• Status
Precondition	Verification that the original request was sent by ICM with its specific DN.
Postcondition Success	The task queue information is issued. The task queue information includes the following values: <ul style="list-style-type: none">• Module: PHA• Queue entry ID• Status (e.g. confirmed, revoked etc.)• System time• User (last change)• Entry time Detailed information for reference: <ul style="list-style-type: none">• Task<ul style="list-style-type: none">• Amount• Liquidity Transfer• Change of standing order
Postcondition Failure	An error message is issued.

C.b.h) Create a task according to the four eyes principle

Aim	To create a task to be treated according to the four eyes principle.
Precondition	<ul style="list-style-type: none">• Verification that the original task was sent by ICM with its specific DN.• The segregation of duties is arranged for the task.
Postcondition Success	<ul style="list-style-type: none">• The task was placed into the task queue for confirmation.• A receipt stating the queue entry ID, the system time and a technical status code is issued.• Status "to confirm" assigned.

Postcondition Failure	An error message is issued.
------------------------------	-----------------------------

C.b.i) Confirm a task

Aim	To confirm a task, which has to be treated according to the four eyes principle.
Precondition	<ul style="list-style-type: none"> • Verification that the original task was sent by ICM with its specific DN. • NRE is given. • The status is “to confirm”. • The confirming user is not the initial creator of the task.
Postcondition Success	<ul style="list-style-type: none"> • The task is processed. • Status “waiting” assigned • A receipt stating the system time and a technical status code is issued (the queue entry ID has already been assigned to the original task).
Postcondition Failure	An error message is issued.

C.b.j) Revoke a task

Aim	To revoke a task with status „to confirm“.
Precondition	<ul style="list-style-type: none"> • Verification that the original task was sent by ICM with its specific DN. • NRE is given. • The status is “to confirm”.
Postcondition Success	<ul style="list-style-type: none"> • Status “revoked” assigned • A receipt stating the system time and a technical status code is issued (the queue entry ID has already been assigned to the original task).
Postcondition Failure	An error message is issued.

C.c) Structure of XML messages

C.c.a) General remarks

The XML messages that are exchanged between ICM and PHA⁶ are

- SWIFT cash management standard or
- so called proprietary TARGET2 messages.

In order to validate the XML messages which must be supported by PHA, the respective schema files are published on the TARGET2 website of the ECB:

<https://target2.ecb.int>

⁶ In case that debit accounts will not be filled from the A2A user to PHA, ICM takes care that the debited account at least will be filled by ICM.

Note: The website is password protected. A user-ID and a password is required to have access.

For a detailed description of Application headers respectively XML messages, please also refer to the dedicated chapters of this book.

C.c.b) Application Header

Each incoming and outgoing message contains an Application Header. The Application Header serves to transmit information on how to process the functional document. For the PHA communication two types of Application Headers are used:

- ApplicationHeaderPHAExtern (used for the message exchange between the user and ICM, thus not subject to this document)
- ApplicationHeaderPHAIntern

C.c.c) Document

C.c.c.a) General remarks

In the next subchapters the functional XML messages which must be supported by PHA are enumerated. **Due to customer related requirement and for smooth transition reasons, CAMT version 2012 (former CAMT version 5.0) and CAMT version 2017 are supported in parallel. CAMT version 4.0 is not supported any more.** If the XML request is based on version 2012 (5.0) the XML response message must relate to the same version. **The documentation within Book 4 is based on CAMT version 2017. The documentation of version 2012 (5.0) can be found in the prior version 11.01 of Book 4.** It is up to the CB to decide which version of CAMT will be supported. The standard to be used for PHA messages between CB's PHA and ICM, must be the lower version 2012 (5.0).

Please note: T2SI does only support the single version used by T2S (with go-live of T2S release 3.0 in June 2019 the actual supported camt version 2012 will be switched to camt version 2017 described in this book).

C.c.c.b) Account

Schema reference:

Request	ssp.pha.GetAccount.camt.003.001.05.xsd
Response	ssp.pha.ReturnAccount.camt.004.001.05.xsd
Request	ssp.pha.GetAccount.DRAFT1camt.003.001.06.xsd
Response	ssp.pha.ReturnAccount.DRAFT1camt.004.001.07.xsd

C.c.c.c) CreditLine

Schema reference

Request	ssp.pha.GetCreditLine.camt.998.001.02.xsd
Response	ssp.pha.ReturnCreditLine.camt.998.001.02.xsd
Request	ssp.pha.GetCreditLine.camt.998.001.03.xsd
Response	ssp.pha.ReturnCreditLine.camt.998.001.03.xsd

C.c.c.d) LiquidityCreditTransfer

Schema reference

Request	ssp.pha.LiquidityCreditTransfer.camt.050.001.03.xsd
Response	ssp.Receipt.camt.025.001.03.xsd
Request	ssp.pha.LiquidityCreditTransfer.DRAFT1camt.050.001.04.xsd
Response	ssp.Receipt.DRAFT1camt.025.001.04.xsd

C.c.c.e) ModifyStandingOrder

Schema reference

Request	ssp.pha.ModifyStandingOrder.camt.024.001.04.xsd
Response	ssp.Receipt.camt.025.001.03.xsd
Request	ssp.pha.ModifyStandingOrder.DRAFT1camt.024.001.05.xsd
Response	ssp.Receipt.DRAFT1camt.025.001.04.xsd

C.c.c.f) GetSystemTime

Schema reference

Request	ssp.GetSystemTime.camt.998.001.02.xsd
Response	ssp.ReturnSystemTime.camt.998.001.02.xsd
Request	ssp.GetSystemTime.camt.998.001.03.xsd
Response	ssp.ReturnSystemTime.camt.998.001.03.xsd

C.c.c.g) GetTask

Schema reference

Request	ssp.GetTask.camt.998.001.02.xsd
Response	ssp.ReturnTask.camt.998.001.02.xsd
	ssp.pha.LiquidityCreditTransfer.camt.050.001.03.xsd
	ssp.pha.ModifyStandingOrder.camt.024.001.04.xsd
Request	ssp.GetTask.camt.998.001.03.xsd
Response	ssp.ReturnTask.camt.998.001.03.xsd
	ssp.pha.LiquidityCreditTransfer.DRAFT1camt.050.001.04.xsd
	ssp.pha.ModifyStandingOrder.DRAFT1camt.024.001.05.xsd

C.c.c.h) ConfirmTask

Schema reference

Request	ssp.pha.ConfirmTask.camt.998.001.02.xsd
Response	ssp.Receipt.camt.025.001.03.xsd
Request	ssp.pha.ConfirmTask.camt.998.001.03.xsd
Response	ssp.Receipt.DRAFT1camt.025.001.04.xsd

C.c.c.i) RevokeTask

Schema reference

Request	ssp.pha.RevokeTask.camt.998.001.02.xsd
Response	ssp.Receipt.camt.025.001.03.xsd
Request	ssp.pha.RevokeTask.camt.998.001.03.xsd
Response	ssp.Receipt.DRAFT1camt.025.001.04.xsd

C.d) Handling of Errors

It may not always be possible to process a message at PHA side. Internal technical errors (e.g. temporary breakdown of PHA) or business errors (e.g. lack of liquidity on a PHA account) may result to a rejection of a message. If a request can not be executed, PHA has to send an error message to the ICM which must be forwarded to the user with the advice to wait a short time and to repeat the request/task. The error messages to be implemented by PHA are included in a dedicated chapter of this book.

C.e) SWIFTNet FIN

C.e.a) General remarks

As already mentioned in chapter A), it is understood that the communication infrastructure concerning SWIFTNet FIN already exists on PHA side. For the general aspects related to SWIFTNet FIN, please refer to chapter 9.1 of the UDFS, book 1.

C.e.b) Message Type (MT) 202

The only SWIFT message type that must be processed in the SWIFTNet FIN communication between PHA and TARGET2 in the context of liquidity transfers via ICM is MT 202. Y-Copy is foreseen for liquidity transfers from PHA to PM, whereas FIN is foreseen for liquidity transfers from PM to PHA.

D) Excursus: Insertion of PHA balances in the Reserve Management (RM) module

D.a) Business case

In order to ensure the calculation of the fulfilment of minimum reserve requirements by participants whose CB has opted for the RM module, it is necessary for the respective CB to send information about the end of day balance of accounts held at PHA to RM within the end-of-day-procedure.

D.b) Communication infrastructure requirements

D.b.a) Client-server interaction - graphical overview

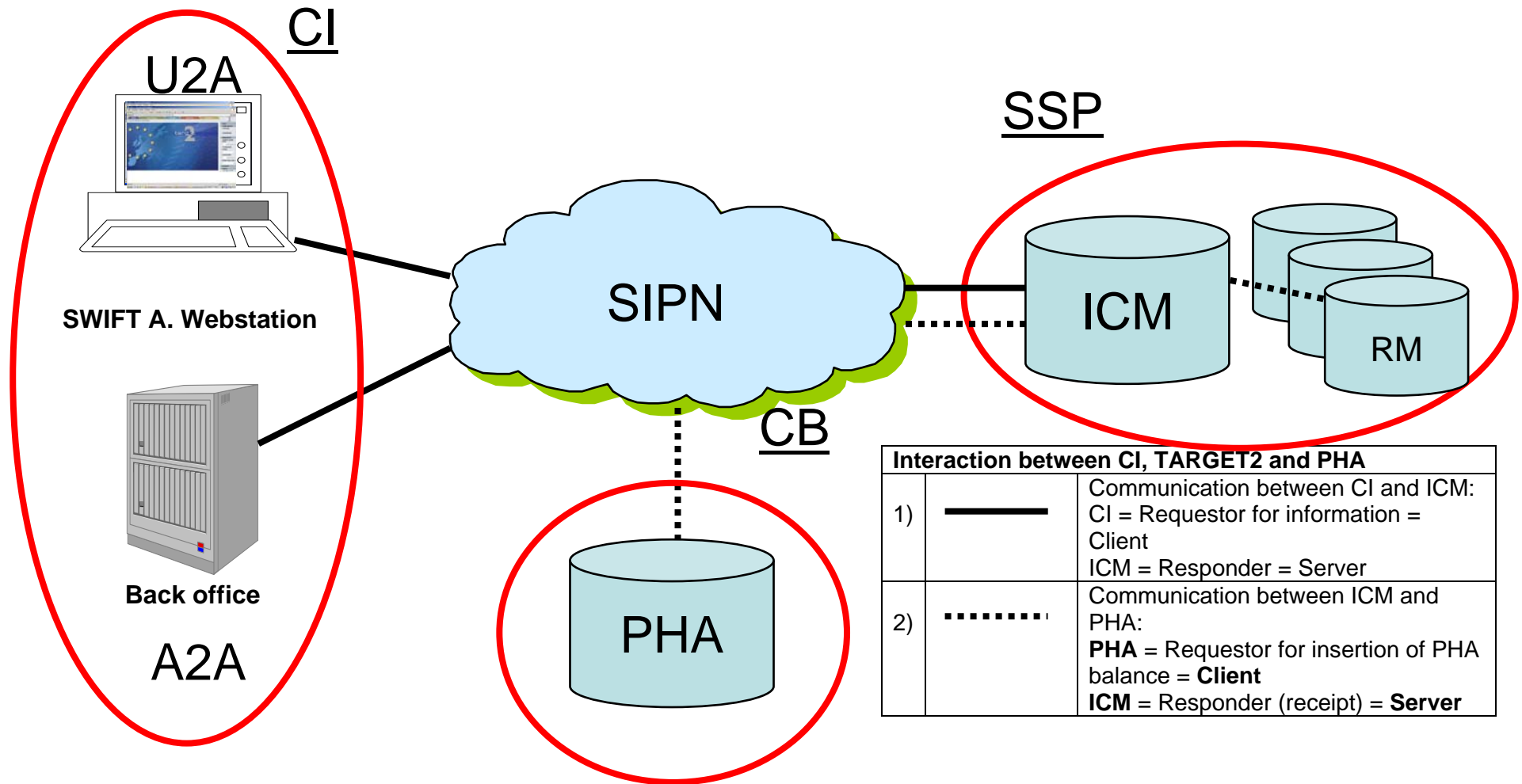

D.b.b) A2A approach

See chapter B.b).

D.b.c) SWIFT SIPN

D.b.c.a) Connectivity requirements

See chapter B.c.a).

D.b.c.b) Client-server model requirements

Unlike the client-server relationship described in chapter B.c.b), the PHA is the client sending a request to the ICM as the server, if the end of day PHA balances are transmitted by the CB to the ICM and then forwarded to the RM module. Therefore, a SWIFTNet **client** on PHA side is required to carry out the following tasks:

- Connection to the SWIFTNet
- Creation of the outgoing XML request (see chapter D.c.f))
- Dealing with the security features of SWIFTNet
- Acceptance and parsing of the XML response (receipt of the ICM if the task has been successfully placed in the task queue of RM, see chapter D.c.f))

The SWIFTNet client is an individual software application that the CB responsible for the PHA must implement and operate. The CB responsible for the PHA is fully responsible for the SWIFTNet client application.

D.b.c.c) Security requirements

D.b.c.c.a) Authorised access of ICM to PHA

For the interaction described in chapter D.b.a) the respective CBs must register the specific DN of the PHA for authorised access to the ICM.

D.b.c.c.b) Non-repudiation of emission (NRE)

See chapter B.c.c.b).

D.b.c.c.c) Usage of SWIFTNet InterAct

See chapter B.c.d).

D.b.c.c.d) SWIFT billing and pricing

See chapter B.c.e).

D.c) Application specification

D.c.a) Collaboration protocol

In the interaction described in chapter D.b.a), the protocol between PHA and ICM follows the protocol that is arranged between the protocol for the A2A users and ICM (see UDFS, book 4, chapter 2.1) without the simplifications mentioned in chapter C.a.a), as this is the common A2A communication.

D.c.b) Pull mode (Real Time Protocol)

The protocol applied between PHA and ICM in the interaction described in chapter D.b.a) also implies the so called pull mode. ICM forwards the XML request sent by the PHA to RM for processing. Requests will synchronously be answered with a response (receipt) by ICM if the task has been successfully placed in the task queue of RM. Due to the small data volume it is expected that the responses are always messages and never files.

D.c.c) No task queue at ICM side

No task queue is required at ICM side.

D.c.d) No Maximum response times of PHA

In the interaction described in chapter D.b.a), ICM respectively RM is the server/responder, whereas PHA is the client/requestor. Thus, maximum response times need not be defined for PHA in this case.

D.c.e) Use case: Insertion of PHA balance in RM

This use case is mandatory if the CB responsible for PHA has opted for the RM Module.

Aim	To insert the information of the end of day balance in the PHA account in the RM for the calculation of minimum reserves.
Precondition	<ul style="list-style-type: none">• Verification that the original request was sent by the required RBAC role.• NRE is given.
Postcondition Success	<ul style="list-style-type: none">• The following information is inserted in the RM:<ul style="list-style-type: none">• Participant BIC• End of day balance of PHA account.• A receipt stating the queue entry ID (of RM), the system time and a technical status code (of RM) issued by ICM is received by PHA.
Postcondition Failure	An error message (from ICM or RM) issued by ICM is received by PHA.

D.c.f) Structure of XML message InsertPHABalance

Schema reference

Request	ssp.rmm.InsertPHABalance.camt.998.001.02.xsd
Response	ssp.Receipt.camt.025.001.03.xsd
Request	ssp.rmm.InsertPHABalance.camt.998.001.03.xsd
Response	ssp.Receipt.DRAFT1camt.025.001.04.xsd

E) Further organisational and operational requirements for PHA

E.a) Testing

A separate test environment (beside the production environment) has to be provided by the CBs that allows to safely test and prove the correct interaction between ICM and the PHA. The following environments have to be provided:

- Integration
This environments will be used during the Level2 acceptance tests and during the customer testing phase to check connectivity. This environments will be connected to TARGET2 via the SWIFT Pilot Network.
- Production
The real working environment of the system. This environment will be connected to TARGET2 via the SWIFT Production Network.

E.b) Quality insurance

The connectivity of the ICM and the PHA has to be tested successfully. Furthermore, the CB responsible for the PHA has to confirm that the PHA can cope with the requirements specified in this document in an appropriate manner.

E.c) Support

To read information from PHA and to interact with PHA is similar to the behaviour vis-a-vis the TARGET2 modules. But the usability depends on:

- the performance of the connection between ICM and the PHA and
- the performance, stability and availability of the national PHA system

Therefore, the operating of the PHA must be ensured by the CBs. In particular, the CBs must constantly adapt to the evolution in the SWIFTNet, e.g. by upgrading the software and integrating new SWIFTNet releases.

E.d) Availability

The national PHAs must adapt to the business hours of TARGET2 for daytime processing and decide on their availability during night-time processing. Especially the Start of day- and the End of day-Procedures must comply with TARGET2. Moreover, the PHAs must support the TARGET2 calendar and thus operate on the same calendar days as TARGET2 (i.e. PHA must also be available during local holidays).

In addition, the CBs are strongly invited to maintain their existing access mode to their PHA system as a contingency solution in the situation if the link between ICM and PHA would be out of order.

E.e) Recovery time

An expected recovery time for PHA will be defined. This is the time from the alert till the solution of the problem on PHA side. A recovery time of 30 minutes is strongly recommended (maximum 2 hours) in order to ensure a high service quality for ICM.